

ALLGEMEINCHIRURGIE
GENERAL SURGERY
CIRUGÍA GENERAL
CHIRURGIA GENERALE



Reda Instrumente GmbH
Gänsäcker 34 · P.O. Box 131
D-78532 Tuttlingen

Telefon +49 / 74 62 / 94 45-0
Telefax +49 / 74 62 / 94 45-20
E-mail: info@Reda-Instrumente.de
<http://www.Reda-Instrumente.de>

Ausgabe Nr. 8
Datum: 06/2022



Charrière (Ch) French (F)	Durchmesser in mm	Inches
1	0,33	0,013
2	0,67	0,025
3	1,00	0,039
4	1,33	0,051
5	1,67	0,065
6	2,00	0,0787
7	2,33	0,092
8	2,67	0,105
9	3,00	0,1181
10	3,33	0,131
11	3,67	0,144
12	4,00	0,1575
13	4,33	0,170
14	4,67	0,184
15	5,00	0,1968
16	5,33	0,210
17	5,67	0,223
18	6,00	0,2362
19	6,33	0,249
20	6,67	0,263
21	7,00	0,2756
22	7,33	0,288
23	7,67	0,302
24	8,00	0,3150
25	8,33	0,328
26	8,67	0,341
27	9,00	0,3543
28	9,33	0,367
29	9,67	0,380
30	10,00	0,3973
31	10,33	0,407
32	10,67	0,420
34	11,33	0,446
36	12,00	0,4724
38	12,67	0,494
40	13,33	0,5199
45	15,00	0,5905

Gauge (G)	Durchmesser in mm	Inches
35	0,13	0,005
34	0,18	0,007
33	0,20	0,008
32	0,23	0,009
31	0,25	0,010
30	0,30	0,012
29	0,33	0,013
28	0,36	0,014
27	0,41	0,016
26	0,46	0,018
25	0,51	0,020
	0,53	0,021
24	0,56	0,022
23	0,64	0,025
22	0,71	0,028
21	0,81	0,032
20	0,89	0,035
	0,97	0,038
19	1,07	0,042
18	1,27	0,050
17	1,50	0,059
16	1,65	0,065
15	1,83	0,072
14	2,11	0,083
13	2,41	0,095
12	2,77	0,109
11	3,05	0,120
10	3,40	0,134
9	3,76	0,148
8	4,19	0,165
7	4,57	0,180
6	5,16	0,203

1 OZ	0,028 ml
5 OZ	0,140 ml
16 OZ	0,450 ml

35 OZ	1,0 l
128 OZ	3,7 l

GARANTIE / WARRANTY / GARANTIA / GARANZIA

GARANTIE

Wir gewähren auf alle **Reda**-Instrumente 5 Jahre Garantie. Voraussetzung ist der sach- und fachgerechte Einsatz der Instrumente. Von der Garantie sind Verschleißerscheinungen ausgeschlossen.

WARRANTY

Our **Reda** products are free from manufacturing defects in material and workmanship. We therefore give on all instruments a guarantee of five years provided that the instruments are maintained and cleaned properly and used normally for their intended purpose.

GARANTIA

Estamos convencidos de nuestra calidad y concedemos a todos los instrumentos de **Reda** 5 años de garantía contra cualquier defecto de fabricación, siempre y cuando se usen adecuadamente. De la garantía excluimos la manifestación de desgaste.

GARANZIA

Siamo convinti della nostra qualità e concediamo cinque anni di garanzia sulla funzione dei tutti gli strumenti **Reda** sotto la presupposizione che l'utilizzo è da esperto. Escluso della garanzia sono tracce di consumo.

Index

03: Diagnostik
05: Narkose
07: Skalpelle, Messer
09: Scheren
10: Mikroscheren
11: Pinzetten
12: Mikrochirurgie-Pinzetten

13: Klemmen
15: Tuchklemmen
17: Tupferzangen
19: Wundhaken
21: Sonden, Watteträger
23: Trokare, Biopsiekanülen, Führungsnadeln
25: Nadelhalter
27: Naht
29: Sterilisations-Instrumente

31: Verband, Gips
33, 34: Knochenchirurgie
41: Neurochirurgie
43, 44: Ophthalmologie
45: Otologie
47: Rhinologie
49: Mund und Zunge
51: Tonsillektomie
53: Laryngo-, Bronchoskopie
55: Tracheotomie
57: Thorax
61: Herz- und Gefäßchirurgie
63: Galle
65: Magen, Darm
67: Urologie
69: Rektum
71: Gynäkologie
73: Geburtshilfe
75: Dermatologie
89: Sterilisation, Behälter
91: Hochfrequenz-Chirurgie

Index

Diagnostic
Anesthesia
Scalpels
Scissors
Micro Scissors
Thumb and Tissue Forceps
Microsurgery Forceps
Atrauma Bulldog Clamps
Hemostatic Forceps
Towel Forceps
Dressing Forceps
Retractors
Probes, Cotton Applicators
Trocars

Needle Holders
Suturing Instruments
Sterilization Instruments

Plaster of Paris
Bone Surgery
Neurosurgery
Ophtalmology
Otology
Rhinology
Mouth and Tongue
Tonsils
Larynx
Tracheotomy
Thorax
Cardiovascular Surgery
Gall and Kidney
Intestines, Stomach
Urology
Rectum
Gynecology
Obstetrics
Dermatology, Hygiene
Different Containers
High Fequency Surgery

Indice

03:	Diagnóstico
05:	Anestesia
07:	Bisturíes
09:	Tijeras
10:	Tijeras p/micro cirugía
11:	Pinzas de disección
12:	Pinzas p/micro cirugía Clamp Atrauma Bulldog
13:	Pinzas hemostáticas
15:	Pinzas de campo
17:	Pinzas p/tapones
19:	Separadores
21:	Sondas, Porta-algodón
23:	Trócares
25:	Porta-agujas
27:	Instrumentos para sutura
29:	Instrumentos para la esterilización
31:	Vendajes enyesados
33, 34:	Cirugía ósea
41:	Neurocirugía
43, 44:	Oftalmología
45:	Otología
47:	Rinología
49:	Boca y lengua
51:	Amígdalas
53:	Laringe
55:	Traqueotomía
57:	Tórax
61:	Cirugía cardiovascular
63:	Vesícula biliar
65:	Intestinos, Estómago
67:	Urología
69:	Recto
71:	Ginecología
73:	Obstetricia
75:	Dermatología, Higiene
89:	Contenedores varios
91:	Electrocirugía

Index

Diagnostica
Anestesia
Bisturi
Forbici
Forbici per microchirurgia
Pinze per dissezione
Pinze per microchirurgia
Pinze Atrauma Bulldog
Pinze emostatiche
Pinze fissateli
Pinze per medicatura
Divaricatori
Sonde, Portacotone
Trequarti
Port'aghi
Strumenti per suture
Strumenti per la sterilizzazione
Bendaggi gessati
Chirurgia ossea
Neurochirurgia
Oftalmologia
Otologia
Rinologia
Bocca e lingua
Tonsille
Laringe
Tracheotomia
Torace
Chirurgia cardiovascolare
Vescicola biliare, rene
Intestini, Stomaco
Urologia
Retto
Ginecologia
Ostetrica
Dermatologia, Igiene
Vassoi diversi
Elettrochirurgia

Die Firma REDA Instrumente GmbH wurde im September 1990 gegründet. Ziel der Firmengründung war die Herstellung und der Vertrieb von chirurgischen Instrumenten.

Von anfangs 3 Mitarbeitern ist die Firma REDA innerhalb von sechs Geschäftsjahren zu einem mittelständischen Unternehmen gewachsen. Die Betriebsgröße beträgt heute mehr als 30 Mitarbeiter. Firma REDA exportiert in fast alle Länder der Welt und stellt dem Kunden weltweit Produkte und Dienstleistungen mit hoher Qualität zur Verfügung. Die Erwartungen der Kunden sollen stets erfüllt werden.

Um dieses zu erreichen, sind zufriedene und motivierte Mitarbeiter notwendig. Aus diesem Grund besitzen alle Mitarbeiter einen hohen Grad an Selbständigkeit und Eigenverantwortung für das Unternehmen. Darüber hinaus wird der familiäre Charakter seitens der Geschäftsführung unterstrichen und gefördert.

Der partnerschaftliche Stil setzt sich auch im hohen Maße bei den Geschäftsbeziehungen mit unseren Lieferanten und Kunden durch. Ziel ist es, Fehler zu vermeiden und kostenbewußt zu handeln.

Durch den Aufbau und den Unterhalt eines Qualitätsmanagementsystems nach den GMP regulation of the FDA, der DIN ISO 13485, Richtlinie 93/42 (MDR 2017/745) und die Zertifizierung des Systems wollen wir die erreichte Marktposition und Wettbewerbsfähigkeit halten und in der Zukunft weiter ausbauen.

In Zusammenarbeit mit Ärzten entwickeln, fertigen und vertreiben wir in den Bereichen:

- Allgemein- und Viszeralchirurgie
- Gefäß-, Mikro- und Neurochirurgie
- Herz- und Thoraxchirurgie
- Gynäkologie und Urologie
- HNO, Ophthalmologie
- Orthopädie
- Plastische Chirurgie
- Laparoskopie
- Endo-Neurochirurgie
- Arthroskopie
- Sinuskopie
- Cystoskopie
- Hysteroskopie
- Gynäkologie

Sehr gut ausgebildetes Personal und ein umfassender Maschinenpark ermöglichen es uns, die hohe Qualität und Präzision unserer Produkte umzusetzen und zu erreichen.

Unsere moderne EDV und die schlanke Organisation sind die wichtigsten Bestandteile unserer hohen Produktivität. Dadurch können wir unseren Kunden stets eine hohe Lieferbereitschaft und Flexibilität garantieren.

REDA Instrumente GmbH
Deutschland - Tuttlingen, 03/2022

REDA INSTRUMENTS GmbH was founded in September 1990. Starting with just three employees, REDA has grown within six years to a company who now employs over thirty people while still retaining the values of a family run business, and we pride ourselves on our customer service.

REDA exports to countries all over the world, offering to their customers a full range of surgical instruments.

REDA has a first class quality management system built upon the regulations of the FDA. In 1997 we became registered to DIN ISO 13485 and EEC 93/42 (MDR 2017/745).

REDA are able to offer a complete range of surgical instruments covering all types of surgery, including:

- General and Visceral Surgery
- Micro- Neuro- and Vascular Surgery
- Heart and Thorax Surgery
- Gynaecology
- ENT, Ophtalmology
- Orthopaedics etc.
- Laparoscopy
- Endo-Neurosurgery
- Arthroscopy
- Urology
- Gynaecology

We strive to offer first class products, manufactured by our highly trained precision engineers using most up to date C & C machines.

At our modern offices, together with modern technology, we can offer our customers a fast and efficient service from our large stocked warehouse.

REDA Instrumente GmbH
Deutschland - Tuttlingen, 03/2022

REDA Instrumente GmbH fundada en 1990 en Tuttlingen, Alemania, comenzó con éxito y con la intención de ocupar un lugar de privilegio como líder en la fabricación y venta internacional de instrumentos quirúrgicos de calidad superior.

Nuestra compañía comenzó con un pequeño staff integrado por el grupo familiar y fué creciendo con paso firme contando en la actualidad con un personal capacitado de aproximadamente 30 operarios y con presencia internacional a través de sus distribuidores en las principales capitales del mundo.

Un gran porcentaje de nuestra producción se compone de productos solicitados bajo características y marcas de nuestros clientes.

Con el objetivo de asegurar nuestro alto nivel de calidad nuestra empresa mantiene un staff muy entusiasta acompañado de una integrada relación con la gerencia, independencia en el empleo y motivación propia para el bienestar del personal.

Nos satisface trabajar junto a nuestros proveedores y en busca de un claro objetivo que nos permita lograr mutuos beneficios. Estamos seguros que éste sistema de trabajo nos permite evitar errores y lograr una mejor manufacturación de nuestros productos, la mayoría de ellos se diseñan con la colaboración y asesoramiento de médicos profesionales.

Nuestras especialidades en cirugía incluyen instrumentos para:

- cirugía general y visceral
- cirugía vascular, microcirugía, neurocirugía
- cirugía cardiovascular
- ginecología y urología
- ORL, Oftalmología
- Ortopedia
- cirugía plástica
- Laparoscopia
- Endo-neurocirugía
- Atroscopia
- sinuscopia
- cistoscopia
- histeroscopia
- ginecología

Estamos orgullosos de nuestra calidad, manteniendo periódicamente los tests correspondientes de GMP que exigen los standards regulares de agencias tales como la FDA, contando con las certificaciones de DIN ISO 13485 and EEC 93/42 (MDR 2017/745).

Desde los inicios, a través de modernos equipos computarizados logramos producir solamente instrumental de alta calidad.

REDA Instrumente GmbH
Deutschland - Tuttlingen, 03/2022

La REDA Instrumente GmbH fondata nel 1990 a Tuttlingen in Germania incominciò con l'intenzione di produrre e vendere strumenti chirurgici di qualità superiore sul mercato internazionale.

La nostra ditta incominciò con uno staff di 3 persone che attualmente è cresciuto a circa 30 persone con una presenza internazionale in tutti i paesi del mondo.

Una grande percentuale della nostra produzione è composta di prodotti richiesti a base caratteristiche e con il marchio dei nostri clienti.

Per poter assicurare il nostro alto livello di qualità la nostra impresa tiene uno staff molto entusiasta accompagnato da una relazione con la direzione, l'indipendenza e la propria motivazione per il benessere del personale.

Noi desideriamo lavorare in relazioni commerciali fra il fornitore ed il cliente, quale ci permette di ottenere un effetto utile reciproco. Siamo sicuri che questo tipo di collaborazione aiuta a limitare malintesi ed errori nella produzione e fornitura dei nostri prodotti. La maggiore parte dei nostri prodotti vengono sviluppati con la collaborazione di chirurghi professionali.

Le nostre specialità nella chirurgia includono strumenti per:

- Chirurgia generale e viscerale
- Micro chirurgia, neurochirurgia, chirurgia per vasi
- Chirurgia cardiovascolare e toracica
- Ginecologia e urologia
- ENT, oftalmologia
- Ortopedia
- Chirurgia plastica
- Laparoscopia
- Endo neurochirurgia
- Artroscopia
- Sinuscopia
- Cistoscopia
- Isteroscopia
- Ginecologia

Siamo orgogliosi della nostra qualità mantenuta periodicamente con i test corrispondenti agli standard GMP che mantengono o superano gli standard regolari come tali della FDA, la certificazione DIN ISO 13485 and EEC 93/42 (MDR 2017/745).

Il nostro sistema moderno computerizzato ci permette di produrre solamente strumenti di alta qualità.

REDA Instrumente GmbH
Deutschland - Tuttlingen, 03/2022

Blutdruckmeßgeräte
Sphygmomanometer
Esfigmomanómetros
Sfigmomanometri

big ben® DESK DESIGN



big ben® rund oder eckig - durchdachte Optionen für den täglichen Gebrauch. big ben® steht für Riester-Qualität, die hochwertigsten analogen Blutdruckmessgeräte für die präzise Blutdruckmessung. big ben® Blutdruckmessgeräte sind besonders große und robuste Geräte, die für den intensiven Einsatz in Arztpraxen und Krankenhäusern konzipiert sind.

- No. 03112-51 - Verbandmanschette, Erwachsene, rund
- No. 03112-52 - Hakenmanschette, Erwachsene, rund
- No. 03112-53 - Klettverschlussmanschette, Erwachsene, rund

big ben® round or square – well thought-out options for everyday use. big ben reflects Riester quality, the highest grade analogue sphygmomanometers for precise blood pressure measurement. big ben® sphygmomanometers are especially large and sturdy devices designed for intensive use in physicians' practices and hospitals.

- No. 03112-51 - Bandage cuff, adult, round
- No. 03112-52 - Hook cuff, adult, round
- No. 03112-53 - Velcro cuff, adult, round

big ben® redondo o cuadrado: opciones bien pensadas para el uso diario. big ben refleja la calidad de Riester, los esfigmomanómetros analógicos de mayor calidad para la medición precisa de la tensión arterial. Los esfigmomanómetros big ben® son aparatos especialmente grandes y robustos, diseñados para un uso intensivo en las consultas médicas y en los hospitales. diseñados para un uso intensivo en consultas médicas y hospitales

- No. 03112-51 - Brazaletes de venda, adulto, redondo
- No. 03112-52 - Brazaletes de gancho, adulto, redondo
- No. 03112-53 - Puño de velcro, adulto, redondo

big ben® rotondo o quadrato - opzioni ben ponderate per l'uso quotidiano. big ben rispecchia la qualità Riester, gli sfigmomanometri analogici di qualità superiore per una misurazione precisa della pressione sanguigna. sfigmomanometri analogici di altissima qualità per la misurazione precisa della pressione sanguigna. gli sfigmomanometri big ben® sono apparecchi particolarmente grandi e robusti dispositivi progettati per un uso intensivo negli studi medici e negli ospedali.

- No. 03112-51 - Bracciale a fascia, adulto, rotondo
- No. 03112-52 - Polsino a gancio, adulto, rotondo
- No. 03112-53 - Polsino in velcro, adulto, rotondo

Blutdruckmeßgeräte
Sphygmomanometer
Esfigmomanómetros
Sfigmomanometri

big ben® WALL DESIGN



big ben® rund oder eckig - durchdachte Optionen für den täglichen Gebrauch. big ben® steht für Riester-Qualität, die hochwertigsten analogen Blutdruckmessgeräte für die präzise Blutdruckmessung. big ben® Blutdruckmessgeräte sind besonders große und robuste Geräte, die für den intensiven Einsatz in Arztpraxen und Krankenhäusern konzipiert sind.

No. 03114-57 - Verbandmanschette, Erwachsene, rund

No. 03114-58 - Hakenmanschette, Erwachsene, rund

No. 03114-59 - Klettverschlussmanschette, Erwachsene, rund

big ben® round or square – well thought-out options for everyday use. big ben reflects Riester quality, the highest grade analogue sphygmomanometers for precise blood pressure measurement. big ben® sphygmomanometers are especially large and sturdy devices designed for intensive use in physicians' practices and hospitals.

No. 03114-57 - Bandage cuff, adult, round

No. 03114-58 - Hook cuff, adult, round

No. 03114-59 - Velcro cuff, adult, round

big ben® redondo o cuadrado: opciones bien pensadas para el uso diario. big ben refleja la calidad de Riester, los esfigmomanómetros analógicos de mayor calidad para la medición precisa de la tensión arterial. Los esfigmomanómetros big ben® son aparatos especialmente grandes y robustos, diseñados para un uso intensivo en consultas médicas y hospitales. especialmente grandes y robustos, diseñados para un uso intensivo en consultas médicas y hospitales.

No. 03114-57 - Brazaletes de venda, adulto, redondo

No. 03114-58 - Brazaletes de gancho, adulto, redondo

No. 03114-59 - Puño de velcro, adulto, redondo

big ben® rotondo o quadrato - opzioni ben ponderate per l'uso quotidiano. big ben rispecchia la qualità Riester, gli sfigmomanometri analogici di qualità superiore per una misurazione precisa della pressione sanguigna. sfigmomanometri analogici di altissima qualità per la misurazione precisa della pressione sanguigna. gli sfigmomanometri big ben® sono apparecchi particolarmente grandi e robusti dispositivi progettati per un uso intensivo negli studi medici e negli ospedali.

No. 03114-57 - Bracciale a fascia, adulto, rotondo

No. 03114-58 - Polsino a gancio, adulto, rotondo

No. 03114-59 - Polsino in velcro, adulto, rotondo

Blutdruckmeßgeräte
Sphygmomanometer
Esfigmomanómetros
Sfigmomanometri

MINIMUS III



Weltweit bekanntes und beliebtes Einhandmodell. Verchromtes Metallgehäuse. Spezialgehärtete Kupfer-Beryllium Membrane. Keine Nullpunktfixierung. Gut ablesbare Aluminiumskala \varnothing 49 mm bis 300 mmHg. Löffel aus rostfreiem Stahl. Latexball und verchromtes Abbläsventil. Zwei verchromte Schlauchverschraubungen an der rechten Seite unterhalb des Manometers. In Vinyltasche mit Reißverschluss. Maximale Fehlertoleranz des Gerätes: \pm 3 mmHg.

Nr. 03133-00 - Mit Wickelmanschette aus Baumwolle, komplett mit Latexpolster mit Doppelschlauch.

Nr. 03133-01 - Mit Hakenmanschette aus Baumwolle, komplett mit Latexpolster mit Doppelschlauch.

World-famous and popular palm-style sphygmomanometer. Chrome-plated metal housing with 2 chromed-tube connections at lower right. Special tempered copper-beryllium diaphragm. No stop pin. Easy-to-read graduated aluminium scale \varnothing 49 mm. Maximum reading 300 mmHg. Stainless steel handle. With latex bulb and chrome-plated air release valve. In vinyl zipper case. Maximum error \pm 3 mmHg throughout range.

No. 03133-00 - With cotton bandage cuff, complete with double-tube latex bladder.

No. 03133-01 - With cotton hook cuff, complete with double-tube latex bladder.

Modelo de mano, conocido en el mundo entero y de gran aceptación. Caja metálica cromada donde se aloja el mecanismo. Membrana cobreberilio endurecido especial. Sin fijación a cero. Buena lectura de la escala aluminio \varnothing 49 mm hasta 300 mmHg. Cuchara de acero inoxidable. Pera latex y válvula cromada. Dos atornilladuras de tubo cromadas al lado derecho debajo del manómetro. En estuche vinilo con cierre de cremallera. Tolerancia de errores máxima: \pm 3 mmHg.

No. 03133-00 - Con brazaletes de venda de algodón, completo con bolsa de latex doble tubos.

No. 03133-01 - Con brazaletes de ganchos de algodón, completo con bolsa de latex doble tubos.

Sfigmomanometro ad aneroidi di fama mondiale. Manometro in metallo cromato con uscita cromata laterale (in basso a destra) per collegamento a due tubi. Membrana speciale di rame-berillio indurito. Senza fissaggio a zero. Scala graduata in alluminio \varnothing 49 mm di facile lettura. Valore massimo 300 mmHg. Manico in acciaio inossidabile. Con monopalla di latex e valvola di sfiato cromata. Fornito in borsa vinilpelle con cerniera lampo. Tolleranza \pm 3 mmHg.

No. 03133-00 - Con bracciale di cotone a fascia, completo di camera d'aria di latex a 2 tubi.

No. 03133-01 - Con bracciale di cotone a ganci, completo di camera d'aria di latex a 2 tubi.

Diagnostik-Bestecke mit Standardbeleuchtung
Diagnostic Sets with Standard illumination
Estuches de diagnóstico con iluminación standard
Combinazioni per diagnostica con illuminazione standard

UNI I

Nr. 03161-00

Weltbekanntes und preiswertes Otoskop mit Standardbeleuchtung 2,5 V. Besonders geeignet für Studenten und Ärzte.

Set bestehend: Aus **Otoskopkopf** verchromt, mit Steckverschluss. **Verchromter Batteriegriff 28 mm ø** für 2 Batterien Typ C. Mit abnehmbarem Abdeckglas in Kunststoff-Fassung mit Plastikconnector für den pneumatischen Test. Die verchromte Schwenklinse ist abnehmbar und vergrößert 4,0-fach. Die Lichtstärke kann anhand des Rheostates reguliert werden. Mit 3 wiederverwendbaren Ohrtrichtern 2, 3 und 4 mm ø. Komplett in silberfarbener Kunststofftasche.

No. 03161-00

World famous otoscope set at a budget price for physicians and students. 2,5 V standard illumination for use with 2 batteries type C.

Set includes: **Otoscope head** with pin contact fitting. Chrome-plated. Fixed protective lens in plastic mount may be removed for introduction of instruments. Plastic connector for pneumatic otoscopy. Removable swivel-mounted 4 x magnifier. 2, 3 and 4 mm reusable specula included. **Battery handle 28 mm ø** for 2 C-cell batteries. Chrome-plated. With thumb wheel for securing pin contact heads. With rheostat for adjustment of illumination. Complete in silver-colored plastic pouch.

No. 03161-00

Otoscopio muy popular y económico con iluminación standard 2,5 V apropiado para estudiantes y médicos, de fama mundial.

Cabeza otoscopio cromada, con cierre de tornillo. **Mango a pilas cromado 28 mm ø** para dos pilas tipo C. Con cristal de cubierto desmontable en armadura plástica. Con conector plástico para el test neumático. La lente giratoria es desmontable y amplifica 4,0 veces mas. La intensidad de la luz es regulable con el reostato. Con tres espejos reutilizables 2, 3 y 4 mm ø. Completo en bolsa de plástico de color gris plata.

No. 03161-00

Set otoscopio di fama mondiale ad un prezzo economico per medici e studenti. Illuminazione standard 2,5 V per l'uso con 2 batterie tipo C.

Il set include: Testa dell'otoscopio con raccordo di contatto a perno. Cromato. Lente protettiva fissa in supporto di plastica che può essere rimossa per l'introduzione degli strumenti. Connettore in plastica per otoscopia pneumatica. Lente d'ingrandimento 4 x rimovibile e girevole. 2, 3 e 4 mm specula riutilizzabile inclusa. Impugnatura della batteria 28 mm ø per 2 batterie C-cell. Cromato. Con rotella per fissare le teste di contatto teste di contatto. Con reostato per la regolazione dell'illuminazione.

Diagnostik-Bestecke mit Standardbeleuchtung
 Diagnostic Sets with Standard illumination
 Estuches de diagnóstico con iluminación standard
 Combinazioni per diagnostica con illuminazione standard

UNI II



Nr. 03161-01

Weltbekanntes und preisgünstiges **May-Ophthalmoskop**: mit Standardbeleuchtung 2,5 V. Besonders für Studenten und Ärzte geeignet. Ophthalmoskop mit Steckverschluß. Anhand des Linsenrades können Korrekturlinsen von 0 bis +20 und 0 bis -20 Dioptrien gewählt werden. Mit einer Blende: großer Kreis. Mit verchromtem **Batteriegriff**: 28 mm ø für 2 Batterien Typ C. Die Lichtstärke kann anhand des Rheostates reguliert werden. Komplett in silbergrauer Kunststofftasche.

No. 03161-01

World-famous ophthalmoscope set at a budget price for physicians and students. 2,5 V standard illumination for use with 2 batteries Type C. Set includes: **May ophthalmoscope head**: Pin contact fitting. Lens selection wheel permits choice of corrective lenses from 0 to +20 and 0 to -20 diopters. Single large circle aperture. **Battery handle**: 28 mm ø for 2 C-cell batteries. Chrome-plated. With thumb wheel for securing pin-contact heads. Rheostat for adjustment of illumination. Complete in silver-gray plastic pouch.

No. 03161-01

Oftalmoscopio May: muy popular y económico con iluminación standard 2,5 V, apropiado para estudiantes y médicos de fama mundial. Oftalmoscopio con cierre de tornillo. Con ayuda de la rueda de lentes se puede elegir lentes de corrección de 0 a +20 y o a -20 dioptrías. Y con una apertura: gran círculo. Con **mango a pilas**: cromado 28 mm ø para dos pilas tipo C. La intensidad de la luz es regulable con el reostato. Completo en bolsa de plástico de color gris plata.

No. 03161-01

Set oftalmoscopio di fama mondiale ad un prezzo economico per medici e studenti. Illuminazione standard 2,5 V per l'uso con 2 batterie tipo C. Il set include: Testa dell'oftalmoscopio di maggio: Raccordo di contatto a spillo. La ruota di selezione delle lenti permette di scegliere le lenti correttive da 0 a +20 e da 0 a -20 diottrie. Apertura a cerchio unico grande. Impugnatura della batteria: 28 mm ø per 2 batterie a celle C. Cromato. Con rotella per il fissaggio delle teste di contatto a perno. Reostato per la regolazione dell'illuminazione. Completo in astuccio di plastica grigio argento.

Diagnostik-Bestecke mit Standardbeleuchtung
 Diagnostic Sets with Standard illumination
 Estuches de diagnóstico con iluminación standard
 Combinazioni per diagnostica con illuminazione standard

UNI III



Nr. 03161-02

Weltbekanntes diagnostisches Besteck mit Standardbeleuchtung 2,5 V. Äußerst beliebt und sehr preiswert. Besonders geeignet für Studenten und Ärzte. Das Set besteht aus folgenden Teilen: **Otoskopkopf** verchromt, mit Steckverschluss. Abnehmbares Abdeckglas in Kunststofffassung, mit Plastikkonnekter für pneumatischen Test. Abnehmbarer Schwenklinse (Vergrößerung 4,0-fach). 3 wiederverwendbaren Ohrtrichtern 2, 3 und 4 mm ø. **May-Ophthalmoskop** mit Steckverschluss. Anhand des Linsenrades können Korrekturlinsen von 0 bis +20 und 0 bis -20 Dioptrien gewählt werden. Mit einer Blende: großer Kreis. **Batteriegriff** verchromt, 28 mm ø für 2 Batterien Typ C. Die Lichtstärke kann anhand des Rheostates am Batteriegriff reguliert werden. Alle Teile komplett in silbergrauer Kunststofftasche.

No. 03161-02

World-famous otoscope/ophthalmoscope diagnostic set at a budget price for physicians and students. 2,5 V Standard illumination for use with 2 batteries type C. Set includes: **Otoscope head** - Pin contact fitting. Chrome-plated. Fixed protective lens in plastic mount may be removed for introduction of instruments. Plastic connector for pneumatic otoscopy. Removable swivel-mounted 4 x magnifier. 2, 3 and 4 mm reusable specula included. **May ophthalmoscope head**. Pin contact fitting. Lens selection wheel permits choice of corrective lenses from 0 to +20 and 0 to -20 diopters. Single large circle aperture. **Battery handle**. 28 mm ø for 2 C-cell batteries. Chrome-plated. With thumb wheel for securing pin-contact heads. Rheostat for adjustment of illumination.

No. 03161-02

Este estuche de diagnóstico con iluminación standard 2,5 V es muy popular y muy económico, apropiado para estudiantes y médicos. Juego, compuesto de: **Cabeza otoscopio** cromado, con cierre de tornillo. Con cristal de cubierto en armadura plástica, con conector plástico para el test neumático. Con lente giratorio desmontable (amplificación: 4 veces más). **Cabeza oftalmoscopio May** con cierre de tornillo. Con ayuda de la rueda de lentes se puede elegir lentes de corrección de 0 a +20 y 0 a -20 dioptrías. Con una apertura: gran círculo. **Mango a pilas** cromado, 28 mm ø para dos pilas tipo C. La intensidad de la luz es regulable con el reostato al tope del mango. Todos los partes se presentan en una bolsa plástica de color gris plata.

No. 03161-02

Combinazione per diagnostica otoscopio/oftalmoscopio a prezzo economico, per ambulatori e studenti. Illuminazione standard 2,5 V con 2 batterie tipo C. La combinazione comprende: Testa otoscopio - Chiusura a vite. Cromata. La lente di protezione fissa in supporto di plastica può essere tolta per l'inserimento di strumenti. Connettore di plastica per test pneumatico. Lente d'ingrandimento 4 x in montatura girevole estraibile. Inclusi specchi da 2, 3 e 4 mm riusabili. Oftalmoscopio May. Chiusura a vite. La rotella di selezione permette la scelta di lenti di correzione da 0 a +20 e da 0 a -20 diottrie. Apertura singola a cerchio grande. Manico a pila ø 28 mm con 2 batterie tipo C. Cromato. Con ruota ad orlo zigrinato per fissare la testa dell'otoscopio con chiusura a vite. Reostato per la regolazione dell'illuminazione. Fornita in busta di plastica colore grigio argento.

Diagnostik-Bestecke mit Standardbeleuchtung
 Diagnostic Sets with Standard illumination
 Estuches de diagnóstico con iluminación standard
 Combinazioni per diagnostica con illuminazione standard



ECO "T" 03161-03C

- a) Otoskop, mit Schraubverschluss und 3 Ohrtrichtern, 2-3-4 mm
 Otoloscope with screw fitting and 3 ear speculas with, 2-3-4 mm
 Otoscopio, con cierre a tornillo y con 3 espéculos auriculares de 2-3-4 mms
 Testa otoscopio: chiusura a vite, connettore di plastica per test pneumatico,
 3 specoli (2, 3 e 4 mm) riutilizzabili, lente di protezione da togliere
- b) Oftalmoskop, 0 bis +20 und 0 bis -20 Dioptrien, mit Schraubverschluss
 Ophthalmoscope from 0 to +20 and 0 to -20 dioptries with screw fitting
 Oftalmoscopio, 0 a + 20 y 0 a - 20 dioptrias, con cierre a tornillo
 Testa oftalmoscopio: chiusura a vite, lenti di correzione da 0 a +20 e da 0 a -20 diottrie.
- c) Nasenspekulum
 Nasal Speculum
 Espéculo nasal
 Specoli nasali divaricabili
- d) Lampenträger mit Schraubverschluss
 Bent arm illuminator with screw fitting
 Porta-lámpara, con cierre a tornillo
 Porta lampada con 2 specchi laringei, misura 3 e 4.
- e) 2 Kehlkopfspiegel No. 3 und 4
 2 laryngeal mirrors no. 3 and 4
 Espejos laringeos Nos. 3 y 4
 Porta lampada con 2 specchi laringei, misura 3 e 4.
- f) Mundspatelhalter
 Tongue blade holder
 Abaja-lenguas
 Porta abbassa-lingua
- g) Batteriegriff für 2 Batterien mit Schraubverschluss (ohne Batterien)
 Battery handle for 2 batteries
 Mango para 2 pilas, con cierre a tornillo (sin pilas)
 Manico a pila (senza pila), illuminazione regolabile
- h) Ersatzlämpchen 2.5 V
 Spare lamp 2.5 V
 Bombillo de repuesto 2.5 V
 Lampadina di ricambio

Diagnostik-Bestecke mit Standardbeleuchtung
 Diagnostic Sets with Standard illumination
 Estuches de diagnóstico con iluminación standard
 Combinazioni per diagnostica con illuminazione standard



Kleine, sehr moderne Qualitätsinstrumente aus Kunststoff, grau, mit Xenonbeleuchtung XL 2,5 V. Sehr preiswert und aufgrund der Größe besonders gut für die Arzttasche geeignet. Schraubverschluss. **Otoskop:** Fiber-Optik. Anschluß für pneumatischen Test. Lupe vergrößert 2,5-fach. Batteriegriff für 2 Batterien Typ AA. **Ophthalmoskop:** Korrekturlinsen: 0 bis +20 und 0 bis -20 Dioptrien. Blenden: Kreis groß + klein, Halbkreis, Fixierstern und Grünfilter. Griff für 2 Batterien Typ AA. Das Otoskop- und das Otoskop/Ophthalmoskop-Besteck werden jeweils mit einem Metallkonnektor für pneumatischen Test und Plastikröhrchen mit jeweils 5 wiederverwendbaren Ohrtrichtern 2,5 und 4,0 mm geliefert. Komplet in modernem schwarzen Kunststoffetui.

Nr. 03171-00 - Otoskop mit Griff AA.

Nr. 03171-01 - Ophthalmoskop mit Griff AA.

Nr. 03171-02 - Otoskop/Ophthalmoskop jeweils mit Griff AA.

Economically priced state-of-the-art quality instrument made of plastics, gray color, with Xenon illumination XL 2,5 V. Due to its small size it is most suitable for each practitioner's bag. **Otoscope:** Fiber optic. Screw type fitting. 2,5 x magnifying glass. Battery handle for 2 AA-cell batteries. **Ophthalmoscope:** Corrective lenses ranging from 0 to +20 and 0 to -20 diopters. Apertures: large and small circle, semi-circle, fixation star and green filter. Otoloscope and otoscope/ophthalmoscope set each contain a metal connector for pneumatic otoscopy as well as plastic tube with 5 each reusable ear specula 2,5 and 4,0 mm. All sets come in modern black plastic case.

No. 03171-00 - Otoloscope with AA-handle.

No. 03171-01 - Ophthalmoscope with AA-handle.

No. 03171-02 - Otoloscope/ophthalmoscope with 1 each AA-handle.

Instrumentos de calidad, muy moderno y pequeño de plástico resistente, gris, con iluminación Xenon XL 2,5 V. Muy económico y gracias al tamaño apropiado para el bolsillo del médico. Cierre roscado. **Otoscopio:** fibra óptica. Conexión para test neumático. Lupa aumenta 2,5 veces más. Mango a pilas para 2 pilas, tipo AA. **Oftalmoscopio:** Lentes de corrección: 0 hasta +20 y o hasta -20 dioptrías. Aberturas: círculo grande y pequeño, semicírculo, estrella fijadora y filtro verde. Con mango para 2 pilas, tipo AA. Juego de otoscopio y de otoscopio/oftalmoscopio con conector metálico para el test neumático y con 5 espéculos reutilizables de 2,5 y 4,0 mm en tubito de plástico. Todos los juegos se presentan en estuche de plástico negro moderno.

No. 03171-00 - Otoscopio con mango AA.

No. 03171-01 - Oftalmoscopio con mango AA.

No. 03171-02 - Oto/oftalmoscopio con mangos AA.

Strumento piccolo, moderno, di alta qualità realizzato in plastica, grigio, con illuminazione Xenon XL 2,5 V. Molto economico e, date le sue dimensioni, il più adatto a stare nella borsa del medico. Otoscopio: con attacco a vite. Lente d'ingrandimento 2,5X. Manico a pila per 2 batterie tipo AA. Oftalmoscopio: Lenti correttive da 0 a +20 e da 0 a -20 diottrie. Aperture: a cerchio grande e piccolo, semicerchio, a stella, filtro verde. Con manico per 2 batterie tipo AA. L'otoscopio e la combinazione otoscopio/oftalmoscopio hanno un connettore per test pneumatico e tubo di plastica con 5 specoli auricolari 2,5 e 4,0 mm. cad. Tutte le combinazioni sono fornite in un moderno astuccio di plastica nera.

No. 03171-00 - Otoscopio con manico AA.

No. 03171-01 - Oftalmoscopio con manico AA.

No. 03171-02 - Oto/Oftalmoscopio con manici AA.

Nystagmusbrille
 Nystagmus spectacles
 Anteojos para nistagmo
 Occhiali nistagmo



FRENZEL

03167-03
 Beleuchtete Nystagmusbrille
 mit querliegendem Batterie-
 handgriff und festen Gläsern

Energiequelle:
 2 Stück 4-Volt-Lämpchen
 2 Stück Baby-Zellen 1.5 V

03167-03
 Anteojos para nistagmo, con
 iluminación, con mango para
 pilas en forma horizontal, vidrios
 fijos,

Alimentación:
 2 unidades de bombillos de
 4 voltios
 2 unidades de pilas de
 1.5 voltios

03167-03
 Nystagmus spectacles for
 observation of the eyes during
 examination of the vestibular
 apparatus, with battery handle
 and fixed glasses. Illuminated
 on inside of lenses.

Source of energy:
 2 bulbs 4-volt
 2 baby-battery cells 1.5 V

03167-03
 Occhiali Nistagmo illuminati
 con manipoło a batteria,
 lenti fisse.
 Per la rilevazione della reazione
 patologica del nistagmo.

Alimentazione:
 2 lampadine 4 Volt
 2 batterie 1,5 Volt

Stirnspiegel
Head Mirror
Espejos frontales
Specci frontali



03180-93
ø 90 mm



ZIEGLER
03180-90
compl.



03180-92

03180-90
Ziegler-Stirnspiegel,
komplett, mit schwarzem
Stirnreifen,
mit Kugelgelenk,
90 mm ø

03180-90
Ziegler Head Mirror,
complete with black head
band, with ball socket,
90 mm ø

03180-90
Ziegler espejo frontal, comple-
to con cinta negra,
con articulación,
90 mm ø

03180-90
Specchio frontale, Ziegler,
completo con fascia nera,
con snodo sferico,
90 mm di ø

03180-92
Stirnreifen, allein

03180-92
head band, only

03180-92
cinta, suelta

03180-92
fascia, sola

03180-93
Spiegel, allein
90 mm ø

03180-93
Mirror, only
90 mm ø

03180-93
Espejo, suelto
90 mm ø

03180-93
Specchio,
solo 90 mm ø

Stirnlampe
Head Light
Lámpara frontal
Lampada frontale



CLAR
03195-00

komplett mit Stirnstreifen und Kabel
complete with head band and cable
completo con cinta frontal y cable
completa con fascia frontale e cordone



03195-01
ø 55 mm

Spiegel aus Glas ohne Fassung
Glass Mirror without frame
Reflector de cristal, sin montura
Riflettore di cristallo, senza montatura



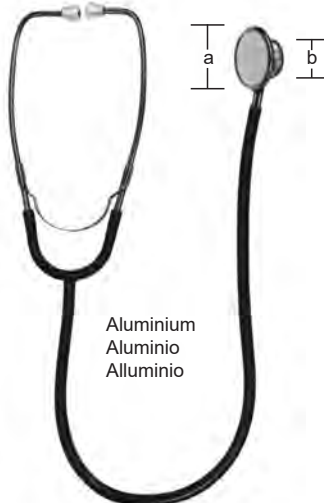
03195-06
6 Volt



03195-07 Kleintransformator
220 Volt = 0 - 10 Volt / 3 Watt
Mini-Transformer Unit
Transformador eléctrico pequeño
Mini-trasformatore elettrico

03195-08 Kleintransformator
110 Volt = 0 - 10 Volt / 3 Watt
Mini-Transformer Unit
Transformador eléctrico pequeño
Mini-trasformatore elettrico

Stethoskope
Stethoscopes
Estetoscopios
Stetoscopi



Aluminium
Aluminio
Alluminio

DUPLEX



Aluminium
Aluminio
Alluminio

ANESTOPHON
03248-00

	a	b	
03246-00	48 mm, 1.9"	30 mm, 1.2"	
03246-01	39 mm, 1.5"	25 mm, 1.0"	Baby
03246-02	21 mm, 0.8"	21 mm, 0.8"	Neonatal



PINARD
03260-15 15 cm, 6"
ALU



PINARD
03262-18 18 cm, 7"
Holz, wood, maderas, legno

Perkussionshämmer
 Percussion Hammers
 Martillos de percusión
 Martelli da percussione



TAYLOR - USA Mod.
 03288-17 17 cm, 6 ³/₄"
 03288-20 20 cm, 8"



BABINSKY
 03292-22 22 cm, 8 ³/₄"



TROEMNER
 03294-24



DEJERINE
 03304-20 20 cm, 8"



BERLINER
 03306-17 17 cm, 6 ³/₄"



BUCK
 03308-18 18 cm, 7"

Prüf- und Meßinstrumente
 Examination and Measuring Instruments
 Instrumentos para exámenes y medidas
 Strumenti per esaminare e misurare

Dynamometer
 Dynamometer
 Dinamómetro
 Dinamometro



COLLIN
 03310-01 Erwachsene, Adult,
 adultos, adulti
 03310-02 Kind, child, niños, bambini

Winkelmesser
 Goniometer
 Goniómetro
 Goniometro



MOELTGEN
 03312-01



Finger-Goniometer
 Finger goniometer
 Goniómetro para dedos
 Goniometro per le dita
 03314-01



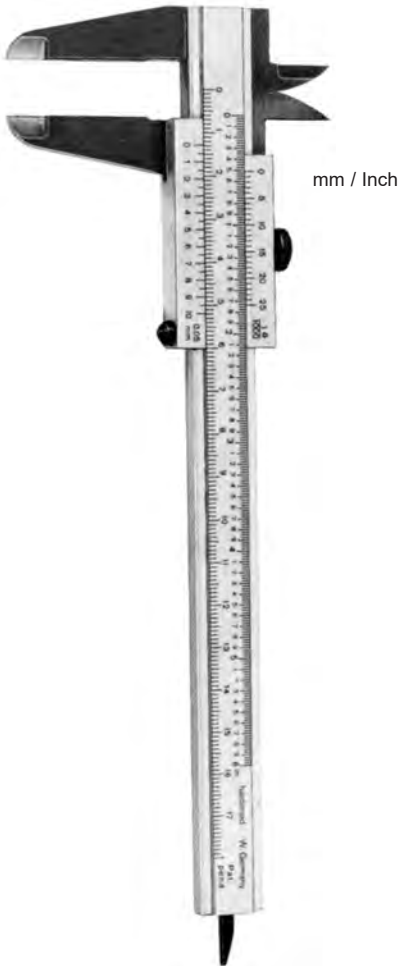
WARTENBERG
 03320-19 18 cm, 7"

mm / Inch

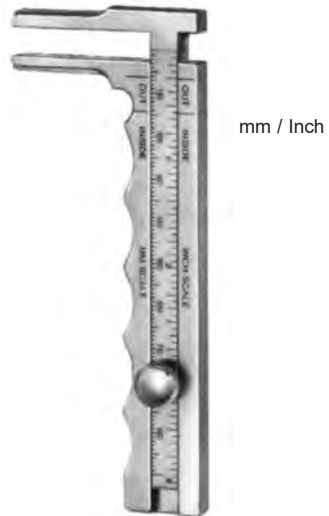


Metall		
03340-10	10 cm	4"
03340-15	15 cm	6"
03340-20	20 cm	8"
03340-30	30 cm	12"
03340-50	50 cm	20"

Schieblehren
Calipers
Calibres
Calibro



03360-21
21 cm, 8 1/4"



TOWNLEY
03361-10
11,5 cm, 4 1/2"

Saugrohre
Suction tubes
Tubos de aspiración
Cannule per aspirazione



POOLE 20 cm, 8"
05130-05 5.5 mm ø, 0.2"
(17 Fr.)

05130-10 10 mm ø, 0.4"
(30 Fr.)



POOLE 19 cm, 7 1/2"
05140-05 5.5 mm ø, 0.2"
(17 Fr.)

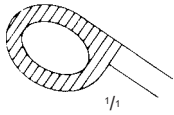
05140-08 8 mm ø, 0.3"
(23 Fr.)



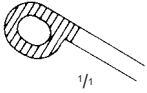
BABY-YANKAUER
05150-21 21 cm, 8 1/4"

YANKAUER
27 cm, 10 1/2"
05150-27 Ø 2,0 mm
05150-48 Ø 4,8 mm

Kathetereinführzangen, Saugrohre
 Catheter Introducing Forceps, Suction tubes
 Pinzas para catéteres, Tubos de aspiración
 Pinze per introdurre le sonde, Cannule per aspirazione



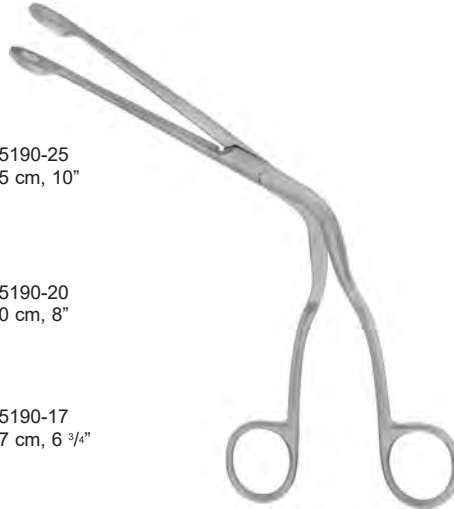
05190-25
25 cm, 10"



05190-20
20 cm, 8"



05190-17
17 cm, 6 3/4"



MAGILL



ANDREW-PYNCHON
05170-24
6 mm \varnothing , 1/2"
24 cm, 9 1/2"



COOLEY
05160-02
8 mm \varnothing , 0.3"
36 cm, 14 1/4"



COOLEY
05160-03
8 mm \varnothing , 0.3"
30 cm, 11 3/4"



DE BAKEY
05160-04
3 mm \varnothing , 0.1"
27 cm, 10 1/2"

\varnothing 15 mm



\varnothing 9 - 13 mm

FINSTERER
05180-32
32 cm, 12 3/4"

Kaltlicht Laryngoskope
 Fiber Optic Laryngoscopes
 Laringoscopios de luz fría
 Laringoscopi a fibra ottica

Kaltlicht
 Cold Light
 Luz fría
 Luce fredda



McINTOSH

05212-03

Set bestehend aus:

- 1 Etui
- 1 Batteriegriff 05238-03
- 3 Spatel (Fig. 2-4)
- 1 Ersatzlampe Xenon 05239-03

Set consisting of:

- 1 Case
- 1 Handle 05238-03
- 3 Blades (Fig. 2-4)
- 1 Spare Bulb Xenon 05239-03

Juego compuesto de:

- 1 Estuche
- 1 Mango 05238-03
- 3 Hojas (Fig. 2-4)
- 1 Bombilla de recambio Xenon 05239-03

Set composto da:

- 1 valigetta
- 1 impugnatura 05238-03
- 3 Lame (Fig. 2-4)
- 1 lampadina di ricambio Xenon 05239-03

05212-04

Set bestehend aus:

- 1 Etui
- 1 Batteriegriff 05238-03
- 4 Spatel (Fig. 1-4)
- 1 Ersatzlampe Xenon 05239-03

Set consisting of:

- 1 Case
- 1 Handle 05238-03
- 4 Blades (Fig. 1-4)
- 1 Spare Bulb Xenon 05239-03

Juego compuesto de:

- 1 Estuche
- 1 Mango 05238-03
- 4 Hojas (Fig. 1-4)
- 1 Bombilla de recambio Xenon 05239-03

Set composto da:

- 1 valigetta
- 1 impugnatura 05238-03
- 4 Lame (Fig. 1-4)
- 1 lampadina di ricambio Xenon 05239-03

Laryngoskopie-Spatel mit integriertem Kaltlichtträger
 Laryngoscope Blades with Integrated Cold Light Carrier
 Espátulas de laringoscopios con luz fría integrada
 Lame per laringoscopio con portatore di luce fredda integrato

Kaltlicht
 Cold Light
 Luz fría
 Luce fredda



McINTOSH



05211-00
 59 mm, 2.32"
 Nutzlänge
 working length
 largo útil

Fig. 0
 für Säuglinge
 for babies
 para neonatales



05211-01
 72 mm, 2.83"
 Nutzlänge
 working length
 largo útil

Fig. 1
 für Kinder
 for children
 para niños



05211-02
 92 mm, 3.62"
 Nutzlänge
 working length
 largo útil

Fig. 2
 für Jugendliche
 for adolescents
 para adolescentes



05211-03
 112 mm, 4.41"
 Nutzlänge
 working length
 largo útil

Fig. 3
 für Frauen
 for women
 para mujeres



05211-04
 136 mm, 5.35"
 Nutzlänge
 working length
 largo útil

Fig. 4
 für Männer
 for men
 para hombres

Kaltlicht Laryngoskope
Fiber Optic Laryngoscopes
Laringoscopios de luz fría
Laringoscopi a fibra ottica

Kaltlicht
Cold Light
Luz fría
Luce fredda

**MILLER****05213-03CL**

Set bestehend aus:

- 1 Etui
- 1 Batteriegriff 05238-03
- 3 Spatel (Fig. 1-3)
- 1 Ersatzlampe Xenon 05239-03

Set consisting of:

- 1 Case
- 1 Handle 05238-03
- 3 Blades (Fig. 1-3)
- 1 Spare Bulb Xenon 05239-03

Juego compuesto de:

- 1 Estuche
- 1 Mango 05238-03
- 3 Hojas (Fig. 1-3)
- 1 Bombilla de recambio Xenon 05239-03

Set composto da:

- 1 valigetta
- 1 impugnatura 05238-03
- 3 Lame (Fig. 1-3)
- 1 lampadina di ricambio Xenon 05239-03

05213-04CL

Set bestehend aus:

- 1 Etui
- 1 Batteriegriff 05238-03
- 4 Spatel (Fig. 1-4)
- 1 Ersatzlampe Xenon 05239-03

Set consisting of:

- 1 Case
- 1 Handle 05238-03
- 4 Blades (Fig. 1-4)
- 1 Spare Bulb Xenon 05239-03

Juego compuesto de:

- 1 Estuche
- 1 Mango 05238-03
- 4 Hojas (Fig. 1-4)
- 1 Bombilla de recambio Xenon 05239-03

Set composto da:

- 1 valigetta
- 1 impugnatura 05238-03
- 4 Lame (Fig. 1-4)
- 1 lampadina di ricambio Xenon 05239-03

Laryngoskopie-Spatel Mit Integriertem Kaltlichtträger
 Laryngoscope Blades With Integrated Cold Light Carrier
 Espátulas de Laringoscopios Con Luz Fría Integrada
 Lame Per Laringoscopio Con Portatore di Luce Fredda Integrato

Kaltlicht
 Cold Light
 Luz Fría
 Luce Fredda

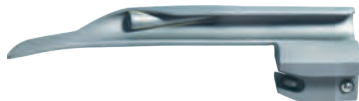


MILLER



05230-00CL
 55 mm, 2.16"
 Nutzlänge
 working length
 largo útil

Fig. 0
 für Säuglinge
 for babies
 para neonatales



05230-01CL
 80 mm, 3.15"
 Nutzlänge
 working length
 largo útil

Fig. 1
 für Kinder
 for children
 para niños



05230-02CL
 130 mm, 5.12"
 Nutzlänge
 working length
 largo útil

Fig. 2
 für Jugendliche
 for adolescents
 para adolescentes



05230-03CL
 170 mm, 6.69"
 Nutzlänge
 working length
 largo útil

Fig. 3
 für Frauen
 for women
 para mujeres



05230-04CL
 188 mm, 7.4"
 Nutzlänge
 working length
 largo útil

Fig. 4
 für Männer
 for men
 para hombres

Laryngoskope Warmlicht
Laryngoscopes Warm Light
Laringoscopios de Luz Caliente
Laringoscopi a Luce Calda

Warmlicht
Warm Light
Luz Caliente
Luce Calda



McINTOSH

05203-00

Set bestehend aus:

- 1 Etui
- 1 Batteriegriff 05234-28
- 3 Spatel (Fig. 2-4)
- 2 Ersatzlampen 05239-02

Set consisting of:

- 1 Case
- 1 Handle 05234-28
- 3 Blades (Fig. 2-4)
- 2 Spare Bulbs 05239-02

Juego compuesto de:

- 1 Estuche
- 1 Mango 05234-28
- 3 Hojas (Fig. 2-4)
- 2 Bombilla de recambio 05239-02

Set composto da:

- 1 valigetta
- 1 impugnatura 05234-28
- 3 Lame (Fig. 2-4)
- 2 Lampadine di ricambio 05239-02

05204-00

Set bestehend aus:

- 1 Etui
- 1 Batteriegriff 05234-28
- 4 Spatel (Fig. 1-4)
- 2 Ersatzlampen 05239-02

Set consisting of:

- 1 Case
- 1 Handle 05234-28
- 4 Blades (Fig. 1-4)
- 2 Spare Bulbs 05239-02

Juego compuesto de:

- 1 Estuche
- 1 Mango 05234-28
- 4 Hojas (Fig. 1-4)
- 1 Bombilla de recambio 05239-02

Set composto da:

- 1 valigetta
- 1 impugnatura 05234-28
- 4 Lame (Fig. 1-4)
- 2 Lampadine di ricambio 05239-02

Laryngoskopie-Spatel Mit Integriertem Warmlichtträger
 Laryngoscope Blades With Integrated Warm Light Carrier
 Espátulas de Laringoscopios Con Luz Caliente Integrada
 Lame Per Laringoscopio Con Portatore di Luce Calda Integrato

Warmlicht
 Warm Light
 Luz Caliente
 Luce Calda



McINTOSH



05210-00
 59 mm, 2.32"
 Nutzlänge
 working length
 largo útil
 lunghezza utile

Fig. 0
 für Säuglinge
 for babies
 para neonatales
 per neonati



05210-01
 72 mm, 2.83"
 Nutzlänge
 working length
 largo útil
 lunghezza utile

Fig. 1
 für Kinder
 for children
 para niños
 per bambini



05210-02
 92 mm, 3.62"
 Nutzlänge
 working length
 largo útil
 lunghezza utile

Fig. 2
 für Jugendliche
 for adolescents
 para adolescentes
 per adolescenti



05210-03
 112 mm, 4.41"
 Nutzlänge
 working length
 largo útil
 lunghezza utile

Fig. 3
 für Frauen
 for women
 para mujeres
 per donne



05210-04
 136 mm, 5.35"
 Nutzlänge
 working length
 largo útil
 lunghezza utile

Fig. 4
 für Männer
 for men
 para hombres
 per uomini

Laryngoskope Warmlicht
Laryngoscopes Warm Light
Laringoscopios de Luz Caliente
Laringoscopi a Luce Calda

Warmlicht
Warm Light
Luz Caliente
Luce Calda

**MILLER**

05213-03

Set bestehend aus:

- 1 Etui
- 1 Batteriegriff 05234-28
- 3 Spatel (Fig. 1-3)
- 1 Ersatzlampe 05239-01
- 1 Ersatzlampe 05239-02

Set consisting of:

- 1 Case
- 1 Handle 05234-28
- 3 Blades (Fig. 1-3)
- 1 Spare Bulb 05239-01
- 1 Spare Bulb 05239-02

Juego compuesto de:

- 1 Estuche
- 1 Mango 05234-28
- 3 Hojas (Fig. 1-3)
- 1 Bombilla de recambio 05239-01
- 1 Bombilla de recambio 05239-02

Set composto da:

- 1 valigetta
- 1 impugnatura 05234-28
- 3 Lame (Fig. 1-3)
- 1 lampadina di ricambio 05239-01
- 1 lampadina di ricambio 05239-02

05213-04

Set bestehend aus:

- 1 Etui
- 1 Batteriegriff 05234-28
- 4 Spatel (Fig. 1-4)
- 1 Ersatzlampe 05239-01
- 1 Ersatzlampe 05239-02

Set consisting of:

- 1 Case
- 1 Handle 05234-28
- 4 Blades (Fig. 1-4)
- 1 Spare Bulb 05239-01
- 1 Spare Bulb 05239-02

Juego compuesto de:

- 1 Estuche
- 1 Mango 05234-28
- 4 Hojas (Fig. 1-4)
- 1 Bombilla de recambio 05239-01
- 1 Bombilla de recambio 05239-02

Set composto da:

- 1 valigetta
- 1 impugnatura 05234-28
- 4 Lame (Fig. 1-4)
- 1 lampadina di ricambio 05239-01
- 1 lampadina di ricambio 05239-02

Laryngoskope Warmlicht
 Laryngoscopes Warm Light
 Laringoscopios de Luz Caliente
 Laringoscopi a Luce Calda

Warmlicht
 Warm Light
 Luz Caliente
 Luce Calda



MILLER



05230-00
 55 mm, 2 1/2"
 Nutzlänge
 working length
 largo útil
 lunghezza utile

für Säuglinge
 for babies
 para neonatales
 per neonati



05230-01
 80 mm, 3 1/8"
 Nutzlänge
 working length
 largo útil
 lunghezza utile

für Kinder
 for children
 para niños
 per bambini



05230-02
 130 mm, 5"
 Nutzlänge
 working length
 largo útil
 lunghezza utile

für Jugendliche
 for adolescents
 para adolescentes
 per adolescenti



05230-03
 170 mm, 6 3/4"
 Nutzlänge
 working length
 largo útil
 lunghezza utile

für Frauen
 for women
 para mujeres
 per donne



05230-04
 180 mm, 7"
 Nutzlänge
 working length
 largo útil
 lunghezza utile

für Männer
 for men
 para hombres
 per uomini

Batteriegriffe, Warmlicht
Battery Handles, Warm Light
Mango de Pila, Luz Caliente
Manico a Batteria, Luce Calda

Warmlicht
Warm Light
Luz Caliente
Luce Calda



Klein
Small
Pequeño
Piccolo



05233-18
14 cm
19 cm Ø

mittel
medium
medio
medio



05234-28
14,5 cm
29 cm Ø



05239-01 2,5 V
Fig. 0-1



05239-02 2,5 V
Fig. 2-4

Ersatzlampe
Spare Bulb
Bombilla de recambio
Lampadina di riserva

Batteriegriffe, Kaltlicht
 Battery Handles, Cold Light
 Mango de Pila, Luz Fria
 Manico a Batteria Per Luce Fredda

Kaltlicht
 Cold Light
 Luz Fria
 Luce Fredda



Klein
 Small
 Pequeño
 Piccolo



15,5 cm
 Ø 19 mm

05238-02

05238-12

mittel
 medium
 medio
 medio



15,5 cm
 Ø 28 mm

05238-03

05238-13



05239-03 Xenon 2,5 V

Ersatzlampe
 Spare Bulb
 Bombilla de recambio
 Lampadina di ricambio

mit Xenon-Lampe
 with Xenon-Lamp
 con lampara Xenon
 con lampada Xenon

mit LED-Lampe
 with LED-Lamp
 con lampara LED
 mit LED-Leuchte

Batteriegriffe, Kaltlicht
Battery Handles, Cold Light
Mango de Pila, Luz Fría
Manico a Batteria, Luce Fredda

Kaltlicht
Cold Light
Luz Fría
Luce Fredda



mit Adapter für mittlere und kleine Griffe
with adaptor for medium and small handles
con adaptador para mangos medianos y pequeños
con adattatore per manici medi e piccoli

**05241-11**

Ladestation für 1 aufladbare Laryngoskop-Griffe
(2.5V and 3.5V) mit Adapter zu Mittel und Klein Griffe,
90-240V, mit universalem Netzstecker

Charger for 1 rechangable laryngoscope handles
(2.5V and 3.5V) suitable for medium and small handles,
90-240V, with universal country power adapter

Cargador para 1 mango de laringoscopio
recambiable (2.5V and 3.5V) apto para mangos
medianos y pequeños, 90-240V, con adaptador de
corriente universal del país

Caricabatterie per 1 impugnature intercambiabili del
laringoscopio adatto (2.5V and 3.5V) per impugnature
medie e piccole, 90-240V, con adattatore di
alimentazione universale per il paese

05241-12

Ladestation für 2 aufladbare Laryngoskop-Griffe
(2.5V and 3.5V) mit Adapter zu Mittel und Klein Griffe,
90-240V, mit universalem Netzstecker

Charger for 2 rechangable laryngoscope handles
(2.5V and 3.5V) suitable for medium and small handles,
90-240V, with universal country power adapter

Cargador para 2 mango de laringoscopio
recambiable (2.5V and 3.5V) apto para mangos
medianos y pequeños, 90-240V, con adaptador de
corriente universal del país

Caricabatterie per 2 impugnature intercambiabili del
laringoscopio adatto (2.5V and 3.5V) per impugnature
medie e piccole, 90-240V, con adattatore di
alimentazione universale per il paese

Batteriegriffe, Kaltlicht
 Battery Handles, Cold Light
 Mango de Pila, Luz Fría
 Manico a Batteria, Luce Fredda

Grünsystem, Edelstahl Griffe, mit hochleistungs LED Lampe, 3,5 V
 Green system, Stainless Steel Handles, with high powered LED lamp, 3.5 V
 Sistema verde, asas de acero inoxidable, con lámpara LED de alta potencia, 3,5 V
 Sistema verde, maniglie in acciaio inossidabile, con lampada LED ad alta potenza, 3,5 V

Aufladbar, komplett mit Akku
 Rechargeable, complete with battery
 Recargable, con batería
 Ricaricabile, completo di batteria

mittel
 medium
 medio
 medio



05239-30

klein
 small
 pequeño
 piccolo



05239-19

Li-ion Akku zu Laryngoskop-Griff, Aufladbar
 Li-ion Rechargeable Battery alone, for laryngoscope handles
 Batería recargable de iones de litio sola, para mangos de laringoscopia
 Batteria ricaricabile agli ioni di litio da sola, per le impugnature del laringoscopia

für mittlere Griffe
 for medium handle
 para la manivela mediana
 per manico medio



05244-01

für kleine Griffe
 for small Handle
 para la manija pequeña
 per la piccola maniglia



05244-02

Laryngoskope
Laryngoscopes
Laringoscopios
Laringoscopi

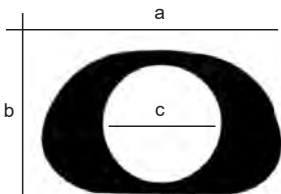
Operation Laryngoskop:
rostfreier Edelstahl
Rohr: innen matt/außen glänzend
Griff: ganz matt

Operation Laryngoscope:
stainless steel
tube: inner surface matt/outer
surface polished
handle: matt

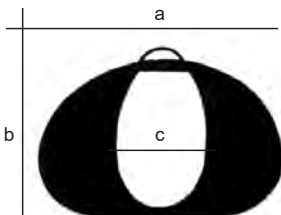


Laringoscopio para operaciones:
Acero inoxidable
Pala: Superficie interior: Mate
Superficie exterior: Brillante
Mango entero: Mate

Laringoscopio a luce
fredda per microchirurgia
endolaringeo
tubo: interiore opaco – esterno lucido
manico: opaco



Nr.	L (mm)	a (mm)	b (mm)	c (mm)	Lichtträger light guide Portador de luz portatore di luce
05301-01	135	21,8	14,0	13,0	05302-01
05301-02	152	22,5	14,8	13,0	05302-01
05301-03	182	23,0	15,0	14,0	05302-02
05301-04	172	29,5	18,0	17,0	05302-02
05301-05	172	31,5	21,5	19,0	05302-02



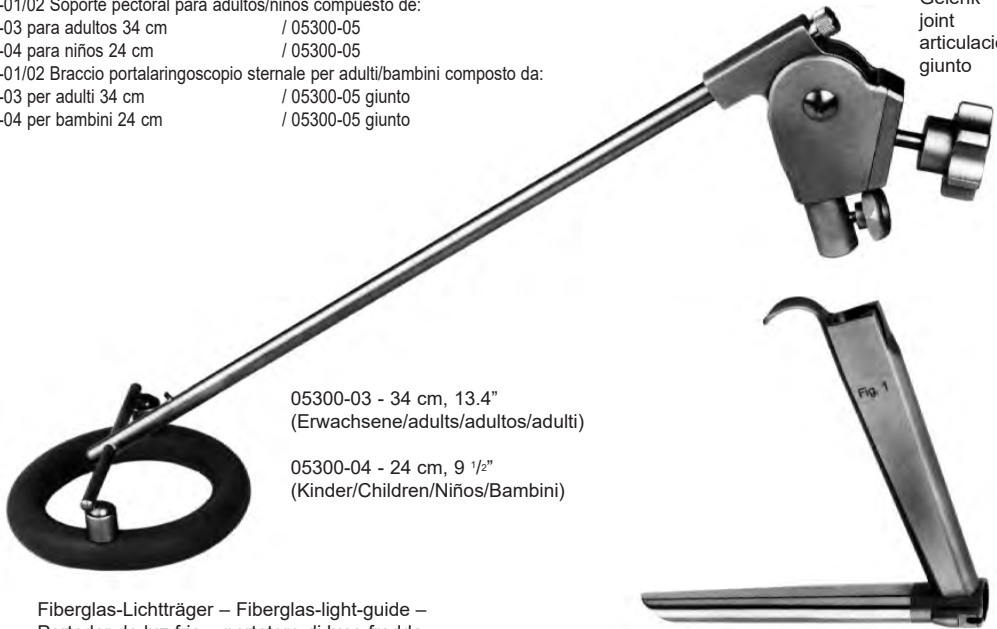
Nr.	L (mm)	a (mm)	b (mm)	c (mm)	Lichtträger light guide Portador de luz portatore di luce
05301-06	182	29,0	20,0	16,0 x 26,0	05302-02
05301-07	222	29,0	20,0	16,0 x 26,0	05302-03

Laryngoskope
Laryngoscopes
Laringoscopios
Laringoscopi

05300-01/02 Bruststütze für Erwachsene/Kinder bestehend aus:
05300-03 Stützstange für Erwachsene 34 cm / 05300-05 Gelenk
05300-04 Stützstange für Kinder 24 cm / 05300-05 Gelenk
05300-01/02 Chest Support for adults/children complete consisting of:
05300-03 Support rod for adults 34 cm / 05300-05 Joint
05300-04 Support rod for children 24 cm / 05300-05 Joint
05300-01/02 Soporte pectoral para adultos/niños compuesto de:
05300-03 para adultos 34 cm / 05300-05
05300-04 para niños 24 cm / 05300-05
05300-01/02 Braccio portalarinoscopio sternale per adulti/bambini composto da:
05300-03 per adulti 34 cm / 05300-05 giunto
05300-04 per bambini 24 cm / 05300-05 giunto

Operationslaryngoskop, Kleinsasser
Operation laryngoscope, Kleinsasser
Laringoscopios operativo, Kleinsasser
Laringoscopio operativo, Kleinsasser

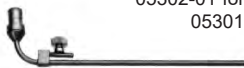
05300-05
Gelenk
joint
articulacion
giunto



05300-03 - 34 cm, 13.4"
(Erwachsene/adults/adultos/adulti)

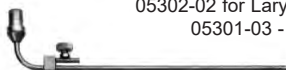
05300-04 - 24 cm, 9 1/2"
(Kinder/Children/Niños/Bambini)

Fiberglas-Lichtträger – Fiberglas-light-guide –
Portador de luz fria – portatore di luce fredda
a fibre di vetro



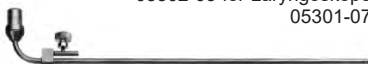
05302-01 for Laryngoskope
05301-01 - 05301-02

05303-01
Injektionskanüle für Laryngoskope: 05301-01 - 05301-07
Injetion drain tube for Laryngoscopes: 05301-01 - 05301-07
Canúla de inyeccion para laringoscopios: 05301-01 - 05301-07
Cannula da iniezione per laringoscopi: 05301-01 - 05301-07



05302-02 for Laryngoskope
05301-03 - 05301-06

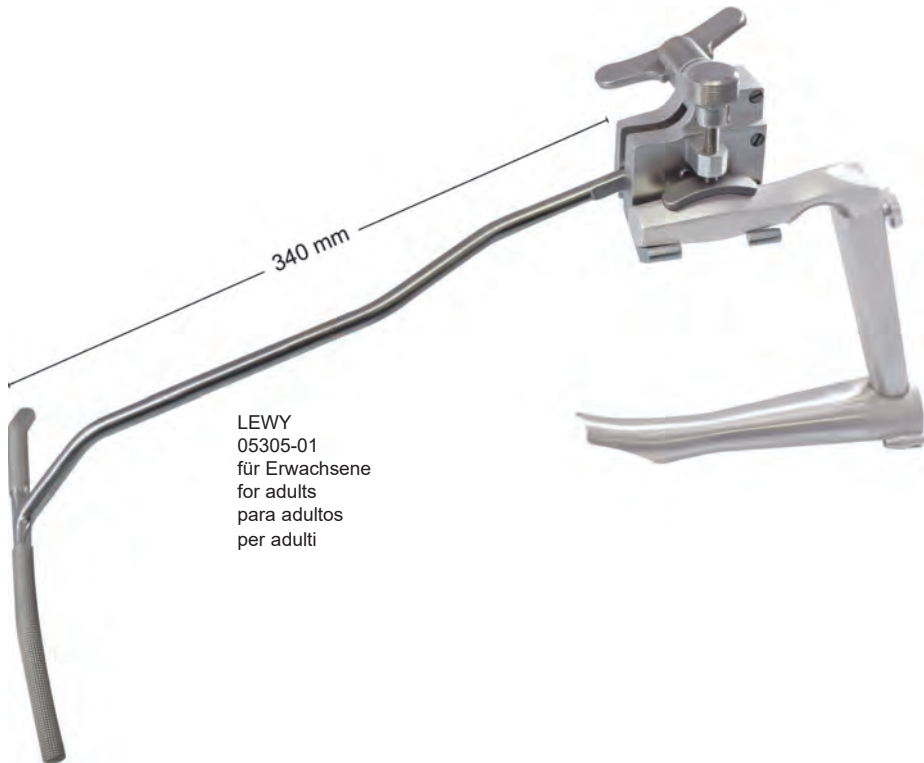
05304-01
Rauchabsaugrohr für Laryngoskop:
Suction tube for Laryngoscopes:
Canúla de succion para laringoscopios:
Tubo di aspirazione per laringoscopi:



05302-03 for Laryngoskope
05301-07



Bruststütze, für Operations-Laryngoskop
 Chest Support, for Operation Laryngoscope
 Soporte pectoral para laringoscopios operativo
 Supporto toracico per laringoscopi operativi



LEWY
 05305-01
 für Erwachsene
 for adults
 para adultos
 per adulti

05305-02
 Laryngoskope-Handgriff, abnehmbar
 Laryngoscope Handle, detachable
 Mango para laringoscopios, desmontable
 Manico per laringoscopia, staccabile

Verwendung mit
 use with
 utilizar con
 utilizzare con



05305-01
 LEWY Bruststütze für Operations-Laryngoskope
 LEWY Chest Support for Operating Laryngoscope
 Soporte pectoral LEWY para laringoscopios operativo
 Supporto toracico LEWY per laringoscopia operativo

Skalpell-Griffe
 Scalpel Handles
 Mangos de bisturíes
 Manici per lama bisturi

passend zu den Klängen
 for blades
 para las hojas
 per lama bisturi

Ⓐ No. 10, 11, 12, 13, 14, 15, 16, 17, 18, 19

Ⓑ No. 20, 21, 22, 23, 24, 25



BARRON
 07102-00

Ⓐ



07103-00
 Fig. 3

Ⓐ



07103-01
 Fig. 3 grad.

Ⓐ



07103-02
 Fig. 3 L

Ⓐ

Skalpelli-Griffe
Scalpel Handles
Mangos de bisturíes
Manici per lama bisturi



07104-00
Fig. 4

Ⓑ



07104-02
Fig. 4 L

Ⓑ



07105-02
Fig. 4 L

Ⓑ

Skalpell-Griffe
Scalpel Handles
Mangos de bisturíes
Manici per lama bisturi



07106-01
14,5 cm, 5 3/4"

Ⓐ



07106-02
14 cm, 5 1/2"

Ⓐ

Skalpelli-Griffe
Scalpel Handles
Mangos de bisturíes
Manici per lama bisturi



07107-00
16,5 cm, 6 1/2"
Fig. 7

Ⓐ



07107-01
12 cm, 4 3/4"
Fig. 7K

Ⓐ



07107-03
22,5 cm, 8.9"

Ⓐ



07107-04
22,5 cm, 8.9"

Ⓐ

Skalpell-Griffe
Scalpel Handles
Mangos de bisturíes
Manici per lama bisturi



07108-00
Fig. 8

Ⓐ



07109-03
Fig. 3 L

Ⓐ

Skalpelli-Griffe
Scalpel Handles
Mangos de bisturíes
Manici per lama bisturi



07109-10 10,0 cm, 4"
07109-13 13,0 cm, 5"
07109-15 15,5 cm, 6"

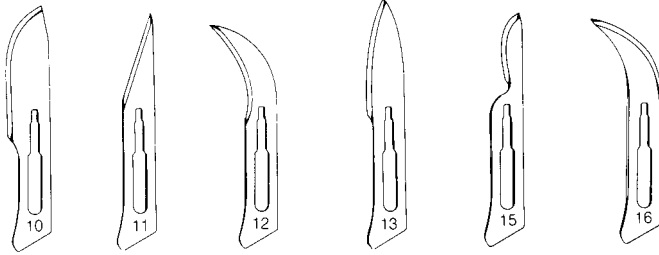


07161-00 07162-00 07165-00 07167-00

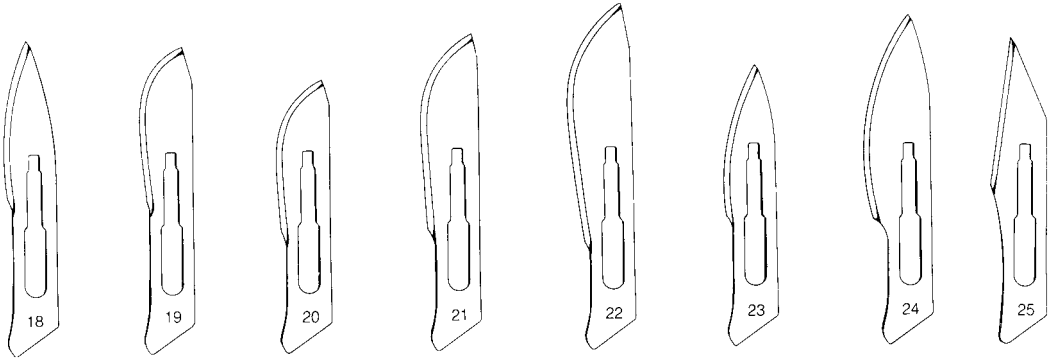
Packung mit 10 Stück
box of 10
en cajas de 10 pzas
confezione di 10



Skalpelli-Klingen, Steril
 Scalpel Blades, Sterile
 Hojas de bisturí, estéril
 Lame per bisturi, sterili



07110-00 07111-00 07112-00 07113-00 07115-00 07116-00



07118-00 07119-00 07120-00 07121-00 07122-00 07123-00 07124-00 07125-00



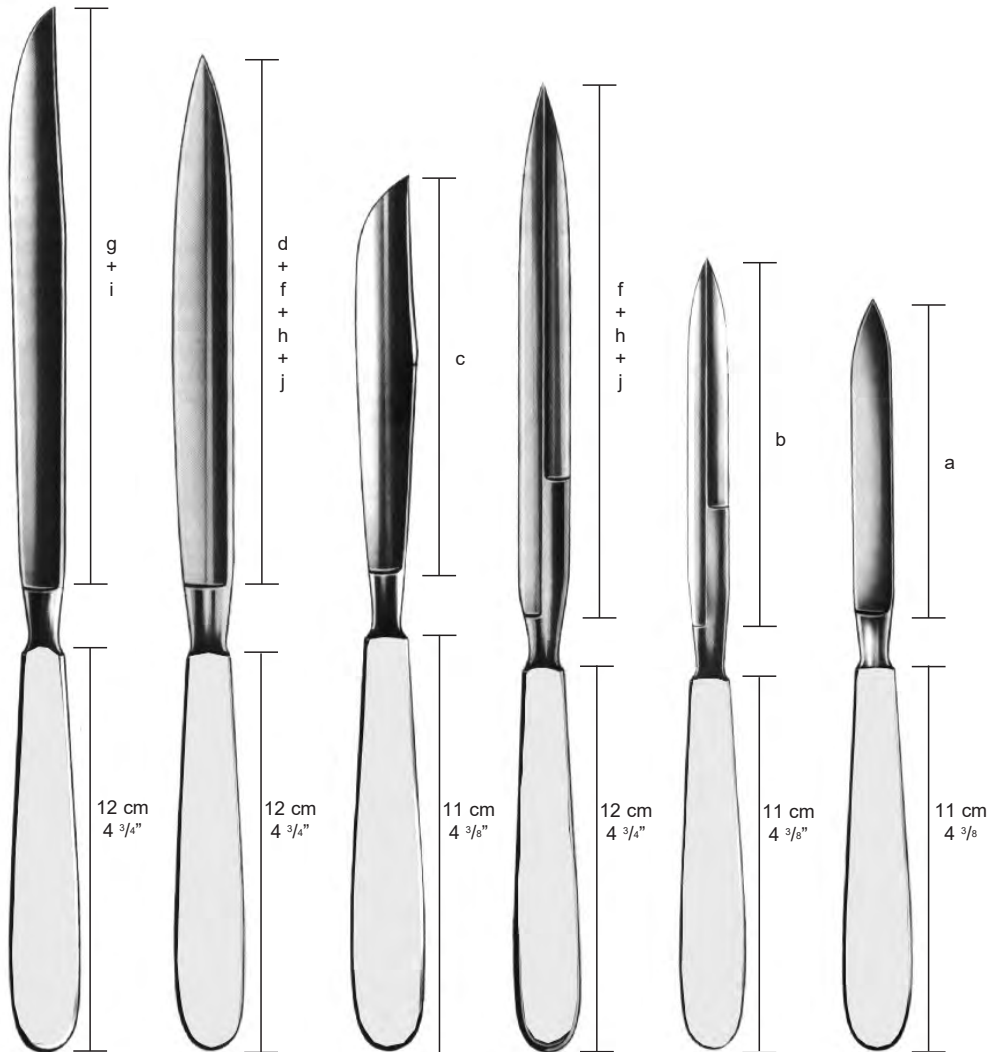
Packung mit 100 Stück
 in packages of 100 each
 en cajas de 100 c/u
 confezione di 100 pezzi

Skalpellklingen-Entferner
 Scalpel Blade Remover
 Quita hojas
 Togililama



07130-00

Amputationsmesser
Amputation Knives
Cuchillos para amputación
Coltelli per amputazione



LISTON
07200-17
07200-20

REDA
07201-13
07201-16
07201-19
07201-22

LANGEN-
BECK
07202-12

CATLIN
doppelschneidig
double cutting
filo doble
doppio taglio
07203-16
07203-19
07203-22

07204-11
Zwischenknochen-
messer doppel-
schneidig
Inerosseous knife
double cutting
Cuchillo interóseo
filo doble
Coltello interosseo
doppio taglio

07205-09
Phalangen-
messer
Phalangeal knife
Cuchillos para
falanges
Coltello per falangi

Schnittlänge
Length of blades
Largo de hojas
Lunghezza delle lame

a - 9,5 cm	c - 12,0 cm	g - 17,0 cm	i - 20,0 cm
b - 11,0 cm	d - 13,0 cm	f - 16,0 cm	h - 19,0 cm
a - 3 3/4"	c - 4 3/4"	g - 6 3/4"	i - 8"
b - 4 3/8"	d - 5"	f - 6 1/4"	h - 7 1/2"
			j - 8 3/4"

Klingenbrecher, Rasierklingen
Blade Breakers, Razor Blades
Rompe-hojas, hojas de afeitar
Lama di rasoio, Rompilamette



TROUTMAN-CHRIS
07290-09 9 cm, 3 1/2"



REDA
07291-11 11 cm, 4 3/8"



CASTROVIEJO
07294-13 13 cm, 5 1/8"



07296-00

Packung = 10 Stück
package = 10 each
caja = 10 c/u
confezione = 10 pezzi

Skalpelle mit Metallheft
 Scalpels with Metal Handle
 Bisturíes, mango metálico
 Bisturi, manico di metallo



Fig. 1
07402-01
15 cm, 6"
30 mm, 1.2"

Fig. 2
07402-02
15 cm, 6"
36 mm, 1.4"

Fig. 3
07402-03
15,5 cm, 6"
40 mm, 1 1/2"

Fig. 4
07402-04
16 cm, 6 1/4"
45 mm, 1 3/4"

Fig. 5
07402-05
16 cm, 6 1/4"
50 mm, 2"



Fig. 6
07402-06
15 cm, 6"
27 mm, 1"

Fig. 7
07402-07
15 cm, 6"
35 mm, 1.4"

Fig. 8
07402-08
16 cm, 6 1/4"
40 mm, 1 1/2"

Fig. 9
07402-09
16 cm, 6 1/4"
47 mm, 1.9"

Fig. 10
07402-10
17 cm, 6 3/4"
50 mm, 2"

Resektions- und Knorpelmesser
 Resection and Cartilage Knives
 Cuchillos para resección/cartilagos
 Coltelli per resezione e cartilagini



6,5 cm
2.6"

Beinhautmesser
 mit Schaber
 Periosteum Knife
 with raspator
 Cuchillo para
 periostio, con
 periostótamo
 Coltello per
 periostio con
 raschino

19 cm, 7 1/2"

07403-01

Metallheft
 metal handle
 mango metálico
 manico di metallo



6,5 cm
2.6"

19 cm, 7 1/2"

07403-02

Holzheft
 wooden handle
 mango de madera
 manico in legno



5,5 cm
2.2"

18 cm, 7"

LANGENBECK
07410-05



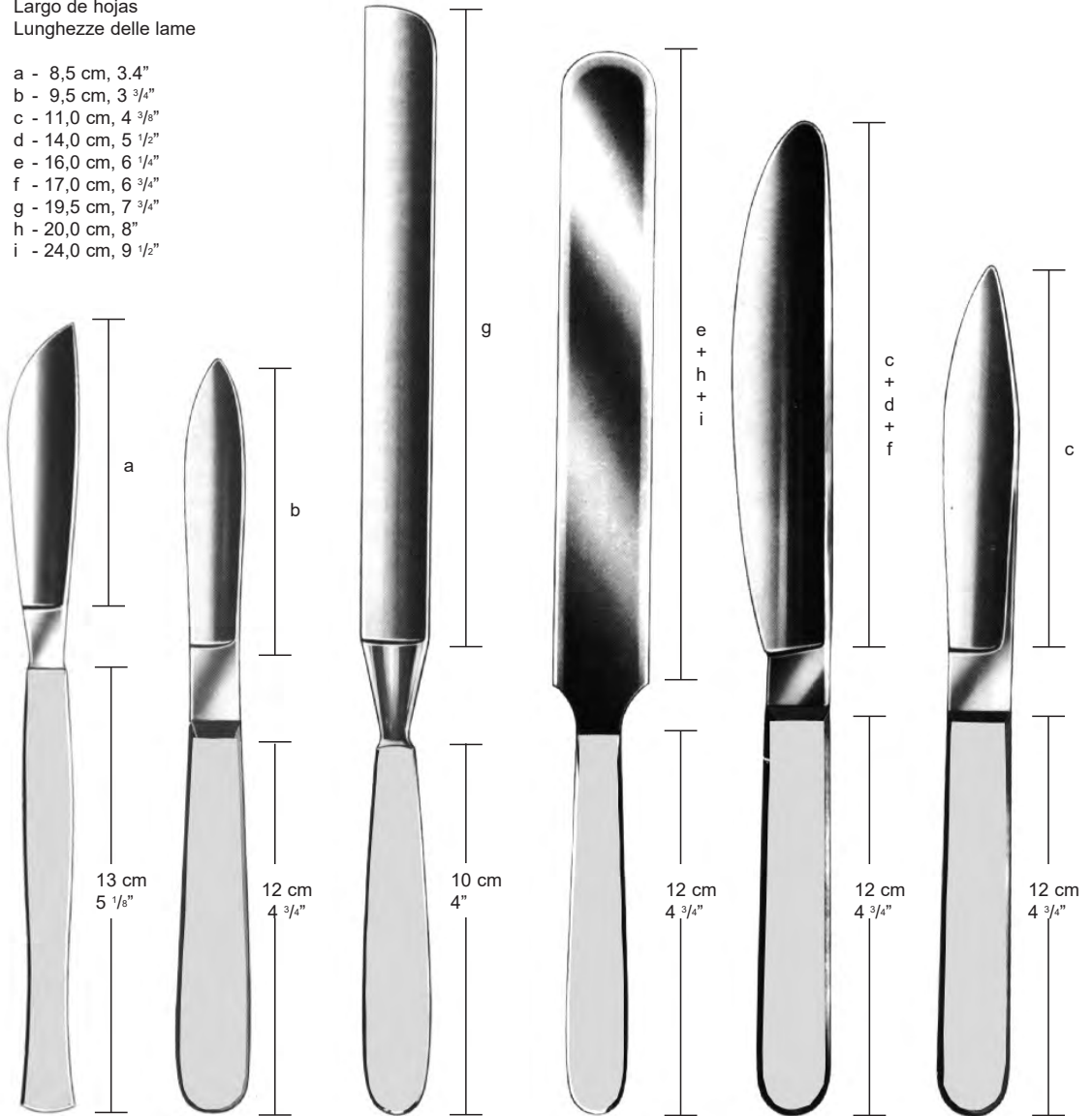
18 cm, 7"

LANGENBECK
07412-05

Sezier-, Hirn- und Organmesser
Autopsy- Brain- and Post mortem knives
Cuchillos para autopsia- cerebro- órganos
Coltelli per cartilagini- cervello e organi

Schnittlänge
Length of blades
Largo de hojas
Lunghezze delle lame

- a - 8,5 cm, 3,4"
- b - 9,5 cm, 3 3/4"
- c - 11,0 cm, 4 3/8"
- d - 14,0 cm, 5 1/2"
- e - 16,0 cm, 6 1/4"
- f - 17,0 cm, 6 3/4"
- g - 19,5 cm, 7 3/4"
- h - 20,0 cm, 8"
- i - 24,0 cm, 9 1/2"



VIRCHOW
07420-08

VIRCHOW
07421-09

07422-19

VIRCHOW
07423-16
07423-20
07423-24

07424-11
07424-14
07424-17

07425-11

Dermatome, Rasiermesser
 Dermatome, Razor
 Dermátomo, Navajas
 Dermatomo, Rasoio

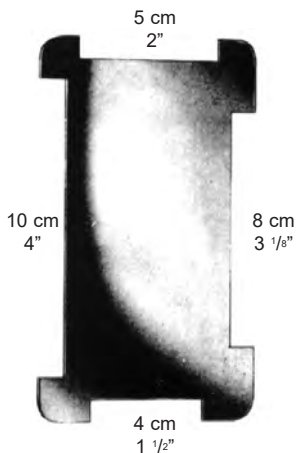


SCHINK
 07490-00
 30 cm, 11 3/4"
 0,1 - 2 mm
 compl.
 mit/with/con
 07490-01 (1) Stk./ pcs / pzas
 07490-02 (2) Stk./ pcs / pzas



07490-01
 10 cm, 4"

Ersatzklinge
 Spare blade
 Hoja de repuesto
 Lama di ricambio per dermatomo



07490-02

Spannplatte
 Skin straightening plate
 Placa para extender la piel
 Placca per stendipelle

Dermatome
 Dermatome
 Dermátomo
 Dermatomo



07496-31
 Ersatzklingen Spa-
 re blades
 Hoja de repuesto
 Lama di ricambio



07296-00
 Ersatzklingen
 Spare blades
 Hoja de repuesto
 Lama di ricambio



07499-01
 Ersatzklingen
 Spare blades
 Hoja de repuesto
 Lama di ricambio

HUMBY
 07495-31 31 cm, 12 1/4"
 0,1 - 1,5 mm
 mit 1 Klinge
 with 1 blade
 con 1 hoja
 con 1 lama

SILVER
 07498-00 19 cm, 7 1/2"
 mit 1 Klinge
 with 1 blade
 con 1 hoja
 con 1 lama

WATSON
 07499-00 30 cm, 11 3/4"
 0,1 - 1,5 mm
 mit 1 Klinge
 with 1 blade
 con 1 hoja
 con 1 lama

Chirurgische Scheren
Operating Scissors
Tijeras para cirugía
Forbici per chirurgia



STANDARD

09102-11	11,5 cm, 4½"
09102-13	13,0 cm, 5"
09102-14	14,5 cm, 5¾"
09104-14 TC	
09102-15	15,5 cm, 6"
09102-16	16,5 cm, 6½"
09102-18	18,5 cm, 7¼"
09102-20	20,0 cm, 8"



STANDARD

09110-11	11,5 cm, 4½"
09110-13	13,0 cm, 5"
09110-14	14,5 cm, 5¾"
09114-14 TC	
09110-15	15,5 cm, 6"
09110-16	16,5 cm, 6½"
09110-18	18,5 cm, 7¼"
09110-20	20,0 cm, 8"



STANDARD

09120-11	11,5 cm, 4½"
09120-13	13,0 cm, 5"
09120-14	14,5 cm, 5¾"
09124-14 TC	
09120-15	15,5 cm, 6"
09120-16	16,5 cm, 6½"
09120-18	18,5 cm, 7¼"
09120-20	20,0 cm, 8"



STANDARD

09103-11	11,5 cm, 4½"
09103-13	13,0 cm, 5"
09103-14	14,5 cm, 5¾"
09105-14 TC	
09103-15	15,5 cm, 6"
09103-16	16,5 cm, 6½"
09103-18	18,5 cm, 7¼"
09103-20	20,0 cm, 8"



STANDARD

09111-11	11,5 cm, 4½"
09111-13	13,0 cm, 5"
09111-14	14,5 cm, 5¾"
09115-14 TC	
09111-15	15,5 cm, 6"
09111-16	16,5 cm, 6½"
09111-18	18,5 cm, 7¼"
09111-20	20,0 cm, 8"



STANDARD

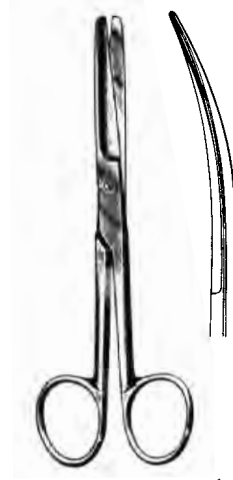
09121-11	11,5 cm, 4½"
09121-13	13,0 cm, 5"
09121-14	14,5 cm, 5¾"
09125-14 TC	
09121-15	15,5 cm, 6"
09121-16	16,5 cm, 6½"
09121-18	18,5 cm, 7¼"
09121-20	20,0 cm, 8"

Chirurgische Scheren
 Operating Scissors
 Tijeras para cirugía
 Forbici per chirurgia



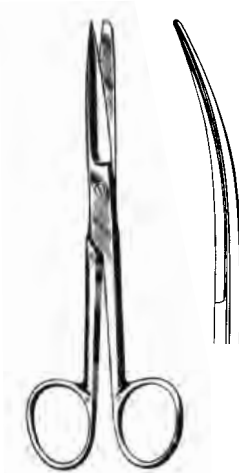
Inzisionsschere
 Incision Scissors
 Tijera de incision
 Forbici per incisione

09128-14
 14 cm, 5½"



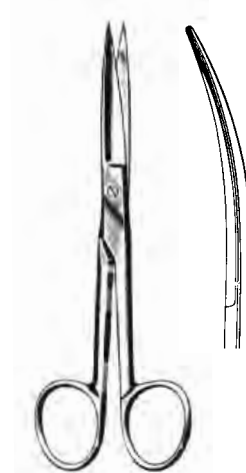
DEAVER

09130-14 14 cm, 5½" 09131-14



DEAVER

09140-14 14 cm, 5½" 09141-14



DEAVER

09150-14 14 cm, 5½" 09151-14

Präparierscheren
Dissecting Scissors
Tijeras de disección
Forbici per dissezione



MAYO

09160-14	14,5 cm, 5¾"	09161-14
09164-14 TC	14,5 cm, 5¾"	09165-14 TC
09160-15	15 cm, 6"	09161-15
09160-17	17,0 cm, 6¾"	09161-17
09164-17 TC	17,0 cm, 6¾"	09165-17 TC
09160-19	19,0 cm, 7½"	09161-19
09160-23	23,0 cm, 9"	09161-23
09164-23 TC	23,0 cm, 9"	09165-23 TC
09160-28	28,0 cm, 11"	09161-28



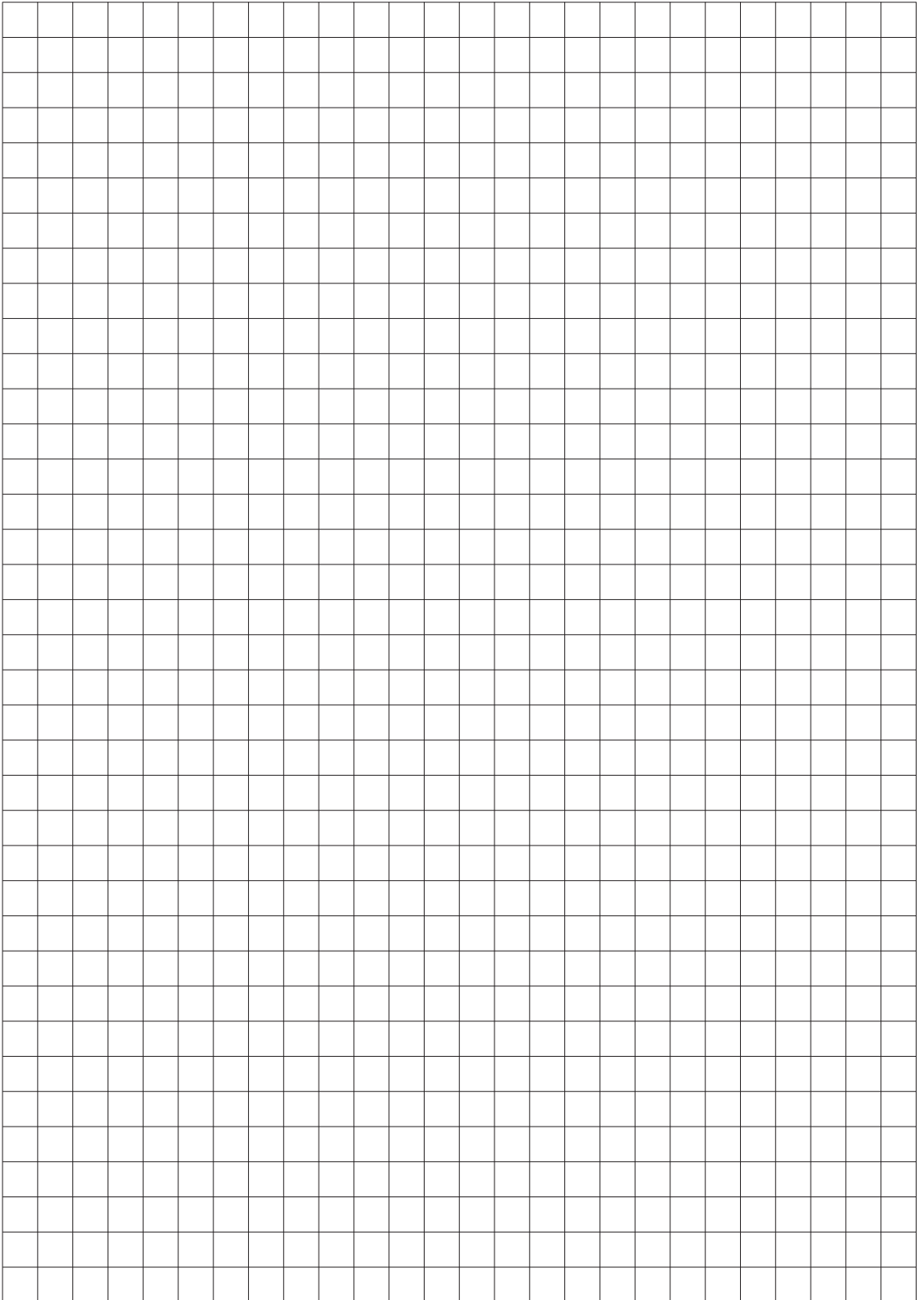
MAYO-STILLE

09170-15	15,0 cm, 6"	09171-15
09174-15 TC	15,0 cm, 6"	09175-15 TC
09170-17	17,0 cm, 6¾"	09171-17
09174-17 TC	17,0 cm, 6¾"	09175-17 TC
09170-21	21,0 cm, 8¼"	09171-21
09174-21 TC	21,0 cm, 8¼"	09175-21 TC

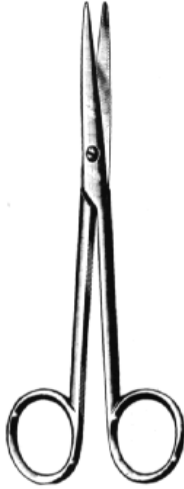


MAYO-NOBLE

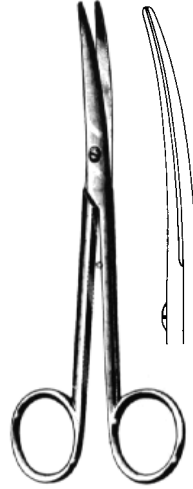
09180-17	17,0 cm, 6¾"	09181-17
----------	--------------	----------



Präparierscheren
Dissecting Scissors
Tijeras de disección
Forbici per dissezione



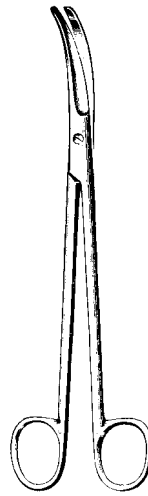
LEXER
09190-16
09194-16 TC
16 cm, 6¼"



LEXER
09191-16
09195-16 TC
16 cm, 6¼"



LEXER BABY
09202-10 09203-10
09206-10 TC 09207-10 TC
10 cm, 4"



JORGENSEN
09204-22
22 cm, 8¾"

Präparierscheren
Dissecting Scissors
Tijeras de disección
Forbici per dissezione



METZENBAUM
09280-12 **09284-12 TC**
12 cm, 4¾"
09280-15 **09284-15 TC**
15 cm, 6"
09280-18 **09284-18 TC**
18 cm, 7"
09280-20 **09284-20 TC**
20 cm, 8"
09280-23 **09284-23 TC**
23 cm, 9"
09280-25 **09284-25 TC**
25 cm, 10"
09280-28 **09284-28 TC**
28 cm, 11"
09280-30 **09284-30 TC**
30 cm, 12"



METZENBAUM
09281-12 **09285-12 TC**
12 cm, 4¾"
09281-15 **09285-15 TC**
15 cm, 6"
09281-18 **09285-18 TC**
18 cm, 7"
09281-20 **09285-20 TC**
20 cm, 8"
09281-23 **09285-23 TC**
23 cm, 9"
09281-25 **09285-25 TC**
25 cm, 10"
09281-28 **09285-28 TC**
28 cm, 11"
09281-30 **09285-30 TC**
30 cm, 12"



METZENBAUM FINO
09282-15 **09286-15 TC**
15 cm, 6"
09282-18 **09286-18 TC**
18 cm, 7"
09282-20 **09286-20 TC**
20 cm, 8"
09282-23 **09286-23 TC**
23 cm, 9"
09282-25 **09286-25 TC**
25 cm, 10"
09282-28 **09286-28 TC**
28 cm, 11"



METZENBAUM FINO
09283-15 **09287-15 TC**
15 cm, 6"
09283-18 **09287-18 TC**
18 cm, 7"
09283-20 **09287-20 TC**
20 cm, 8"
09283-23 **09287-23 TC**
23 cm, 9"
09283-25 **09287-25 TC**
25 cm, 10"
09283-28 **09287-28 TC**
28 cm, 11"

Präparierschere, Kapselschere
Dissecting Scissors, Capsula Scissors
Tijeras de disección, Tijera p. cápsula
Forbici per dissezione, Forbici per capsula



WELLER
09289-28
28 cm, 11"



RESANO
09290-25
25 cm, 10"

Präparierscheren
Dissecting Scissors
Tijeras de disección
Forbici per dissezione

NOIR



METZENBAUM



09281-15B
14,5 cm, 5¾"



09281-18B
18 cm, 7"

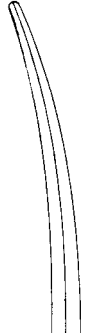


09281-20B
20 cm, 8"



09283-18B
18 cm, 7"

fein
delicate
fina
delicate



09283-20B
20 cm, 8"

fein
delicate
fina
delicate

Präparierscheren
Dissecting Scissors
Tijeras de disección
Forbici per dissezione

NOIR

Wellenschliff
Wave cut
Corte de onda
Taglio a onda

**METZENBAUM**

09285-15W
14,5 cm, 5¾"



09285-18W
18 cm, 7"



09285-20W
20 cm, 8"

Präparierscheren, Ligaturscheren
 Dissecting Scissors, Ligature Scissors
 Tijeras de disección, Tijeras para ligaduras
 Forbici per dissezione, Forbici per legature



METZENBAUM "S"

09291-18 18 cm, 7" 09295-18 TC
 09291-20 18 cm, 7" 09295-20 TC
 09291-23 23 cm, 9" 09295-23 TC

Wellenschliff - wave cut



09296-15 TC
 14,5 cm, 5¾"

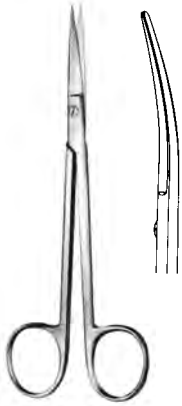


09296-18 TC
 18 cm, 7"



09296-23 TC
 23 cm, 9"

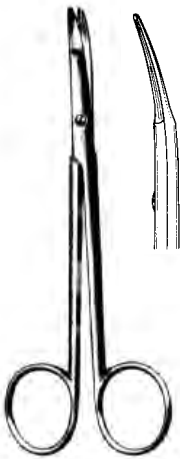
Präparierscheren
Dissecting Scissors
Tijeras de disección
Forbici per dissezione



— SANVENERO —
09302-14 14 cm 09303-14
5½"



— JOSEPH —
09304-14 14 cm 09305-14
5½"

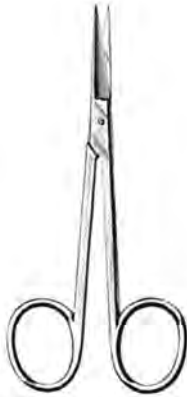


KILNER
09310-12 12 cm **09314-12 TC**
09310-15 15 cm
09312-12 12 cm gerade/straight/recta/retta



— REYNOLDS —
09320-15 15 cm 09321-15
09321-18
09325-15 TC

Chirurgische Scheren, fein
 Operating Scissors, fine
 Tijeras para cirugía, finas
 Forbici per chirurgia, fine



IRIS



09340-09 9 cm

09340-10 10 cm

09340-11 11 cm

09344-11 TC

gerade
 straight
 rectas
 rette



09341-09

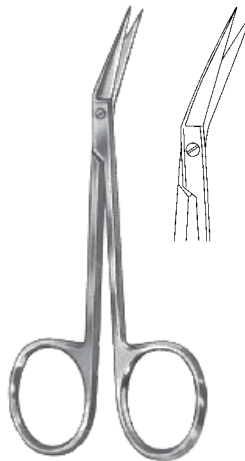
09341-10

09341-11

09345-11 TC

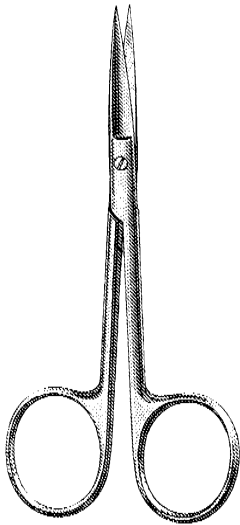
gebogen
 curved
 curvas
 curve

abgewinkelt
 angled
 angulada
 angolata

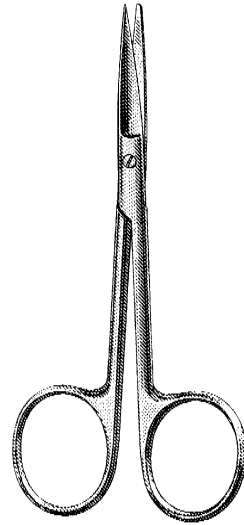


IRIS
 09346-11
 11 cm, 4 $\frac{7}{8}$ "

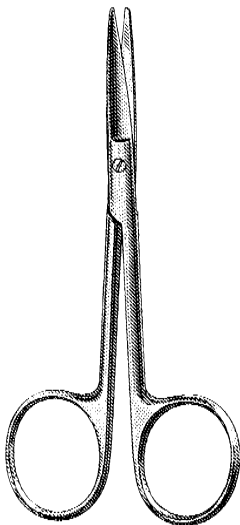
Chirurgische Scheren, Präparierscheren
Operating Scissors, Dissecting Scissors
Tijeras para cirugía, Tijeras de disección
Forbici per chirurgia, Forbici per dissezione



KNAPP
10 cm, 4"
09348-01 09348-02



KNAPP
10 cm, 4"
09348-03 09348-04

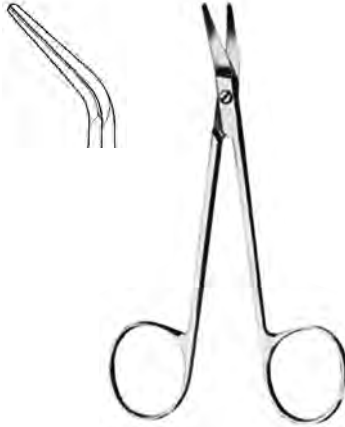


KNAPP
10 cm, 4"
09348-05 09348-06



LITTLER
09349-12
12 cm, 4 3/4"

Präparierscheren, feines Modell
Dissecting Scissors, fine pattern
Tijeras de disección, finas
Forbici per preparazione, modello fino

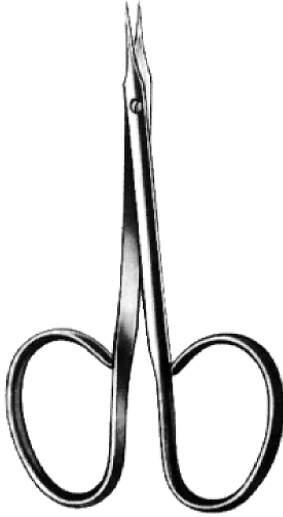


GRAEFE
09350-10
10 cm, 4"

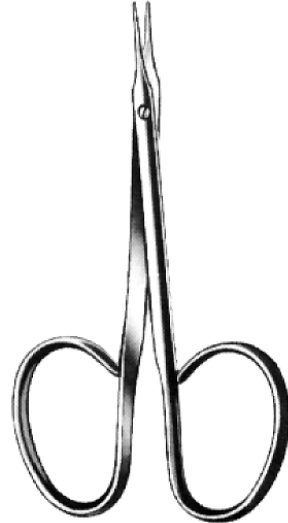


COTTLE
09358-11
11,5 cm, 4½"

Präparierscheren, feines Modell
 Dissecting Scissors, fine pattern
 Tijeras de disección, finas
 Forbici per preparazione, modello fino



— GRADLE —
 09350-09 9,5 cm, 3¾" 09351-09



— —
 09352-09 9,5 cm, 3¾" 09353-09



— —
 09354-10 10 cm, 4" 09355-10



— —
 09356-10 10 cm, 4" 09357-10

Scheren
Scissors
Tijeras
Forbici

Sehnenscheren
Tendon Scissors
Tijeras para tendones
Forbici per tenotomia

Enukleationsschere
Enucleation Scissors
Tijera para enucleación
Forbici per enucleazione



STEVENS
11 cm, 4 $\frac{3}{8}$ "



09360-11 09361-11



09362-11 09363-11



LANDOLT
09381-11
12 cm, 4 $\frac{3}{4}$ "

Nasenscheren - Nasal Scissors - Tijeras nasales - Forbici nasali



— STRABISMUS —
09370-11 09371-11
09374-11 TC 09375-11 TC
11 cm, 4 $\frac{3}{8}$ "



HEYMANN
09401-18
18 cm, 7"

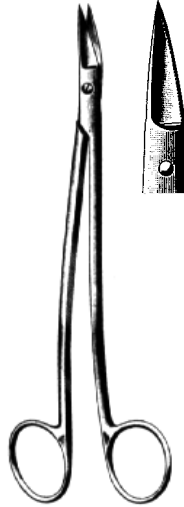


FOMON
09403-15
15 cm, 6"

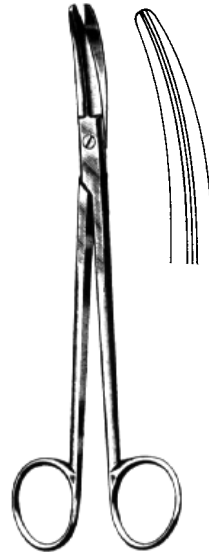
Tonsillen-, Gefäßscheren
Tonsil, Vascular Scissors
Tijeras amígdalas y vasculares
Forbici per tonsilli e vascolari



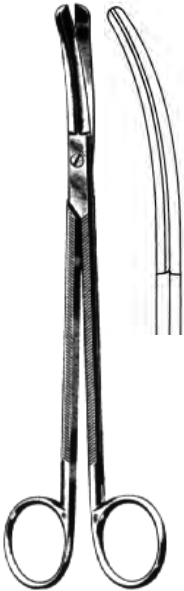
COTTLE
09405-16
09406-16 TC
16 cm, 6¼"



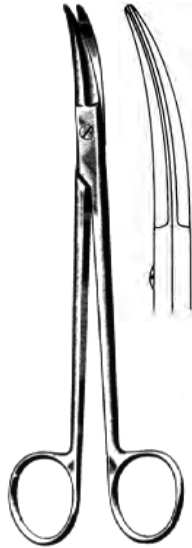
DEAN
09425-17 09427-17
17 cm, 6¾"



BOETTCHER
09435-18
18 cm, 7"



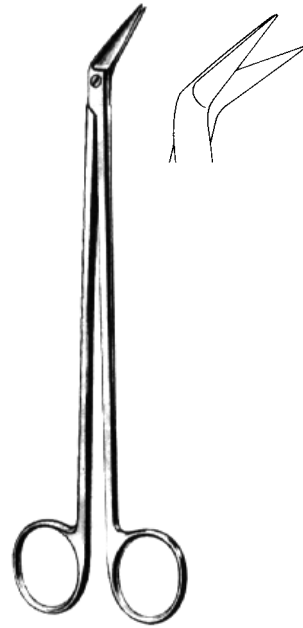
GOOD
09437-19
19 cm, 7½"



PRINCE
09439-17
17 cm, 6¾"



09470-11
11 cm, 4¾"

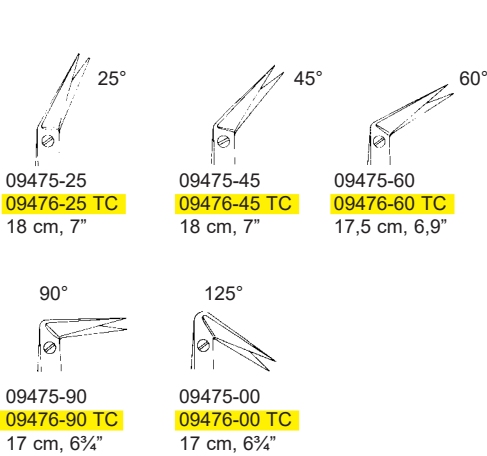


POTTS-DE MARTEL
09473-21
21 cm, 8¼"

Scheren, Thorax und Gefäße
 Scissors, thorax and vascular
 Tijeras, torácicas y vasculares
 Forbici vascolari e toraciche



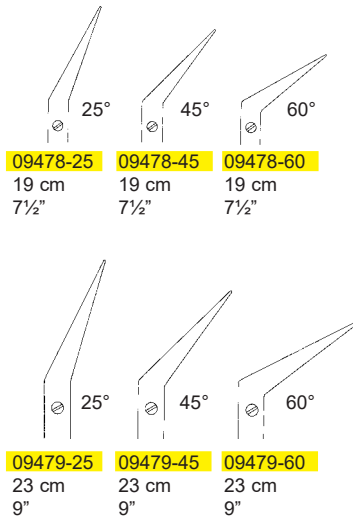
DIETRICH
 09475-25 – 09475-00



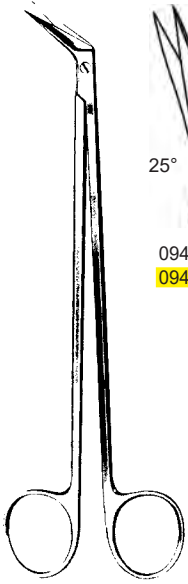
DIETRICH
 09477-01
 17 cm, 6¾"



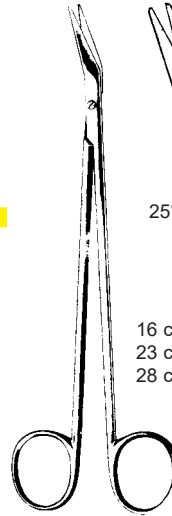
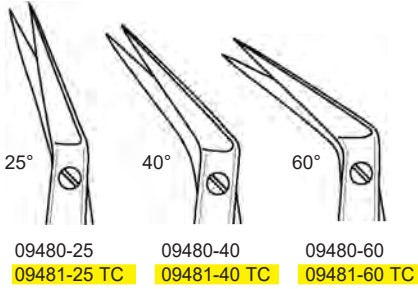
DE BAKEY
 (POTTS-SMITH)



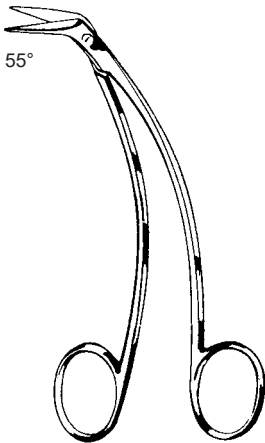
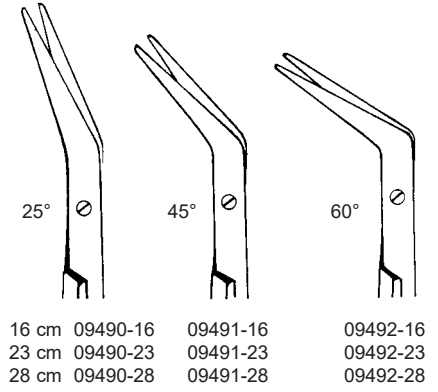
Gefäßscheren
Vascular Scissors
Tijeras vasculares
Forbici vascolari



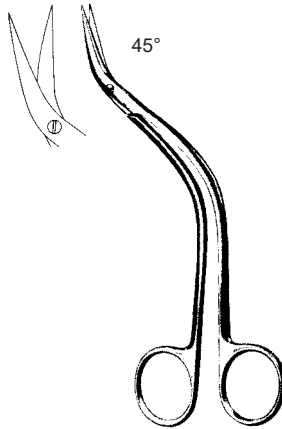
POTTS-SMITH
19 cm, 7½"



DE BAKEY



FAVALORO
09496-15 15 cm, 6"

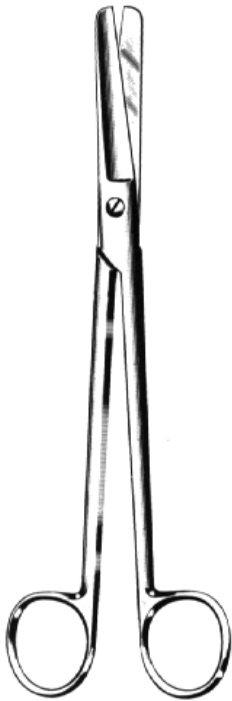


DE BAKEY
09497-15 15,5 cm, 6"



KELLY
09540-16 09541-16
09542-16 TC **09543-16 TC**
 16 cm, 6¼"

Gynäkologische Scheren
 Gynecological Scissors
 Tijeras ginecológicas
 Forbici ginecologiche



SIMS

09510-20 18 cm, 7" 09511-20
 09510-23 23 cm, 9" 09511-23

09516-23 TC 23 cm, 9" 09517-23 TC



09512-20
 09512-23



09513-20
 09513-23



09514-20
 09514-23



SIEBOLD

09523-24 24 cm, 9½"

Gynäkologische Scheren
Gynecological Scissors
Tijeras ginecológicas
Forbici ginecologiche

Parametriumscheren - Parametrium scissors - Tijeras para parametrio - Forbici per parametrio



REDA

09505-23 TC	23 cm, 9"
09505-26 TC	26 cm, 10¼"
09505-30 TC	30 cm, 12"



09507-23 TC	23 cm, 9"
09507-26 TC	26 cm, 10¼"
09507-30 TC	30 cm, 12"



WERTHEIM

09525-22 22,5 cm, 8,9"



DOYEN

09530-17 09531-17
17,5 cm, 6,9"



DUBOIS

09536-27 09537-27
27 cm, 10½"

Episiotomiescheren, Nabelschnurscheren
 Episiotomy Scissors, Umbilical Scissors
 Tijeras para episiotomía, Tijeras umbilicales
 Forbici per episiotomia, Forbici ombelicali

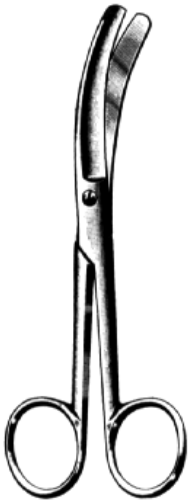


gezahnt
 saw edge
 dentadas
 dentellata

WALDMANN
 09548-18
 18 cm, 7"



U.S.A. Mod.
 09550-10
 10,5 cm, 4"



BUSCH
 09551-16
 16 cm, 6¼"

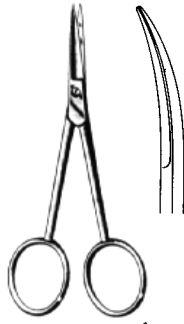


SCHUMACHER
 09553-16
 16 cm, 6¼"

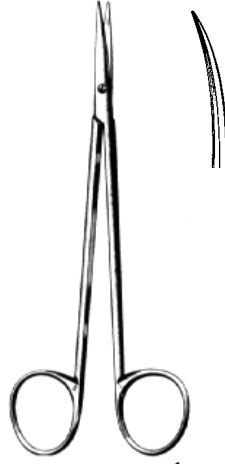


BRAUN-STADLER
 09560-14 14,5 cm, 5¾"
 09560-22 22,0 cm, 8¾"

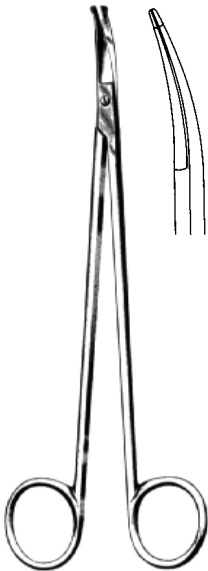
Neurochirurgische Scheren, Gefäßschere, Präparierscheren
 Neurosurgical Scissors, Vascular Scissors, Dissecting Scissors
 Tijera para neurocirugía, Tijeras vasculares, Tijeras de disección
 Forbici per neurochirurgia, Forbici vascolari, Forbici per preparazione



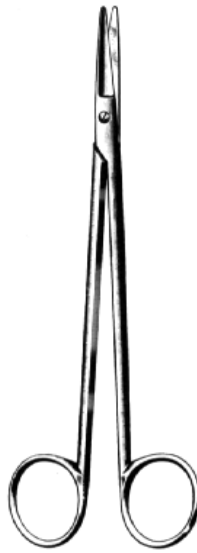
09580-11 09581-11
 11 cm, 4 $\frac{3}{8}$ "



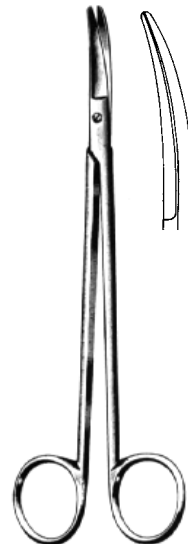
09582-15 09583-15
 15 cm, 6"



STRULLY
 09601-22
 22 cm, 8 $\frac{3}{4}$ "



TOENNIS-ADSON
 09610-18
09610-18 TC
 18 cm, 7"



TOENNIS-ADSON
 09611-18
09611-18 TC
 18 cm, 7"

Knorpelscheren, Nasenschere, Gefäßscheren
 Cartilage Scissors, Nasel Scissors, Vascular Scissors
 Tijeras para cartilago, Tijeras nasales, Tijeras vasculares
 Forbici per cartilagine, Forbici nasali, Forbici vascolari



gezahnt
 saw edge
 dentadas
 dentellata

MARTIN
 09613-20
 18 cm, 7"



McINDOE
 09614-19
 19 cm, 7½"

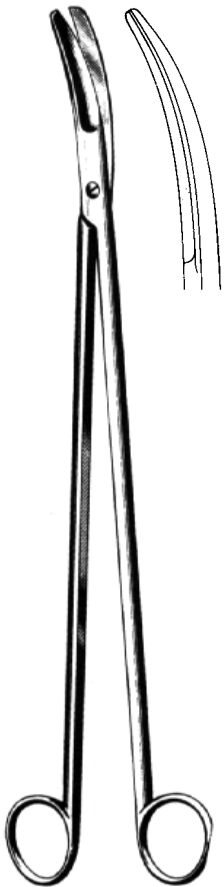


FOMON
 09617-13
 13 cm, 5½"

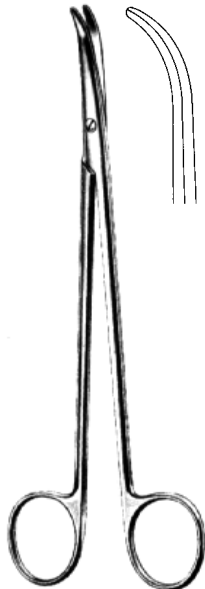


SCHMIEDEN-TAYLOR
 09619-17
 17 cm, 6¾"

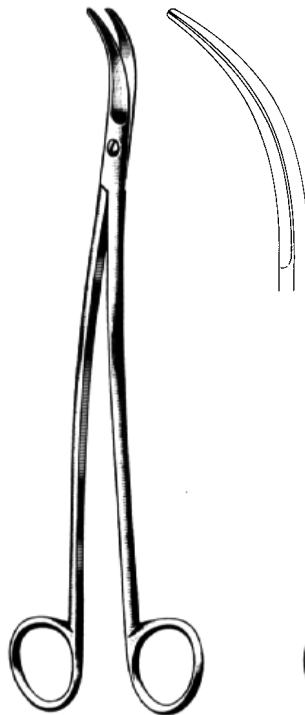
Gefäßscheren, Präparierscheren
Vascular Scissors, Dissecting Scissors
Tijeras vasculares, Tijeras de disección
Forbici vascolari, Forbici per preparazione



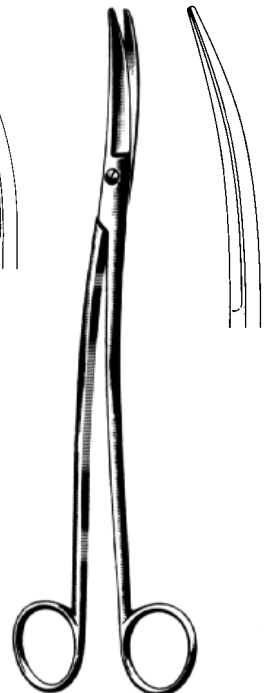
CRAFOORD
09641-30
30 cm, 11¼"



THOREK
09643-19 19 cm, 7½"
09643-25 25 cm, 10"



SATINSKY
09651-24
24,5 cm, 9½"

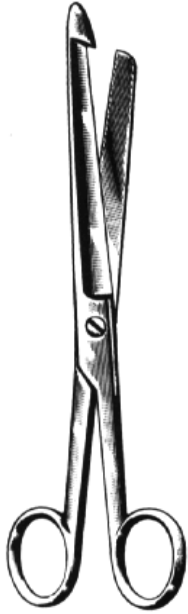


KLINKENBERGH-LOTH
09661-23
23 cm, 9"

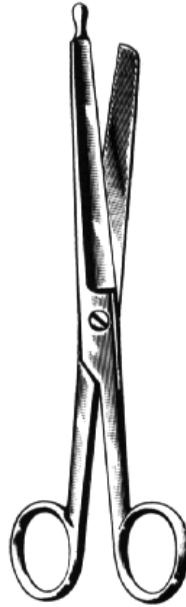
Darmscheren, Nagelspaltschere, Fadenscheren
 Enterotomy Scissors, Nail Splitting Scissors, Stitch Scissors
 Tijeras para intestino, Tijeras para hender uña, Tijeras para hilos
 Forbici per enterotomia, Forbici per staccare unghie, Forbici per legature



FERGUSSON
 09770-18
 18 cm, 7"



09772-21
 21 cm, 8¼"



09774-21
 21 cm, 8¼"



— SYSTRUNK —
 09775-13 09777-13
 13 cm, 5½"



SPENCER
 09802-09
 9 cm, 3½"



SPENCER
 09802-11
 11 cm, 4¾"



NORTHBENT
 09803-09 9 cm, 3½"
 09803-13 13 cm, 5½"



LITTAUER
 09804-14
 14 cm, 5½"



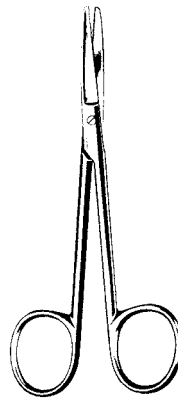
HEATH
 09809-15
 15 cm, 6"

Zahnfleischscheren, feine Scheren, Drahtschere
 Gum Scissors, Delicate Scissors, Wire Cutting Scissors
 Tijeras para encías, Tijeras finas, Tijeras para alambre
 Forbici per gengiva, Forbici delicate, Forbici per filo di metallo

1 Schneide gezahnt
 1 blade toothed
 1 hoja dentada
 1 taglio della lama dentellato



— GOLDMAN-FOX —
 09820-13 13 cm, 5 1/8" 09821-13



WAGNER
 12 cm, 4 3/4"

gerade
 straight
 rectas
 rette



Fig. 1
 09828-12



Fig. 2
 09826-12



Fig. 3
 09824-12

gebogen
 curved
 curvas
 curve



Fig. 1
 09823-12



Fig. 2
 09829-12



Fig. 3
 09825-12



QUINBY
 09827-12 12 cm, 4 3/4"



UNIVERSAL
 09831-12 12 cm, 4 3/4"
 09835-12 TC 12 cm, 4 3/4"

Kronenscheren
Crown Scissors
Tijeras para coronas
Forbici per corona



09850-10
gerade spitz
straight pointed
rectas agudas
rette acute

09851-10
gebogen spitz
curved pointed
curvas agudas
curve acute

BEEBEE
10,5 cm, 4"

Zahnfleischscheren
 Gum Scissors
 Tijeras para encias
 Forbici per gengiva



LA GRANGE
 09854-11
 11,5 cm, 4½"



LOCKLIN
 09859-16
 16 cm, 6¼"

gezahnt
 saw edge
 dentadas
 dentellata



LOCKLIN
 09860-16
 16,5 cm, 6½"

gezahnt
 saw edge
 dentadas
 dentellata

Verbandscheren, Gipsschere
 Bandage Scissors, Plaster Scissors
 Tijeras para vendajes, Tijeras para yeso
 Forbici per bendaggi, Forbici per gesso

Gaze
 Gauze
 Gaza
 Garza



SMITH US ARMY
 09898-20
 18 cm, 7"



LISTER
 9 cm, 3½" 09901-09
 11 cm, 4¾" 09901-11
 14 cm, 5½" 09901-14 09905-14 TC
 18 cm, 7" 09901-18 09905-18 TC
 18 cm, 7" 09901-20



LISTER
 09906-18 18 cm, 7"
 09906-20 18 cm, 7"



BERGMANN
 09911-23
 23 cm, 9"

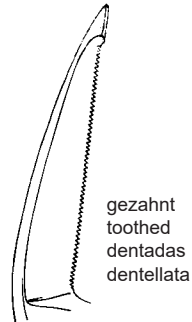
Gipsscheren, Verbandscheren
 Plaster Scissors, Bandage Scissors
 Tijeras para yeso, Tijeras para vendajes
 Forbici per gesso, Forbici per bendaggi



ESMARCH
 09913-20 18 cm, 7"
 09913-22 22 cm, 8¾"



SEUTIN
 09915-23
 23 cm, 9"



gezahnt
 toothed
 dentadas
 dentellata

REDA EXCENTER
 09921-16 16 cm, 6¼"
 09921-19 19 cm, 7½"

Verbandscheren, Gipsschere
 Bandage Scissors, Plaster Scissors
 Tijeras para vendajes, Tijeras para yeso
 Forbici per bendaggi, Forbici per gesso



KNOWLES
 09930-14
 14 cm, 5½"



KNOWLES
 09931-14
 14 cm, 5½"



LORENZ
 09933-23
 23 cm, 9"



BRUNS
 09935-23 23 cm, 9" 09939-23 TC
 09937-23 23 cm, 9"



09941-20
 18 cm, 7"

in verschiedenen Farben lieferbar
 in different colours available
 en diferentes colores disponibles
 in differenti colori disponibile



UNIVERSAL
 09950-15 15 cm, 6"
 09950-18 18 cm, 7"



Supercut Scheren, gezahnt
 Supercut Scissors, saw edge
 Tijeras Supercut, dentadas
 Forbici Supercut, dentellate



09960-14 09961-14
 14,5 cm, 5 3/4"



MAYO
 09962-14 14,5 cm 09963-14
 09962-17 17,0 cm 09963-17
 09962-23 23,0 cm 09963-23



MAYO-STILLE
 09964-15 15,0 cm 09965-15
 09964-17 17,0 cm 09965-17



BABY METZENBAUM
 09966-11 09967-11
 11,5 cm, 4 1/2"



METZENBAUM
 09970-14 14,5 cm 09971-14
 09970-18 18,0 cm 09971-18
 09970-20 20,0 cm 09971-20
 09970-23 23,0 cm 09971-23

Supercut Scheren, gezahnt
 Supercut Scissors, saw edge
 Tijeras Supercut, dentadas
 Forbici Supercut, dentellate



IRIS
 09980-11 09981-11
 11,5 cm, 4½"



WAGNER
 09982-12 09983-12
 12 cm, 4¾"



STEVENS
 09984-11 09985-11
 11,5 cm, 4½"



LISTER
 09990-14 14,5 cm, 5¾"
 09990-18 18,0 cm, 7"



REYNOLDS
 09993-15 15 cm, 6"
 09993-18 18 cm, 7"

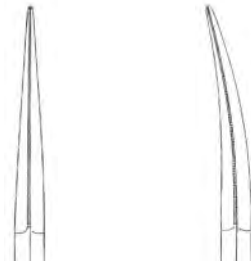


KILNER/RAGNELL
 09995-12 12 cm, 4¾"

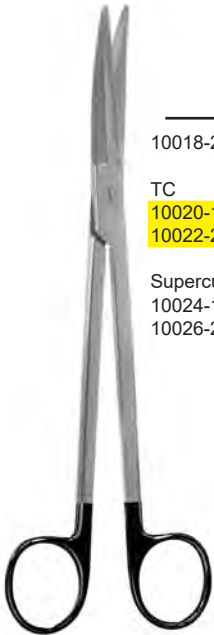
Face-Lift-Scheren
 Face-Lift-Scissors
 Tijeras para Face-Lift
 Forbici per Face-Lift



GORNEY
 19 cm, 7½"



- | | |
|-------------------|-------------------|
| 10010-19 | 10011-19 |
| 10012-19 TC | 10013-19 TC |
| 10014-19 Supercut | 10015-19 Supercut |



REES

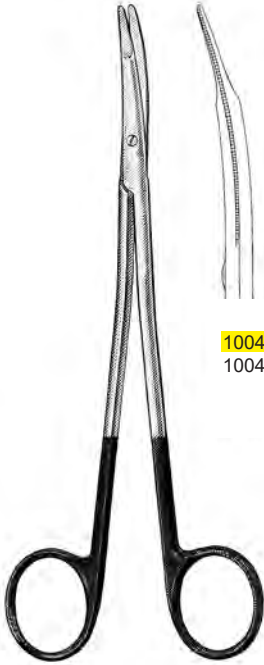
- | | | |
|-----------------|--------------|----------|
| 10018-20 | 20,5 cm, 8" | 10019-20 |
| TC | | |
| 10020-17 | 17,0 cm, 6¾" | 10021-17 |
| 10022-20 | 20,5 cm, 8" | 10023-20 |
| Supercut | | |
| 10024-17 | 17,0 cm, 6¾" | 10025-17 |
| 10026-20 | 20,5 cm, 8" | 10027-20 |



KAYE

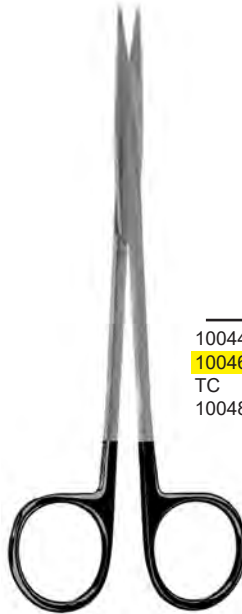
- | | | |
|-----------------|--------------|----------|
| TC | | |
| 10028-14 | 14,5 cm, 5¾" | 10029-14 |
| 10030-18 | 18,5 cm, 7¼" | 10031-18 |
| 10032-23 | 23,0 cm, 9" | 10033-23 |
| Supercut | | |
| 10034-14 | 14,5 cm, 5¾" | 10035-14 |
| 10036-18 | 18,5 cm, 7¼" | 10037-18 |
| 10038-23 | 23,0 cm, 9" | 10039-23 |

Face-Lift-Scheren
 Face-Lift-Scissors
 Tijeras para Face-Lift
 Forbici per Face-Lift



10041-18 TC
 10042-18 Supercut

FREEMAN
 18 cm, 7"



10044-14

10046-14 TC

TC

10048-14 Supercut

10045-14

10047-14 TC

10049-14 Supercut

PECK JOSEPH
 14,5 cm, 5¾"

Face-Lift-Scheren
Face-Lift-Scissors
Tijeras para Face-Lift
Forbici per Face-Lift



spitz
pointed
agudas
acute

WESTCOTT
10102-11
11 cm, 4 $\frac{3}{8}$ "



stumpf
blunt
romas
smusse

WESTCOTT
10104-11
11 cm, 4 $\frac{3}{8}$ "



spitz
pointed
agudas
acute

NOYES
10110-12 10111-12
12 cm, 4 $\frac{3}{8}$ "



WECKER
11 cm, 4 $\frac{3}{8}$ "



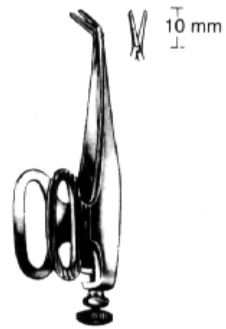
10113-11
spitz
pointed
agudas
acute



10115-11
spitz / stumpf
pointed / blunt
agudas / romas
acute / smusse



10117-11
stumpf
blunt
romas
smusse



BARRAQUER
10119-10 5,5 cm, 2.2"
(Colibri)

Mikro-Scheren
 Micro-Scissors
 Micro-Tijeras
 Micro-Forbici



10120-16
 10120-18
 10120-22

16,0 cm, 6¼"
 18,5 cm, 7¼"
 22,5 cm, 8,9"



10121-16
 10121-18
 10121-22

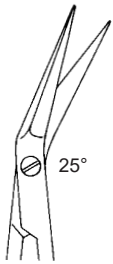


16,0 cm, 6¼"
 18,5 cm, 7¼"
 22,5 cm, 8,9"

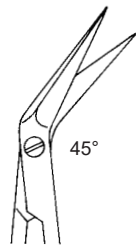
10123-16
 10123-18
 10123-22

Mikro-Scheren
 Micro-Scissors
 Micro-Tijeras
 Micro-Forbici

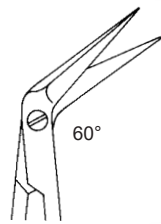
15 mm



10126-25



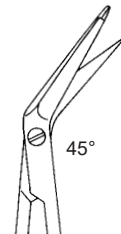
10126-45



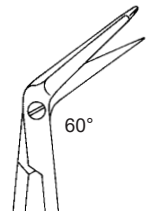
10126-60



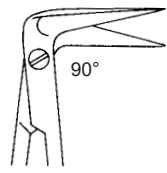
10127-25



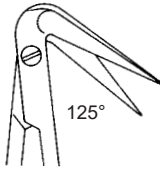
10127-45



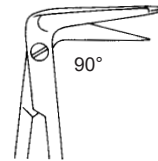
10127-60



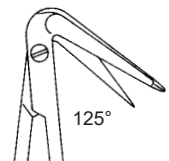
10126-90



10126-00



10127-90



10127-00



REDA
 18 cm, 7"

Mikro-Scheren
Micro-Scissors
Micro-Tijeras
Micro-Forbici



10128-09
9 cm, 3½"



10128-15 - 10130-15
15 cm, 6"

10128-15
gerade
straight
rectas
rette

10129-15
gebogen
curved
curvas
curvo

10130-15
gebogen, 1 Schneide gezahnt
curved, 1 blade toothed
curvas, 1 hoja dentada
curva, 1 lama dentellata

halbscharf
semi-sharp
medio roma
lame semi smusse



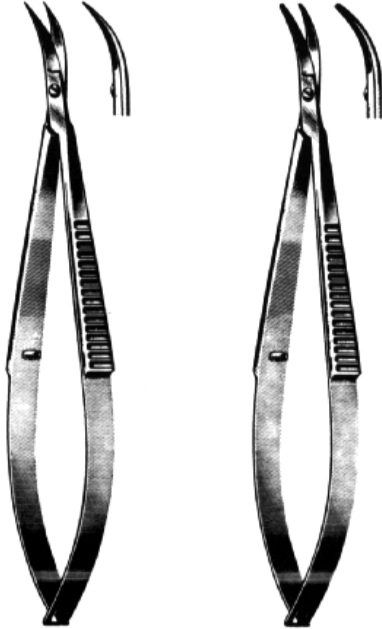
HEPP-SCHEIDEL
10131-14 14 cm, 5½"
10131-18 18 cm, 7"



HEPP-SCHEIDEL HEPP-SCHEIDEL
10137-01 10137-02
18 cm, 7" 18 cm, 7"
spitz stumpf
pointed blunt
agudas romas
acute smusse

Augen-, Mikroscheren
 Ophthalmic, Micro Scissors
 Tijeras oculares, micro tijeras
 Forbici oculistiche, micro chirurg.

Iridektomie, Iridectomy, Iridectomia, iridectomia



CASTROVIEJO 10133-10 10 cm, 4"
 CASTROVIEJO 10135-10 10 cm, 4"



VANNAS 10140-08 8 cm, 3 1/8"



VANNAS 10141-08 8 cm, 3 1/8"



10142-08 kniegebogen angular acodada angolate



10143-08 aufgewinkelt angled up acodada hacia arriba angolate verso l'alto

Hornhautscheren, Corneal scissors, Tijeras corneales, Forbici corneali



CASTROVIEJO 10151-11 11 cm, 4 3/8"



CASTROVIEJO 10153-11 11 cm, 4 3/8"



CASTROVIEJO 10155-11 11 cm, 4 3/8"

Mikro-Scheren
 Micro-Scissors
 Micro-Tijeras
 Micro-Forbici



— REDA —
 10202-18 - 10203-18
 18 cm, 7"

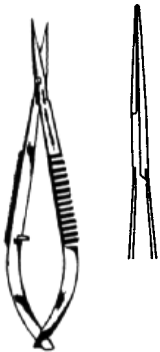


10313-14
 14 cm
 5½"



10313-16
 16 cm
 6"

GOMEL



REDA micro
 10320-09
 9 cm, 3½"



10330-19



10331-19



10333-19

REDA
 10330-19 - 10333-19
 18,5 cm, 7¼"

Anatomische und chirurgische Pinzetten
 Dressing and Tissue Forceps
 Pinzas de disección, sin/con dientes
 Pinze per dissezione, chirurgiche/anatomiche

STANDARD



USA

STILLE

cm				
10,5, 4¼"	11102-10			
11,5, 4½"	11102-11			
12,0, 4¾"			11104-12	
13,0, 5⅞"	11102-13		11104-13	11106-13
14,5, 5¾"	11102-14	11103-14	11104-14	
15,0, 6"			11104-15	11106-15
16,0, 6¼"	11102-16			
18,0, 7"	11102-18		11104-18	
20,0, 8"	11102-20			
21,0, 8¼"			11104-21	
25,0, 10"	11102-25		11104-25	
30,0, 12"	11102-30			


 schmal
 narrow
 estrecha
 stretta


POTTS-SMITH


 POTTS-SMITH
 1x2

cm				
11,5 4½"	11110-11			
13,0 5⅞"	11110-13			
14,5 5¾"	11110-14	11114-14 TC		
16,0 6¼"	11110-16	11114-16 TC		
18,0 7"	11110-18		11112-18	11116-18 TC
20,0 8"	11110-20	11114-20 TC		
21,0 8¼"			11112-21	11116-21 TC
25,0 10"	11110-25	11114-25 TC	11112-25	11116-25 TC
30,0 12"	11110-30			

Chirurgische Pinzetten
Tissue Forceps
Pinzas de disección, con dientes
Pinze per dissezione, chirurgiche

STANDARD



1x2



1x2



1x2



1x2

schmal
narrow
estrecha
stretta

cm				
10,5	4¼"	11120-10		
11,5	4½"	11120-11		
12,0	4¾"		11122-12	
13,0	5½"	11120-13	11122-13	11130-13
14,5	5¾"	11120-14	11122-14	11130-14
15,0	6"			11124-15
15,5	6"		11122-15	
16,0	6¼"	11120-16		11130-16
18,0	7"	11120-18	11122-18	11130-18
20,0	8"	11120-20		11130-20
21,0	8¼"		11122-21	
25,0	10"	11120-25	11122-25	
30,0	12"	11120-30		



1x2



2x3



3x4



4x5

cm				
11,5	4½"	OEHLER	11140-11	
13,0	5½"		11140-13	
14,5	5¾"		11140-14	11150-13
16,0	6¼"	11132-16 TC	11140-16	11150-14
18,0	7"	11132-18 TC	11140-18	11150-16
20,0	8"	11132-20 TC	11140-20	
25,0	10"	11132-25 TC	11140-25	11160-13
				11160-14
				11160-16

Anatomische und chirurgische Pinzetten
 Dressing and Tissue Forceps
 Pinzas de disección, sin/con dientes
 Pinze per dissezione, chirurgiche/anatomiche



ADSON
 11170-12 12,0 cm, 4¾"
 11170-15 15,0 cm, 6"
 11170-18 18 cm, 7"



ADSON
 11170-12G 12,0 cm, 4¾"

glattes Maul
 smooth jaws
 boca lisa
 morso liscio



ADSON
 11174-12 TC 12,0 cm, 4¾"
 11174-15 TC 15,0 cm, 6"



ADSON micro
 11176-12 12,0 cm, 4¾"
 11176-15 15,0 cm, 6"



ADSON-DEBAKEY atraumatic
 11177-12
 12,0 cm, 4¾"



ADSON
 11178-12
 12,0 cm, 4¾"

1x2



ADSON
 11179-12
 12 cm, 4¾"

2x3

Anatomische und chirurgische Pinzetten
 Dressing and Tissue Forceps
 Pinzas de disección, sin/con dientes
 Pinze per dissezione, anatomiche/chirurgiche



ADSON
 11180-12 12,0 cm, 4¾"
 11180-15 15,0 cm, 6"
 11180-18 18,0 cm, 7"



ADSON
 11181-12 TC 12,0 cm, 4¾"
 11181-15 TC 15,0 cm, 6"



ADSON (micro)
 11181-12M TC
 12 cm, 4¾"



ADSON micro
 11186-12 12,0 cm, 4¾"
 11186-15 15,0 cm, 6"



ADSON
 11187-12
 12 cm, 4¾"



ADSON-BROWN
 11188-12 12,0 cm, 4¾"
 11188-15 15,0 cm, 6"
 11189-12 TC 12,0 cm, 4¾"

Anatomische und chirurgische Pinzetten
 Dressing and Tissue Forceps
 Pinzas de disección, sin/con dientes
 Pinze per dissezione, chirurgiche/anatomiche



BROWN
 11189-15 15,0 cm, 6"
 11189-20 20,0 cm, 8"
 11189-25 25,0 cm, 10"



GRAEFE
 11190-10 10,5 cm, 4,1"



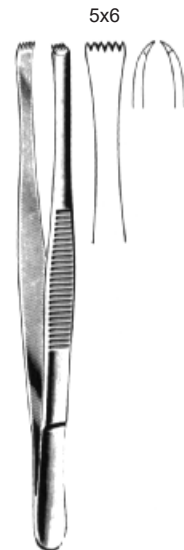
WAUGH
 11187-18 18 cm, 7"
 11187-20 18 cm, 7"
 11187-25 25 cm, 10"
 11187-30 30 cm, 11¼"



CUSHING
 11220-17
11224-17 TC
 17,0 cm, 6¾"



CUSHING
 11222-17
11225-17 TC
 17,0 cm, 6¾"



LERCHE
 11232-15
 15,0 cm, 6"

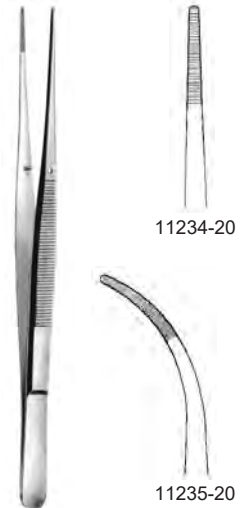
Anatomische und chirurgische Pinzetten, Faßpinzetten
 Dressing and Tissue Forceps
 Pinzas de disección, sin/con dientes
 Pinze per dissezione, chirurgiche/anatomiche



BROPHY
 11231-20
 20,0 cm, 8"



BROPHY
 11233-20
 20,0 cm, 8"



BROPHY
 20,0 cm, 8"



ADLERKREUTZ
 11236-15 15,0 cm, 6"
 11236-20 20,0 cm, 8"



DUEHRSEN
 11237-20
 18 cm, 7"



LANE
 11240-14
 14,5 cm, 5¾"



LANE
 11242-14
 14,5 cm, 5¾"

Anatomische und chirurgische Pinzetten, Faßpinzetten
 Dressing and Tissue Forceps
 Pinzas de disección, sin/con dientes
 Pinze per dissezione, chirurgiche/anatomiche



FERRIS-SMITH
 11246-18
 18,0 cm, 7"



FERRIS-SMITH
 11248-18
 18,0 cm, 7"



DUVAL
 11250-14
 14,5 cm, 5 3/4"



COLLIN-DUVAL
 11252-20
 20,0 cm, 8"



Russ. Mod.
 11256-15 15,0 cm, 6"
 11256-20 20,0 cm, 8"
 11256-25 25,0 cm, 10"



McINDOE
 11257-15
 15,0 cm, 6"



McINDOE
 11258-15 15,0 cm, 6"
 11259-15 TC 15,0 cm, 6"



RESANO
 11259-18 18,0 cm, 7"
 11259-20 20,0 cm, 8"
 11259-23 23,0 cm, 9"

Anatomische und chirurgische Pinzetten
 Dressing and Tissue Forceps
 Pinzas de disección, sin/con dientes
 Pinze per dissezione, chirurgiche/anatomiche



SEMKEN

11260-12	12,5 cm, 5"
11260-15	15,5 cm, 6"
11261-15 TC	15,5 cm, 6"



1x2

SEMKEN

11270-12	12,5 cm, 5"
11270-15	15,5 cm, 6"
11271-15 TC	15,5 cm, 6"
11271-18 TC	18 cm, 7"



1x2

GILLIES

11272-15	15,5 cm, 6"
11273-15 TC	15,5 cm, 6"



15,5 cm, 6"

11274-06
0,6 mm11274-08
0,8 mm11274-10
1,0 mm

GERALD

11302-17	17,5 cm, 6.9"
11302-23	23,0 cm, 9"
11304-17 TC	17,0 cm, 6¾"



GERALD

11303-17	17,5 cm, 6.9"
----------	---------------

Anatomische und chirurgische Pinzetten
 Dressing and Tissue Forceps
 Pinzas de disección, sin/con dientes
 Pinze per dissezione, chirurgiche/anatomiche



GERALD
 11305-17
 17,5 cm, 6.9"



GERALD
 11310-17 17,5 cm, 6.9"
 11312-17 TC 17,5 cm, 6.9"



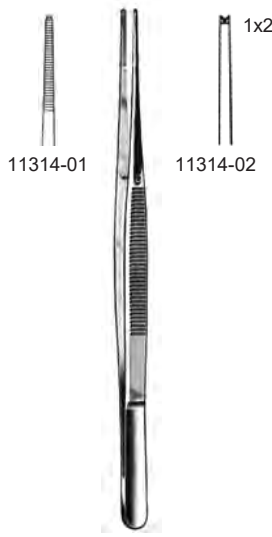
GERALD
 11311-17
 17,5 cm, 6.9"



CUSHING-TAYLOR
 11312-18 TC
 18,5 cm, 7 1/4"



GERALD
 11313-17
 17,5 cm, 6.9"

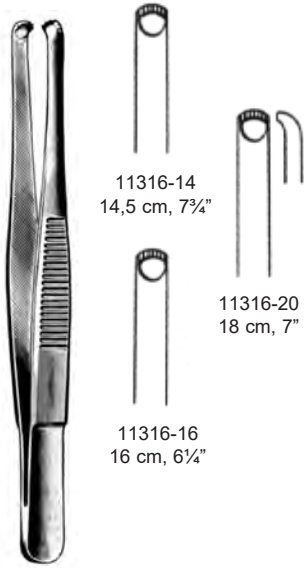


TAYLOR
 17 cm, 6 3/4"



TAYLOR
 17 cm, 6 3/4"

Anatomische und chirurgische Pinzetten
 Dressing and Tissue Forceps
 Pinzas de disección, sin/con dientes
 Pinze per dissezione, chirurgiche/anatomiche

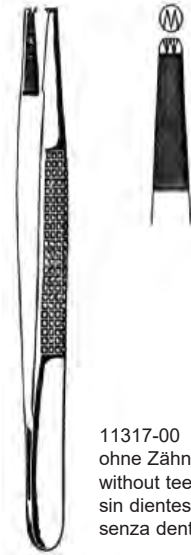


11316-14
14,5 cm, 7 3/4"

11316-20
18 cm, 7"

11316-16
16 cm, 6 1/4"

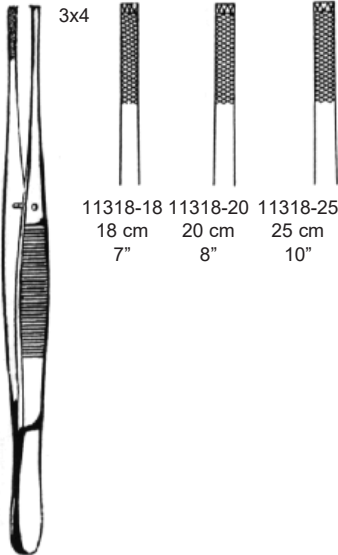
DURANTE



11317-00
ohne Zähne
without teeth
sin dientes
senza denti

- 11317-12 1x2
- 11317-23 2x3
- 11319-12 TC 1x2

BONNEY
18 cm, 7"



3x4

11318-18 18 cm 7"
 11318-20 20 cm 8"
 11318-25 25 cm 10"

STILLE-BARRAYA



OCHSNER
11319-14 14,5 cm 5 3/4"



SINGLEY
11320-18 18 cm, 7"
 11320-23 23 cm, 9"

Anatomische und chirurgische Pinzetten
 Dressing and Tissue Forceps
 Pinzas de disección, sin/con dientes
 Pinze per dissezione, chirurgiche/anatomiche



NELSON
 11322-15 15 cm, 6"
 11322-18 18 cm, 7"
 11322-23 23 cm, 9"



DENIS-BROWNE
 11323-19
 19 cm, 7½"



WANGENSTEEN
 11324-23
 23 cm, 9"



11325-15 TC
 15 cm, 6"



11325-23 TC
 23 cm, 9"



11325-25 TC
 25 cm, 10"

WANGENSTEEN



MAYO
 11326-23 23 cm, 9"



STRASSBURGER
 MODELL

1x2



11328-15
 15 cm, 6"

1x2



11328-20
 18 cm, 7"

Uhrmacherpinzetten
Jeweler Type Forceps
Pinzas de relojero
Pinze da orologiaio

Fig. 1



11401-01
12 cm, 4¾"

Fig. 3



11403-03
12 cm, 4¾"

Fig. 3c



11403-04
11 cm, 4¾"

Fig. 4



11404-04
11 cm, 4¾"

Fig. 5



11405-05
11 cm, 4¾"

Fig. 7



11407-07
12 cm, 4¾"

Splitterpinzetten
Splinter Forceps
Pinzas para espinas
Pinze per schegge



11802-09 9,0 cm, 3½"
11802-10 10,5 cm, 4.1"
11802-11 11,5 cm, 4½"



FEILCHENFELD
11810-07 7,5 cm, 3"
11810-09 9,0 cm, 3½"
11810-11 11,5 cm, 4½"



HUNTER
11812-10
10,5 cm, 4.1"



HUNTER
11813-10
10,5 cm, 4.1"



CARMALT
11816-10
10,5 cm, 4.1"



CARMALT
11817-10
10,5 cm, 4.1"

Splitterzangen
 Splinter Forceps
 Pinzas para espinas
 Pinze per schegge



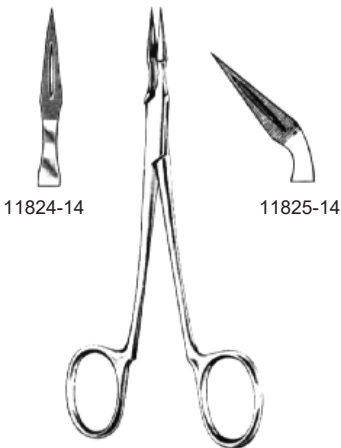
PEET
 11821-11
 11,5 cm, 4½"



11822-13

11823-13

STIEGLITZ
 13,5 cm, 5¼"



11824-14

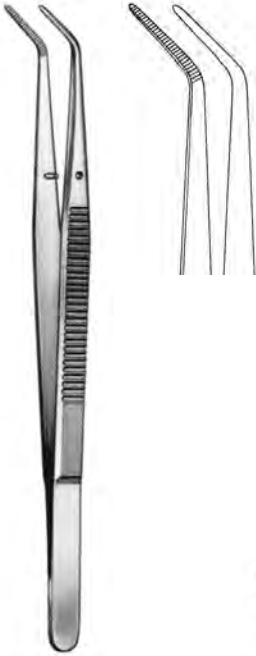
11825-14

ARCHER
 14 cm, 5½"

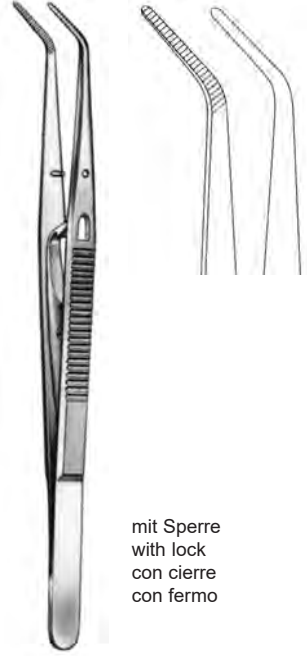


VIRTUS (RALK)
 11828-15
 15 cm, 6"

Zahnpinzetten
Dental Forceps
Pinzas dentales
Pinze dentali



LONDON-COLLEGE
11900-01
15 cm, 6"



LONDON-COLLEGE
11901-05
15 cm, 6"

mit Sperre
with lock
con cierre
con fermo



MERIAM
11910-01
15 cm, 6"

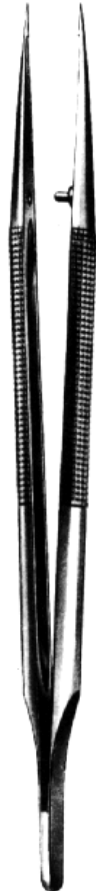
Mikrochirurgie-Pinzetten
Microsurgery Forceps
Pinzas para microcirugía
Pinze per microchirurgia



12102-12
12 cm, 4 $\frac{3}{4}$ "



12103-12
12 cm, 4 $\frac{3}{4}$ "



12104-15
15 cm, 6"



12105-15
15 cm, 6"

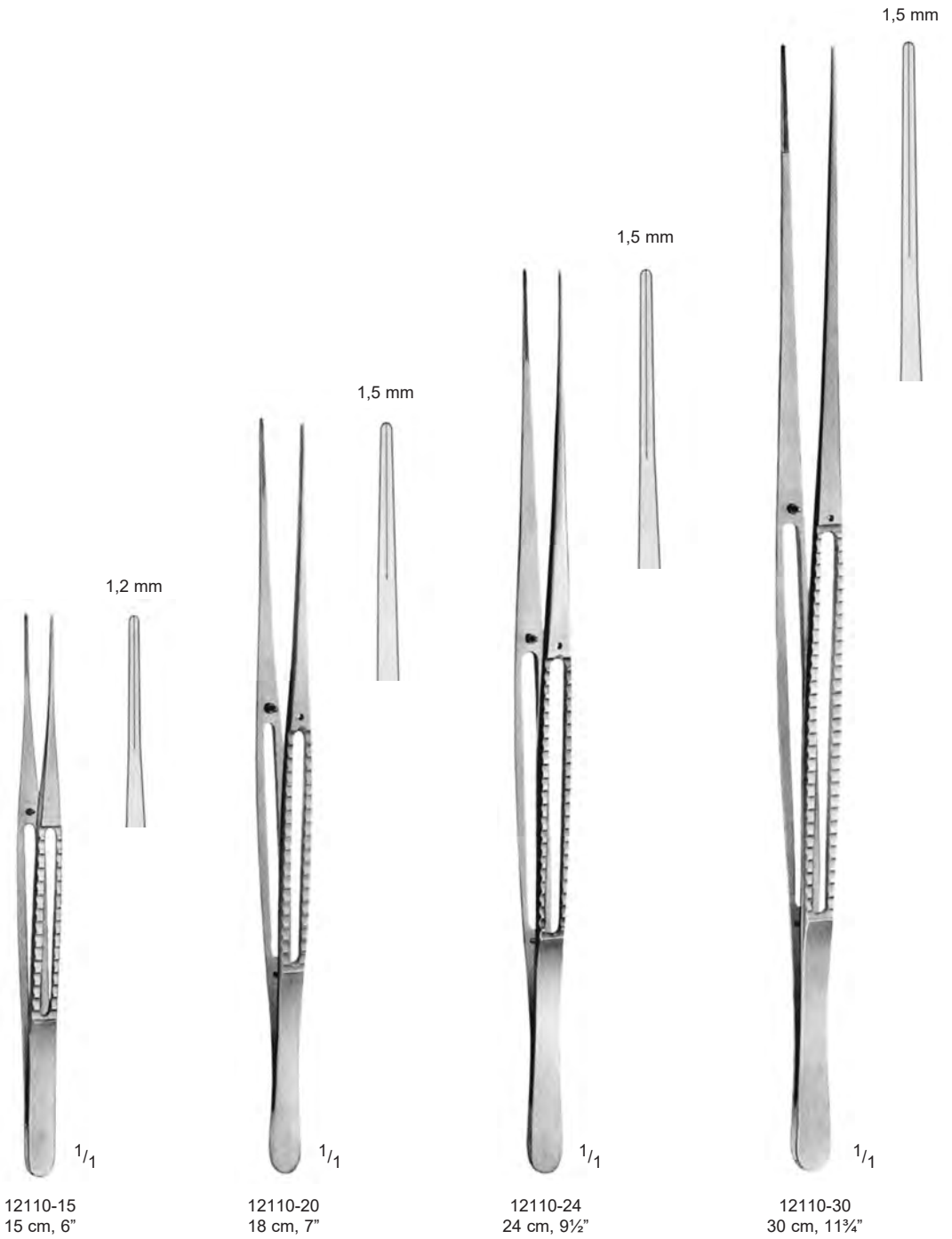


12108-18
18 cm, 7"

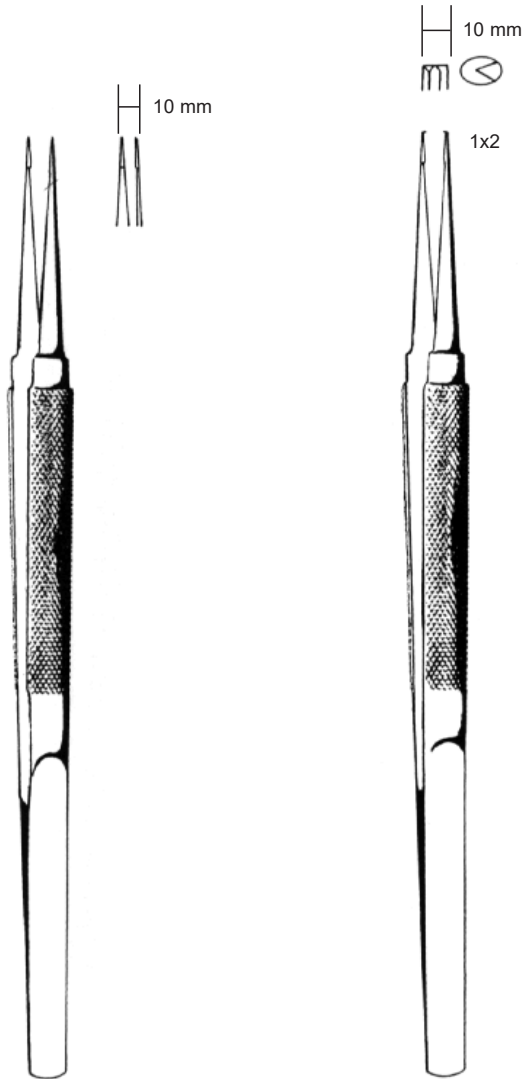


12109-18
18 cm, 7"

Ultra-Light-Pinzetten
 Ultra-Light-Forceps
 Pinzas-Ultra-Ligera
 Pinza-ultra-leggera



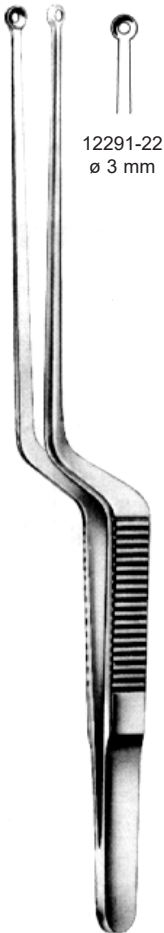
Mikrochirurgie-Pinzetten
 Microsurgery Forceps
 Pinzas para microcirugía
 Pinze per microchirurgia



GOMEL
 12200-16
 16 cm, 6 1/4"

GOMEL
 12201-16
 16 cm, 6 1/4"

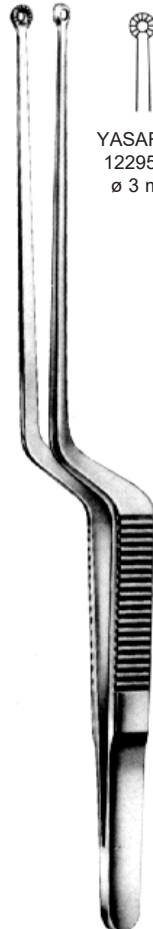
Tumorpinzetten
Tumor forceps
Pinzas para tumores
Pinze per tumori



12291-22
ø 3 mm



12293-22
ø 5 mm



YASARGIL
12295-22
ø 3 mm



HUNT
12297-22
ø 5 mm

YASARGIL
22 cm, 8 3/4"

22 cm, 8 3/4"

Atraumatische Pinzetten
 Atraumatic Tissue Forceps
 Pinzas atraumáticas
 Pinze atraumatiche



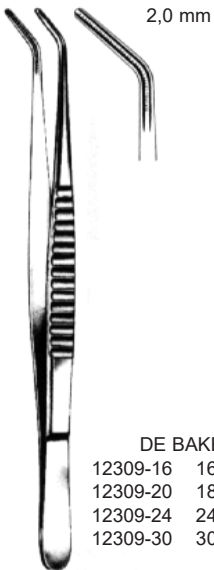
DE BAKEY
 12302-16 16 cm, 6¼"
 12302-20 18 cm, 7"
 12302-24 24 cm, 9½"



DE BAKEY
 12306-16 16 cm, 6¼"
 12306-20 18 cm, 7"
 12306-24 24 cm, 9½"
 12306-30 30 cm, 11¼"



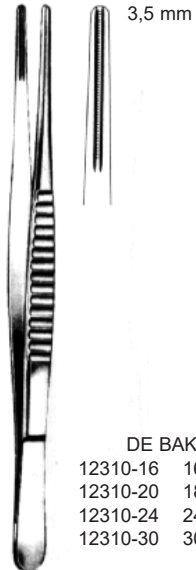
DE BAKEY
 12308-16 16 cm, 6¼"
 12308-20 18 cm, 7"
 12308-24 24 cm, 9½"
 12308-30 30 cm, 11¼"



DE BAKEY
 12309-16 16 cm, 6¼"
 12309-20 18 cm, 7"
 12309-24 24 cm, 9½"
 12309-30 30 cm, 11¼"

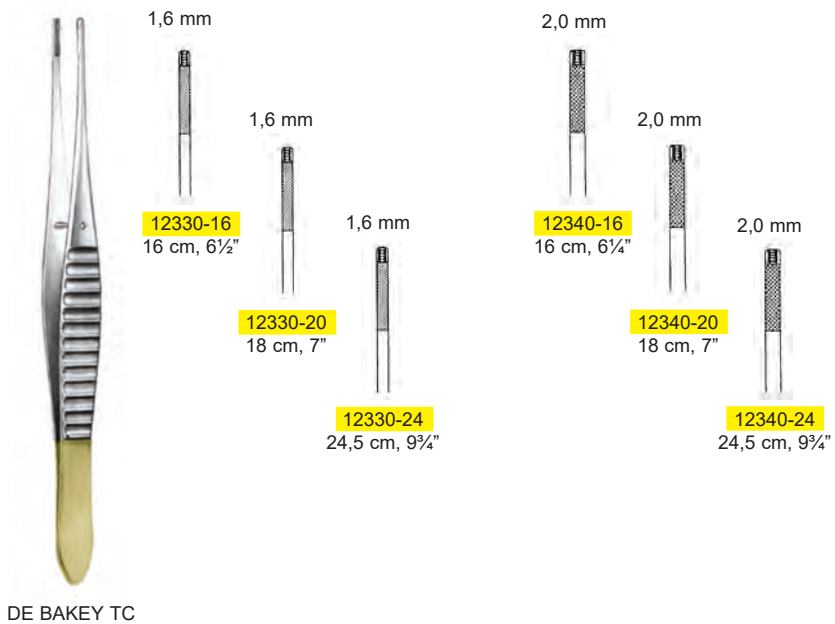
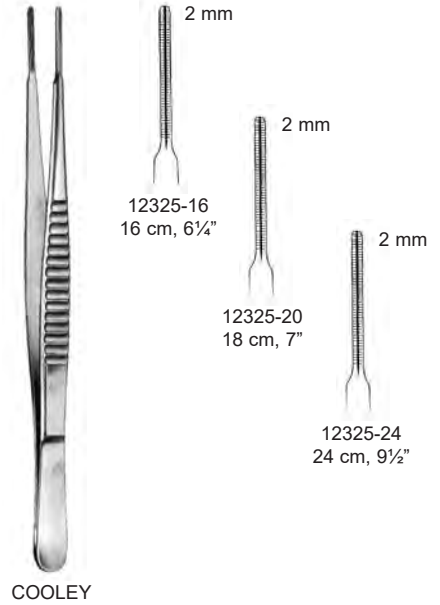
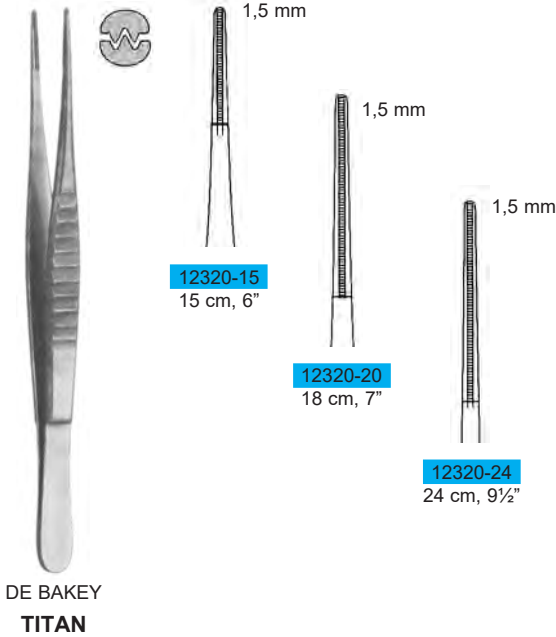


DE BAKEY
 12304-16 16 cm, 6¼"
 12304-20 18 cm, 7"
 12304-24 24 cm, 9½"
 12304-30 30 cm, 11¼"



DE BAKEY
 12310-16 16 cm, 6¼"
 12310-20 18 cm, 7"
 12310-24 24 cm, 9½"
 12310-30 30 cm, 11¼"

Atraumatische Pinzetten
 Atraumatic Tissue Forceps
 Pinzas atraumáticas
 Pinze atraumatiche



Atrauma-Bulldogklemmen
 Atrauma-Bulldog Clamps
 Clamps Atrauma Bulldog
 Pinze Atrauma Bulldog



13090-40
40 mm / 1½"

13090-45
45 mm / 1¾"

13090-50
50 mm / 2"



13091-40
40 mm / 1½"

13091-45
45 mm / 1¾"

13091-50
50 mm / 2"



DE BAKEY
13099-07
73 mm / 2¾"



GLOVER
13098-06
57 mm / 2⅝"



GREGORY



13094-07
9 cm, 3½"



13094-11
11 cm, 4¼"



GREGORY

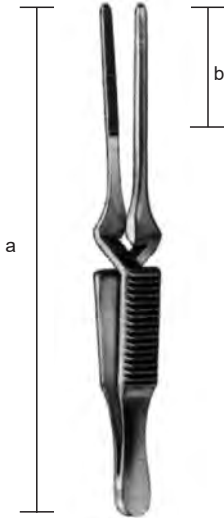


13095-01
11 cm, 4¼"

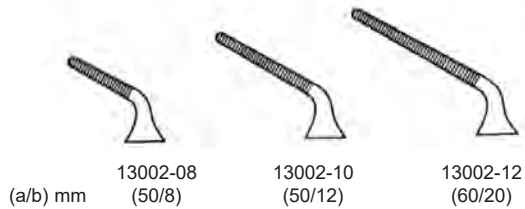
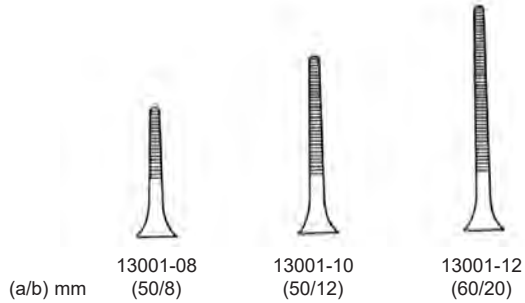


13095-02
11 cm, 4¼"

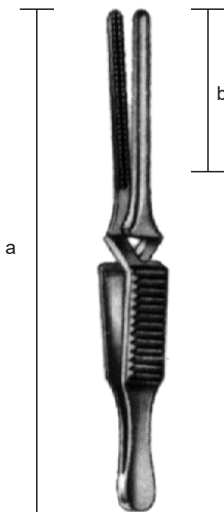
Mini-Bulldogklemmen
 Mini Bulldog Clamps
 Clamps Bulldog Mini
 Pinze Bulldog Mini



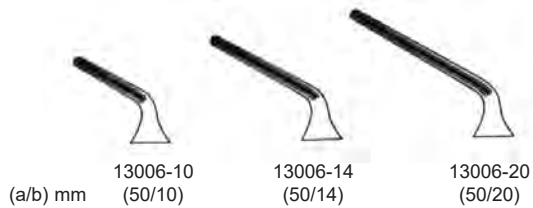
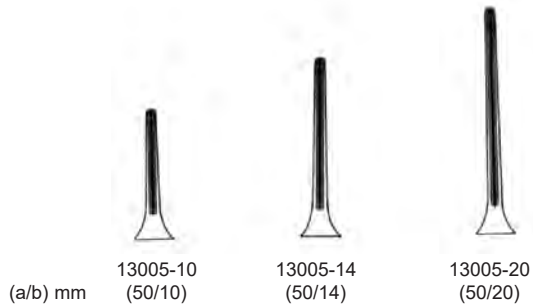
DIETHRICH



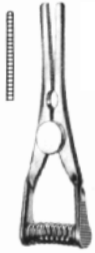
Atrauma



DEBAKEY-DIETHRICH

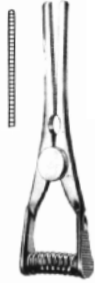


Titan-Atrauma-Bulldogklemmen
 Titanium Atrauma Bulldog Clamps
 Titan Clamp Bulldog
 Titan Pinze Bulldog



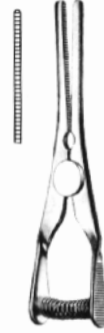
3 cm, 1.2"

Vene **13010-30**
 Arterie **13011-30**



3,5 cm, 1.4"

13010-35
13011-35



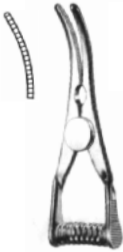
4 cm, 1½"

13010-40
13011-40



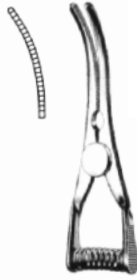
5 cm, 2"

13010-50
13011-50



3 cm, 1.2"

Vene **13012-30**
 Arteria **13013-30**



3,5 cm, 1.4"

13012-35
13013-35



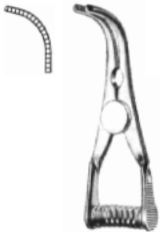
4 cm, 1½"

13012-40
13013-40



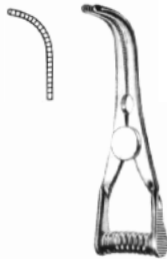
5 cm, 2"

13012-50
13013-50



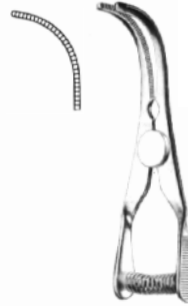
3 cm, 1.2"

Vene **13014-30**
 Arterie **13015-30**



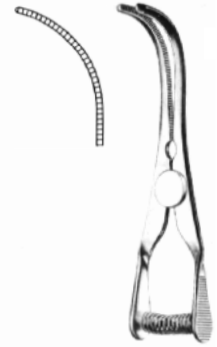
3,5 cm, 1.4"

13014-35
13015-35



4 cm, 1½"

13014-40
13015-40



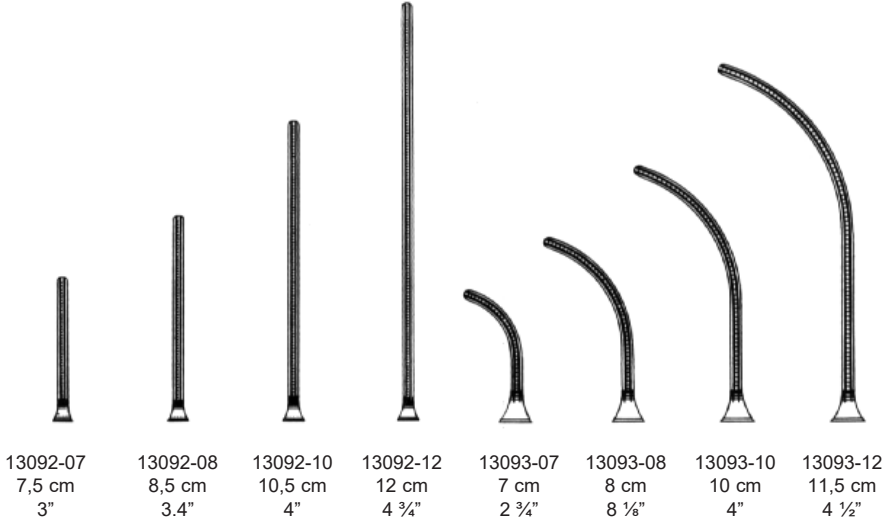
5 cm, 2"

13014-50
13015-50

Atrauma-Bulldogklemmen
 Atrauma Bulldog Clamps
 Clamps Atrauma Bulldog
 Pinze Atrauma Bulldog



DE BAKEY



13092-07
7,5 cm
3"

13092-08
8,5 cm
3.4"

13092-10
10,5 cm
4"

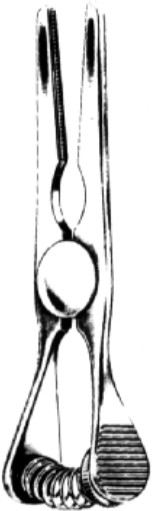
13092-12
12 cm
4 3/4"

13093-07
7 cm
2 3/4"

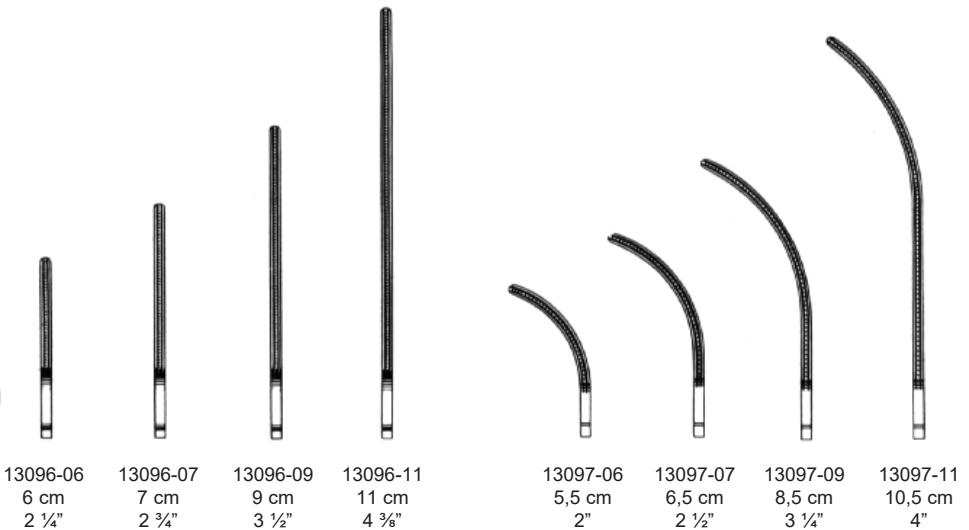
13093-08
8 cm
8 1/8"

13093-10
10 cm
4"

13093-12
11,5 cm
4 1/2"



GLOVER



13096-06
6 cm
2 1/4"

13096-07
7 cm
2 3/4"

13096-09
9 cm
3 1/2"

13096-11
11 cm
4 3/8"

13097-06
5,5 cm
2"

13097-07
6,5 cm
2 1/2"

13097-09
8,5 cm
3 1/4"

13097-11
10,5 cm
4"

Gefäßklemmen, Bulldogklemmen, Arterienklemmen
 Hemostatic Forceps
 Pinzas hemostáticas
 Pinze serraфина, Pinze emostatiche



DIEFFENBACH
 13102-04 3,5 cm, 1.4"
 13102-05 5,5 cm, 2.2"



gerade
 straight
 recta
 rette

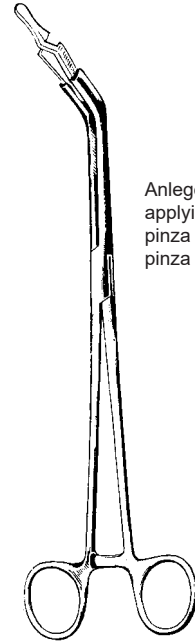
gebogen
 curved
 curva
 curve



DIEFFENBACH
 13103-04 3,5 cm, 1.4"
 13103-05 5,5 cm, 2.2"

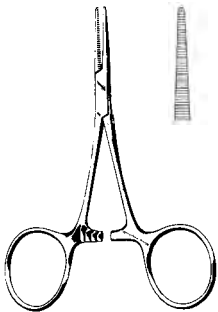
JOHNS-HOPKINS

13110-50	5,0 cm, 2"	13111-50
13110-55	5,5 cm, 2.2"	13111-55
13110-65	6,5 cm, 2.6"	13111-65
13110-70	7,0 cm, 2 3/4"	13111-70
13110-75	7,5 cm, 3"	13111-75
13110-90	9,0 cm, 3 1/2"	13111-90

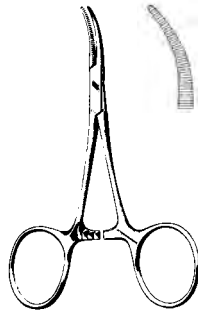


Anlegezange
 applying forceps
 pinza para poner
 pinza applicatrice

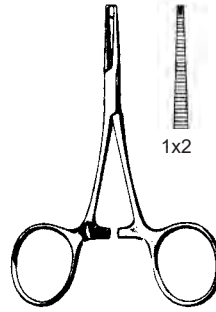
13115-00
 23 cm, 9"



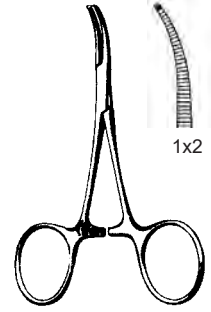
HARTMANN
 13210-10
 10 cm, 4"



HARTMANN
 13211-10
 10 cm, 4"



HARTMANN
 13212-10
 10 cm, 4"



HARTMANN
 13213-10
 10 cm, 4"

Micro-HARTMANN
 13214-10
 10 cm, 4"

Micro-HARTMANN
 13215-10
 10 cm, 4"

Arterienklemmen
Hemostatic Forceps
Pinzas hemostáticas
Pinze emostatiche



TITAN

HALSTED-MOSQUITO

TITAN

13224-12

13220-12	12,5 cm, 5"	13221-12
13220-14	14,0 cm, 5 1/2"	13221-14
13220-18	18,0 cm, 7"	13221-18
13220-21	21,0 cm, 8 1/4"	13221-21

13225-12

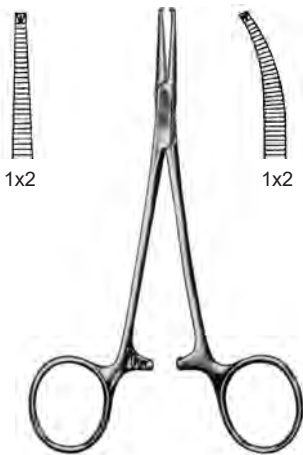


HALSTED-MOSQUITO micro

13222-12 12,5 cm, 5" 13223-12

JACOBSON micro

13226-12 12,5 cm, 5" 13227-12

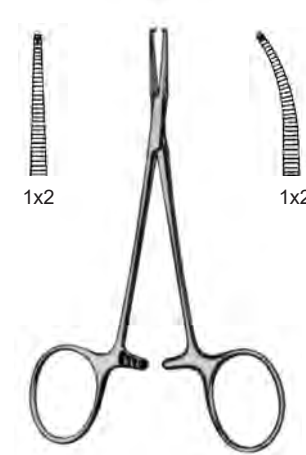


1x2

1x2

HALSTED-MOSQUITO

13230-12	12,5 cm, 5"	13231-12
13230-14	14,0 cm, 5 1/2"	13231-14
13230-18	18,0 cm, 7"	13231-18
13230-21	21,0 cm, 8 1/4"	13231-21



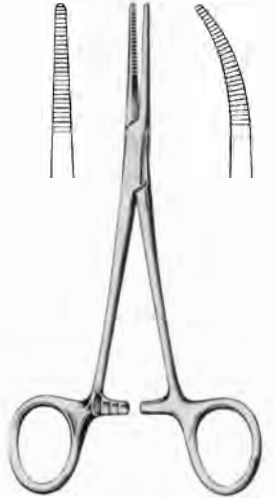
1x2

1x2

HALSTED-MOSQUITO micro

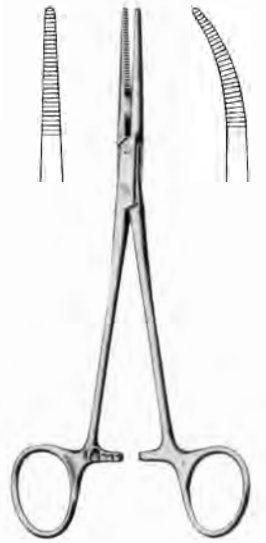
13232-12 12,5 cm, 5" 13233-12

Arterienklemmen
Hemostatic Forceps
Pinzas hemostáticas
Pinze emostatiche



KELLY

13240-14 14 cm, 5 1/2" 13241-14
13240-18 18 cm, 7" 13241-18
13244-14 14 cm, 5 1/2" 13245-14
TITAN TITAN



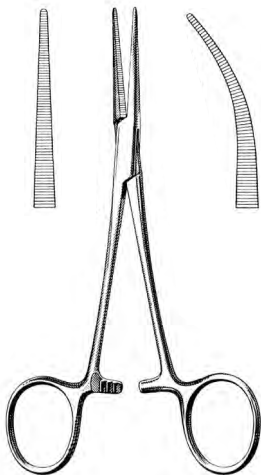
KELLY-RANKIN

13242-16 16 cm, 6 1/4" 13243-16



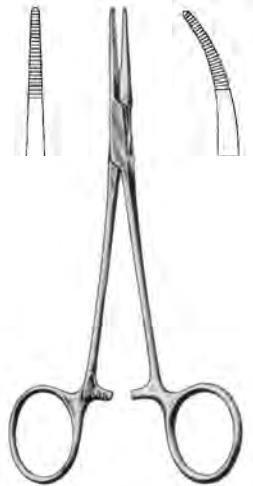
TERRIER

13228-13
13 cm, 5 1/8"



COLLER-CRILE

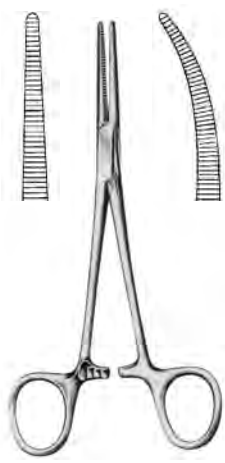
13256-14 14 cm, 5 1/2" 13257-14
13258-16 16 cm, 6 1/4" 13259-16



PROVIDENCE-HOSPITAL

13270-14 14 cm, 5 1/2" 13271-14

Arterienklemmen
Hemostatic Forceps
Pinzas hemostáticas
Pinze emostatiche



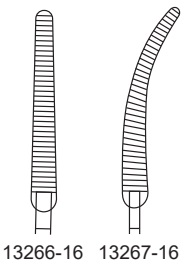
CRILE
13250-14 14 cm, 5 1/2"
13250-18 18 cm, 7"
13254-14 14 cm, 5 1/2"
TITAN



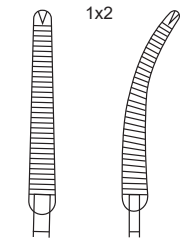
CRILE
13260-14 14 cm, 5 1/2" 13261-14



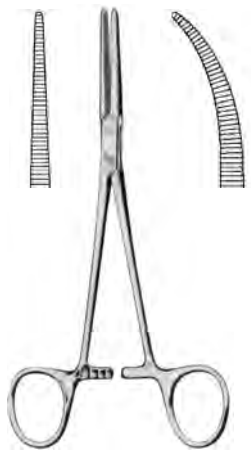
CHRISTOPHE
16 cm, 6 1/4"



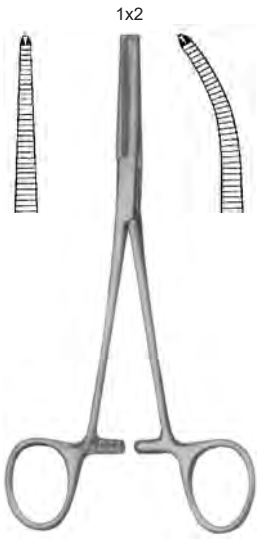
13266-16 13267-16



13268-16 13269-16

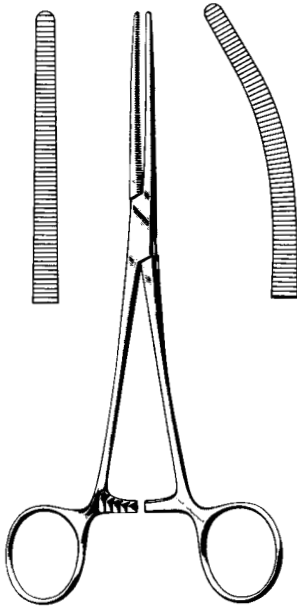


CRILE-RANKIN
13262-16 16 cm, 6 1/4" 13263-16



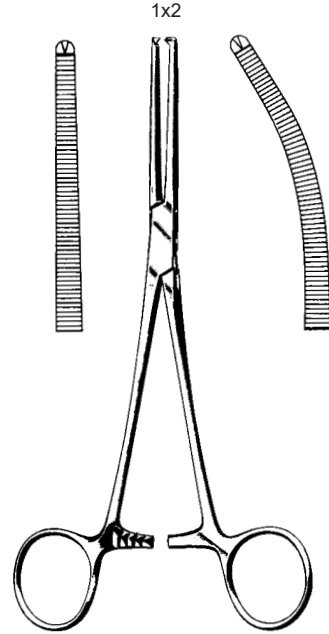
CRILE-RANKIN
13264-16 16 cm, 6 1/4" 13265-16

Arterienklemmen
Hemostatic Forceps
Pinzas hemostáticas
Pinze emostatiche



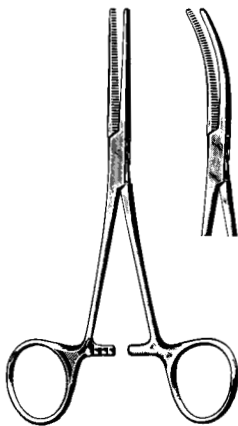
ROCHESTER-PEAN

13310-13	13 cm, 5 1/8"	13311-13
13310-14	14 cm, 5 1/2"	13311-14
13310-16	16 cm, 6 1/4"	13311-16
13310-18	18 cm, 7"	13311-18
13310-20	20 cm, 8"	13311-20
13310-22	22 cm, 8 3/4"	13311-22
13310-24	24 cm, 9 1/2"	13311-24
13310-26	26 cm, 10 1/4"	13311-26
13310-30	30 cm, 11 3/4"	13311-30



ROCHESTER-OCHSNER

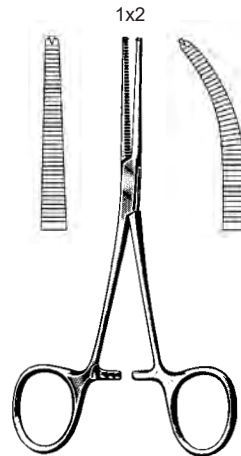
13320-13	13 cm, 5 1/8"	13321-13
13320-14	14 cm, 5 1/2"	13321-14
13320-16	16 cm, 6 1/4"	13321-16
13320-18	18 cm, 7"	13321-18
13320-20	20 cm, 8"	13321-20
13320-22	22 cm, 8 3/4"	13321-22
13320-24	24 cm, 9 1/2"	13321-24
13320-26	26 cm, 10 1/4"	13321-26
13320-30	30 cm, 11 3/4"	13321-30



PEAN

13312-14	14 cm, 5 1/2"	13313-14
13312-16	16 cm, 6 1/4"	13313-16

Fein
Delicate
Delicada
Fina



KOCHER

13322-14	14 cm, 5 1/2"	13323-14
13322-16	16 cm, 6 1/4"	13323-16

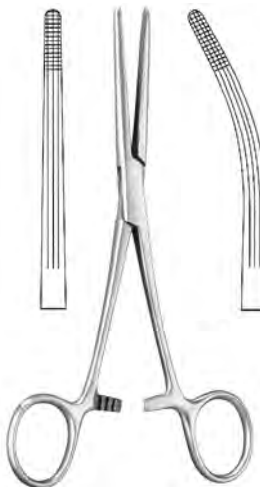
Fein
Delicate
Delicada
Fina

Arterienklemmen
Hemostatic Forceps
Pinzas hemostáticas
Pinze emostatiche



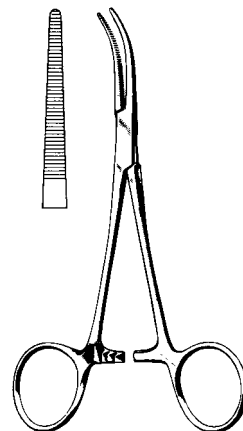
SPENCER-WELLS

13330-13	13 cm, 5"	13331-13
13330-15	15 cm, 6"	13331-15
13330-18	18 cm, 7"	13331-18
13330-20	20 cm, 8"	13331-20
13330-23	23 cm, 9"	13331-23



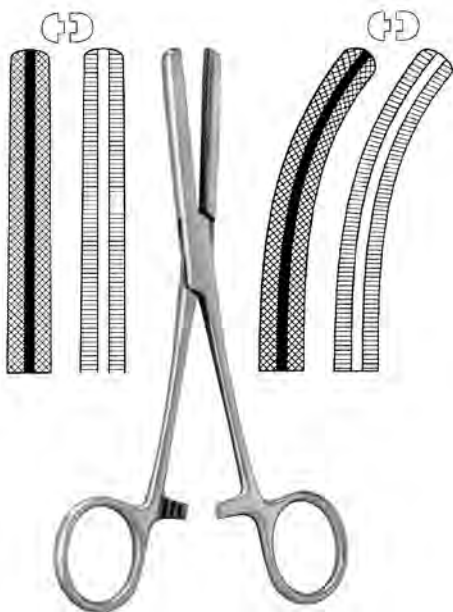
ROCHESTER-CARMALT

13340-16	16 cm, 6 1/4"	13341-16
13340-20	20 cm, 8"	13341-20



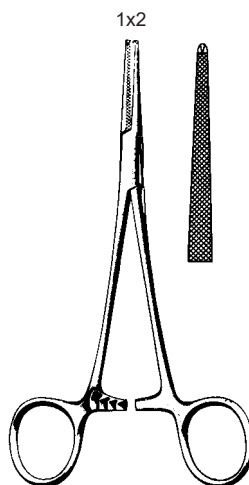
DANDY

13345-12	12 cm, 4 3/4"
13345-14	14 cm, 5 1/2"



FERGUSSON

13350-16	16 cm, 6 1/4"	13351-16
13350-20	20 cm, 8"	13351-20



LOVELACE

13356-15	15,5 cm, 6"
----------	-------------



PENNINGTON

13358-15	15,5 cm, 6"
13358-20	20,0 cm, 8"

Fasszangen
Grasping Forceps
Pinza para agarrar órganos y tejidos
Pinze da presa



PRATT
13360-15 15 cm, 6"



MARTEL
13364-14 14 cm, 5 1/2"



WILLET MARTEL
13366-19 19 cm, 7 1/2"



PEAN
13368-14 14 cm, 5 1/2"
13368-16 16 cm, 6 1/4"



CHAPUT
13370-13
13 cm, 5 1/8"



TUFFIER
13372-13
13 cm, 5 1/8"



COLLIN
13374-14
14 cm, 5 1/2"

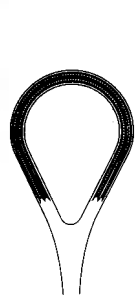


COLLIN
13376-16
16 cm, 6 1/4"

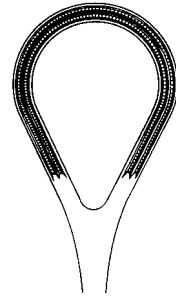
Organ- und Gewebefasszange, Arterienklemmen
 Organ- and Tissue Grasping Forceps, Hemostatic Forceps
 Pinza para agarrar órganos y tejidos, Pinzas hemostáticas
 Pinza per tessuti e organi, Pinze emostatiche



REDA
 Atrauma
 13377-25 - 13377-26



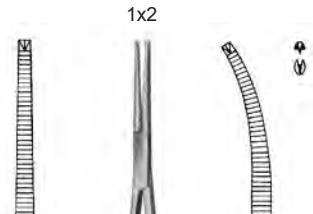
13377-25
 25 cm, 10"



13377-26
 26 cm, 10 1/4"

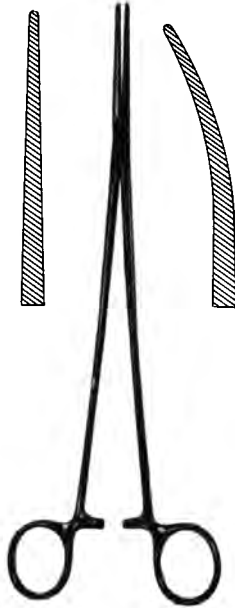


LERICHE
 13380-15 15 cm, 6" 13381-15



LERICHE
 13382-15 15 cm, 6" 13383-15

Arterienklemmen
 Hemostatic Forceps
 Pinzas hemostáticas
 Pinze emostatiche



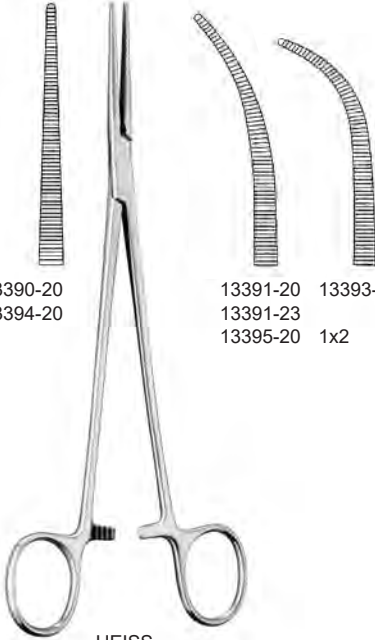
BENGOLEA

- 13384-20 20 cm, 8" 13385-20
- 13384-24 24 cm, 9 1/2" 13385-24
- 13384-26 26 cm, 10 1/4" 13385-26



BENGOLEA

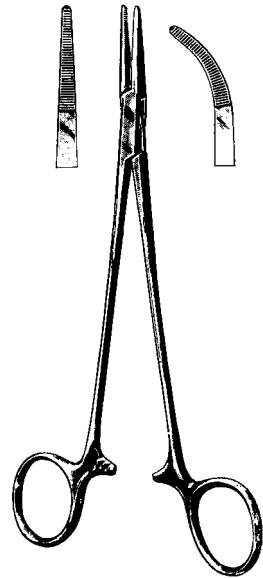
- 13386-20 20 cm, 8" 13387-20
- 13386-24 24 cm, 9 1/2" 13387-24
- 13386-26 26 cm, 10 1/4" 13387-26



HEISS
 20 cm, 8"

- 13390-20
- 1x2 13394-20

- 13391-20 13393-20
- 13391-23
- 13395-20 1x2

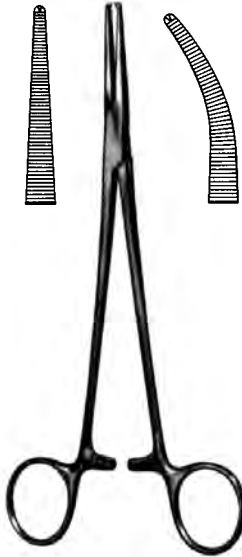


ADSON

- 13410-18 18,5 cm, 7 1/4" 13411-18

Arterienklemmen
Hemostatic Forceps
Pinzas hemostáticas
Pinze emostatiche

1x2



ADSON
13412-18 18,5 cm, 7 1/4" 13413-18



FUCHSIG
13414-20 19 cm, 7 1/2"



ADSON BABY
13415-14 14,0 cm, 5 1/2"
13415-18 18,5 cm, 7 1/4"



NISSEN
13416-18 18,5 cm, 7 1/4"

Arterienklemmen
 Hemostatic Forceps
 Pinzas hemostáticas
 Pinze emostatiche



OVERHOLT-BABY
 13420-14
 14 cm, 5 1/2"



OVERHOLT-GEISSENDOERFER
 21 cm, 8 1/4"

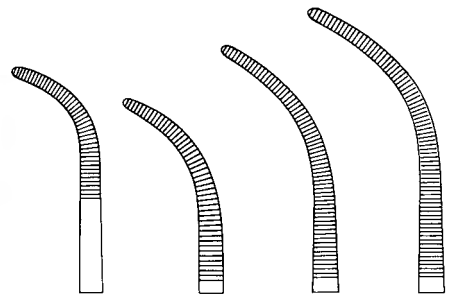


Fig. 1
 13421-01

Fig. 2
 13421-02

Fig. 3
 13421-03

Fig. 4
 13421-04

13425-02
 26 cm
 10 1/4"

13425-03
 27 cm
 10 1/2"

13425-04
 27,5 cm
 10,8"

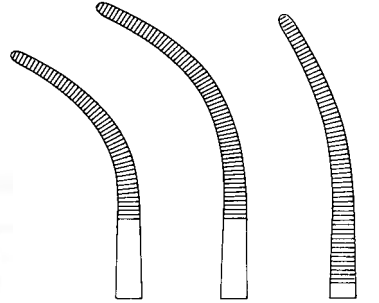


Fig. 5
 13421-05

Fig. 6
 13421-06

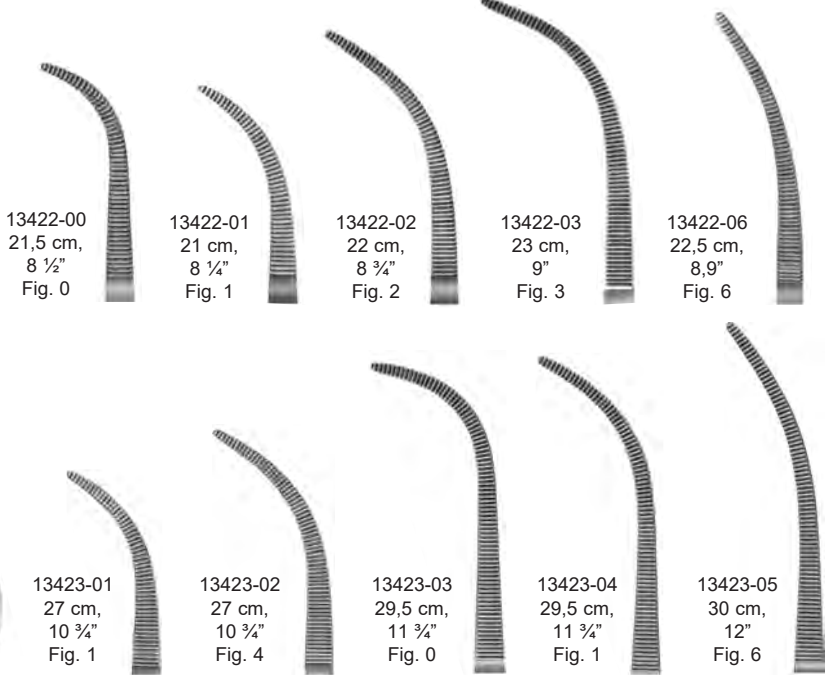
Fig. 7
 13421-07

13425-05
 27 cm
 10 1/2"

13425-06
 28 cm
 11"



OVERHOLT



13422-00
 21,5 cm,
 8 1/2"
 Fig. 0

13422-01
 21 cm,
 8 1/4"
 Fig. 1

13422-02
 22 cm,
 8 3/4"
 Fig. 2

13422-03
 23 cm,
 9"
 Fig. 3

13422-06
 22,5 cm,
 8,9"
 Fig. 6

13423-01
 27 cm,
 10 3/4"
 Fig. 1

13423-02
 27 cm,
 10 3/4"
 Fig. 4

13423-03
 29,5 cm,
 11 3/4"
 Fig. 0

13423-04
 29,5 cm,
 11 3/4"
 Fig. 1

13423-05
 30 cm,
 12"
 Fig. 6

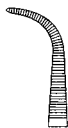
Arterienklemmen
Hemostatic Forceps
Pinzas hemostáticas
Pinze emostatiche



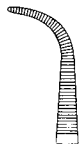
OVERHOLT-MIXTER
13428-21
21,5 cm, 8 ½"



GEMINI



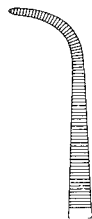
13431-13
13 cm
5 ¼"



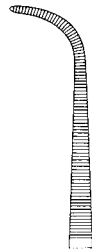
13431-16
16 cm
6 ¼"



13431-18
18 cm
7"



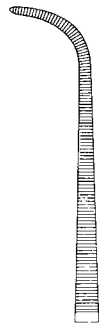
13431-20
20 cm
8"



13431-23
23 cm
9"

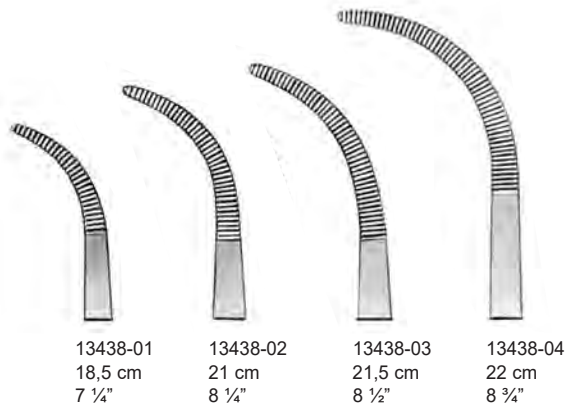


13431-25
25 cm
10"



13431-28
28 cm
11"

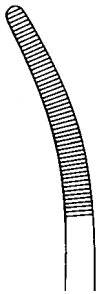
Arterienklemmen
Hemostatic Forceps
Pinzas hemostáticas
Pinze emostatiche



Arterienklemmen
Hemostatic Forceps
Pinzas hemostáticas
Pinze emostatiche



RUMEL
23 cm, 9"



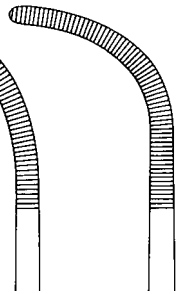
13441-01



13441-02



13441-03



13441-04



WIKSTROEM
13447-20
20,5 cm, 8"



13442-21 21 cm, 8 1/4"
13442-26 26 cm, 10 1/4"

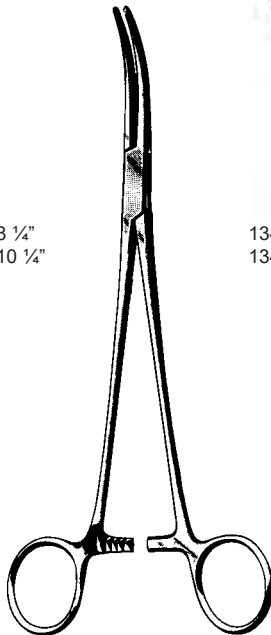


13443-21 21 cm, 8 1/4"
13443-26 26 cm, 10 1/4"



1x2

13444-21 21 cm, 8 1/4"
13444-26 26 cm, 10 1/4"

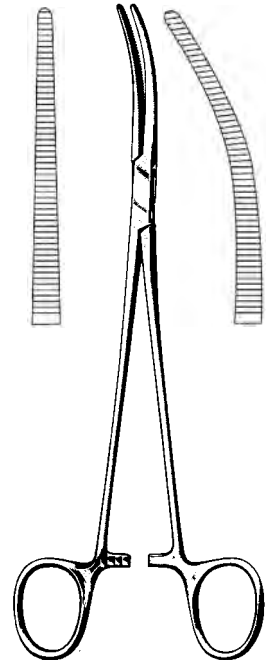


TOENNIS



1x2

13445-21 21 cm, 8 1/4"
13445-26 26 cm, 10 1/4"

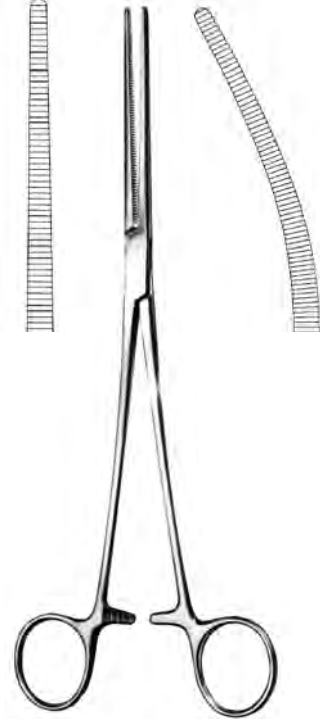


ROBERTS
13448-22 22 cm, 8 3/4" 13449-22

Arterienklemmen
 Hemostatic Forceps
 Pinzas hemostáticas
 Pinze emostatiche



CRAFOORD
 13453-18 18 cm, 7"
 13453-24 24 cm, 9 ½"



SAROT
 13450-24 24 cm, 9 ½" 13451-24



13455-01

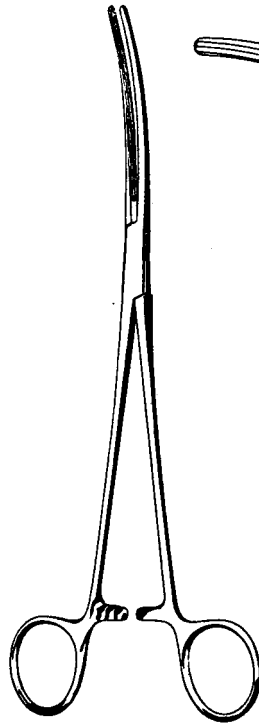


ZENKER
 29,5 cm, 11 ½"

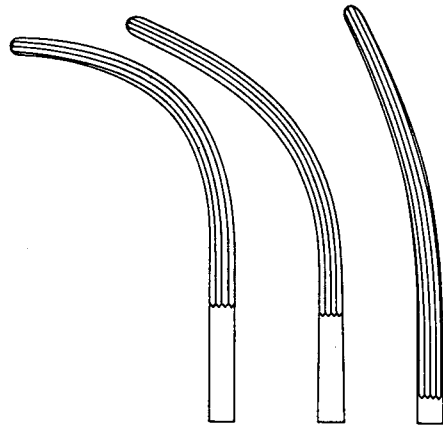


13455-02

Arterienklemmen
Hemostatic Forceps
Pinzas hemostáticas
Pinze emostatiche



CRAFOORD-SELLORS
24 cm, 9 ½"



13456-01

13456-02

13456-03

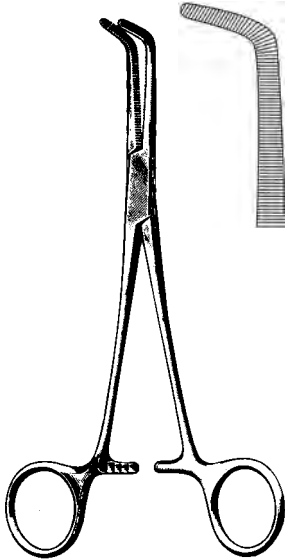


LAWRENCE
13457-28 28 cm, 11"

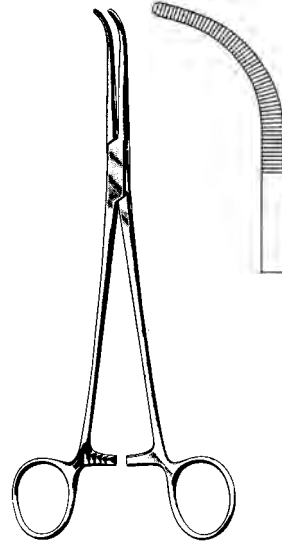


MEEKER
13459-18 18 cm, 7"
13459-28 28 cm, 11"

Arterienklemmen
Hemostatic Forceps
Pinzas hemostáticas
Pinze emostatiche



MIXTER
13471-14 14 cm, 5 ½"
13471-16 16 cm, 6 ¼"
13471-18 18 cm, 7"
13471-23 23 cm, 9"



MIXTER
13473-22
22 cm, 8 ¾"



KANTROWITZ
13474-19 19 cm, 7 ½"
13474-24 24 cm, 9 ½"
13474-26 26 cm, 10 ¼"

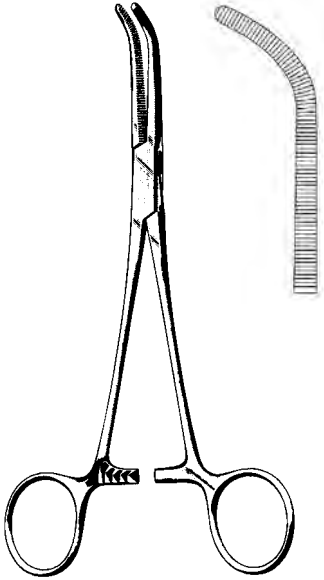


MIXTER BABY
13475-14
14 cm, 5 ½"

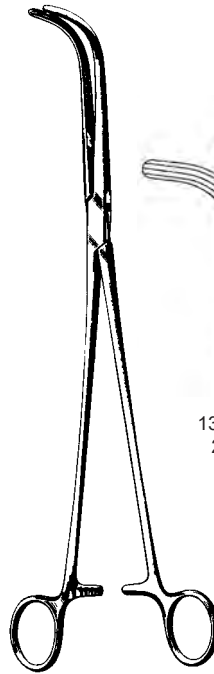


MIXTER BABY
13475-18
18 cm, 7"

Arterienklemmen
Hemostatic Forceps
Pinzas hemostáticas
Pinze emostatiche



MIXTER-O'SHAUGHNESSY
13477-15 15,5 cm, 6"
13477-19 19,0 cm, 7 ½"

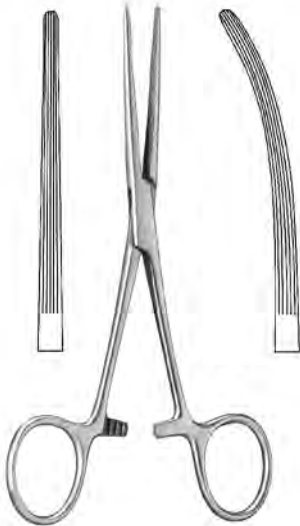


13479-22
22 cm
8 ¾"

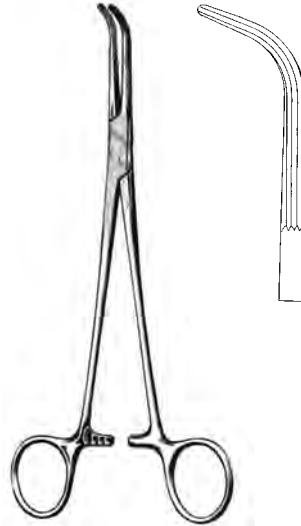
13479-25
25 cm
10"

13479-28
28 cm
11"

MIXTER

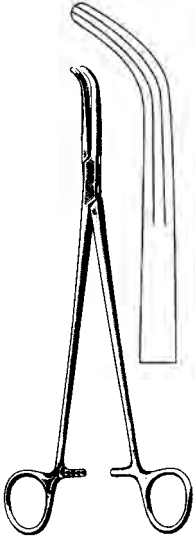


BAINBRIDGE
13480-15 15,0 cm, 6" 13481-15
13480-18 18,5 cm, 7 ¼" 13481-18

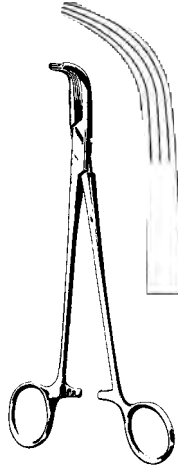


LAHEY
13491-19 19 cm, 7 ½"

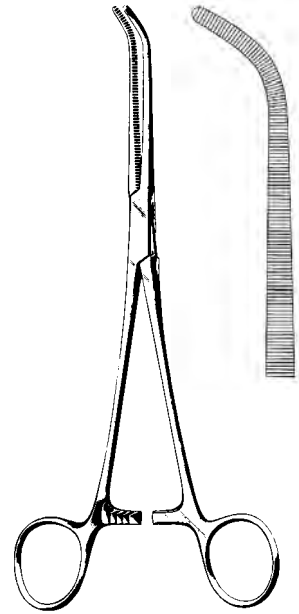
Arterienklemmen
Hemostatic Forceps
Pinzas hemostáticas
Pinze emostatiche



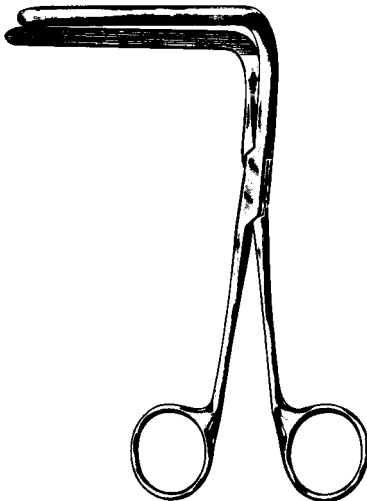
LAHEY
13493-23 23 cm, 9"



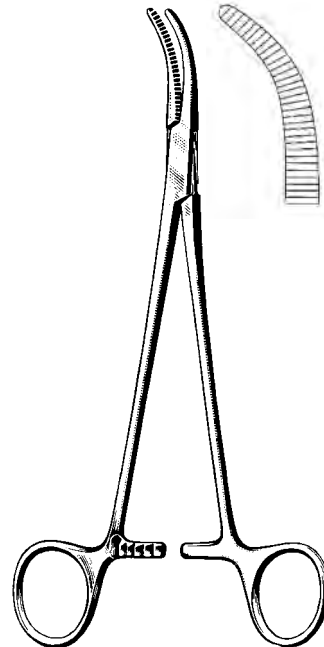
LOWER
13495-18 18 cm, 7"



JOHNS-HOPKINS
13497-20 20 cm, 8"



MIXTER
13499-16
16,5 cm, 6 1/2"

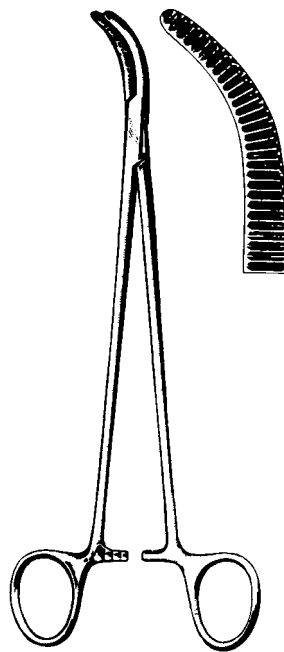


MOYNIHAN
13501-23
23 cm, 9"

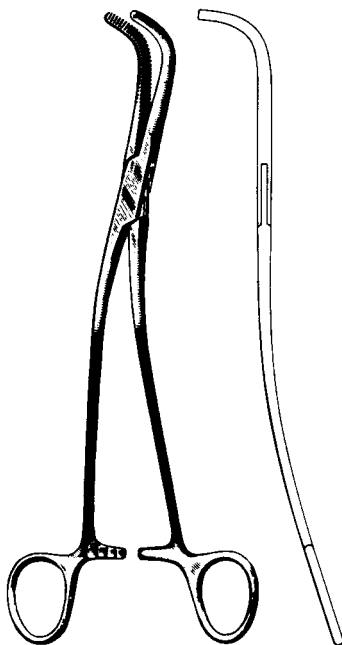
Arterienklemmen
Hemostatic Forceps
Pinzas hemostáticas
Pinze emostatiche



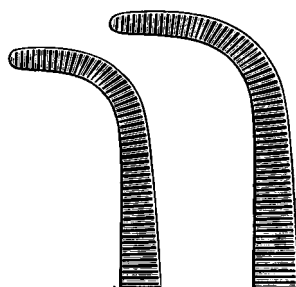
DESJARDINS
13503-21 21 cm, 8 1/4"



DESJARDINS
13505-21 21 cm, 8 1/4"



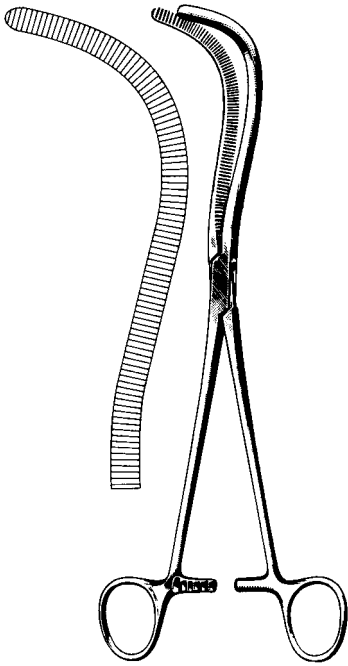
GRAY



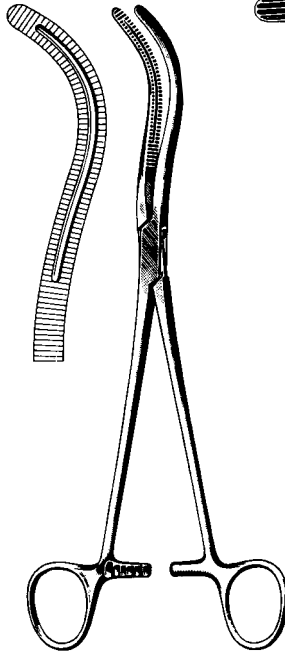
13507-22
22 cm
8 3/4"

13507-23
23 cm
9"

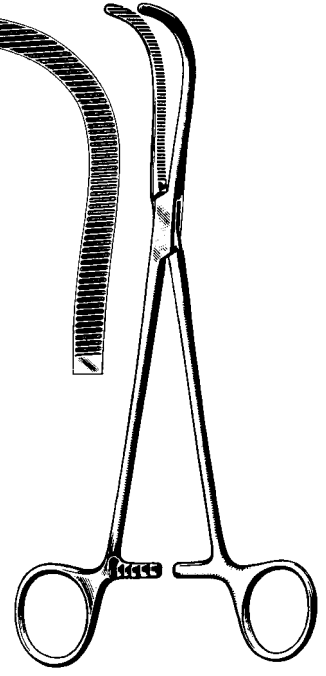
Arterienklemmen
Hemostatic Forceps
Pinzas hemostáticas
Pinze emostatiche



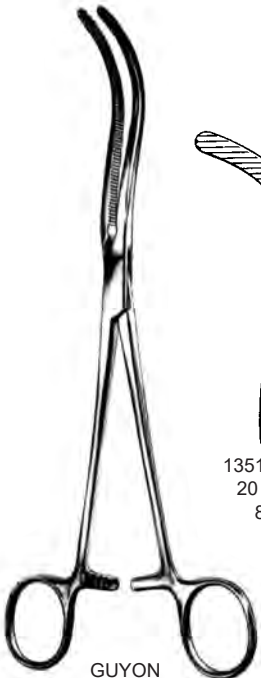
MAYO-GUYON
13513-23
23 cm, 9"



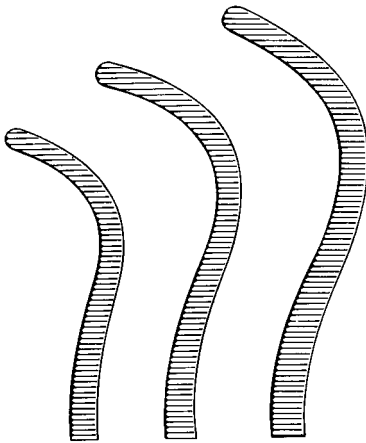
STILLE
13515-23
23 cm, 9"



GUYON
13517-23
23 cm, 9"



GUYON



13519-20
20 cm
8"

13519-22
22 cm
8 3/4"

13519-24
24 cm
9 1/2"



GUYON

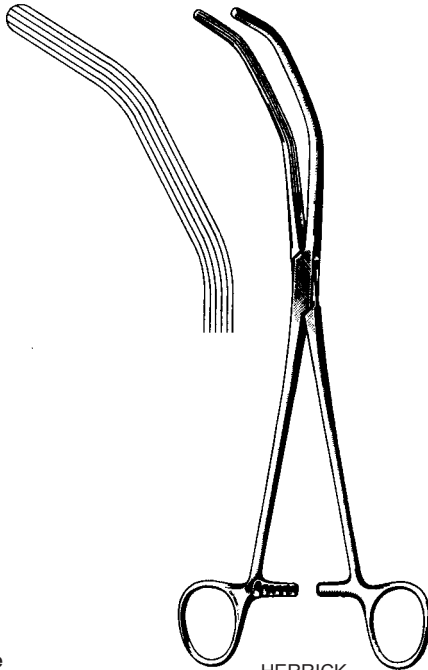


13520-24
24 cm
9 1/2"

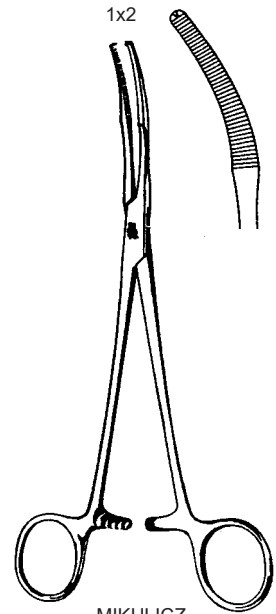
13520-23
23 cm
9"

ATRAUMA

Hysterektomieklemmen
Hysterectomy Forceps
Pinzas para histerectomía
Pinze per isterectomia

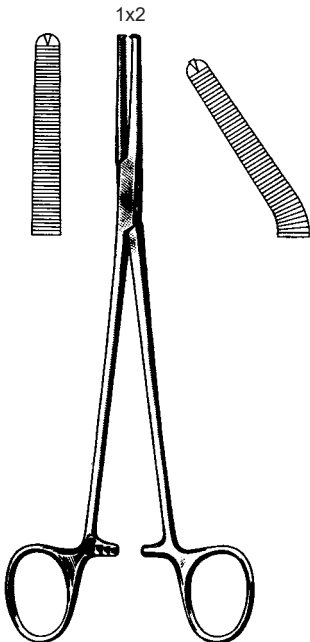


HERRICK
13523-23
23 cm, 9"



MIKULICZ
13551-14 14 cm, 5 1/2" BABY
13551-18 18 cm, 7"
13551-20 20 cm, 8"

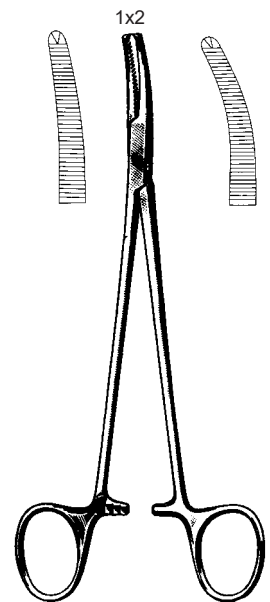
Peritoneum-Klemme
Peritoneum Forceps
Pinzas para peritoneo
Pinze peritoneali



PHANEUF
13554-21 21 cm, 8 1/2" 13555-21



MIKULICZ
13556-24 24 cm, 9 1/2"



FAURE
13561-20 20 cm, 8" 13563-20

Hysterektomieklemmen
Hysterectomy Forceps
Pinzas para histerectomía
Pinze per isterectomia



MAINGOT
13564-20 20 cm, 8"

Hysterektomieklemmen
Hysterectomy Forceps
Pinzas para histerectomía
Pinze per isterectomia



13565-20
20,5 cm, 8"

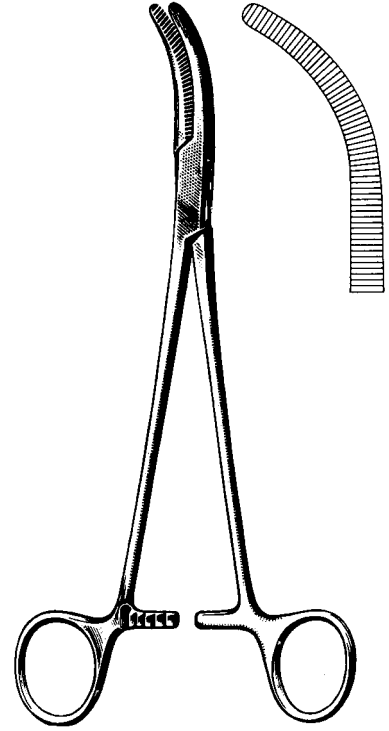
13565-25
25 cm, 10"

MAINGOT

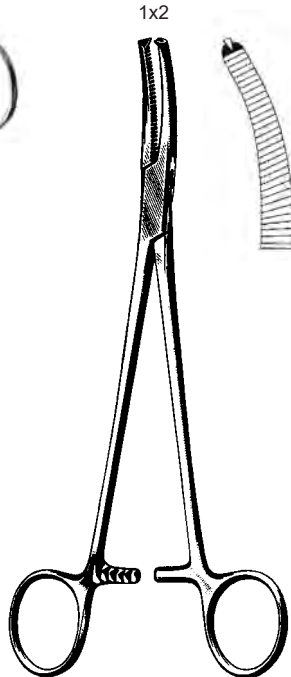
Hysterektomieklemmen
 Hysterectomy Forceps
 Pinzas para histerectomía
 Pinze per isterectomia



WERTHEIM
 13570-23
 23,5 cm, 9 ¼"



WERTHEIM
 13571-25
 25 cm, 10"



WERTHEIM
 13573-22 22 cm, 8 ¾"

Hysterektomieklemmen
 Hysterectomy Forceps
 Pinzas para histerectomía
 Pinze per isterectomia



SEGOND-LANDAU
 13574-24
 24 cm, 9 ½"

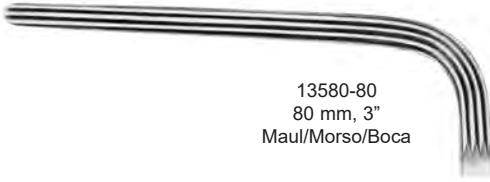


SEGOND
 13575-24
 24 cm, 9 ½"



WERTHEIM-CULLEN
 13579-21 21,5 cm, 8 ½"

Hysterektomieklemmen
 Hysterectomy Forceps
 Pinzas para histerectomía
 Pinze per isterectomia



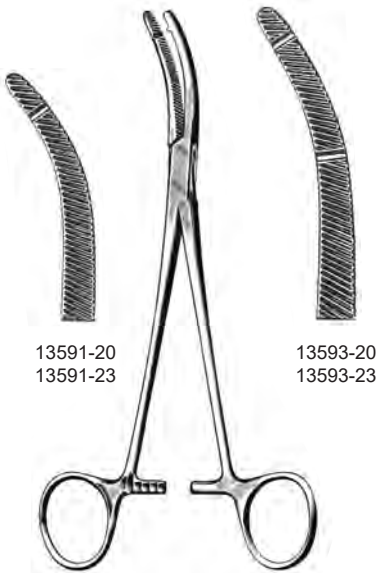
13580-80
 80 mm, 3"
 Maul/Morso/Boca



13580-60
 60 mm, 2 1/4"
 Maul/Morso/Boca



23 cm, 9"



13591-20
 13591-23

13593-20
 13593-23

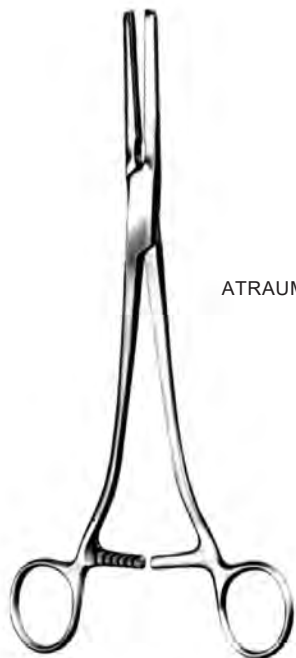
HEANEY
 20 cm, 8"



1x2

HOLZBACH
 13598-24 24 cm, 9 1/2" 13599-24

Hysterektomieklemmen
Hysterectomy Forceps
Pinzas para histerectomía
Pinze per isterectomia



ATRAUMA

ROGERS
13595-10 - 13597-40



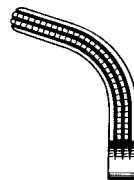
22 cm
8 3/4"
13595-10



21,5 cm
8 1/2"
13595-20



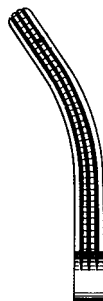
21 cm
8 1/4"
13595-30



20,5 cm
8"
13595-40



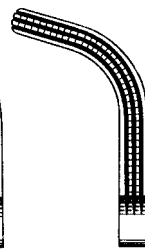
25 cm
10"
13597-10



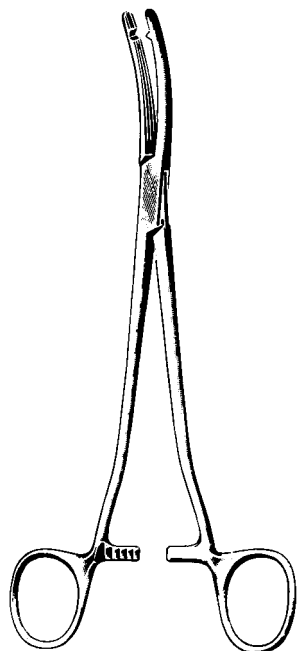
25 cm
10"
13597-20



24,5 cm
9 3/4"
13597-30



23 cm
9"
13597-40



HEANY-BALLENTINE
13600-20 - 13601-20
20 cm, 8"



BALLENTINE
13600-20



HEANY-BALLENTINE
13601-20

Hysterektomieklemmen
Hysterectomy Forceps
Pinzas para histerectomía
Pinze per isterectomia



WERTHEIM
13605-26
25,5 cm, 10"

Parametriumklemmen
Parametrium Clamps
Pinza para parametrio
Pinza per parametrio



REDA
21 cm 8 1/4"



13610-21



13611-21



13612-21

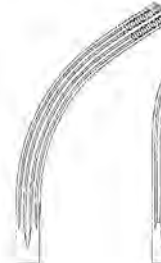
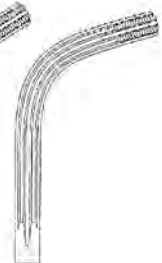


13613-21



REDA

24 cm, 9 1/2"
26 cm, 10 1/4"
30 cm, 12"

13620-24
13620-26
13620-3013621-24
13621-26
13621-3013622-24
13622-26
13622-3013623-24
13623-26
13623-30

Präparier- und Ligaturklemmen
Dissecting and Ligature Forceps
Pinzas para preparaciones y para ligaduras
Pinze per preparazione e per legatura



13640-28
28 cm, 11"

Schlauchklemmen
Tubing Clamps
Pinzas cierra-tubos
Pinze serratubi



KLINIKUM BERLIN
13702-14
14,5 cm, 5 3/4"



13710-15
15 cm, 6"



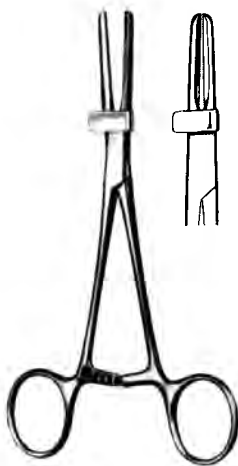
13710-19
19 cm, 7 1/4"



13710-20
20 cm, 8"



PRESBYTERIAN
13704-16 16 cm, 6 1/4"
13704-18 18 cm, 7"



13712-15
15 cm, 6"



13712-18
18 cm, 7"

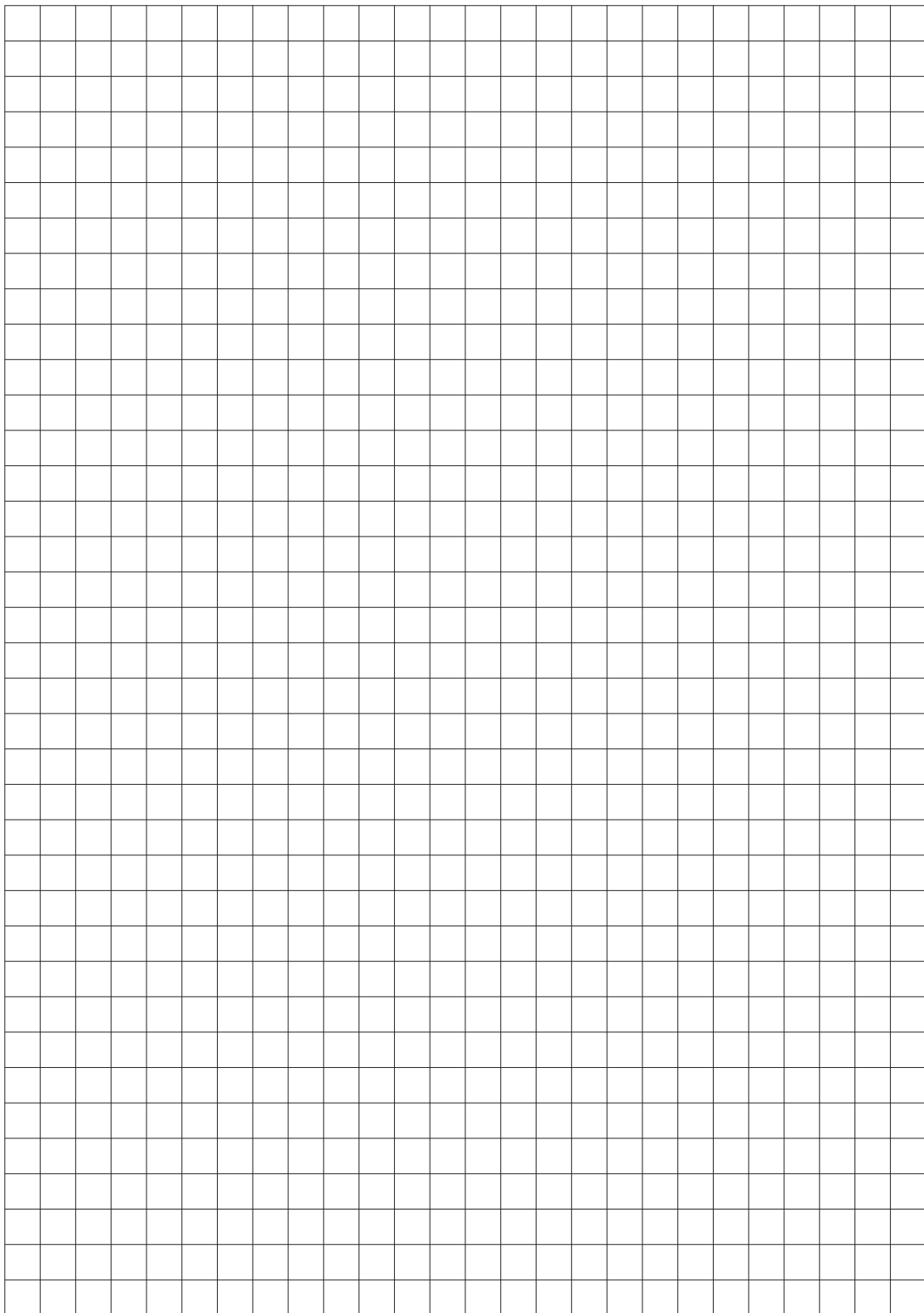


13712-20
20 cm, 8"

Rollenklemme
Tube milking rollers
Pinza de rodillos
Pinze con rotelle



BÜLOW-GUNAR-HEY
13720-18
18 cm, 7"



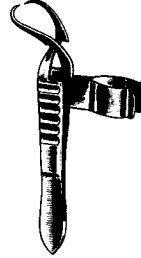
Tuchklemmen
Towel Forceps
Pinzas de campos
Pinze fissateli



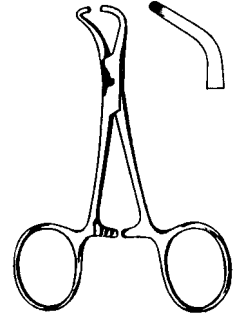
SCHAEDEL
15101-09
9 cm, 3 ½"



JONES
15103-07
7 cm, 2 ¾"



JONES-CLIP
15105-09
9 cm, 3 ½"

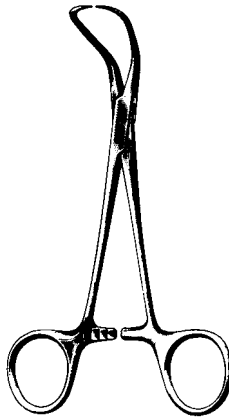


TOHUKU
15107-10 10 cm, 4"
15107-13 13 cm, 5 ½"

15103-09
9 cm, 3 ¾"



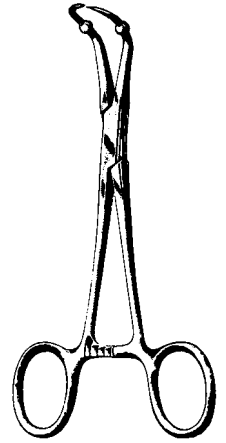
PEERS
15108-14
14,5 cm, 5 ¾"



BACKHAUS
15111-09 9 cm, 3 ½"
15111-11 11 cm, 4 ¾"
15111-13 13 cm, 5 ⅛"
15111-15 15 cm, 6"



BACKHAUS-CLIP
15115-11
11 cm, 4 ¾"



ROEDER
15117-13
13 cm, 5 ⅛"

Tuchklemmen
Towel Forceps
Pinzas de campos
Pinze fissateli



LORNA

15121-11 11 cm, 4 $\frac{3}{8}$ "
15121-13 13 cm, 5 $\frac{1}{8}$ "



BALL AND SOCKET

15123-11 11 cm, 4 $\frac{3}{8}$ "
15123-13 13 cm, 5 $\frac{1}{8}$ "

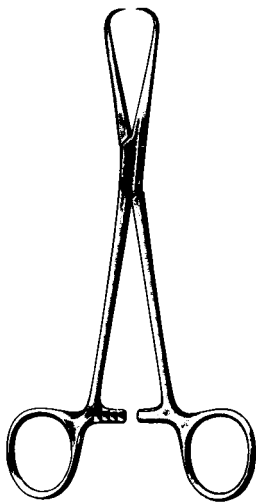


OMBREDANNE (JACKSON)

15124-13
13,5 cm, 5 $\frac{3}{8}$ "



15125-14
14,5 cm, 5 $\frac{3}{8}$ "



BERNHARD
15140-16
16,5 cm, 6 $\frac{1}{2}$ "

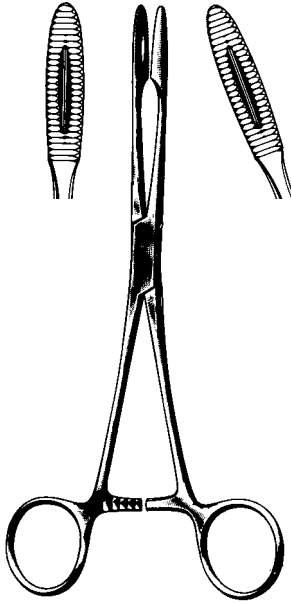


DOYEN
15161-18
18 cm, 7"



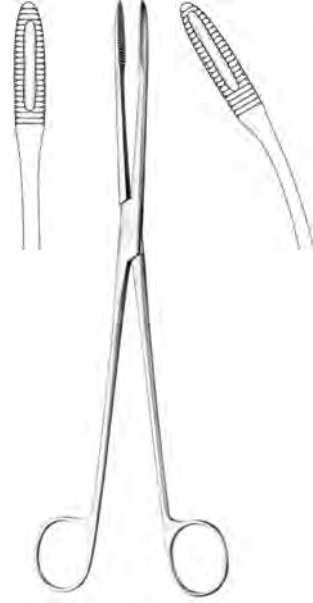
LANE
15164-15 15 cm, 6"
15164-20 20 cm, 8"

Tupfer- und Kornzangen
 Dressing Forceps
 Pinzas para tampones y curaciones
 Pinze per tamponi e per medicazione



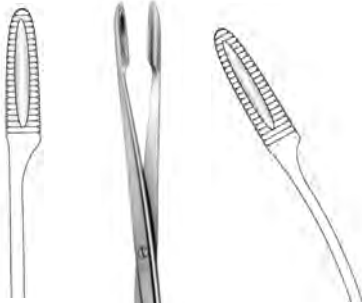
GROSS-MAIER

17110-20	20 cm, 8"	17111-20
17110-25	25 cm, 10"	17111-25
17110-27	27 cm, 10 3/4"	17111-27



GROSS-MAIER

17112-20	20 cm, 8"	17113-20
17112-25	25 cm, 10"	17113-25



17120-28

17121-28

SIMS-MAIER
28 cm, 11"

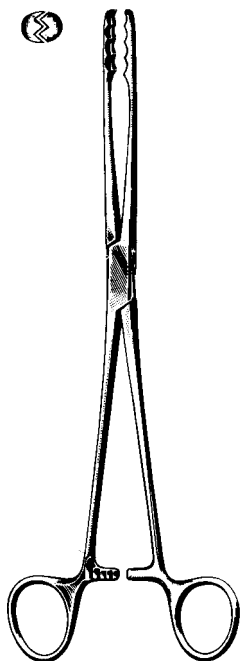
DUPLAY

17131-21 21 cm, 8 1/4"

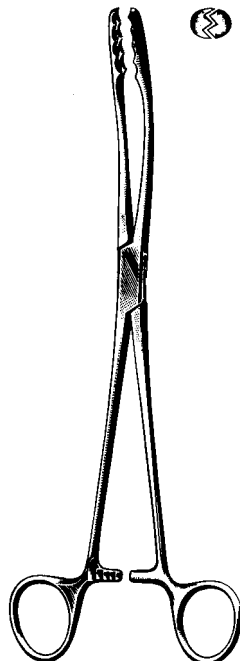
Tupfer- und Kornzangen
 Dressing Forceps
 Pinzas para tampones y curaciones
 Pinze per tamponi e per medicazione



17133-17 17 cm, 6 ¾"

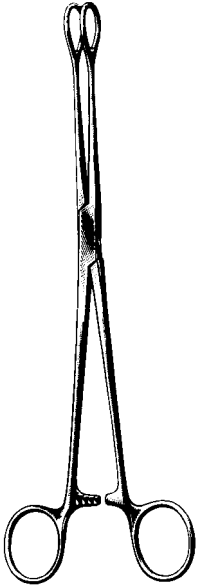


ULRICH
 17160-22 22 cm, 8 ¾"
 17160-25 25 cm, 10"

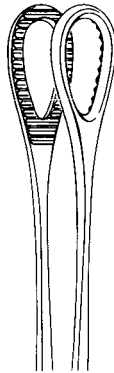


ULRICH
 17161-22 22 cm, 8 ¾"
 17161-25 25 cm, 10"

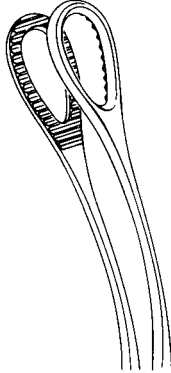
Schwammzange
 Sponge Forceps
 Pinzas porta-esponjas
 Pinze per spugne



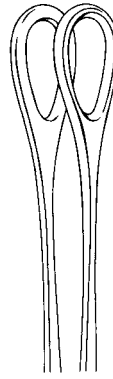
FOERSTER



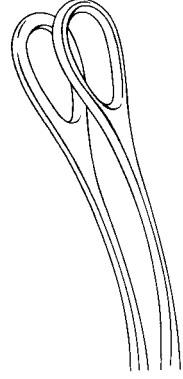
17170-18
 17170-20
 17170-25
 17170-30



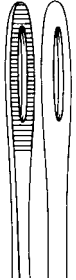
17171-18 18 cm, 7"
 17171-20 20 cm, 8"
 17171-25 25 cm, 10"



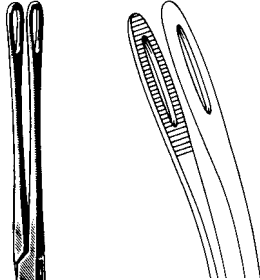
17172-18
 17172-25



17173-18
 17173-25



17174-25



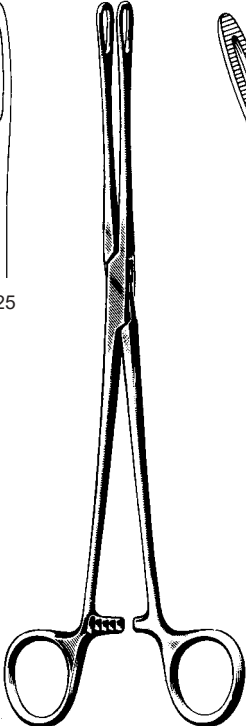
17175-25



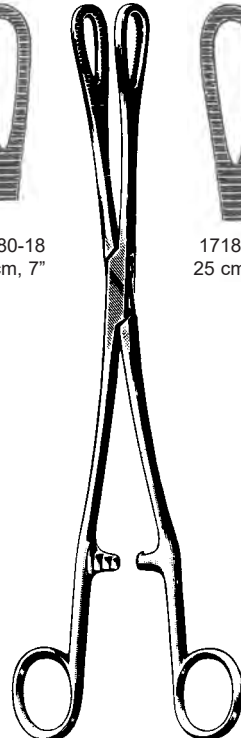
17180-18
 18 cm, 7"



17180-25
 25 cm, 10"

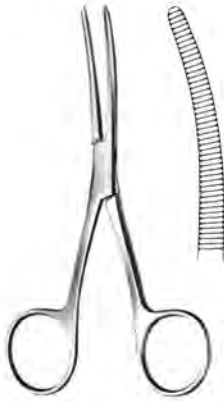


FOERSTER
 25 cm, 10"



RAMPLEY

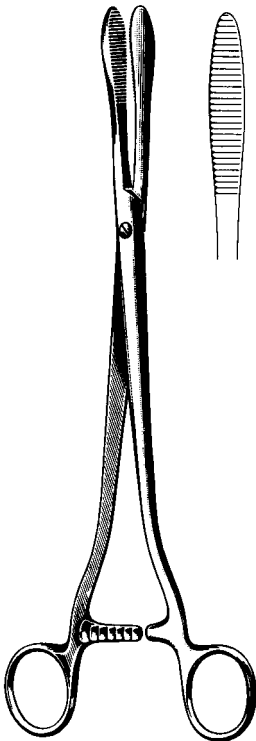
Kornzangen, Sinusklemmen
Dressing Forceps, Sinus Forceps
Pinzas para vendajes
Pinze per medicature, Pinze per seni



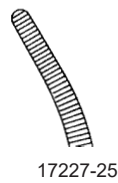
BRYANT
17207-13 13 cm, 5 1/8"



LISTER (Sinus)
17210-13 13 cm, 5 1/8"
17210-16 16 cm, 6 1/4"
17210-18 18 cm, 7"



COLLIN
17220-25 25 cm, 10"

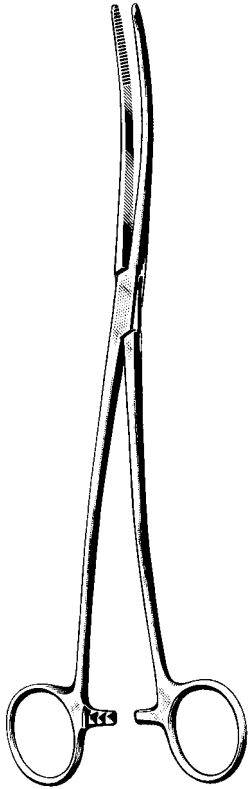


PELKMANN
25 cm, 10"

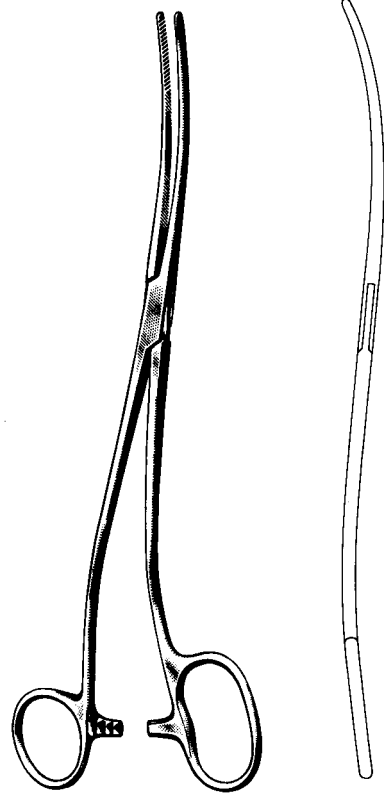


CHERON
17229-25 25 cm, 10"

Tamponzangen
Dressing Forceps
Pinzas para tapones
Pinze per tamponi



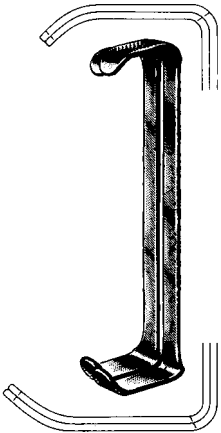
— BOZEMANN —
17230-26 17231-26
26 cm, 10 1/4"



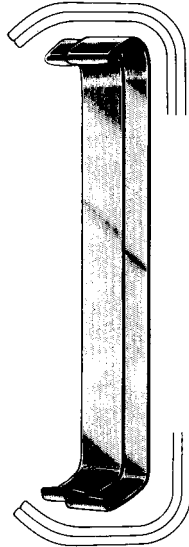
BOZEMANN-DOUGLAS
17233-26
26 cm, 10 1/4"

Wundhaken
Retractors
Separadores
Divaricatori

Satz, set, juego, serie



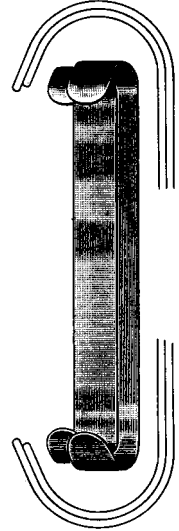
FARABEUF
19102-12
12 cm, 4 3/4"



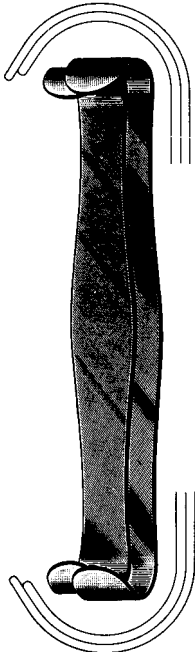
FARABEUF
19102-15
15 cm, 6"



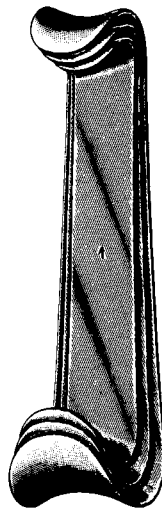
COLLIN
19104-15
15 cm, 6"



PARKER
19110-13
13,5 cm, 5 1/4"



PARKER
19110-18 18 cm, 7"



ROUX
19120-00

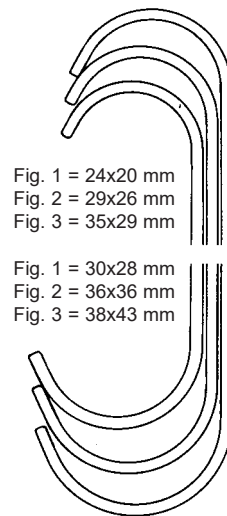


Fig. 1 = 24x20 mm
Fig. 2 = 29x26 mm
Fig. 3 = 35x29 mm

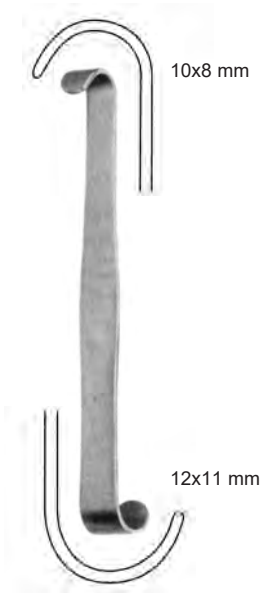
Fig. 1 = 30x28 mm
Fig. 2 = 36x36 mm
Fig. 3 = 38x43 mm

19120-14 Fig. 1 14 cm, 5 1/2"
19120-15 Fig. 2 15 cm, 6"
19120-17 Fig. 3 17 cm, 6 3/4"

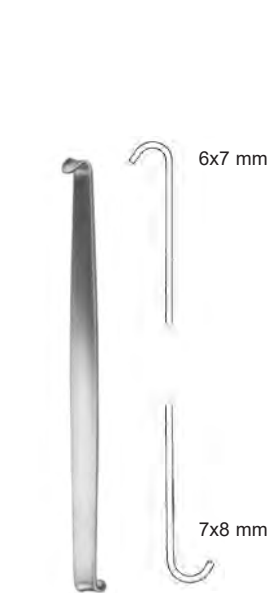
Wundhaken
Retractors
Separadores
Divaricatori



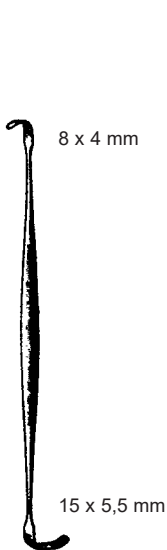
ROUX BABY
19122-13
13 cm, 5 1/8"



LUER
19123-11
11 cm, 4 3/8"



ROUX mini
19124-15
14 cm, 5 1/2"



RAGNELL
19125-14
14 cm, 5 1/2"



ROSE
19126-13
13 cm, 5 1/8"



CRILE
19127-11
11,5 cm, 4 1/2"

Wundhaken
Retractors
Separadores
Divaricatori

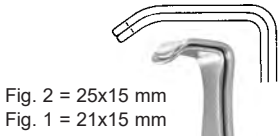


Fig. 2 = 25x15 mm
Fig. 1 = 21x15 mm

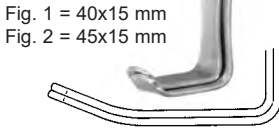
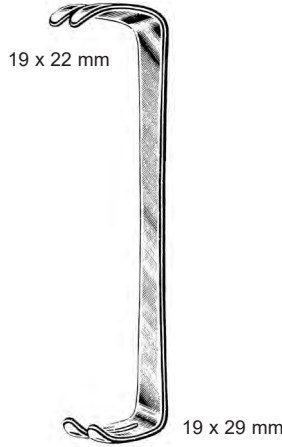


Fig. 1 = 40x15 mm
Fig. 2 = 45x15 mm

US ARMY / PARKER-LANGENBECK
19131-21 21 cm, 8 1/4"



19 x 22 mm

19 x 29 mm

MAYO-COLLINS
19132-15 15 cm, 6"



Fig. 2 = 47 x 13 mm
Fig. 1 = 42 x 13 mm

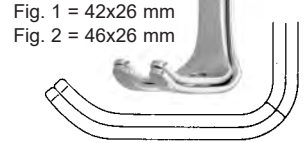


Fig. 1 = 42x26 mm
Fig. 2 = 46x26 mm

MATHIEU
19134-20 20 cm, 8"



37x40 mm

30 x 31 mm

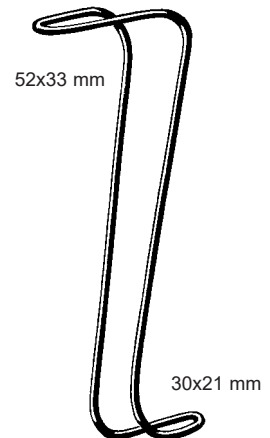
GOELET
19135-19 19 cm, 7 1/2"



38 x 22 mm

38 x 22 mm

CZERNY
19136-20 17,5 cm, 6,9"

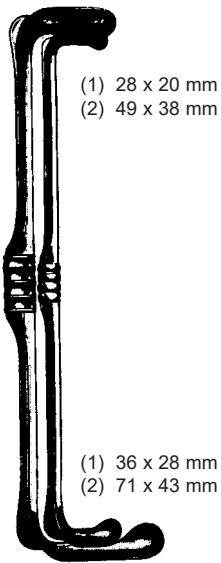


52x33 mm

30x21 mm

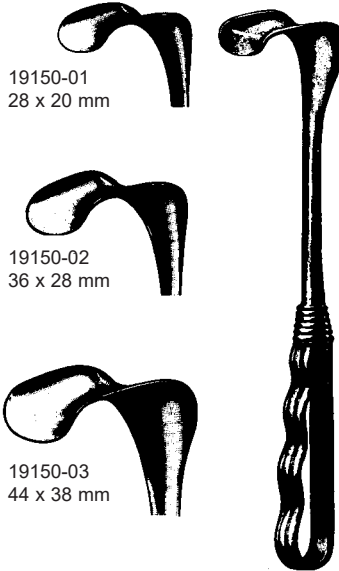
COLLIN-HARTMANN
19137-16 16 cm, 6 1/4"

Wundhaken
Retractors
Separadores
Divaricatori



(1) 28 x 20 mm
(2) 49 x 38 mm

(1) 36 x 28 mm
(2) 71 x 43 mm



19150-01
28 x 20 mm

19150-02
36 x 28 mm

19150-03
44 x 38 mm



47 x 21 mm

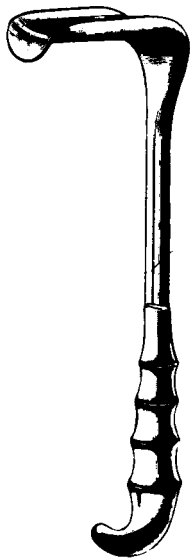
RICHARDSON-EASTMAN
(Set) 19140-00
(1) 19140-01 26 cm, 10 1/4"
(2) 19140-02 28 cm, 11"

RICHARDSON
24 cm, 9 1/2"

RICHARDSON
19150-04
24 cm, 9 1/2"



RICHARDSON GRIP
25 cm, 10"
19152-25 20 x 25 mm
19152-31 25 x 31 mm
19152-38 38 x 38 mm
19152-51 19 x 51 mm
19152-64 41 x 64 mm



KELLY GRIP
25 cm, 10"
19158-51 38 x 51 mm
19158-64 51 x 64 mm
19158-76 64 x 76 mm
19158-82 70 x 82 mm



19159-50
50x40 mm

19159-64
64x54 mm

19159-70
70x65 mm

19159-90
90x76 mm

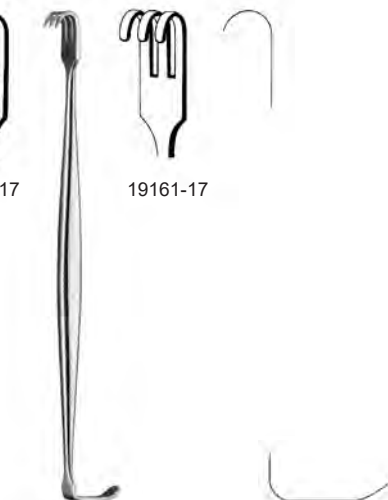
KELLY
26 cm, 10 1/4"

Wundhaken
Retractors
Separadores
Divaricatori



19160-17

19161-17

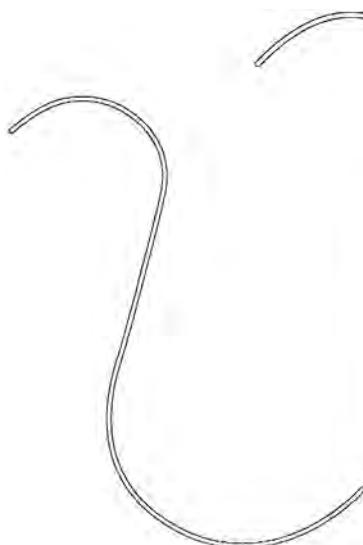


SENN-MILLER
17 cm, 6 ¾"

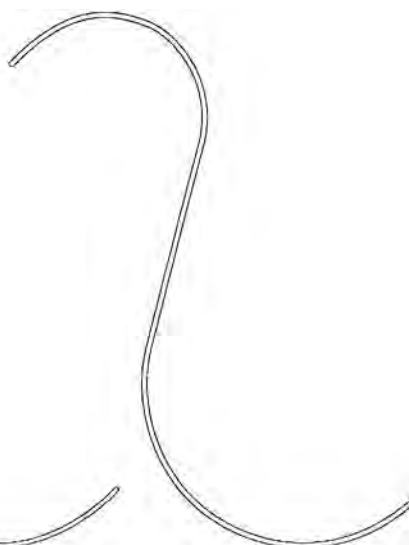


HASSON

Satz, set, juego, serie



19162-10 10 mm
16 cm, 6 ¼"



19162-13 13 mm
18 cm, 7"

Bauch- und Darmspatel
 Abdominal and intestinal spatulas
 Separadores, espátula intestinal y abdominal
 Divaricatori, spatole addominali e intestinali

biegsam, malleable, maleable, malleabili



RIBBON

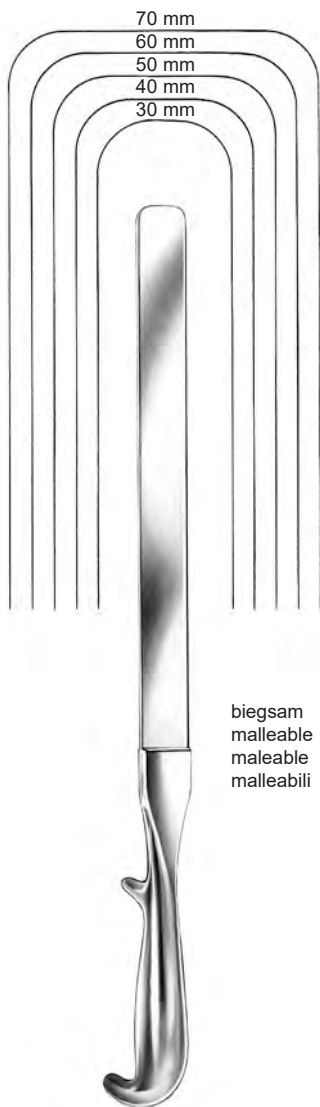
19168-06	6 x 200 mm
19168-08	8 x 200 mm
19168-10	10 x 200 mm
19168-12	12 x 200 mm
19168-17	17 x 200 mm
19168-20	20 x 200 mm
19168-25	25 x 200 mm
19169-25	25 x 250 mm



RIBBON

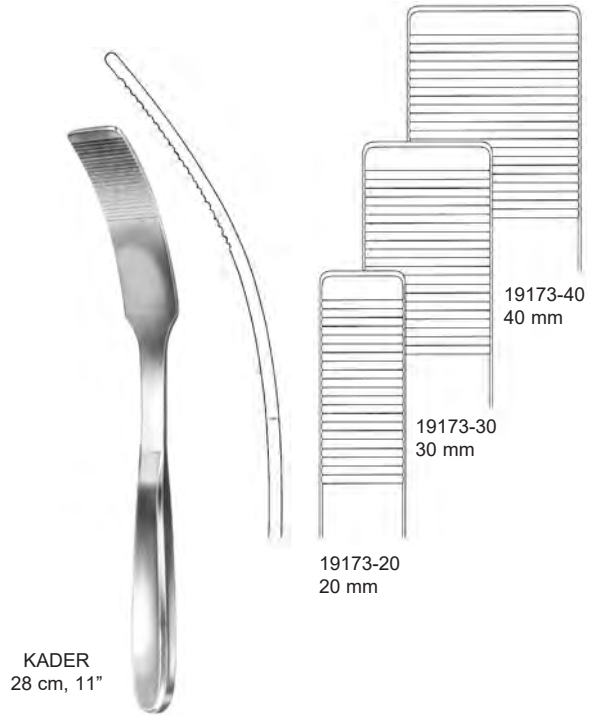
19170-20	20 x 330 mm
19170-25	25 x 330 mm
19170-32	32 x 330 mm
19170-40	40 x 330 mm
19170-45	45 x 330 mm
19170-50	50 x 330 mm
19170-65	65 x 330 mm
19170-76	76 x 330 mm

Bauch- und Darmspatel
Abdominal and intestinal spatulas
Separadores, espátula intestinal y abdominal
Divaricatori, spatole addominali e intestinali



41 cm, 16"
19171-30 30 mm
19171-40 40 mm
19171-50 50 mm
19171-60 60 mm
19171-70 70 mm

Bauch- und Darmspatel
 Abdominal and intestinal spatulas
 Separadores, espátula intestinal y abdominal
 Divaricatori, spatole addominali e intestinali

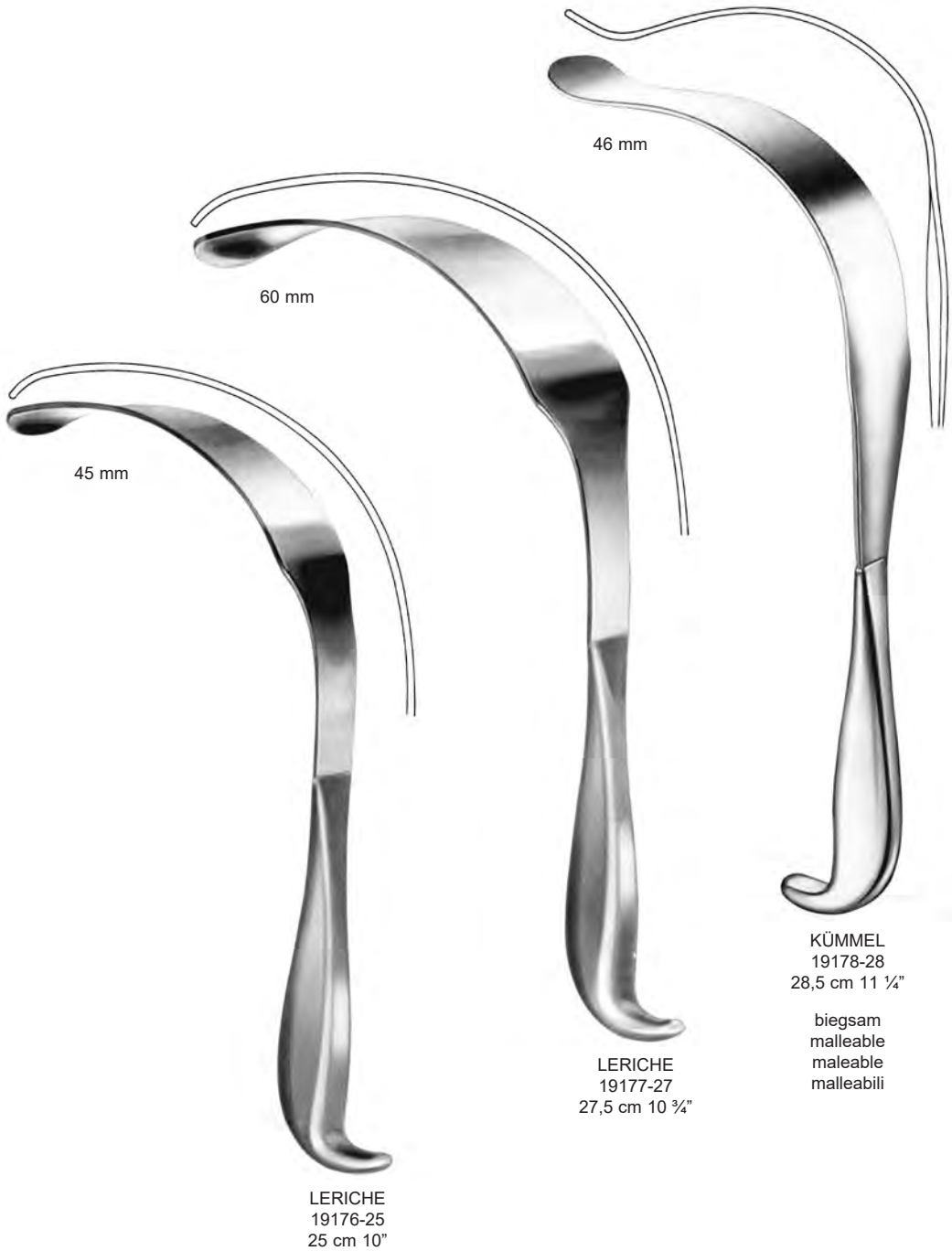


HABERER
 19174-17 17/25 x 200 mm
 19174-25 25/30 x 280 mm
 19174-37 37/45 x 300 mm
 19174-40 40/50 x 300 mm



REVERDIN
 19175-28
 28 cm, 11"

Bauch- und Darmspatel
 Abdominal and intestinal spatula
 Separadores, espátula intestinal y abdominal
 Divaricatori, spatole addominali e intestinali



Bauchspatel
Abdominal Spatulas
Espátula abdominal
Spatola addominale



KÜMMEL
19179-28
31 cm 12 ¼"

Wundhaken
Retractors
Separadores
Divaricatori



19 mm

DEAVER
19180-19
19 cm, 7 ½"



22 mm

DEAVER
19181-22
21,5 cm, 8 ½"



25 mm

DEAVER
19181-25
23 cm, 9"



25 mm

DEAVER
19183-25
30 cm, 11 ¾"



25 mm

DEAVER
19185-25
33 cm, 13"



25 mm

DEAVER
19187-25
36 cm, 14"

Wundhaken
Retractors
Separadores
Divaricatori



38 mm

DEAVER
19187-38
30 cm, 11 3/4"



50 mm

DEAVER
19187-50
31 cm, 12 1/4"



75 mm

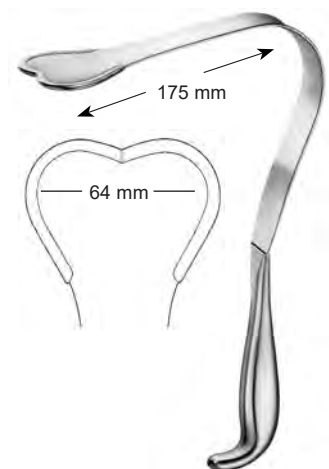
DEAVER
19187-75
32 cm, 12 3/4"



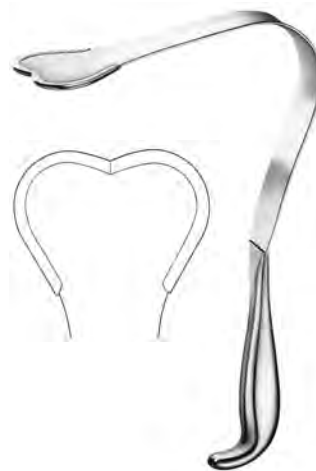
DEAVER GRIP

19189-25 25 x 310 mm
19189-38 38 x 310 mm
19189-50 50 x 310 mm
19189-75 75 x 310 mm
31 cm 12 1/4"

Wundhaken
Retractors
Separadores
Divaricatori



HARRINGTON-PEMBERTON
19190-64
29,5 cm 11 3/4"



HARRINGTON
19191-25 25x230 mm
19191-40 40x320 mm
19191-62 62x320 mm



TUFFIER
19192-23
23 cm, 9"

Wundhaken
Retractors
Separadores
Divaricatori

30°
rechts
right
a la derecha
a destra



45 x 48 mm

COOLEY
19195-01
24,5 cm, 9 3/4"

30°
rechts, gerieft
right serrated
a la derecha, estriado
a destra, zigrinato



45 x 48 mm

COOLEY
19195-02
24,5 cm, 9 3/4"

30°
links
left
a la izquierda
a sinistra



24 x 48 mm

COOLEY
19195-03
25,5 cm, 10"

Aortahaken
Aorta Retractors
Separadores para aorta
Divaricatori per aorta



ROSS

flexibler Schaft
flexible shaft
vástagó flexible
asta flessibile

13 x 16 mm



19196-01
24 cm, 9 ½"

11 x 22 mm



19196-02
24,5 cm, 9 ¾"

15 x 23 mm



19196-03
25 cm, 10"

12 x 28 mm



19196-04
25,5 cm, 10"

27 x 27 mm



19196-05
27 cm, 10 ½"

38 x 24 mm



19196-06
25,5 cm, 10"

Hauthäkchen
 Nerve and wound hooks
 Ganchos y ganchitos para nervios
 Uncini per nervi e divaricatori fini



GRAEFE
 19210-12
 scharf
 sharp
 agudo
 acuto



GRAEFE
 19211-12
 stumpf
 blunt
 romo
 smusso



12 cm, 4 $\frac{3}{4}$ "



GUTHRIE
 19212-01



GUTHRIE
 19212-02



scharf
 sharp
 agudo
 acuto
 A












stumpf
 blunt
 romo
 smusso
 B

FRAZIER

A	19214-13	13 cm, 5"
A	19214-18	18 cm, 7"
B	19215-13	13 cm, 5"
B	19215-18	18 cm, 7"

Wundhaken mit treangle-griff
 Retractor with treangle handle
 Retractor con mango triangular
 Divaricatore con impugnatura a treangolo

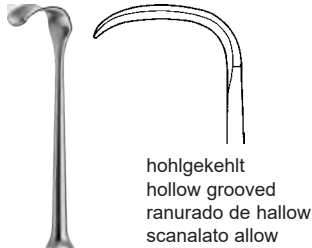
		5,0 x 4,0 mm	5,5 x 7,2 mm
	enge Biegung, scharf small curved sharp pequeña curva afilada piccolo curvo affilato		
		19213-01	19213-03
		5,5 x 4,0 mm	5,5 x 7,2 mm
	enge Biegung, stumpf small curved blunt pequeño y curvado romo piccolo curvo smussato		
		19213-04	19213-06
		8,0 x 8,0 mm	7,0 x 11 mm
	weite Biegung, scharf large curved sharp gran curva afilada grande curvo affilato		
		19213-07	19213-09
		7,0 x 8,0 mm	7,0 x 11 mm
	weite Biegung, stumpf large curved blunt gran curva roma grande curvo smussato		
		19213-10	19213-13
	MANNERFELT 15,5 cm, 6"		

Wundhaken mit treangle-griff
 Retractor with treangle handle
 Retractor con mango triangular
 Divaricatore con impugnatura a treangolo

enge Biegung, stumpf, flexibler schaft
 small curved blunt, flexible shaft
 pequeño y curvado romo, eje flexible
 piccolo curvo smussato, albero flessibile



MANNERFELT
 19214-04
 15,5 cm, 6"



MANNERFELT
 19214-16
 15,5 cm, 6"



LANGENBECK-MANNERFELT
 15,5 cm, 6"

15 x 6 mm



19214-15

20 x 6 mm



19214-20

25 x 6 mm



19214-25

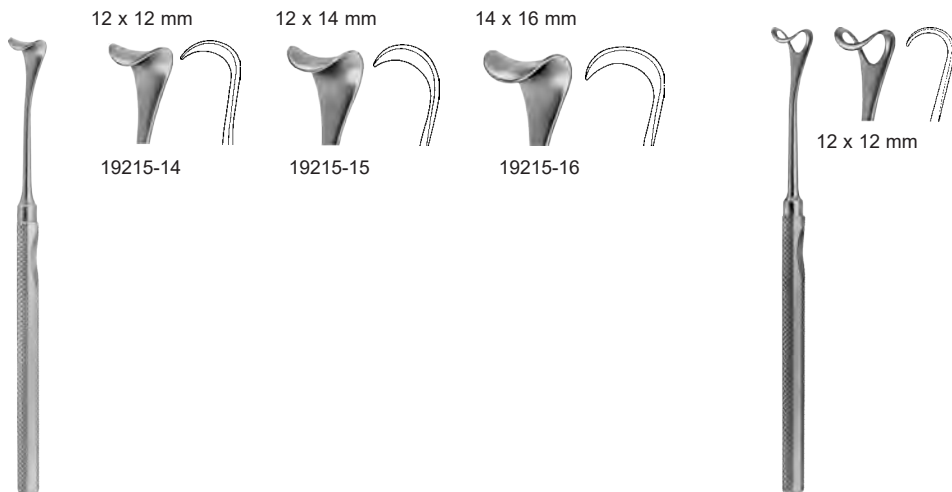
30 x 8 mm



19214-30

Wundhaken mit treangle-griff
 Retractor with treangle handle
 Retractor con mango triangular
 Divaricatore con impugnatura a triangolo

Sattelhaken
 Saddle hooks
 Ganchos de sillas
 Ganci da sella



MANNERFELT
 15,5 cm, 6"

MANNERFELT
 19215-05
 15,5 cm, 6"



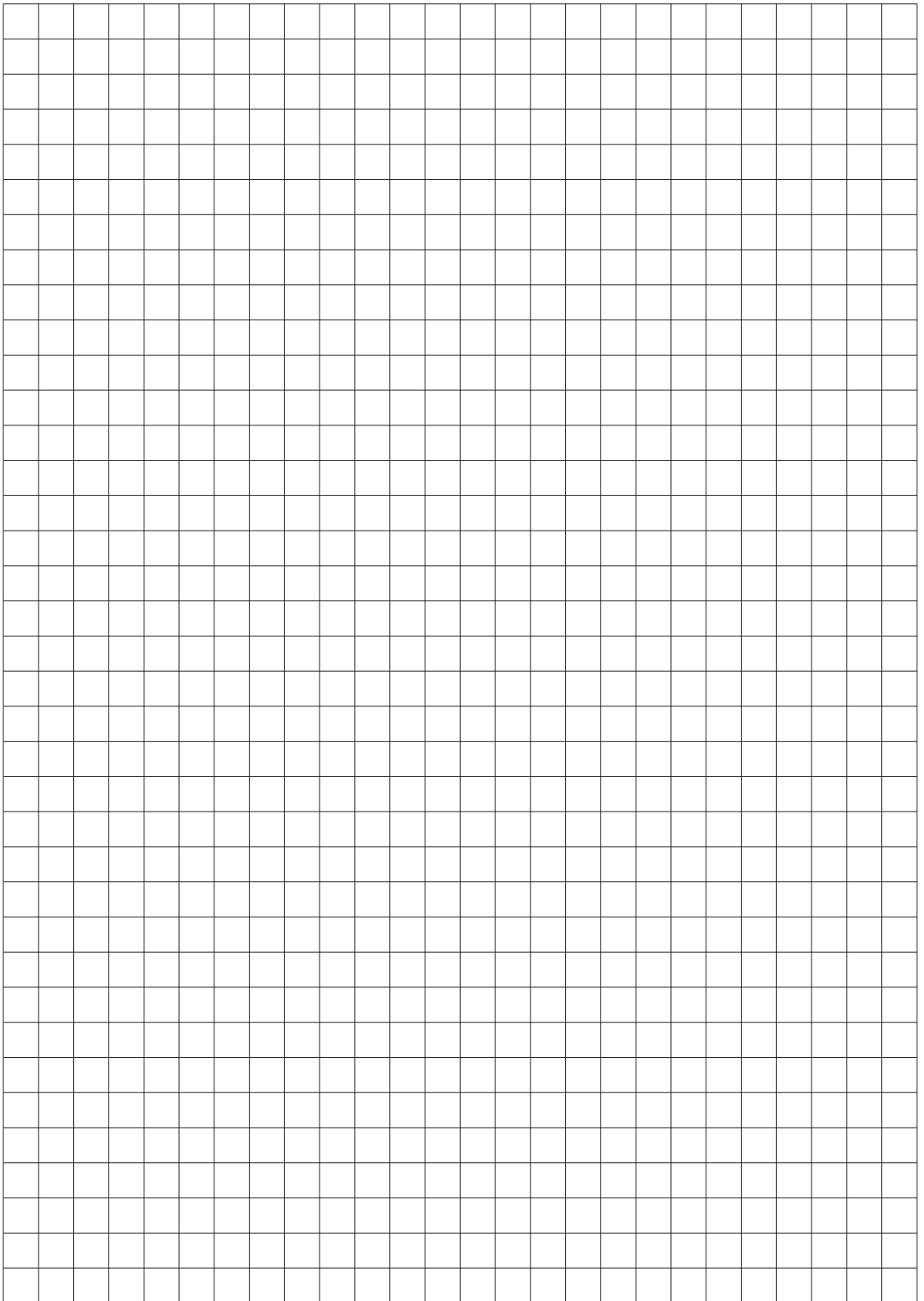
Sehnen-Doppelhaken
 Tendon double hook
 Gancho doble del tendón
 Gancio doppio del tendine

MANNERFELT
 19215-06
 16 cm, 6 1/4"

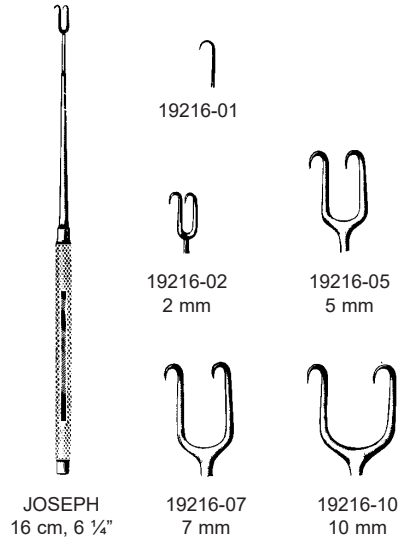


Doppelspatel
 Spatula, double-ended
 Espátula, doble punta
 Spatola, a doppia punta

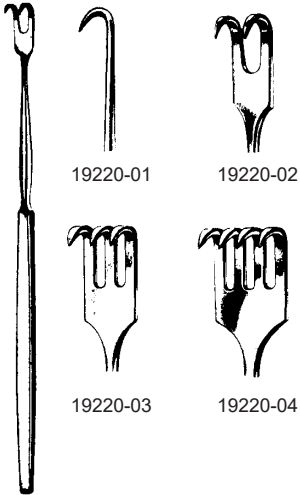
MANNERFELT
 19215-07
 16 cm, 6 1/4"



Hauthäkchen
Nerve and wound hooks
Ganchos y ganchitos para nervios
Uncini per nervi e divaricatori fini



Hauthäkchen
Nerve and wound hooks
Ganchos y ganchitos para nervios
Uncini per nervi e divaricatori fini



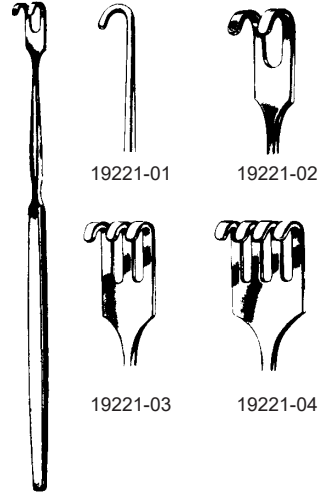
19220-01

19220-02

19220-03

19220-04

REDA
16 cm, 6 1/4"



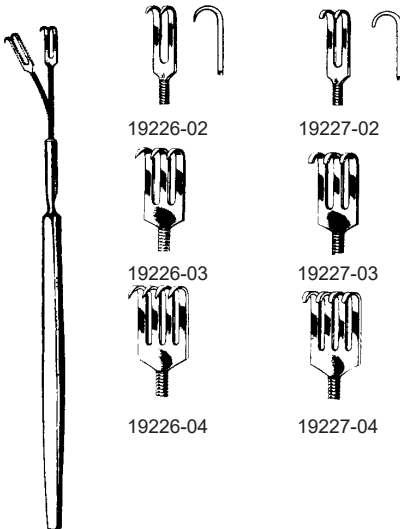
19221-01

19221-02

19221-03

19221-04

REDA
16 cm, 6 1/4"



19226-02

19227-02

19226-03

19227-03

19226-04

19227-04

REDA, flexibel
16 cm, 6 1/4"



19229-02

19229-03

KLAPP
17,5 cm, 6.9"

Sattelhäkchen
Saddle Hooks
Ganchos en forma de silla
Divaricatori a forma di sella



DESMARRES
16 cm, 6 1/4"



19230-12 12 mm



19230-10 10 mm



19230-14 14 mm



19230-16 16 mm



19230-18 18 mm



CUSHING
25 cm, 10"

19231-11
11x14 mm



19231-13
13x18 mm



19231-15
15x22 mm



CUSHING
20 cm, 8"



19232-08 8 mm



19232-10 10 mm



19232-12 12 mm



19232-14 14 mm



19232-16 16 mm

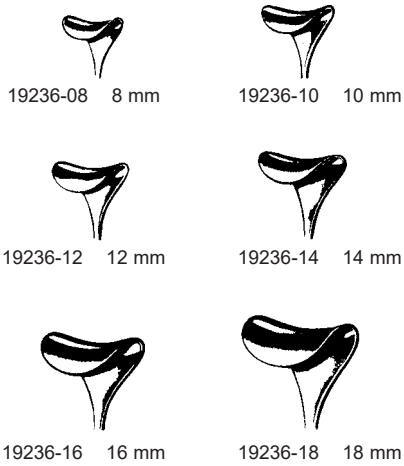


19232-18 18 mm

Sattelhäkchen
Saddle Hooks
Ganchos en forma de silla
Divaricatori a forma di sella

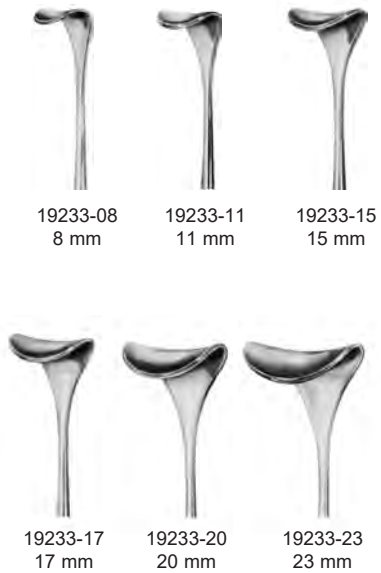


CUSHING
24 cm, 9 1/2"



GIL-VERNET
24 cm, 9 1/2"

biegsam
malleable
maleable
malleabile



Wundhaken
Retractors
Separadores
Divaricatori



CUSHING
19234-20
20 cm, 8"



CUSHING
19235-21
21,5 cm, 8 1/2"



KÖNIG
18 cm, 7"



19236-01
13x13 mm



19236-02
12x16 mm



SENN-GREEN
15 cm, 6"



19240-10 10x6 mm



19240-20 20x6 mm



LANGENBECK-GREEN
16 cm, 6 1/4"



19250-16
16x6 mm



19250-24
24x6 mm



VOLKMANN
11,5 cm, 4 1/2"



19270-02



19271-02



19270-03



19271-03



19270-04



19271-04



19270-06



19271-06

Wundhaken
Retractors
Separadores
Divaricatori



19280-01



19280-02



19280-03



19280-04



19280-06



scharf
sharp
agudo
acuto



19281-01



19281-02



19281-03



19281-04



19281-06



stumpf
blunt
romo
smusso



19282-02



19282-03



19282-04



19282-06



halbscharf
semi-sharp
medio romo
mezzo smusso



VOLKMANN
21,5 cm, 8 1/2"

Wundhaken
Retractors
Separadores
Divaricatori



19296-01



19296-02



19296-03



19296-04



19296-06



19296-08



scharf
sharp
agudo
acuto



19297-01



19297-02



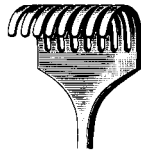
19297-03



19297-04



19297-06



19297-08



stumpf
blunt
romo
smusso



KOCHER
22 cm, 8 3/4"

Wundhaken
Retractors
Separadores
Divaricatori



Wundhaken
Retractors
Separadores
Divaricatori



MEYERDING
18 cm, 7"



19302-01 18x7 mm



19302-04 7x4 mm



19302-02 16x5 mm



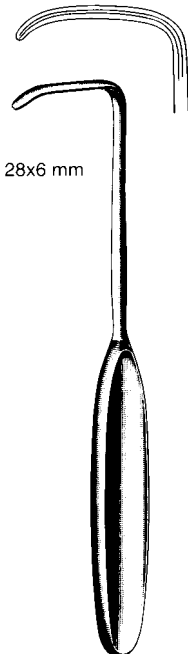
19302-05 10x3 mm



19302-03 7x4 mm

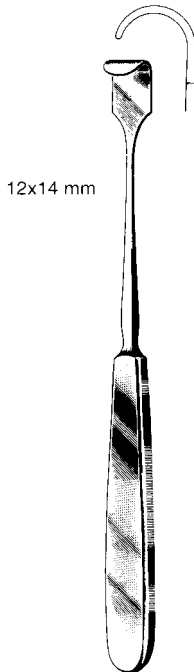


19302-06 10x4 mm



28x6 mm

LAHEY
19304-19
19 cm, 7 1/2"



12x14 mm

LITTLE
19306-20
20 cm, 8"



STRANDELL-STILLE
17 cm 6 3/4"

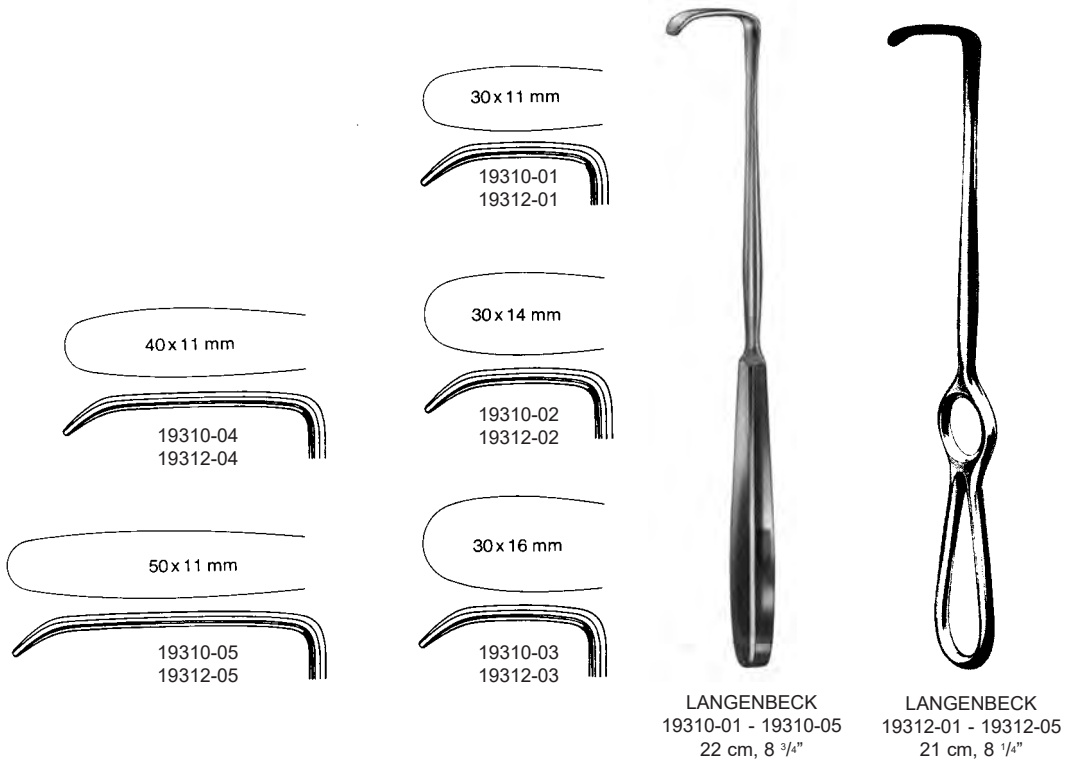


19307-01

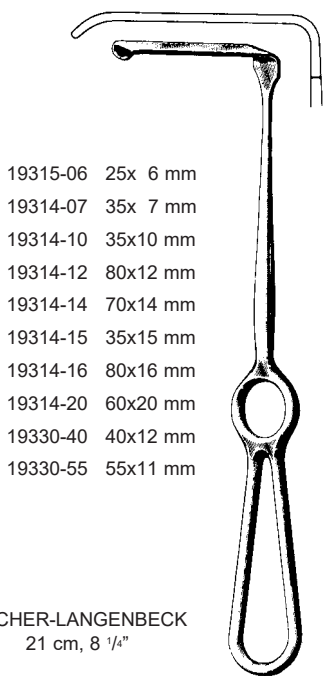


19307-02

Wundhaken
Retractors
Separadores
Divaricatori

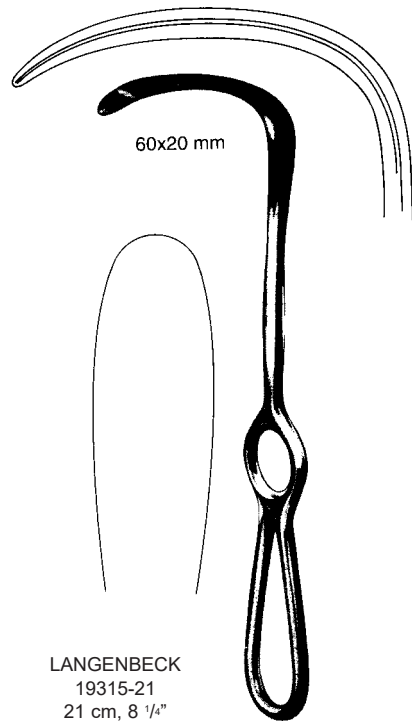


Wundhaken
Retractors
Separadores
Divaricatori

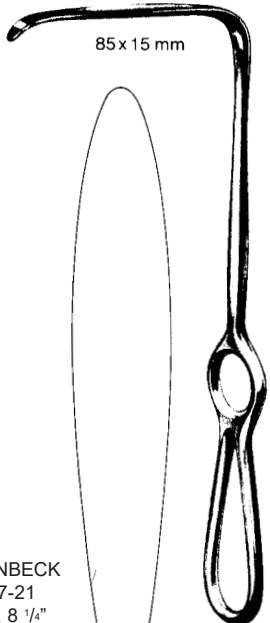


- 19315-06 25x 6 mm
- 19314-07 35x 7 mm
- 19314-10 35x10 mm
- 19314-12 80x12 mm
- 19314-14 70x14 mm
- 19314-15 35x15 mm
- 19314-16 80x16 mm
- 19314-20 60x20 mm
- 19330-40 40x12 mm
- 19330-55 55x11 mm

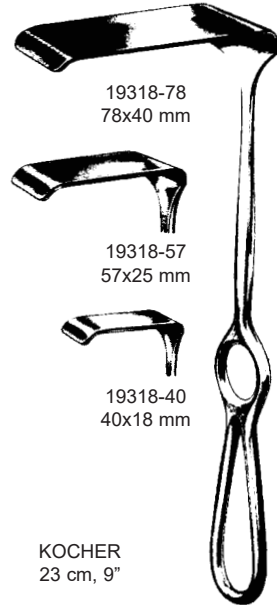
KOCHER-LANGENBECK
21 cm, 8 1/4"



LANGENBECK
19315-21
21 cm, 8 1/4"




LANGENBECK
19317-21
21 cm, 8 1/4"




KOCHER
23 cm, 9"


Wundhaken
Retractors
Separadores
Divaricatori



19344-14
14x17 mm
21,5 cm, 8 1/2"



19344-20
20x22 mm
22 cm, 8 3/4"



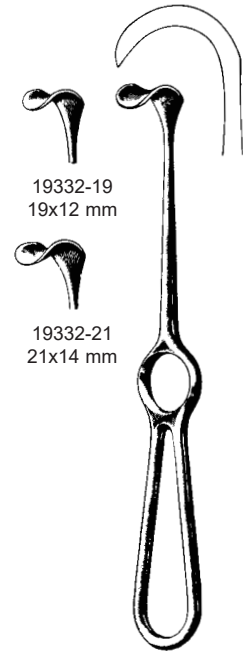
19344-26
26x30 mm
23,5 cm, 9 1/4"



MIDDLELDORPF
19344-14 - 19344-26



KOCHER
19340-10 40x10 mm
19340-15 40x15 mm
19340-20 40x20 mm
22 cm, 8 3/4"



19332-19
19x12 mm

19332-21
21x14 mm

KOCHER
19332-19 - 19332-21
19 cm, 7 1/2"



MIDDLELDORPF
19345-01 45x45 mm
25,5 cm, 10"



19345-02
45x50 mm



19345-03
55x70 mm



GREEN
19348-22
22 cm, 8 3/4"

Wundhaken
Retractors
Separadores
Divaricatori



35 x 8 mm

ZENKER
19350-35
25 cm, 10"



60 x 12 mm

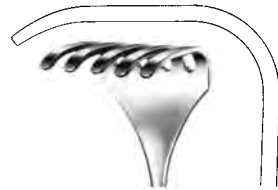
ZENKER
19350-60
26 cm, 10 1/4"



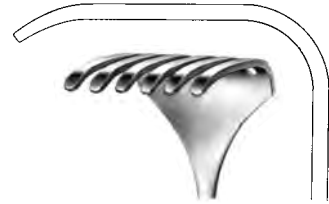
75 x 12 mm

ZENKER
19350-70
27,5 cm, 10.8"

Wundhaken
Retractors
Separadores
Divaricatori



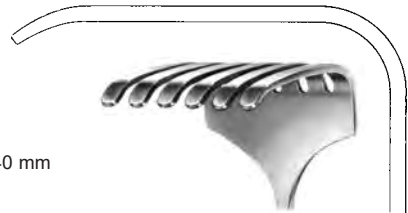
19364-50 45x50 mm



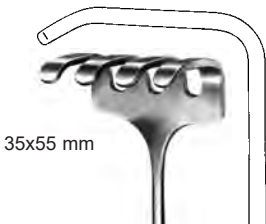
19364-60 50x60 mm



ISRAEL
19364-40 40X40 mm
25 cm, 10"



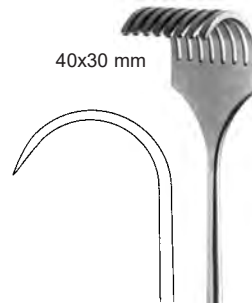
19364-70 70x70 mm



35x55 mm

OLLIER

19360-04 22,5 cm, 8.9"



40x30 mm

spitz
sharp
agudo
acuto

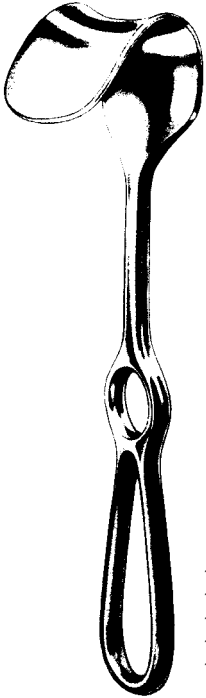
KOERTE

19366-08 23,5 cm, 9 1/4"

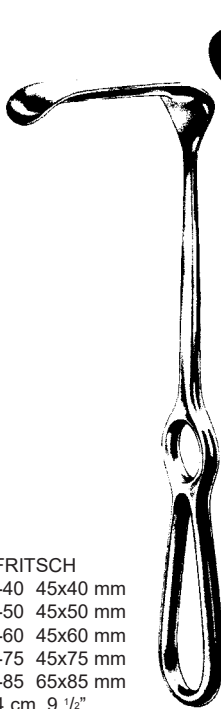
stumpf
blunt
romo
smusso

19367-08

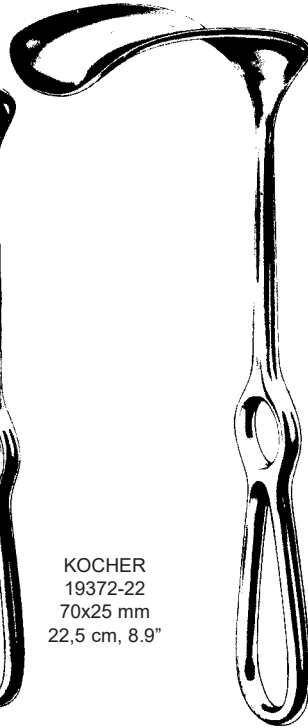
Wundhaken
Retractors
Separadores
Divaricatori



FRITSCH
19370-40 45x40 mm
19370-50 45x50 mm
19370-60 45x60 mm
19370-75 45x75 mm
19370-85 65x85 mm
24 cm, 9 1/2"



KOCHER
19372-22
70x25 mm
22,5 cm, 8.9"



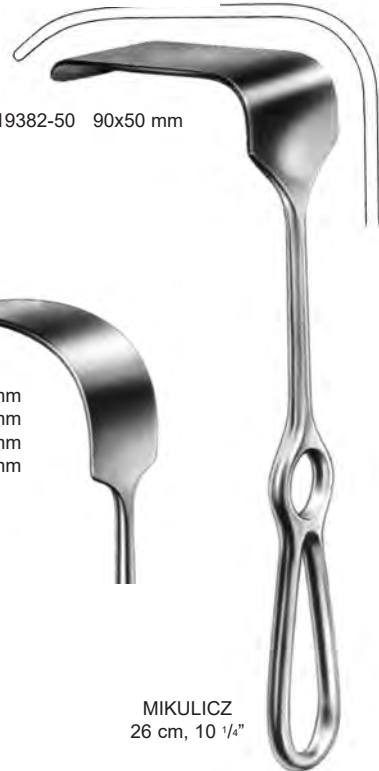
KOCHER
19374-45 80x45 mm
19374-55 80x55 mm
19374-65 80x65 mm
25 cm, 10"

50x85 mm



DOYEN
19378-25
25 cm, 10"

19382-50 90x50 mm



MIKULICZ
26 cm, 10 1/4"

19380-35 95x35 mm
19380-50 120x50 mm
19381-50 150x50 mm
19383-50 180x50 mm

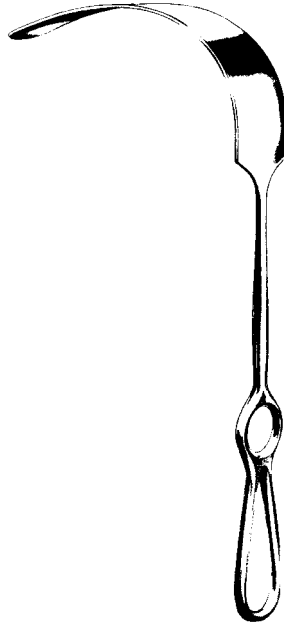
Wundhaken
Retractors
Separadores
Divaricatori



19388-40 70x40 mm
19388-50 70x50 mm
19388-65 70x65 mm



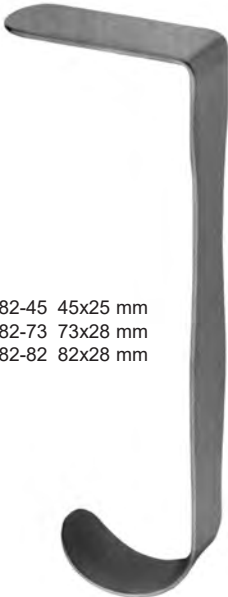
MORRIS
24,5 cm
9 3/4"



KELLY
19385-38 160x38 mm
19385-57 160x57 mm
27 cm, 10 1/2"

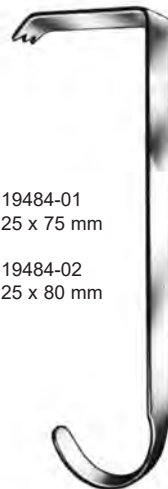


SIMON
19480-22 115x22 mm
19480-27 115x27 mm
28 cm, 11"



19482-45 45x25 mm
19482-73 73x28 mm
19482-82 82x28 mm

HEANEY
27 cm, 10 1/2"



19484-01
25 x 75 mm
19484-02
25 x 80 mm

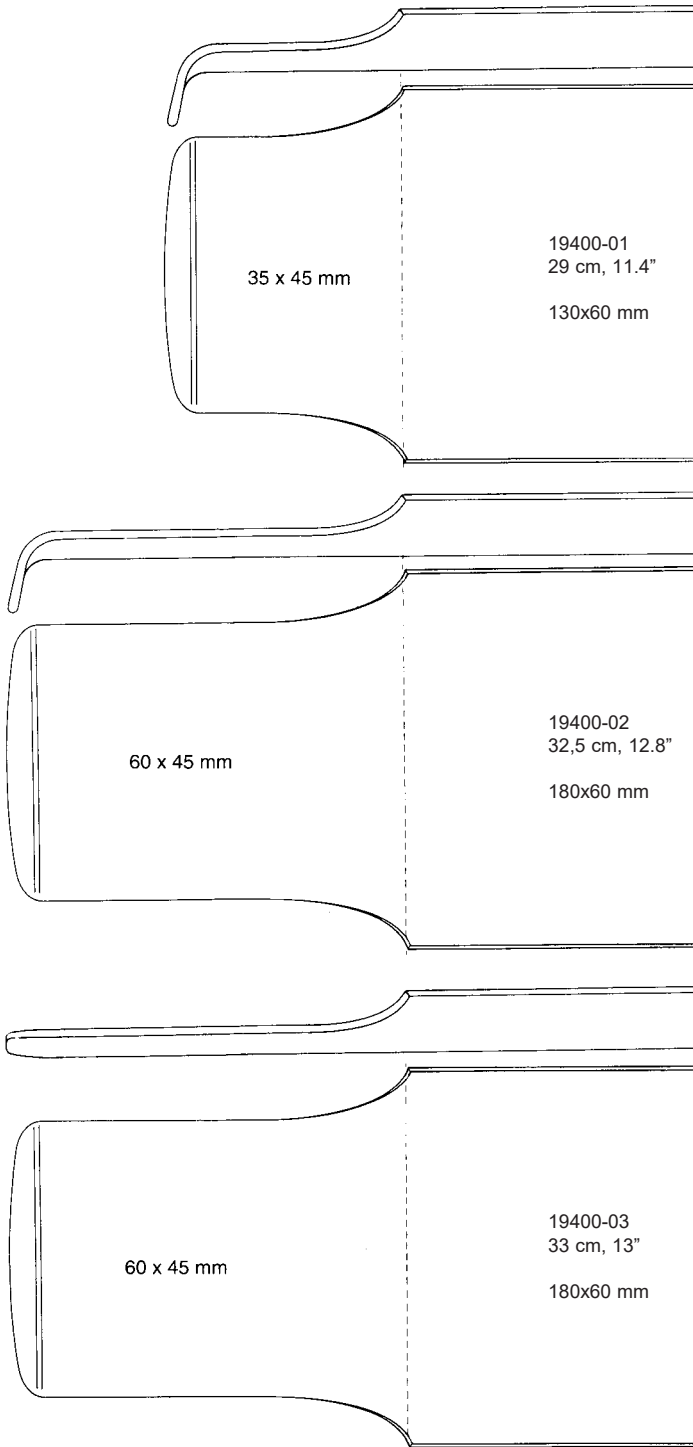
HIBBS
24 cm, 9 1/2"



125x37 mm

SAUERBRUCH
19492-25
25 cm, 10"

Pelvis-Haken
Pelvis retractor
Retractor de pelvis
Divaricatori pelvici



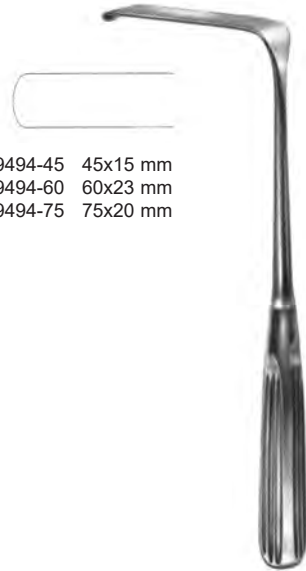
ST. MARKS
19400-01 19400-03

Wundhaken, Scapulahaken
 Retractors, Scapula Retractors
 Separadores, Separadores para escápula
 Divaricatori, Divaricatori per scapola



19490-65 115x65 mm
 19490-43 108x43 mm
 19490-22 82x22 mm

CORYLLOS (Thorax)
 24 cm, 9 1/2"



19494-45 45x15 mm
 19494-60 60x23 mm
 19494-75 75x20 mm

SAUERBRUCH
 22,5 cm, 8,9"

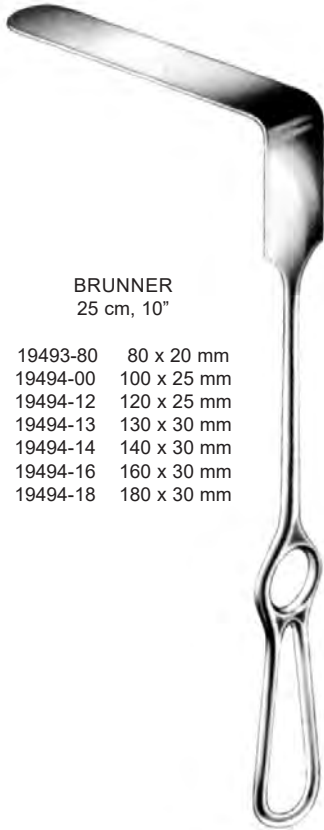


DAVIDSON
 19496-50 75x50 mm



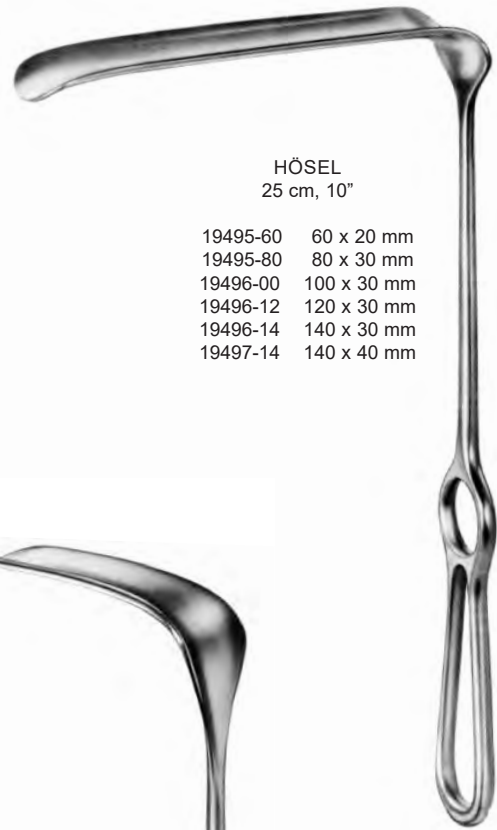
DAVIDSON
 19496-90 75x90 mm

Wundhaken
Retractors
Separadores
Divaricatori



BRUNNER
25 cm, 10"

19493-80	80 x 20 mm
19494-00	100 x 25 mm
19494-12	120 x 25 mm
19494-13	130 x 30 mm
19494-14	140 x 30 mm
19494-16	160 x 30 mm
19494-18	180 x 30 mm



HÖSEL
25 cm, 10"

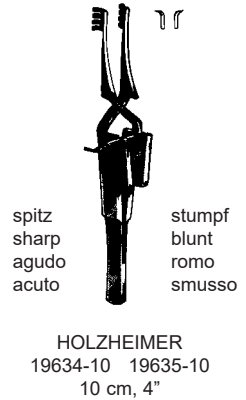
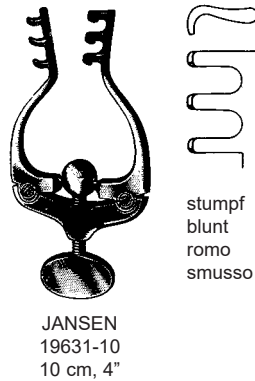
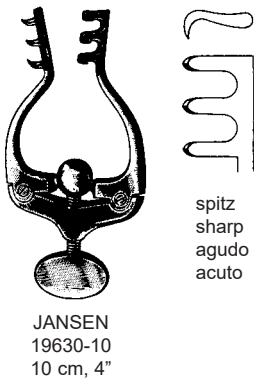
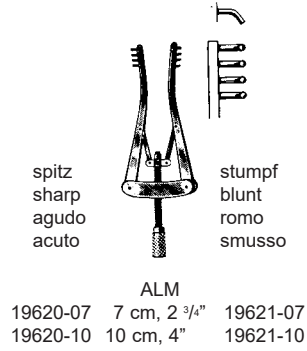
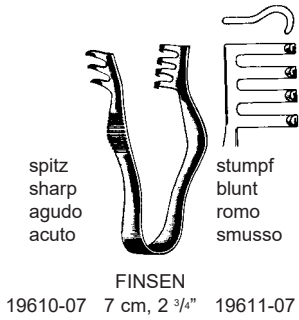
19495-60	60 x 20 mm
19495-80	80 x 30 mm
19496-00	100 x 30 mm
19496-12	120 x 30 mm
19496-14	140 x 30 mm
19497-14	140 x 40 mm



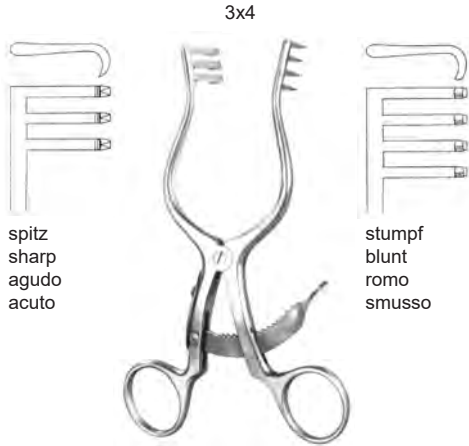
DOYEN-STILLE
25 cm, 10"

19498-01	97 x 29 mm
19498-02	101 x 31 mm
19498-03	127 x 52 mm

Wundsperrer, Kieferhöhlensperrer
 Retractors, Antrum Retractor
 Separadores, Separadores para seno maxilar
 Divaricatori, Divaricatori per seno mascellare



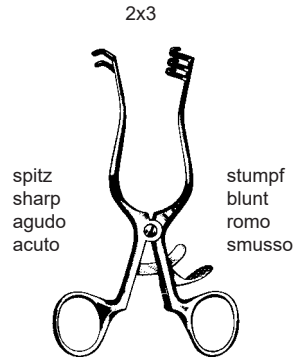
Wundsperrer
Retractors
Separadores
Divaricatori



spitz
sharp
agudo
acuto

stumpf
blunt
romo
smusso

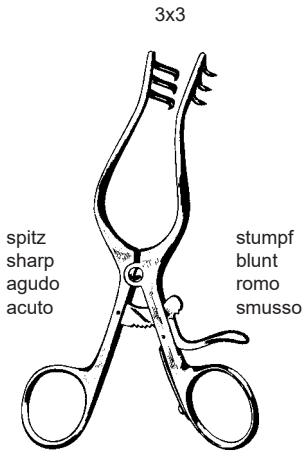
SCALP-CONTOUR
19640-14 - 19641-14
13,5 cm, 5 1/4"



spitz
sharp
agudo
acuto

stumpf
blunt
romo
smusso

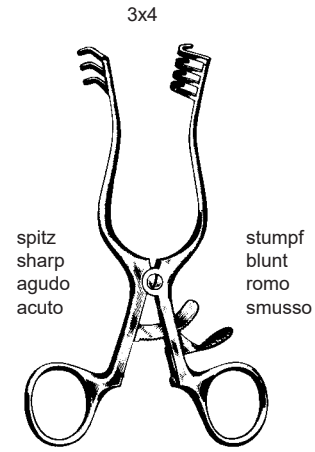
WEITLANER
19650-10 19651-10
11,5 cm, 4 1/2"



spitz
sharp
agudo
acuto

stumpf
blunt
romo
smusso

WEITLANER-WULLSTEIN
19654-13 19655-13
13 cm, 5 1/8"

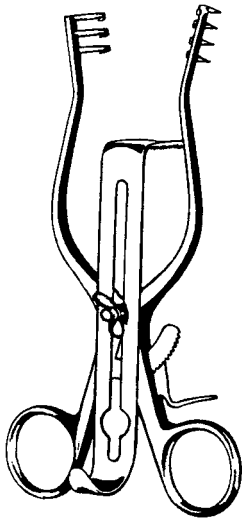


spitz
sharp
agudo
acuto

stumpf
blunt
romo
smusso

WEITLANER
19670-14 14,0 cm, 5 1/2" 19671-14
19670-16 16,5 cm, 6 1/2" 19671-16
19670-20 20,0 cm, 8" 19671-20
19670-24 24,0 cm, 9 1/2" 19671-24

Wundsperrer
Retractors
Separadores
Divaricatori



HENLEY
19675-00 - 19677-32
16,5 cm, 6 1/2"

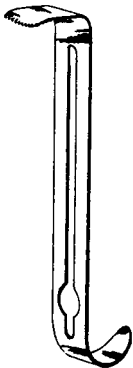


19675-00 komplett, stumpf, 3x4 Z. und 3 Valven
19675-00 complete, blunt, 3x4 teeth and 3 blades
19675-00 completo, romo, 3x4 dientes y 3 valvas
19675-00 completo, smusso, 3x4 d. e 3 valve

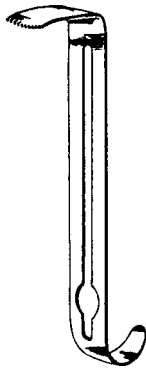
19676-00 komplett, scharf, 3x4 Z. und 3 Valven
19676-00 complete, sharp, 3x4 teeth and 3 blades
19676-00 complete, agudo, 3x4 dientes y 3 valvas
19676-00 completo con retr. acuto 3x4 d. e 3 valve

19678-05 Retraktor allein, stumpf 3x4 Zähne
19678-05 Retractor only, blunt 3x4 teeth
19678-05 Separador solo, romo, 3x4 dientes
19678-05 Retrattore solo, smusso 3x4 denti

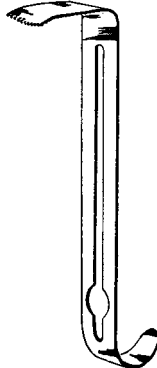
19678-06 Retraktor allein, spitz 3x4 Zähne
19678-06 Retractor only, sharp 3x4 teeth
19678-06 Separador solo, agudo, 3x4 dientes
19678-06 Retrattore solo, acuto 3x4 denti



19677-19
16x19 mm
5/8" x 3/4"



19677-25
16x25 mm
5/8" x 1"

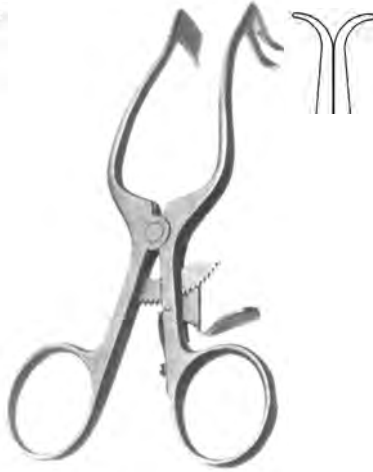


19677-32
16x32 mm
5/8" x 1 1/4"

Wundsperrer
Retractors
Separadores
Divaricatori



PLESTER
19672-11 11 cm, 4 3/8"
stumpf - blunt - romo - smusso



PLESTER
19673-11 11 cm, 4 3/8"
stumpf - blunt - romo - smusso



MOLLISON
19674-15 15 cm, 6"
scharf - sharp - agudo - acuto



WULLSTEIN
19675-13 13 cm, 5 1/8"
stumpf - blunt - romo - smusso

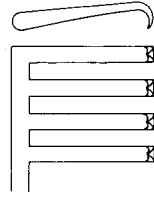
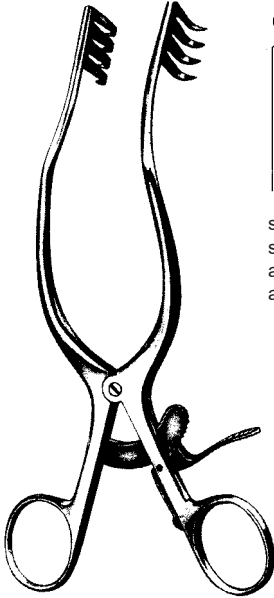


PLESTER
19677-13 13 cm, 5 1/8"
scharf - sharp - agudo - acuto



MAYO-ADAMS
19678-16 16,5 cm, 6 1/2"
stumpf - blunt - romo - smusso

Wundsperrer
Retractors
Separadores
Divaricatori



spitz
sharp
agudo
acuto

ANDERSON ADSON
19679-20 19,5 cm, 7 3/4"



stumpf
blunt
romo
smusso

NORFOLK / NORWICH
19679-22 22 cm, 8 3/4"



spitz
sharp
agudo
acuto

ADSON
19680-19 19 cm, 7 1/2" 19681-19

stumpf
blunt
romo
smusso



stumpf
blunt
romo
smusso

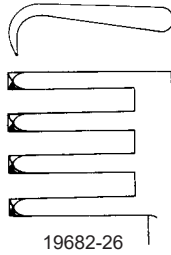
TRAVERS
19681-21 21,5 cm, 8 1/2"

Wundsperrer
Retractors
Separadores
Divaricatori



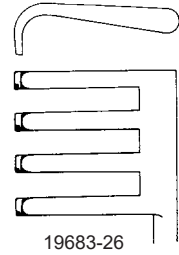
ADSON
19682-26 - 19683-26
26,5 cm, 10 1/2"

spitz
sharp
agudo
acuto



19682-26

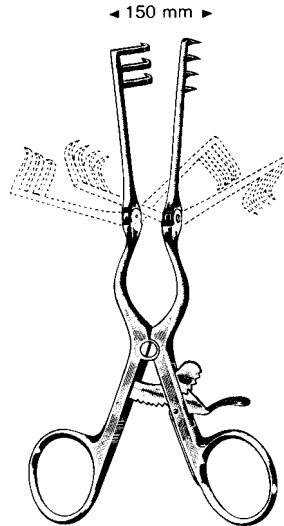
stumpf
blunt
romo
smusso



19683-26

- 19684-14 14 cm, 5 1/2"
- 19684-16 16 cm, 6 1/4"
- 19684-20 20 cm, 8"
- 19684-26 26 cm, 10 1/4"

spitz
sharp
agudo
acuto

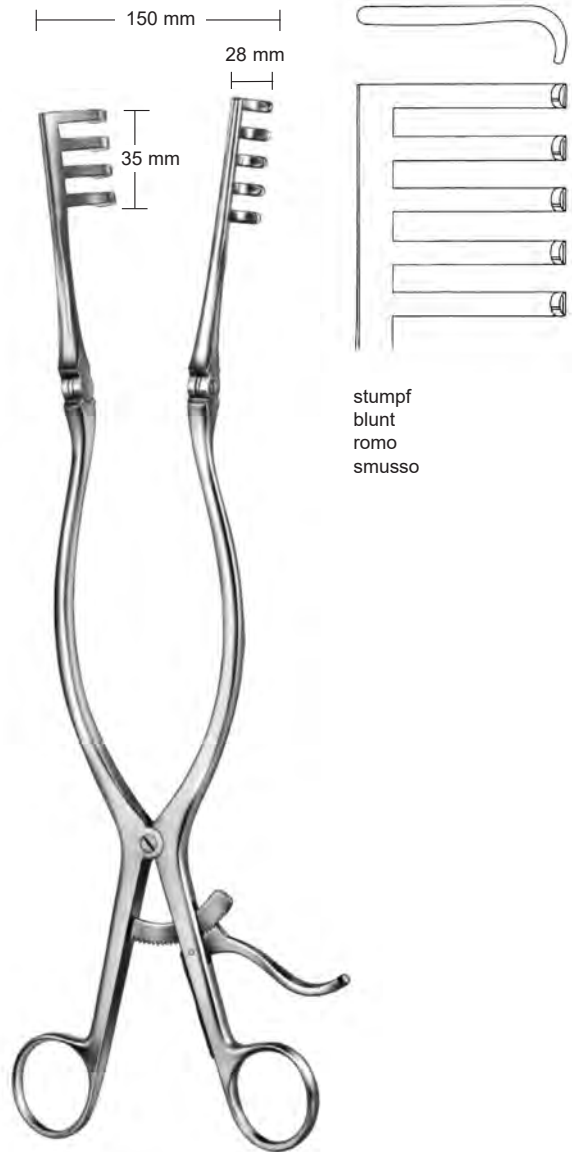


ADSON

- 19685-14 14 cm, 5 1/2"
- 19685-16 16 cm, 6 1/4"
- 19685-20 20 cm, 8"
- 19685-26 26 cm, 10 1/4"

stumpf
blunt
romo
smusso

Wundsperrer
Retractors
Separadores
Divaricatori

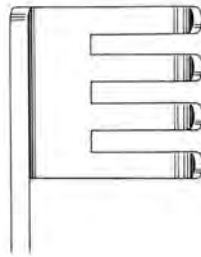


ADSON
19686-32
32 cm, 12 3/4"

Wundsperrer
Retractors
Separadores
Divaricatori

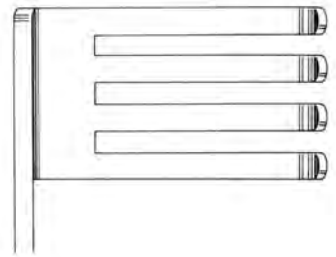


BECKMAN-ADSON
31 cm, 12 1/4"



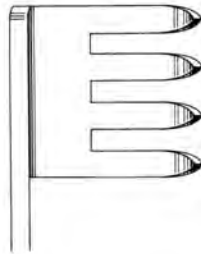
19687-01
25 x 31 mm

stumpf
blunt
romo
smusso



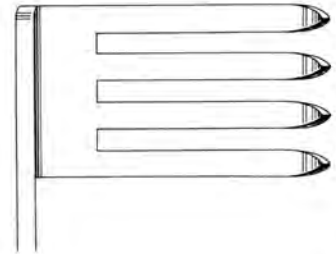
19688-01
45 x 27 mm

stumpf
blunt
romo
smusso



19687-02
25 x 31 mm

scharf
sharp
agudo
acuto



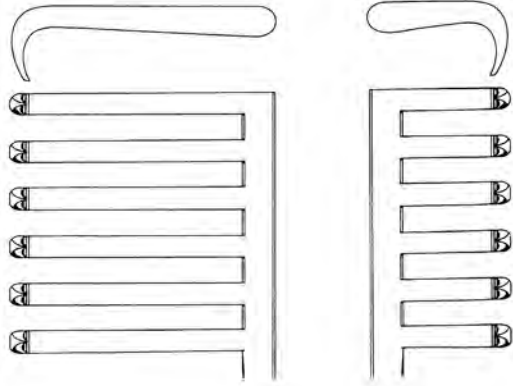
19688-02
45 x 27 mm

scharf
sharp
agudo
acuto

Wundsperrer
Retractors
Separadores
Divaricatori

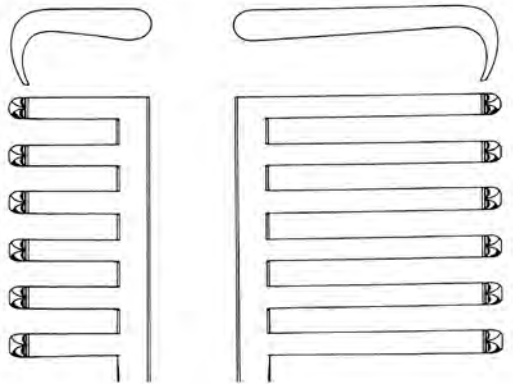


MARTIN
28,5 cm, 11 1/4"



19689-01
6x6 Zähne

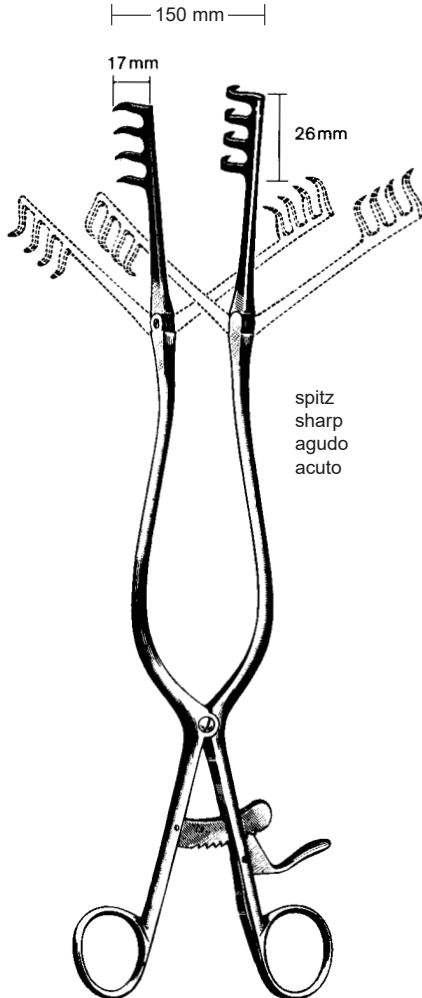
scharf, lange Zähne links
sharp, long teeth on left side
agudo, dientes largos a la izquierda
acuto, denti lunghe a sinistra



19689-02
6x6 Zähne

scharf, lange Zähne rechts
sharp, long teeth on right side
agudo, dientes largos a la derecha
acuto, denti lunghe a destra

Wundhaken
Retractors
Separadores
Divaricatori



BECKMANN
19690-31
31 cm, 12 1/4"



BECKMANN-EATON
19692-32
32 cm, 12 3/4"

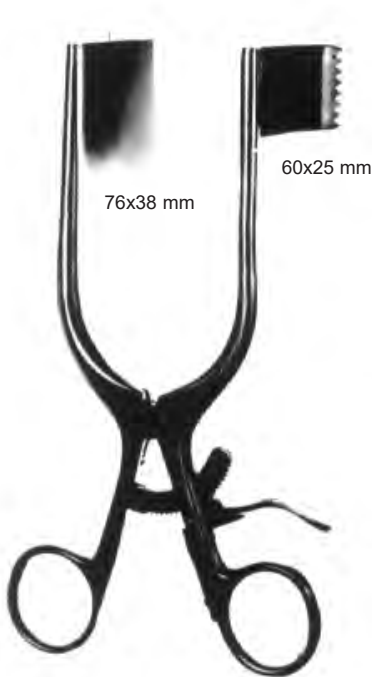
Wundsperrer
Retractors
Separadores
Divaricatori



19694-01 20 cm, 8" 50 x 16 mm
19694-02 23 cm, 9" 75 x 25 mm
19694-03 24 cm, 9 1/2" 90 x 50 mm

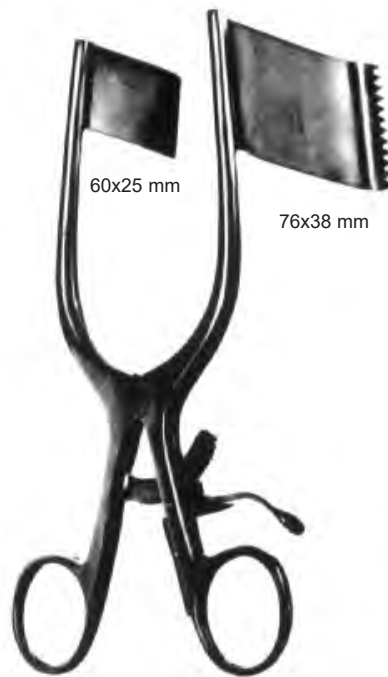
MEYERDING

Hemilaminectomiespreizer
 Hemilaminectomy Retractor
 Separadores para hemilaminectomía
 Divaricatori per emilaminectomia



DARLING
19696-18 18 cm, 7"

links
left
a la izquierda
a sinistra



DARLING
19698-18 18 cm, 7"

rechts
right
a la derecha
a destra

Cervicalspreizer
Cervical Retractor
Separador cervical
Divaricatore cervicale



CLOWARD
25 cm, 10"



spitz
sharp
agudo
acuto

19710-40	40 x 15 / 23 mm
19710-45	45 x 15 / 23 mm
19710-50	50 x 15 / 23 mm
19710-55	55 x 15 / 23 mm
19710-60	60 x 15 / 23 mm

19710-01
Sperrer, alleine
Retractor, only
Retractor, suelto
Divaricatore solo

19710-00
Sperrer komplett mit 5 Valven spitz
Retractor complete with 5 blades sharp
Separador completo con 5 valvas agudas
Divaricatore completo con 5 valve acute

Cervicalspreizer
 Cervical Retractor
 Separador cervical
 Divaricatore cervicale



CLOWARD
 25 cm, 10"

stumpf
 blunt
 romo
 smusso



19711-40	40 x 15 / 23 mm
19711-45	45 x 15 / 23 mm
19711-50	50 x 15 / 23 mm
19711-55	55 x 15 / 23 mm
19711-60	60 x 15 / 23 mm

19710-01
 Sperrer, alleine
 Retractor, only
 Retractor, suelto
 Divaricatore solo

19712-00
 Sperrer komplett mit 5 Valven stumpf
 Retractor complete with 5 blades blunt
 Separador completo con 5 valvas romas
 Divaricatore completo con 5 valve smusse

Cervicalspreizer
Cervical Retractor
Separador cervical
Divaricatore cervicale

spitz
sharp
agudo
acuto



19710-40	40 x 15 / 23 mm
19710-45	45 x 15 / 23 mm
19710-50	50 x 15 / 23 mm
19710-55	55 x 15 / 23 mm
19710-60	60 x 15 / 23 mm



CLOWARD
16 cm, 6 1/4"

19711-01
Sperrer, alleine
Retractor, only
Retractor, suelto
Divaricatore solo

19711-00
Sperrer komplett mit 5 Valven spitz
Retractor complete with 5 blades sharp
Separador completo con 5 valvas agudas
Divaricatore completo con 5 valve acute

Cervicalspreizer
 Cervical Retractor
 Separador cervical
 Divaricatore cervicale

stumpf
 blunt
 romo
 smusso



- 19711-40 40 x 15 / 23 mm
- 19711-45 45 x 15 / 23 mm
- 19711-50 50 x 15 / 23 mm
- 19711-55 55 x 15 / 23 mm
- 19711-60 60 x 15 / 23 mm

19711-01
 Sperrer, alleine
 Retractor, only
 Retractor, suelto
 Divaricatore solo



CLOWARD
 16 cm, 6 1/4"

19713-00
 Sperrer komplett mit 5 Valven stumpf
 Retractor complete with 5 blades blunt
 Separador completo con 5 valvas romas
 Divaricatore completo con 5 valve smusse

Cervicalspreizer
Cervical Retractor
Separador cervical
Divaricatore cervicale

90 mm, 3 1/2"



CASPAR
19721-15
165 mm, 5 1/2"

Sperrer, alleine
Retractor, only
Retractor, suelto
Divaricatore solo



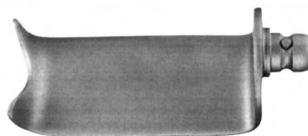
19726-01

Blätter-Wechselpinzette
Blade ejector
Pinza para cambiar hojas
Pinze per cambiare valve

19721-00

Sperrer komplett mit 5 Valven stumpf
Retractor complete with 5 blades blunt
Separador completo con 5 valvas romas
Divaricatore completo con 5 valve smusse

19738-45	45 x 23 mm
19738-50	50 x 23 mm
19738-55	55 x 23 mm
19738-60	60 x 23 mm
19738-65	65 x 23 mm



Lumbal-Wundspreizer
 Lumbal Retractors
 Separadores lumbales autoestáticos
 Divaricatori autostatici lombari



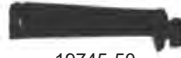
19745-40
 40 mm, 1 1/2"



19745-45
 45 mm, 1 3/4"



19745-60
 60 mm, 2 1/4"



19745-50
 50 mm, 2"



19745-65
 65 mm, 2 1/2"



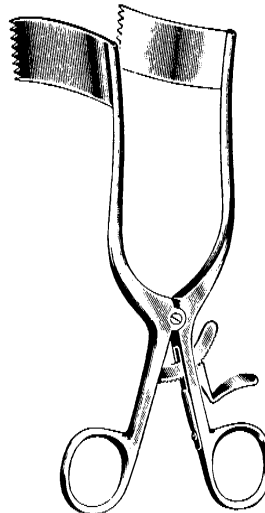
19745-55
 55 mm, 2 1/8"



19745-70
 70 mm, 2 3/4"

CASPAR
 19744-00
 komplett mit 7 Blätter
 compl. incl. 7 blades
 completo con 7 valvas
 complete di 7 valve

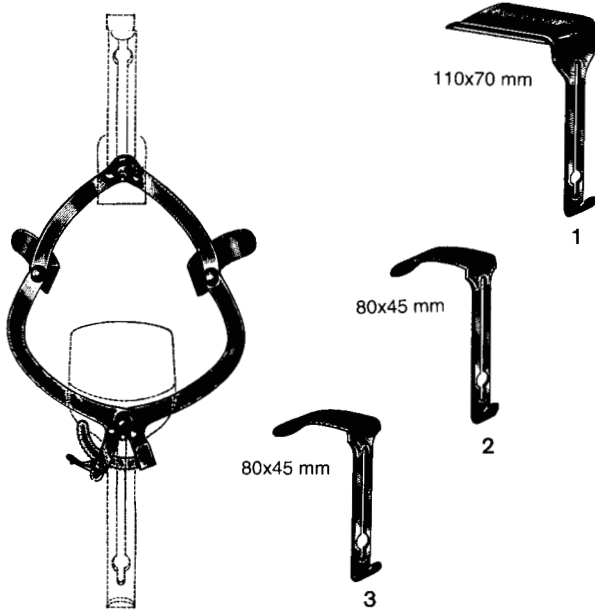
19744-17
 ohne Blätter
 without blades
 sin valvas
 senza valve



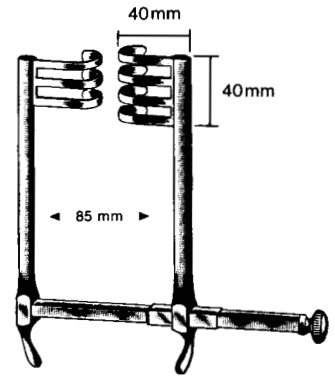
MEYERDING
 17 cm, 6 3/4"

19748-01 2,5 x 3,2 cm
 19748-02 2,5 x 5,4 cm
 19748-03 1,9 x 6,0 cm
 19748-04 2,5 x 6,0 cm

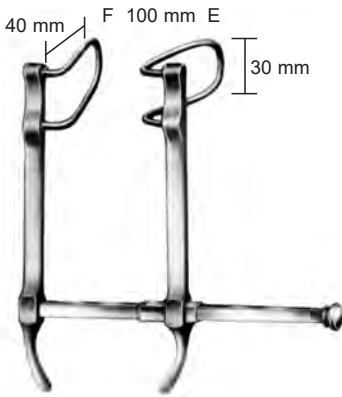
Bauchdeckenhalter
 Abdominal Retractors
 Separadores abdominales
 Divaricatori addominali



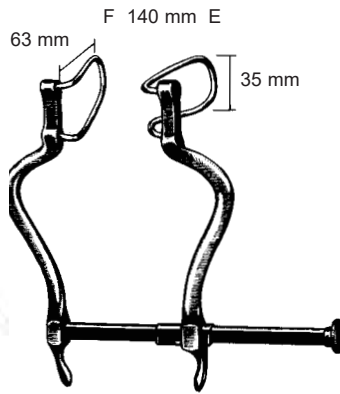
O'SULLIVAN - O'CONNOR
 19754-00
 compl.



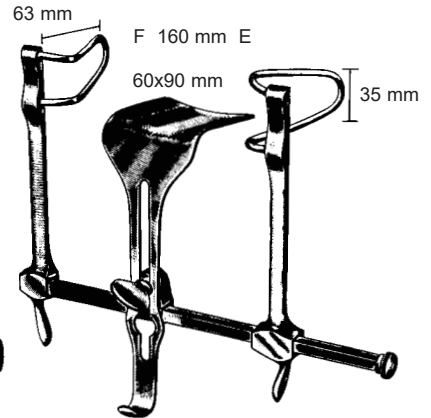
FRAZIER
 19758-85



BABY GOSSET
 19759-00

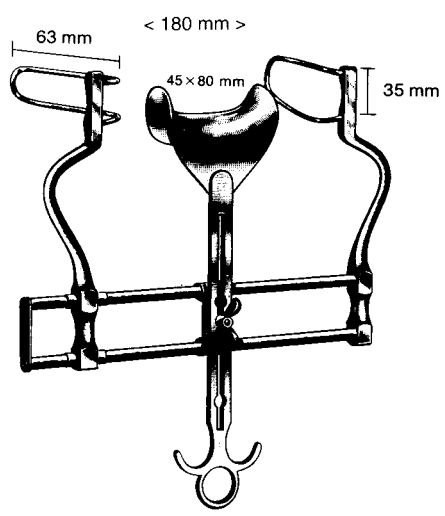


GOSSET
 19760-14

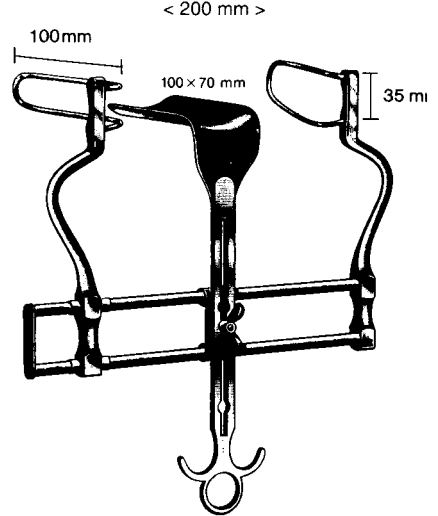


GOSSET
 19762-16

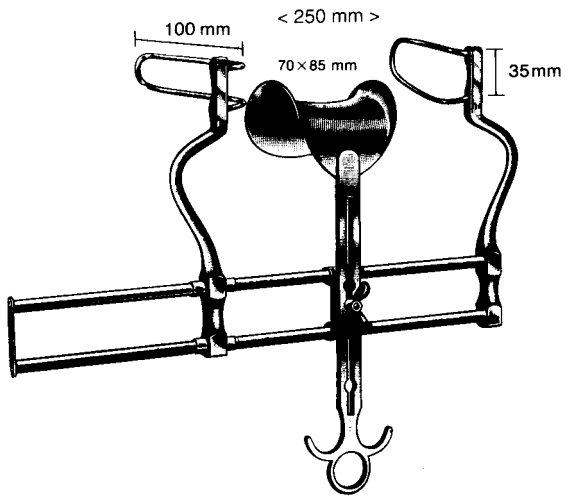
Bauchdeckenhalter
Abdominal Retractors
Separadores abdominales
Divaricatori addominali



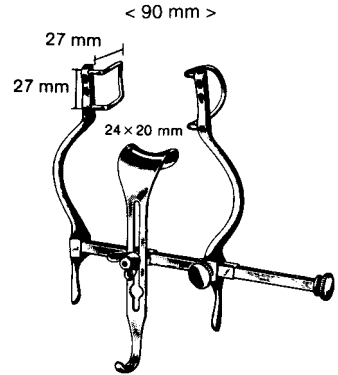
BALFOUR
19764-18
18 cm, 7"



BALFOUR
19764-20
20 cm, 8"

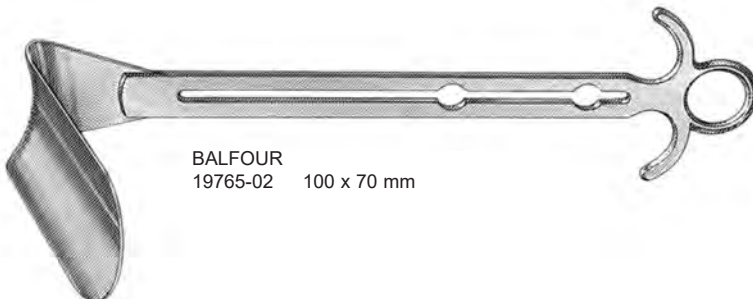
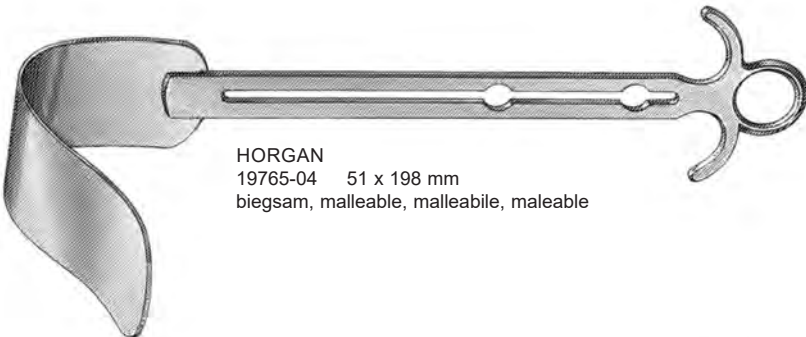
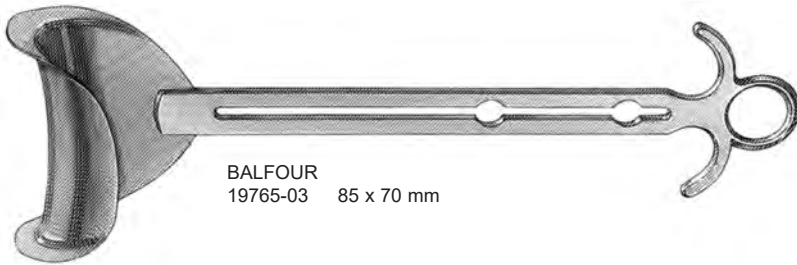
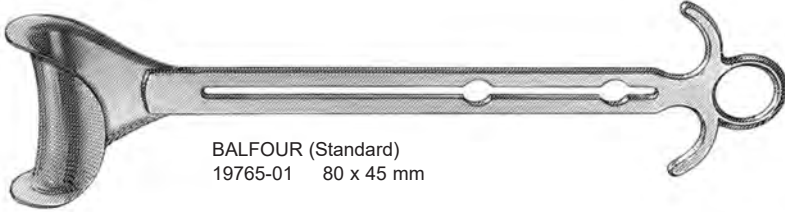


BALFOUR
19764-25
25 cm, 10"



BALFOUR Baby
19766-90
9 cm, 3 1/2"

Bauchdeckenhalter
Abdominal Retractors
Separadores abdominales
Divaricatori addominali



Bauchdeckenhalter
Abdominal Retractors
Separadores abdominales
Divaricatori addominali



BALFOUR-US
19767-18
19767-25
komplett
complete
completo

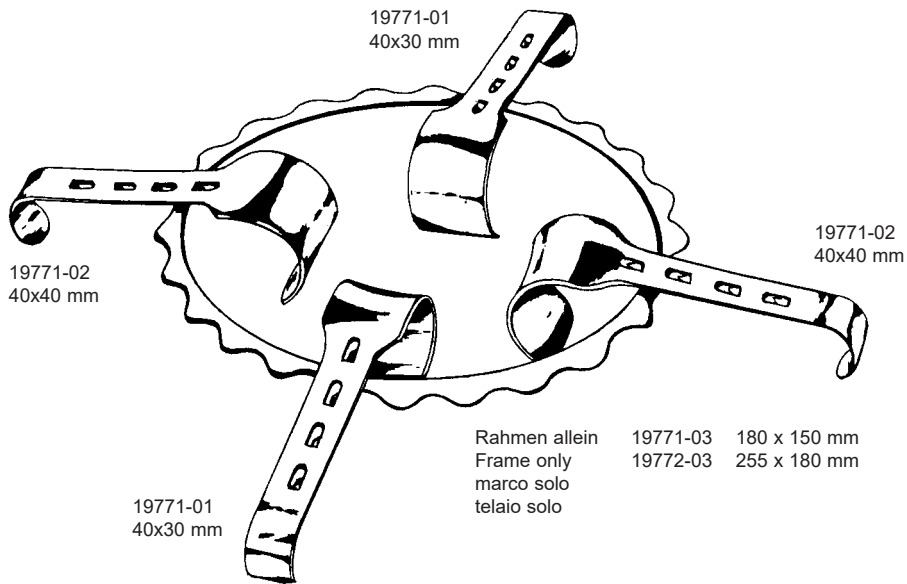


19767-01
Drahtvalven 5 cm (1.96") tief (Paar)
Fenestrated blades 5 cm (1.96") deep (pair)
Valvas de alambre 5 cm (1.96") profundidad (par)
Valve di filo profondità 5 cm (1.96") (paio)

19767-02
Drahtvalven 7,5 cm (2,95") tief (Paar)
Fenestrated blades 7,5 cm (2,95") deep (pair)
Valvas de alambre 7,5 cm (2,95") profundidad (par)
Valve di filo profondità 7,5 cm (2,95") (paio)

19767-03
Drahtvalven 10 cm (4") tief (Paar)
Fenestrated blades 10 cm (4") deep (pair)
Valvas de alambre 10 cm (4") profundidad (par)
Valve di filo profondità 10 cm (10") (paio)

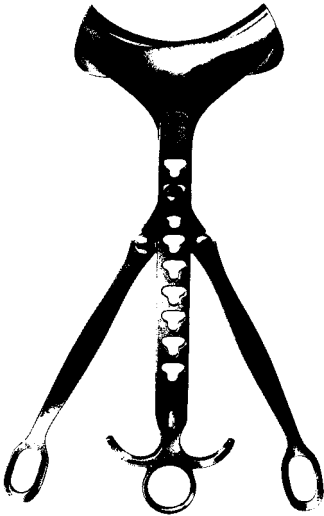
Bauchdeckenhalter
Abdominal Retractors
Separadores abdominales
Divaricatori addominali



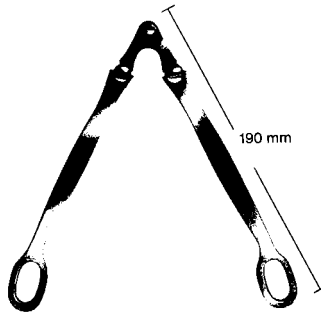
DENIS-BROWNE

19771-00 compl. Pediatric/pediatrico 180 x 150 mm
19772-00 compl. Adult/adulto 255 x 180 mm

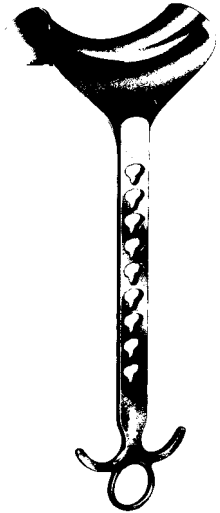
Bauchdeckenhalter
 Abdominal Retractors
 Separadores abdominales
 Divaricatori addominali



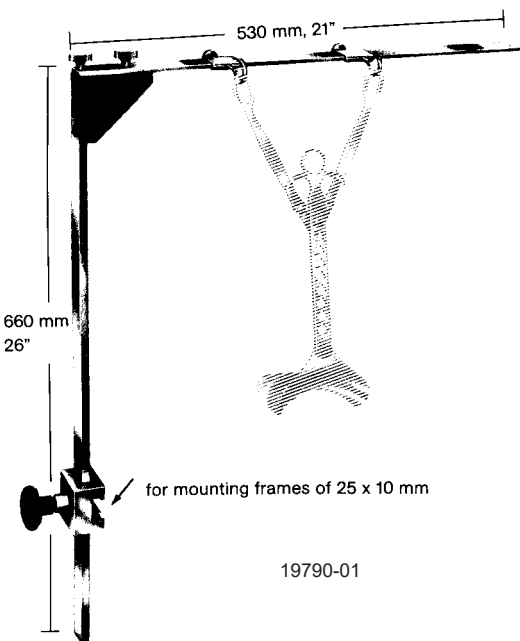
19780-01 + 19770-01



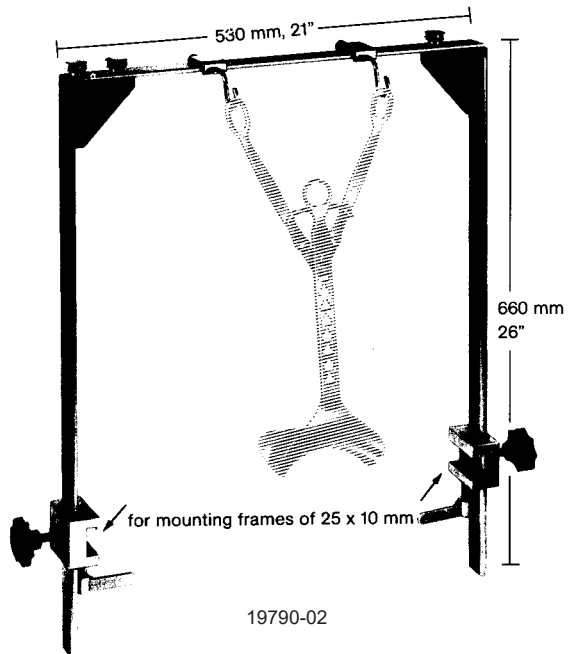
ROCHARD
 19780-01



ROCHARD
 31 cm, 12 1/4"
 19770-01 48x 90 mm
 19770-02 48x105 mm
 19770-03 48x120 mm
 19770-04 48x135 mm
 19770-05 48x155 mm

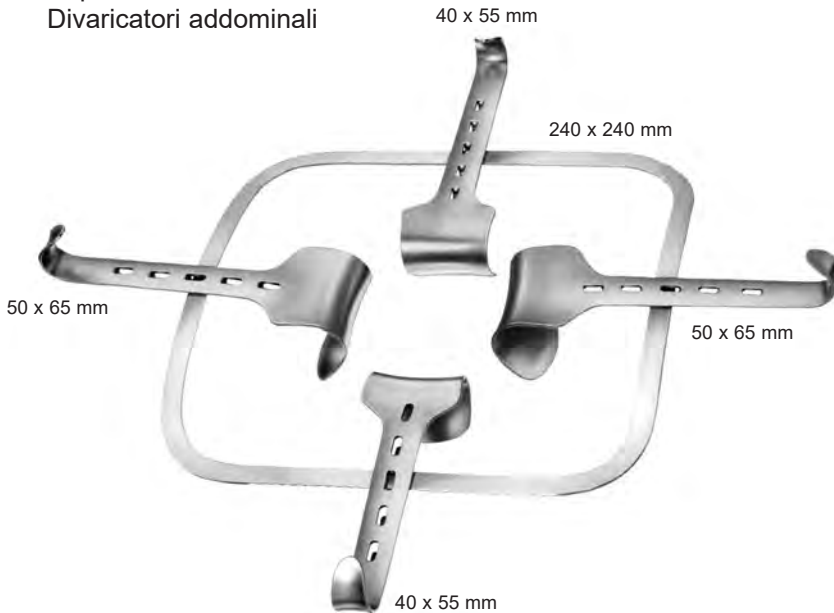


19790-01



19790-02

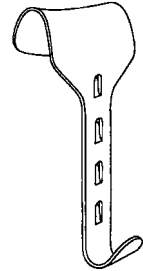
Bauchdeckenhalter
Abdominal Retractors
Separadores abdominales
Divaricatori addominali



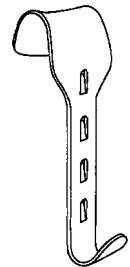
KIRSCHNER

19782-00 Kirschner Bauchdeckenhalter komplett bestehend aus:
Kirschner Abdominal Retr. complete consisting of:
Kirschner separador abdominal completo compuesto de:
Kirschner Divaricatore addominale completo, composto da:

- 1 x 19781-55 Rahmenhaken / Hook-on Retr. / separadores / divaricatori 40 x 55 mm
- 1 x 19781-65 Rahmenhaken / Hook-on Retr. / separadores / divaricatori 50 x 65 mm
- 1 x 19783-24 Rahmen fest / frame rigid / marco rigido / telaio rigido 240 x 240 mm



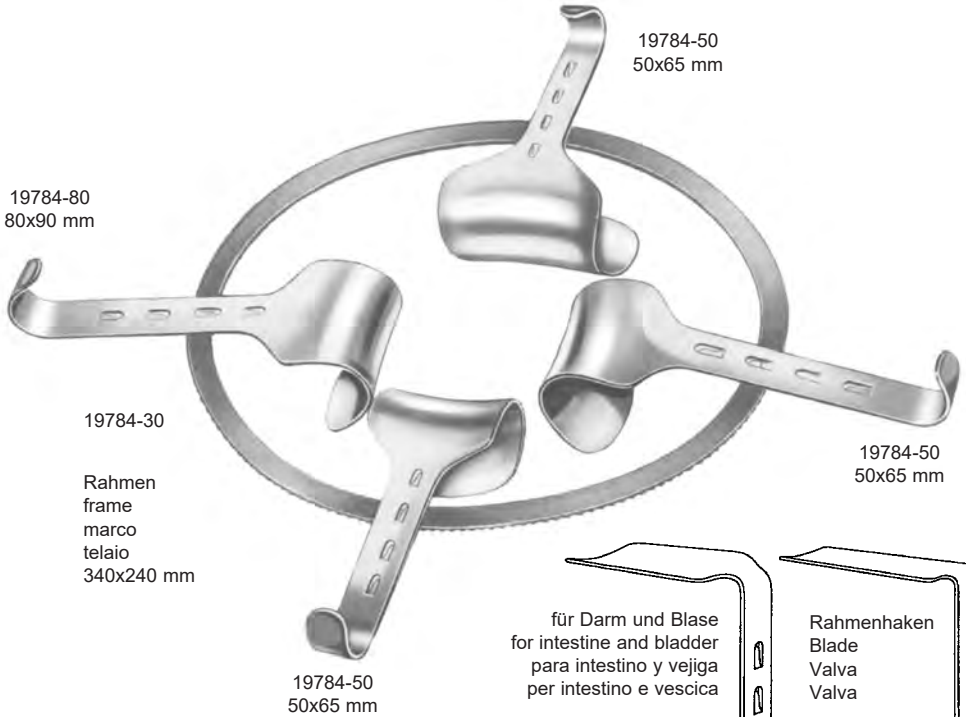
19781-55
40 x 55 mm breit



19781-65
50 x 65 mm breit

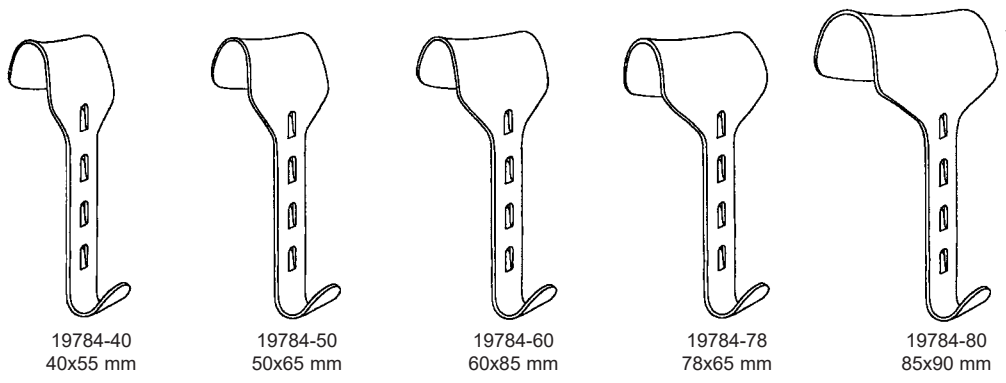
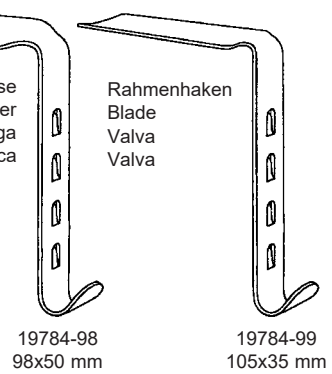


Bauchdeckenhalter
Abdominal Retractors
Separadores abdominales
Divaricatori addominali



19784-00 KIRSCHNER Bauchdeckenhalter komplett bestehend aus:
KIRSCHNER Abdominal Retr. complete consisting of:
KIRSCHNER separador abdominal completo compuesto de:
KIRSCHNER Divaricatore addominale completo, composto da:

- 1 x 19784-30 Rahmen fest / frame rigid / marco rigido / telaio rigido 340 x 240 mm
- 1 x 19784-50 Rahmenhaken / Hook-on Retr. / separadores / divaricatori 50 x 65 mm
- 1 x 19784-80 Rahmenhaken / Hook-on Retr. / separadores / divaricatori 80 x 90 mm
- 1 x 19784-98 Rahmenhaken / Hook-on Retr. / separadores / divaricatori 98 x 50 mm
- 1 x 19784-99 Rahmenhaken / Hook-on Retr. / separadores / divaricatori 105 x 35 mm



Arm System
 Arm System
 Sistema de brazo
 Sistema braccio



19795-01
 Armsystem Radius 310/420 mm komplett mit Wundhakenhalter und L-Stativ Ø 16 mm, 400 mm hoch, 400 mm breit, 170 mm tief (ohne Klemmsockel).
 Arm System, radius 310/420 mm, including retractor and L-stand Ø 16 mm, 400 mm high, 400 mm wide, 170 mm deep (without clamp socket).



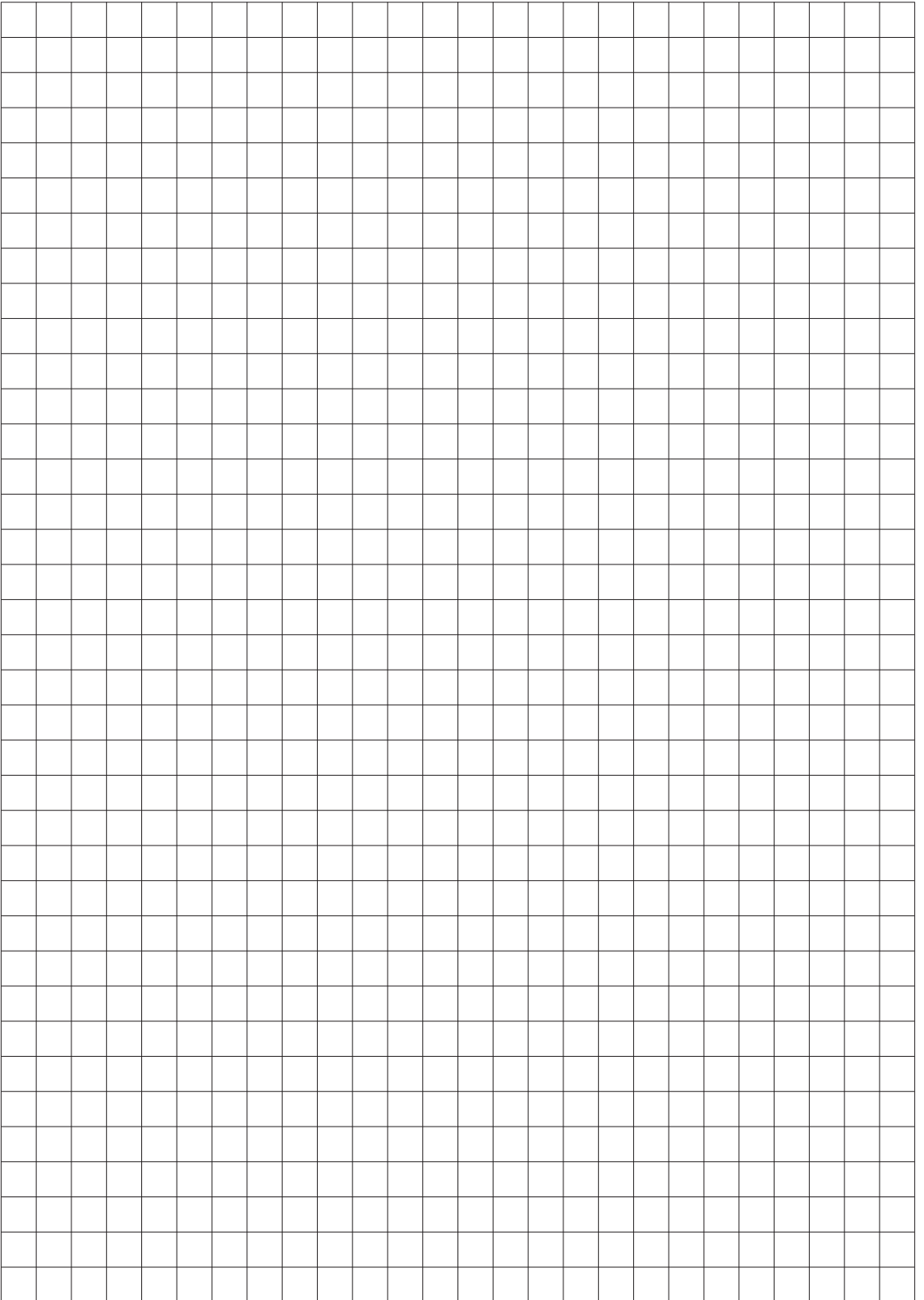
19795-02
 Armsystem Radius 310/420 mm komplett mit Stativ, und Endoskophalter Ø 8/10 mm. (ohne Klemmsockel).
 Arm System, radius 310/420 mm, including stand, endoscope holder Ø 8/10 mm. (without clamp socket).



19798-02
 Endoskophalter Universal
 Ø 3-10 mm
 Endoscope holder Universal
 Ø 3-10 mm



19799-05
 Klemmsockel aus rostfreiem Stahl, für ein höhenverstellbares Stativ Ø 16 mm, elektrisch isoliert bis 4,5 kV AC, Spannweite 50 mm für Schienen 25/32 x 8/12 mm.
 Clamp socket made of stainless steel, for height-adjustable stand Ø 16 mm, electrically insulated up to 4.5 kV AC, holding width of 50 mm for rails 25/32 x 8/12 mm.



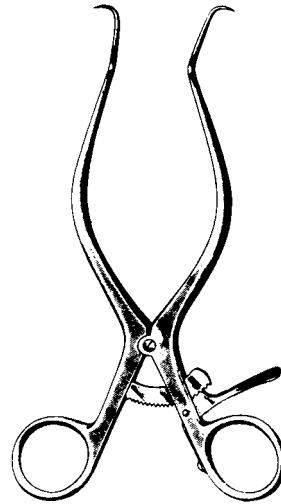
Bauchdeckenhalter, Wundsperrer
 Abdominal Retractors, Retractors
 Separadores abdominales, Separadores
 Divaricatori addominali, Divaricatori



DOYEN

28 cm, 11"

19800-01 48x 90 mm
 19800-02 48x105 mm
 19800-03 48x120 mm
 19800-04 48x135 mm



GELPI

19802-09 9 cm, 3 1/2"
 19802-11 11 cm, 4 3/8"
 19802-14 14 cm, 5 1/2"
 19802-16 16 cm, 6 1/4"
 19802-18 18 cm, 7"

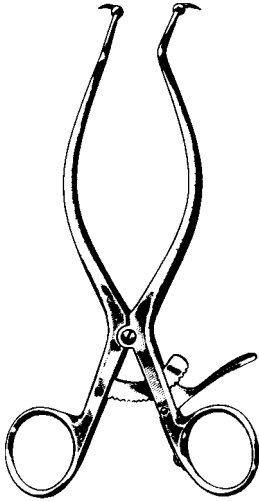


DE BAKEY

19803-14

14,5 cm, 5 3/4"

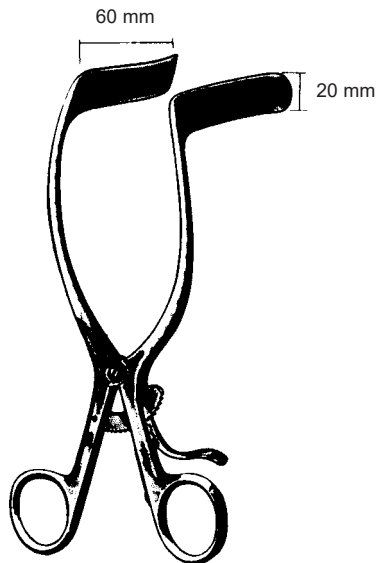
Wundsperrer
Retractors
Separadores
Divaricatori



GELPI
19804-18
18 cm, 7"



JACKSON BURROWS
19805-18 18,5 cm, 7 1/4"
19805-28 28 cm, 11"

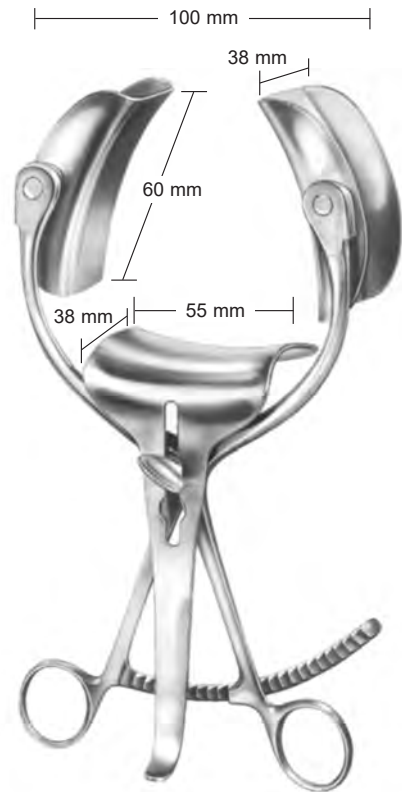


RIGBY
19806-18
18 cm, 7"

Bauchdeckenhalter
Abdominal Retractors
Separadores abdominales
Divaricatori addominali

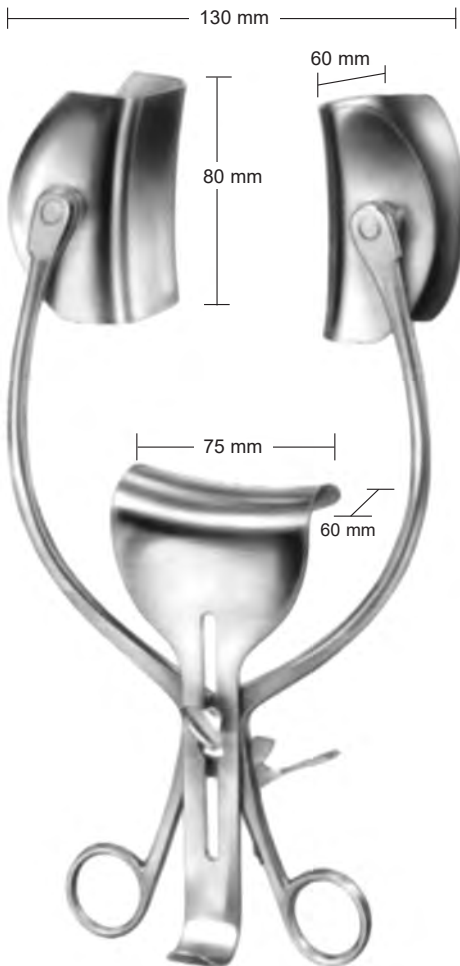


COLLIN
19810-22
komplett
complete
completo

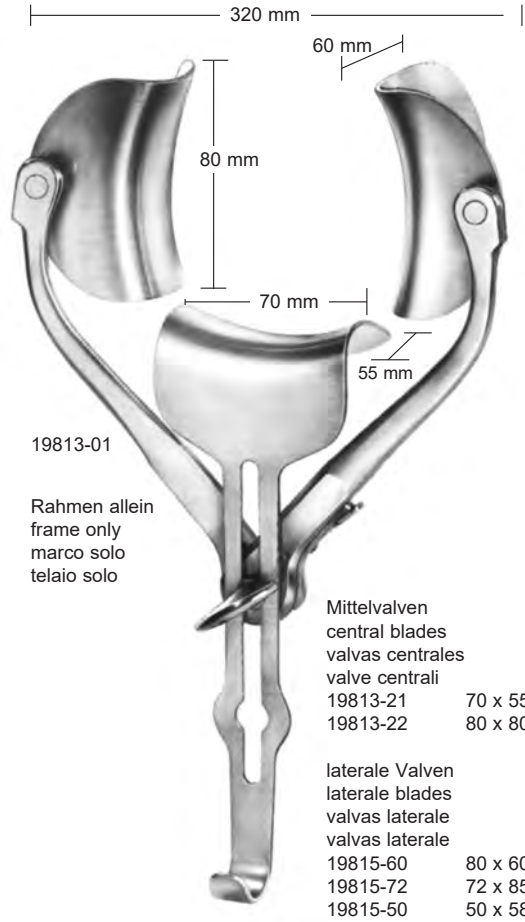


COLLIN
19812-60
komplett
complete
completo

Bauchdeckenhalter
Abdominal Retractors
Separadores abdominales
Divaricatori addominali



COLLIN Loktite
19816-00 31 cm, 12 1/4"
komplett / complete / completo



19813-01

Rahmen allein
frame only
marco solo
telaio solo

Mittelvalven
central blades
valvas centrales
valve centrali

19813-21	70 x 55 mm
19813-22	80 x 80 mm

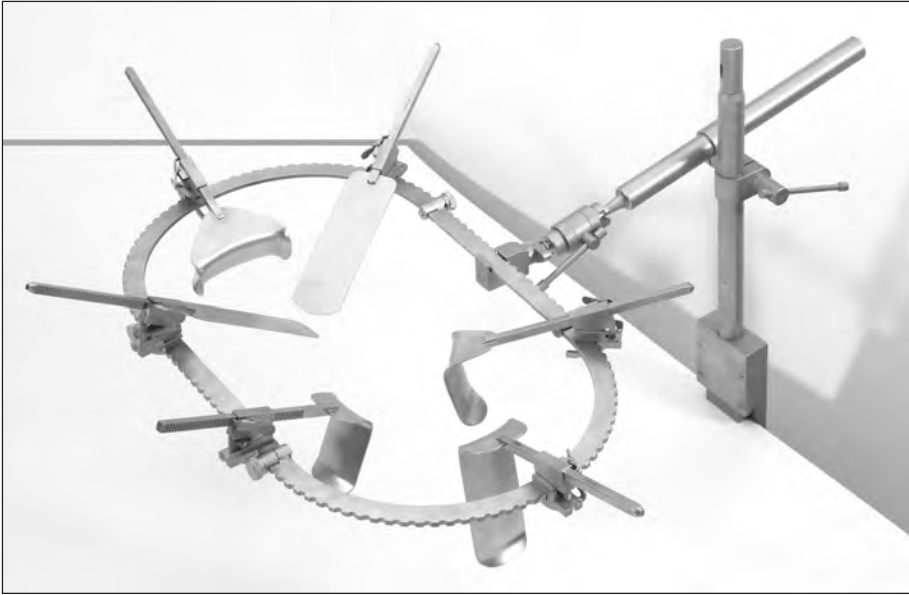
laterale Valven
laterale blades
valvas laterale
valvas laterale

19815-60	80 x 60 mm
19815-72	72 x 85 mm
19815-50	50 x 58 mm

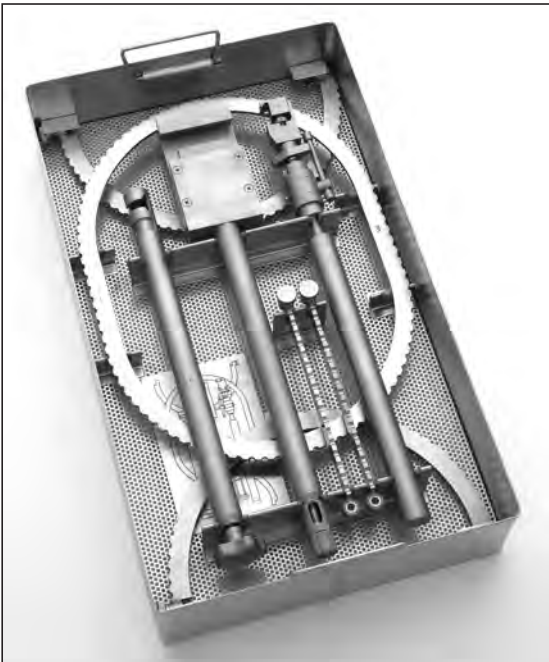
RICARD

19813-00 30 cm, 11 3/4"
komplett / complete / completo

Back holder Abdominal Retractor
Operation Table Set



Complete Fixed Abdominal Retractor Set
Set completo divaricatore addominale con sistema di montaggio modulare



The many components of the **Back holder Abdominal Retractor Operation Table Set** can all be neatly arranged into autoclave sized containers with diagrams that direct instrument handlers on proper placement of each component.

A major convenience in care and maintenance of the Retractor Set

Sterilization Container & Baskets

Description	Product No
Table Fixation & Ring Case	19820-90
Blade & Accessories Case	19820-91

**Back holder Abdominal Retractor
Operation Table Set**

Description	Product No	Composto da	
Complete Abdominal Retractor Set	19820-99	Accoppiatore	19821-01
		Barra orizzontale	19821-02
Includes		Morsetto di accoppiamento	19821-04
Table Post	19821-01	Anello ovale	19820-02
Horizontal Bar	19821-02	No. 2 retrattori malleabili, 51x152 mm	19825-06
1" Post Coupling	19821-04	No. 2 Valve Kelly, dim. 51x76 mm	19822-23
Oval Ring	19820-02	Valva Kelly	19822-24
2" X 6" Malleable Retractor (2 ea)	19825-06	Valva Balfour	19823-33
2" X 3" Kelly Retractor (2 ea)	19822-23	Morsetto trasportabile con trasporto ad intervallo progressivo di 2 mm	19820-10
2" X 4" Kelly Retractor	19822-24	Morsetto articolato multidisciplinare con funzione movimento assiale orizzontale e verticale	19820-20
Balfour Retractor	19833-33	Anello ovale 266x367 mm	19820-02
Ratchet Mechanism (2 ea)	19820-10	Anello a segmento 266x495 mm	19820-03
Tilt Ratchet Mechanism (6 ea)	19820-20	Retrattore malleabile 38x152 mm	19824-06
Oval Ring	19820-02	Retrattore malleabile 76x152 mm	19826-06
Segmented Ring	19820-03	Valva Kelly, 51x127 mm	19822-25
1 1/2" X 6" Malleable Retractor	19824-06	Valva Kelly, 51x152 mm	19822-26
3" x 6" Malleable Retractor	19826-06	Barra flessibile orizzontale	19821-03
2" X 5" Kelly Retractor	19822-25	Retrattore Harrington 63x143 mm	19831-25
2" X 6" Kelly Retractor	19822-26	Retrattore con punta Gelpi	19834-01
Horizontal Flex Bar	19821-03		
Harrington Retractor	19831-25		
Gelpi Retractor	19834-01		
Accessories		Accessori:	
Table Fixation & Ring Case	19820-90	Container vuoto in acciaio inox dotato con griglia interna	
Blades & Accessories Case	19820-91	Descrizione	
		Container in acciaio inox dotato di griglia interna per Accessori di fissazione, anelli e barre	19820-90
		Container in acciaio inox dotato di griglia interna per morsetti e divaricatori	19820-91



Malleable Retractors with Protective Edge



Description	Product No
1½" x 6" 38 x 152 mm	19824-06
2" x 6" 51 x 152 mm	19825-06
3" x 6" 76 x 152 mm	19826-06

Specialty Retractors

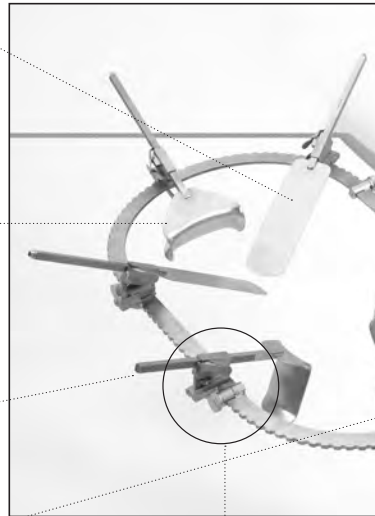
Description	Product No
Balfour Retractor 2 ⁵ / ₈ " x 3" 67 x 76 mm	19833-33
Gelpi Point Retractor	19834-01



Harrington Retractors

Description Product No

Blade 2.5" x 5⁵/₈" 19831-25
63 x 143 mm



Description	Product No
Blade 2" x 1½" 51 x 38 mm	19822-21
Blade 2" x 2" 51 x 51 mm	19822-22
Blade 2" x 2½" 51 x 64 mm	19822-22L
Blade 2" x 3" 51 x 76 mm	19822-23
Blade 2" x 4" 51 x 102 mm	19822-24
Blade 2" x 5" 51 x 127 mm	19822-25
Blade 2" x 6" 51 x 152 mm	19822-26



Description	Product No
Blade 1" x 1½" 25 x 38 mm	19822-01
Blade 1" x 2½" 25 x 63 mm	19822-02



Tilt Ratchet Mechanism allows extensions or retractions along the horizontal axis and allows vertical movement of retractor blade with a second ratchet

Product No 19820-20

Table Mounting Components

Description **Product No**
 1" Post Coupler 19821-04

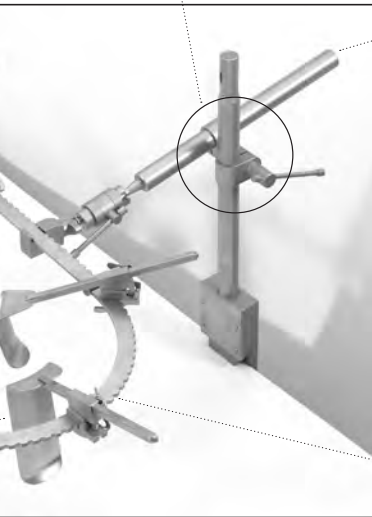
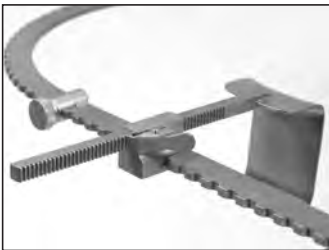


Table Mounting Components

Table Post	19821-01	300 mm
Horizontal Bar	19821-02	420 mm
Horizontal Flex Bar	19821-03	470 mm



Fixed Ratchet Mechanism allows extension or retraction along the horizontal axis at 2mm intervals

Product No 19820-10



Retractor Rings

Description	Product No
Oval Ring 10.5 x 14.5 inch / 266 x 367 mm	19820-02
Segmented Ring 10.5 x 19.5 inch / 266 x 495 mm	19820-03
(Consists of one 10.5 inch Round Ring and two 8 inch straight segments)	

Laminektomiespreizer
Laminectomy Retractors
Separadores para laminectomia
Divaricatori per laminectomia



SCOVILLE-HAVERFIELD
19910-00
Rahmen allein
Frame only
Marco solo
Telaio solo



SCOVILLE
19911-00
Rahmen allein
Frame only
Marco solo
Telaio solo



SCOVILLE
50 mm, 2"
19912-50



SCOVILLE
70 mm, 2 3/4"
19912-70



SCOVILLE
19914-41 41 x 38 mm
19914-67 67 x 44 mm



TAYLOR
19915-48 48 x 50 mm
19915-64 64 x 50 mm
19916-64 64 x 64 mm
19916-80 80 x 57 mm



SCOVILLE
50 mm, 2"
19913-50



SCOVILLE
70 mm, 2 3/4"
19913-70



SCOVILLE
19917-64 64 x 25 mm
19918-64 64 x 50 mm
19918-88 88 x 25 mm

Wundhaken für plastische Chirurgie
 Retractors for plastic surgery
 Separadores para cirugía plástica
 Divaricatore per chirurgia plastica



mit Kaltlicht + Absaugung
 with cold light + aspiration
 con luz fria + aspiracion
 con luce fredda + aspirazione

TEBBETS

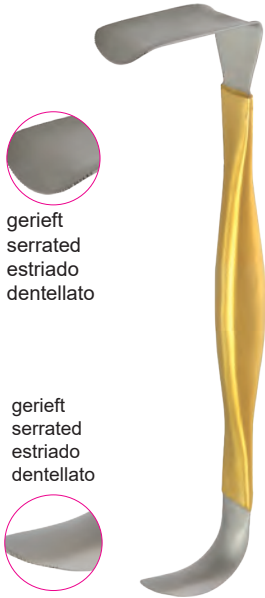
19980-01	80 mm x 16 mm
19980-02	100 mm x 25 mm
19980-03	120 mm x 25 mm
19980-04	120 mm x 30 mm
19980-05	150 mm x 25 mm
19980-06	150 mm x 30 mm



FERRIERA

19960-01	80 mm x 16 mm
19960-02	100 mm x 25 mm
19960-03	120 mm x 25 mm
19960-04	120 mm x 30 mm
19960-05	150 mm x 25 mm
19960-06	150 mm x 30 mm

Wundhaken für plastische Chirurgie
 Retractors for plastic surgery
 Separadores para cirugía plástica
 Divaricatore per chirurgia plastica



gerieft
 serrated
 estriado
 dentellato

gerieft
 serrated
 estriado
 dentellato



CORONAL
 19980-18
 18 cm, 7"



YANCOSKIE
 19990-18
 18 cm, 7"

BREAST

19970-23	23,0 cm, 9"	34 x 100 mm, 20 x 60 mm
19970-24	24,0 cm, 9 1/2"	38 x 70 mm, 22 x 55 mm
19970-01	31,5 cm, 12 1/2"	38 x 70 mm, 20 x 55 mm



FREEMAN

19995-38 18 cm, 7"
 38 mm, 1 1/2" wide
 19995-22 18 cm, 7"
 22 mm, 7/8" wide



ANDERSON

19998-03 12 cm, 4 3/4" 3 Zähne
 3 prongs
 3 dientes
 3 uncini
 19998-05 12 cm, 4 3/4" 5 Zähne
 5 prongs
 5 dientes
 5 uncini

Sonden
 Probes, Directors
 Sondas, estiletos
 Sonde, specilli



2 mm ø

- 11,5 cm, 4 1/2" 21102-11
- 13,0 cm, 5 1/8" 21102-13
- 14,5 cm, 5 3/4" 21102-14
- 16,0 cm, 6 1/4" 21102-16
- 18,0 cm, 7" 21102-18
- 20,0 cm, 8" 21102-20
- 25,0 cm, 10" 21102-25



1 mm ø

- 21104-11
- 21104-13
- 21104-14
- 21104-16
- 21104-18
- 21104-20
- 21104-25



2 mm ø

- 21106-11
- 21106-13
- 21106-14
- 21106-16
- 21106-18
- 21106-20
- 21106-25



21108-14
 14,5 cm, 5 3/4"



BRODIE
 21109-18
 18 cm
 7"



- 13,0 cm, 5 1/8" 21110-13
- 14,5 cm, 5 3/4" 21110-14
- 16,0 cm, 6 1/4" 21110-16
- 18,0 cm, 7" 21110-18
- 20,0 cm, 8" 21110-20



DOYEN
 21111-14
 14 cm
 5 1/2"



21112-14
 14,5 cm
 5 3/4"



NELATON
 21120-16
 16 cm
 6 1/4"



FISH
 21121-14
 14 cm, 5 1/2"
 21121-18
 18 cm, 7"



WATSON-CHEYNE
 21122-13
 13 cm, 5 1/8"
 21122-18
 18 cm, 7"

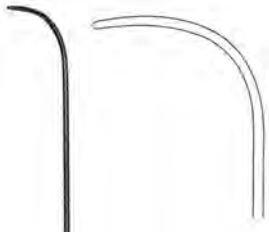
Fistelsonden
Fistula Probes
Sondas para fistula
Sonde per fistole



LOCKHART-MUMMERY
21125-01
16,5 cm, 6 1/2"



LOCKHART-MUMMERY
21125-02
16,5 cm, 6 1/2"

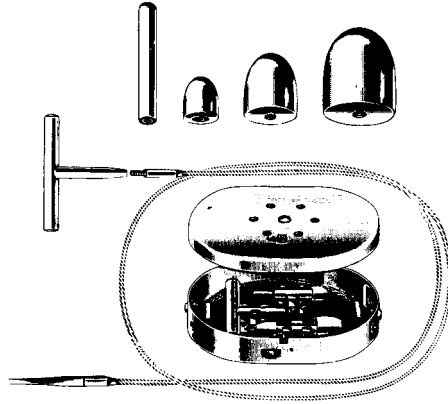


LOCKHART-MUMMERY
21125-03
16,5 cm, 6 1/2"



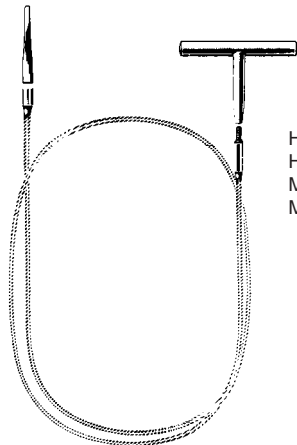
LOCKHART-MUMMERY
21125-04
16,5 cm, 6 1/2"

Krampfader-Besteck in Metalletui
 Varicose vein probe set in metal case
 Juego para várices en estuche de metal
 Astuccio per varici in scatola di metallo



NABATOFF
 21150-00
 135x100x25 mm
 compl.

21150-02
 Sondenspitze
 Probe Tip
 Puntas sueltas
 Punte

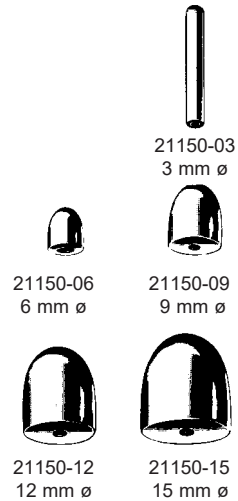


21150-80
 Handgriff
 Handle only
 Mango suelto
 Manico solo

21150-90

Zugseil
 cable flexible
 cable de traccion flex.
 Corda di trazione fless.

Oliven
 Olives
 Olivas
 Olivas



21150-03
 3 mm ø

21150-06
 6 mm ø

21150-09
 9 mm ø

21150-12
 12 mm ø

21150-15
 15 mm ø

Varizeninstrumente
 Varix Instruments
 Instrumentos para varices
 Strumenti per varici



VARADY
 21154-01
 180 mm, 7"



VARADY
 21154-02
 180 mm, 7"



VARADY
 21154-03
 180 mm, 7"



VARADY
 21154-04
 175 mm, 6.9"

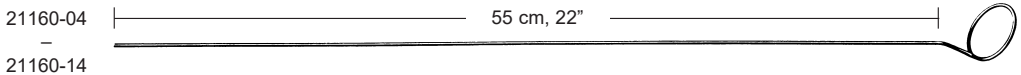


VARADY
 21154-05
 170 mm, 6 3/4"



VARADY
 21154-06
 170 mm, 6 3/4"

21162-12
 12 cm, 4 3/4"
 Griff
 Handle
 Mango
 Manico



21160-04
 -
 21160-14



21160-04
 4 mm ø



21160-06
 6 mm ø



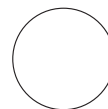
21160-07
 7 mm ø



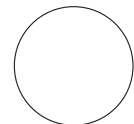
21160-08
 8 mm ø



21160-10
 10 mm ø



21160-12
 12 mm ø



21160-14
 14 mm ø

Watteträger, Spatel
Cotton Applicators, Spatulas
Porta-algodones, Espátulas
Portacotone, Spatole



FARRELL

4 3/4"	21270-12	12,0 cm
5 1/2"	21270-14	14,0 cm
6 1/4"	21270-16	16,5 cm
7"	21270-18	18,0 cm
9"	21270-23	23,0 cm
12"	21270-30	30,0 cm



FARRELL

4 3/4"	21272-12	12,0 cm
5 1/2"	21272-14	14,0 cm
6 1/4"	21272-16	16,5 cm
7"	21272-18	18,0 cm
9"	21272-23	23,0 cm



REDA

4 3/4"	21290-12	12,0 cm
5 1/2"	21290-14	14,0 cm
6 1/4"	21290-16	16,0 cm
7"	21290-18	18,0 cm



1,5



1,5

REDA

4 3/4"	21292-12	12,0 cm
5 1/2"	21292-14	14,0 cm
6 1/4"	21292-16	16,0 cm
7"	21292-18	18,0 cm

Spatel
Plaster spatula
Espátula
Spatole



21190-14
14,5 cm, 5 3/4"



UCKERMANN
21310-15
15 cm, 6"

ø 3 mm

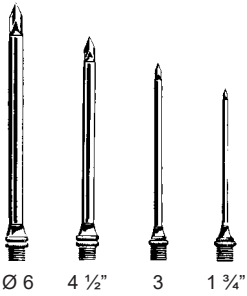


JOBSON-HORNE
21320-12 12 cm, 4 3/4"
21320-18 18 cm, 7"



TOBOLD
21331-25
25 cm, 10"

Trokare
Trocars
Trócares
Trequarti



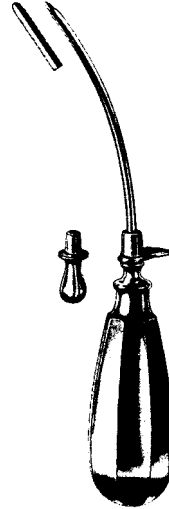
Ø 6 4 ½" 3 1 ¾"



UNIVERSAL
23104-00
compl.



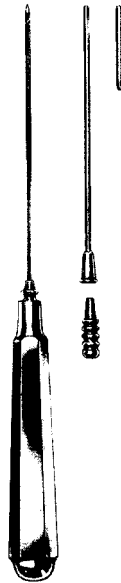
STANDARD (NELSON)
23110-30 3,0 mm ø
23110-35 3,5 mm ø
23110-40 4,0 mm ø
23110-45 4,5 mm ø
23110-50 5,0 mm ø
23110-55 5,5 mm ø
23110-60 6,0 mm ø



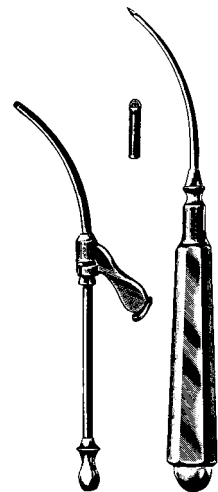
PIERCE
23123-30 3,0 mm ø
23123-40 4,0 mm ø



DOUGLAS
23125-11 3 mm Ø



LICHTWITZ
23128-19 1,75 mm Ø



COAKLEY
23140-02 2,25 mm Ø

Trokare
Trocars
Trócares
Trequarti



Charr./	F.G.	OCHSNER
10	23150-10	
12	23150-12	
14	23150-14	
16	23150-16	
18	23150-18	
20	23150-20	



Charr./	F.G.	NELSON	∅
25	23170-25		7,5 mm
30	23170-30		9,0 mm
33	23170-33		10,5 mm
35	23170-35		12,0 mm



SINOSKOPIE-TROKAR
8,5 cm, 3,4"

23181-40 f. Optik mit Ø 4,0 mm

Biopsiekanülen
 Biopsy Needles
 Agujas para biopsia
 Aghi per biopsia

Nadelführer
 Pudendus
 Anesthesie
 anestesia



IOWA
 23210-00
 14 cm, 5 1/2"
 compl.



MENGHINI

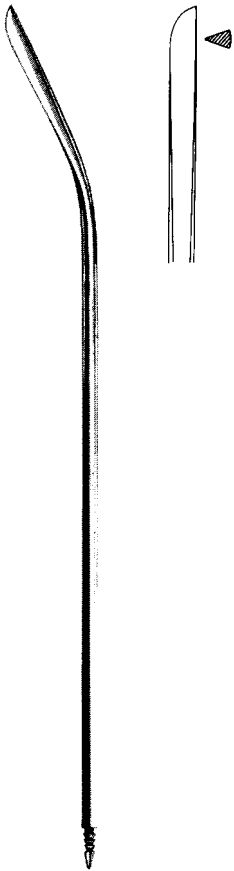
23302-01	1,0x 35 mm
23302-02	1,0x 70 mm
23302-03	1,2x 70 mm
23302-04	1,2x100 mm
23302-05	1,4x 70 mm
23302-06	1,4x100 mm
23302-07	1,6x 70 mm
23302-08	1,8x100 mm



MENGHINI

23310-14	1,4x168 mm
23310-18	1,8x168 mm

Führungsnadeln
 Guide needles
 Aguja de Guía
 Ago guida

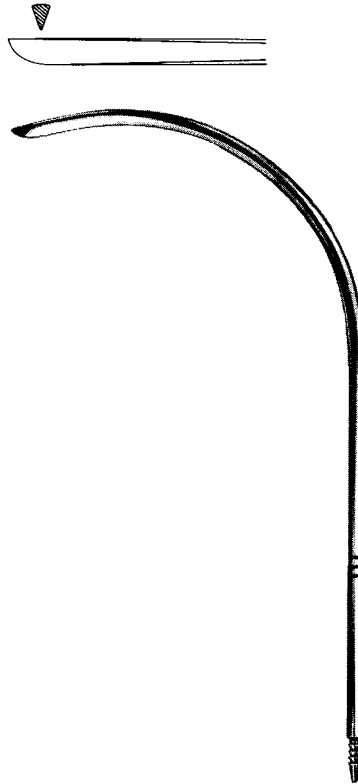


REDON
 23195-08 - 23195-18

Messerspitze, gerade
 Guide Needle, straight
 Aguja de guía, recta
 Ago guida, retta

Charr./Fr.

8	23195-08
10	23195-10
12	23195-12
14	23195-14
16	23195-16
18	23195-18

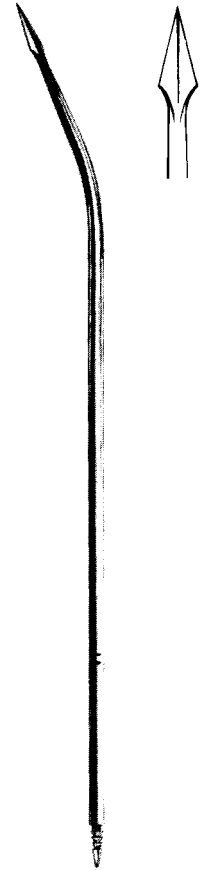


REDON
 23197-08 - 23197-18

Messerspitze, gebogen
 Guide Needle, curved
 Aguja de guía, curva
 Ago guida, curva

Charr./Fr.

8	23197-08
10	23197-10
12	23197-12
14	23197-14
16	23197-16
18	23197-18



REDON
 23198-08 - 23198-18

Lanzettspitze, gerade
 Lancet tip, straight
 Punta lanceolar, recta
 Punta lanceolata, retta

Charr./Fr.

8	23198-08
10	23198-10
12	23198-12
14	23198-14
16	23198-16
18	23198-18

Nadelhalter
Needle Holders
Porta-agujas
Port'aghi



DERF

25110-12 12 cm, 4 3/4"

25114-12 TC 12 cm, 4 3/4"



DERF

25120-12 12,5 cm, 5"



COLLIER

25122-12 12,5 cm, 5"



glatt
smooth
lisa
liscia

WEBSTER

25128-13 13 cm, 5 1/8"

25129-13 TC 13 cm, 5 1/8"

BABY-WEBSTER

25136-11 11 cm, 4 3/8"

25137-11 TC 11 cm, 4 3/8"

25138-11 TC 11 cm, 4 3/8"

gerieft/serrated
estriada/zigrinato



HALSEY

25130-13 25140-13

25134-13 TC 25144-13 TC

13 cm, 5 1/8"



NEIVERT

25146-13 25148-13 TC

13 cm, 5 1/8"



BAUMGARTNER

25150-12 25154-12 TC

12,5 cm, 5"

25150-14 25154-14 TC

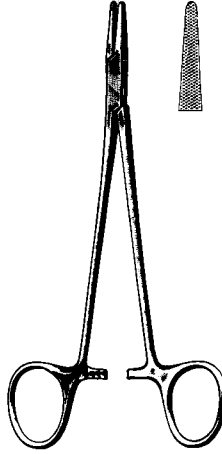
14,0 cm, 5 1/2"

Nadelhalter
Needle Holders
Porta-agujas
Port'aghi



CRILE-WOOD

25160-15	15 cm, 6"	25164-15 TC
25160-18	18 cm, 7"	25164-18 TC
25160-20	20 cm, 8"	25164-20 TC
25160-23	23 cm, 9"	25164-23 TC



CRILE-MURRAY

25170-15	15 cm, 6"	25174-15 TC
----------	-----------	-------------



MAYO-HEGAR

25180-12	12 cm, 4 3/4"	25184-12 TC
25180-14	14 cm, 5 1/2"	25184-14 TC
25180-16	16 cm, 6 1/4"	25184-16 TC
25180-18	18 cm, 7"	25184-18 TC
25180-20	20 cm, 8"	25184-20 TC
25180-24	24 cm, 9 1/2"	25184-24 TC
25180-26	26 cm, 10 1/4"	25184-26 TC
25180-30	30 cm, 11 3/4"	25184-30 TC



fein
fine
delicate
fino

MAYO-HEGAR

25190-16	16 cm, 6 1/4"	25194-16 TC
25190-18	18 cm, 7"	25194-18 TC
25190-20	20 cm, 8"	25194-20 TC



BROWN

25196-13	13 cm, 5 1/8"
25196-18	18 cm, 7"

Nadelhalter
Needle Holders
Porta-agujas
Port'aghi



DE BAKEY

25214-16 TC	16 cm, 6 ¹ / ₄ "
25214-18 TC	18 cm, 7"
25214-20 TC	20 cm, 8"
25214-23 TC	23 cm, 9"
25214-26 TC	26 cm, 10 ¹ / ₄ "
25214-31 TC	31 cm, 12 ¹ / ₄ "

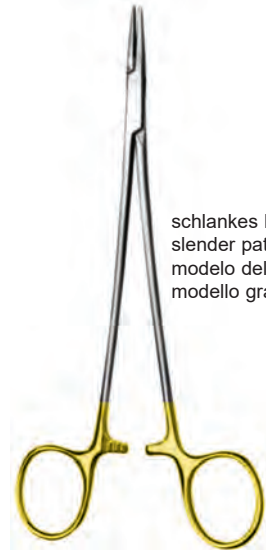


RYDER 1 mm

25224-13 TC	13 cm, 5 ¹ / ₈ "
25224-15 TC	15 cm, 6"
25224-18 TC	18 cm, 7"
25224-20 TC	20 cm, 8"
25224-23 TC	23 cm, 9"
25224-26 TC	26 cm, 10 ¹ / ₄ "

RYDER 2 mm

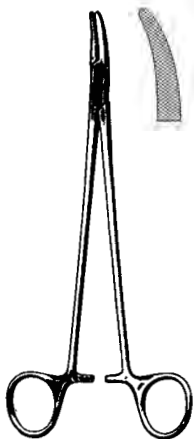
25225-13 TC	
25225-15 TC	
25225-18 TC	
25225-20 TC	
25225-23 TC	
25225-26 TC	



schlankes Modell
slender pattern
modelo delgado
modello gracile

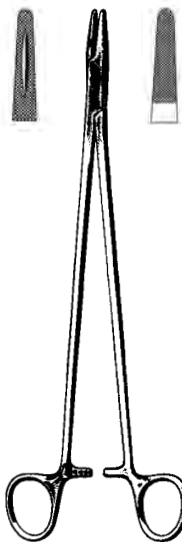
MICROVASCULAR

25230-18 TC	18 cm, 7"
25230-20 TC	20 cm, 8"
25230-23 TC	23 cm, 9"



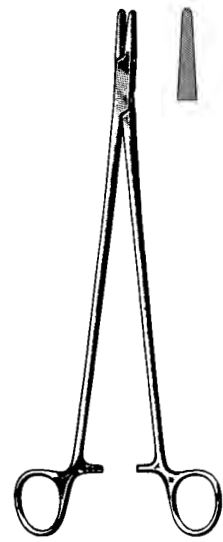
HEANEY

25241-21	21 cm, 8 ¹ / ₄ "
25241-26	26 cm, 10 ¹ / ₄ "
25245-21 TC	21 cm, 8 ¹ / ₄ "
25245-26 TC	26 cm, 10 ¹ / ₄ "



MASSON

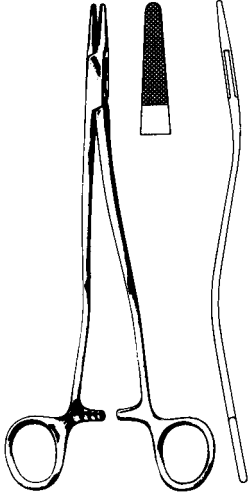
25250-27	27 cm, 10 ¹ / ₂ "
25254-27 TC	27 cm, 10 ¹ / ₂ "



WANGENSTEEN

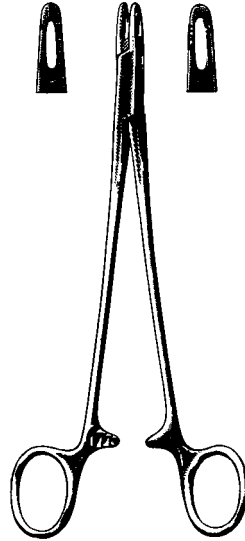
25260-27	27 cm, 10 ¹ / ₂ "
25264-27 TC	27 cm, 10 ¹ / ₂ "

Nadelhalter
Needle Holders
Porta-agujas
Port'aghi



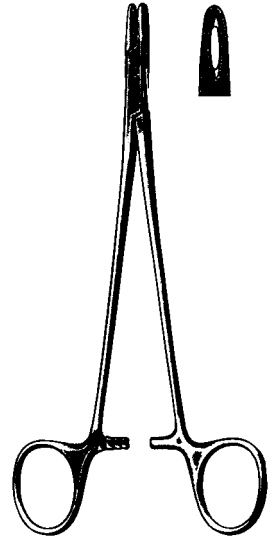
BOZEMANN

25285-20 TC 20 cm, 8"
25285-24 TC 24 cm, 9½"
25285-26 TC 26 cm, 10¼"



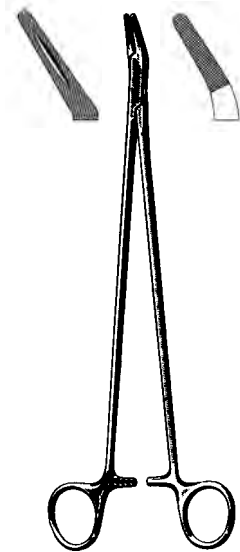
METZENBAUM

25290-18
18 cm, 7"



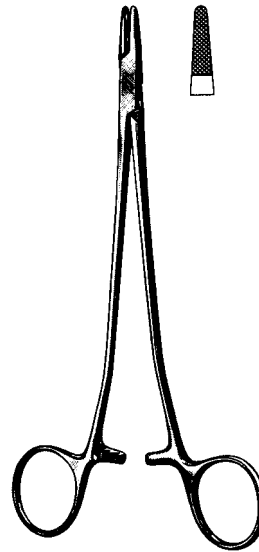
ADSON

25292-18
18 cm, 7"



FINOCHIETTO

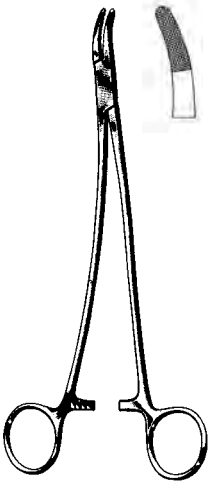
25311-20 20 cm, 8"
25311-27 27 cm, 10½"



SAROT

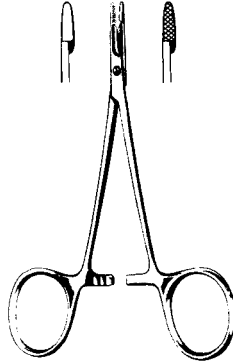
25324-18 TC 18 cm, 7"
25324-26 TC 26 cm, 10¼"

Nadelhalter
Needle Holders
Porta-agujas
Port'aghi



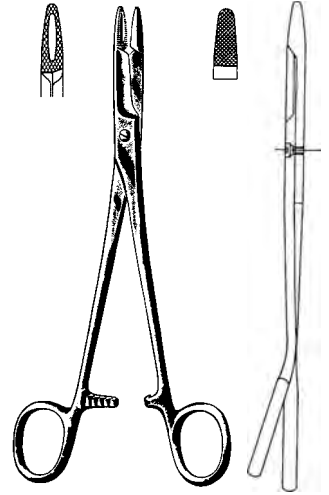
STRATTE

25330-21 21 cm, 8¹/₄"
25330-23 23 cm, 9" **25334-23 TC**



BABY-OLSEN-HEGAR

25405-12 25406-12
25408-12 TC 25407-12 TC
11,5 cm, 4¹/₂"



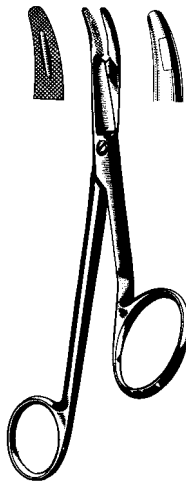
OLSEN-HEGAR

25410-14 14 cm, 5¹/₂" **25414-14 TC**
25410-17 17 cm, 6³/₄" **25414-17 TC**
18 cm, 7" **25414-18 TC**



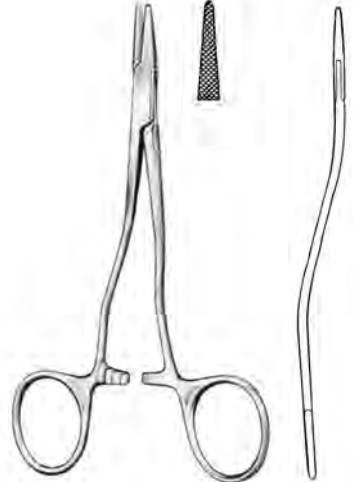
MATHIEU-OLSEN

25415-14 TC 14 cm, 5¹/₂"
25415-17 TC 17 cm, 6³/₄"
25415-20 TC 20 cm, 8"



GILLIES

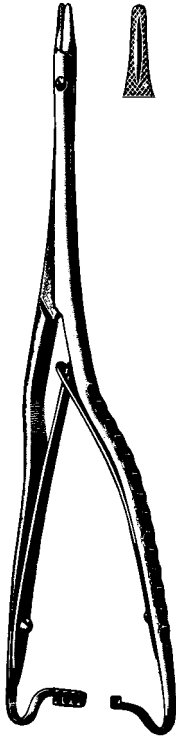
11 cm, 4³/₈" **25434-11 TC**
13 cm, 5¹/₈" **25434-13 TC**
25430-16 16 cm, 6¹/₄" **25434-16 TC**



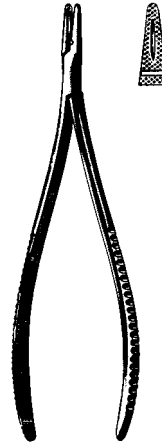
KILNER

25436-13 13 cm, 5¹/₈"
25438-13 TC 13 cm, 5¹/₈"

Nadelhalter
Needle Holders
Porta-agujas
Port'aghi



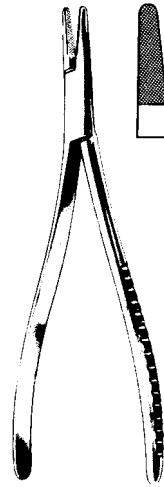
HOESEL
25446-25 25 cm, 10"
25447-25 TC 25 cm, 10"



CRILE
25438-15 15 cm, 6"



MATHIEU
25450-14 14 cm, 5½" 25452-14 TC
25450-17 17 cm, 6¾" 25452-17 TC
25450-20 20 cm, 8" 25452-20 TC
25450-24 24 cm, 9½" 25452-24 TC



LANGENBECK
25460-18 TC 18 cm, 7"
25460-20 TC 20 cm, 8"
25460-23 TC 23 cm, 9"

Nadelhalter
Needle Holders
Porta-agujas
Port'aghi

Oftalmologie
Ophthalmology
Oftalmologia
Oftalmologia



STEVENS
25610-11
11 cm, 4³/₈"



STEVENS
25612-15
15 cm, 6"



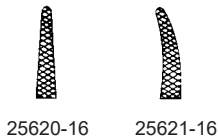
BOYNTON
25614-12
12 cm, 4³/₄"



BOYNTON
25615-12 TC
12 cm, 4³/₄"



ARRUGA
25620-16 - 25624-16
16 cm, 6¹/₄"



25620-16



25621-16



25624-16 TC **25625-16 TC**



KALT-ARRUGA
25627-14
14 cm, 5¹/₂"



KALT
25628-14
14 cm, 5¹/₂"

Nadelhalter
Needle Holders
Porta-agujas
Port'aghi



JACOBSEN
25667-18 18 cm, 7"
25668-18 TC 18 cm, 7"
25667-21 21 cm, 8 1/4"
25668-21 TC 21 cm, 8 1/4"



CASTROVIEJO
14 cm, 5 1/2"



25670-14
glatt
smooth
lisa
liscia



25672-14
gerieft
serrated
estriada
zigrinato



25676-14 TC



25671-14
glatt
smooth
lisa
liscia



25673-14
gerieft
serrated
estriada
zigrinato



25677-14 TC



25678-09



25679-09



CASTROVIEJO-MICRO
9 cm, 3 1/2"



CASTROVIEJO
25680-13 13 cm, 5 1/8"
25684-13 TC 13 cm, 5 1/8"

Mikro-Nadelhalter
 Micro-Needle Holders
 Micro-Porta-agujas
 Micro-Port'aghi



CASTROVIEJO-STANDARD
 25678-14 14 cm, 5 1/2"

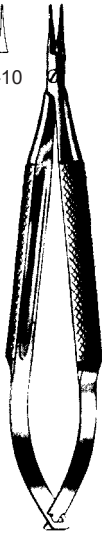


CASTROVIEJO-STANDARD
 25679-14 14 cm, 5 1/2"



25650-10

25651-10



BARRAQUER
 10 cm, 4"



25656-10

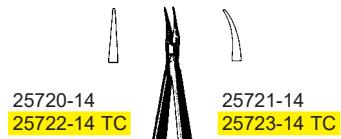
25657-10

BARRAQUER-TROUTMAN
 10 cm, 4"

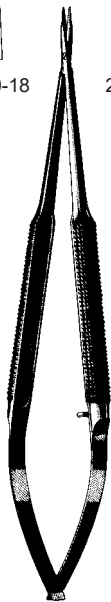
Mikro-Nadelhalter
Micro-Needle Holders
Micro-Porta-agujas
Micro-Port'aghi



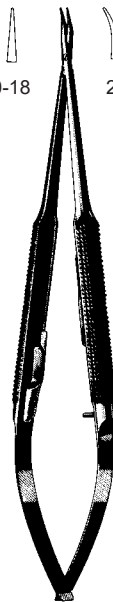
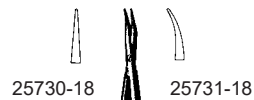
BARRAQUER
13 cm, 5¹/₈"



BARRAQUER
14 cm, 5¹/₂"



BARRAQUER
18 cm, 7"



BARRAQUER
18 cm, 7"

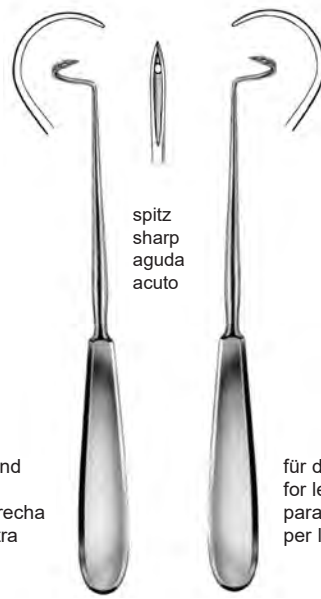
Unterbindungsnadeln
 Ligature Needles
 Aguja para ligaduras
 Aghi per legature



biegsam
 malleable
 maleable
 malleabile

27109-20
 20 cm, 8"

für die rechte Hand
 for right hand
 para la mano derecha
 per la mano destra

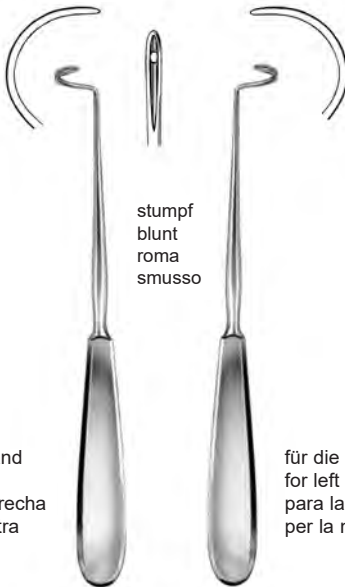


spitz
 sharp
 aguda
 acuto

DESCHAMPS

27110-21	21 cm, 8 ¹ / ₄ "	27111-21
27110-24	24 cm, 9 ¹ / ₂ "	27111-24
27110-27	27 cm, 10 ¹ / ₂ "	27111-27

für die linke Hand
 for left hand
 para la mano izquierda
 per la mano sinistra



stumpf
 blunt
 roma
 smusso

für die rechte Hand
 for right hand
 para la mano derecha
 per la mano destra

für die linke Hand
 for left hand
 para la mano izquierda
 per la mano sinistra

DESCHAMPS

27120-21	21 cm, 8 ¹ / ₄ "	27121-21
27120-24	24 cm, 9 ¹ / ₂ "	27121-24
27120-27	27 cm, 10 ¹ / ₂ "	27121-27

Unterbindungsnadeln
Ligature Needles
Agujas para ligaduras
Aghi per legature

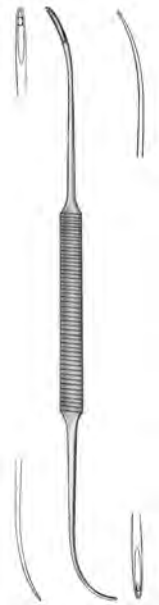
27130-13
fein, für die rechte Hand
delicate, for right hand
fina, para la mano derecha
fino, per la mano destra

stumpf
blunt
roma
smusso

27131-13
fein, für die linke Hand
delicate, for left hand
fina, para la mano izquierda
fino, per la mano sinistra



KRONECKER
13 cm, 5 1/8"

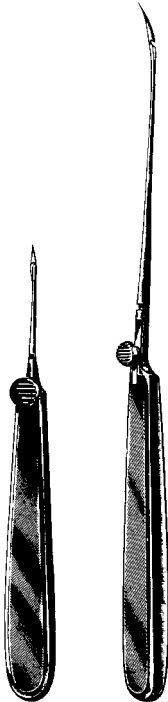


SCHMIEDEN-DICK
27134-32 32 cm, 12 3/4"
biegsam - malleable - maleable - malleabile



COOPER
27139-19 19 cm, 7 1/2"

Nahtinstrumente
Suturing Instruments
Instrumentos para suturas
Strumenti per suture



REVERDIN
27201-15 - 27204-21



Fig. 1

27201-15 15 cm, 6"
27201-19 19 cm, 7"
27201-21 21 cm, 8 1/4"



Fig. 2

27202-15 15 cm, 6"
27202-19 19 cm, 7 1/2"
27202-21 21 cm, 8 1/4"



Fig. 3

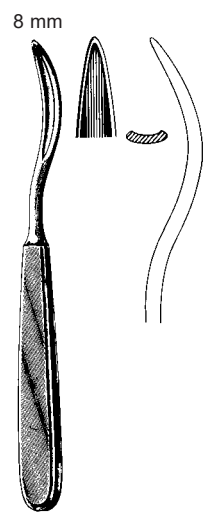
27203-15 15 cm, 6"
27203-19 19 cm, 7 1/2"
27203-21 21 cm, 8 1/4"



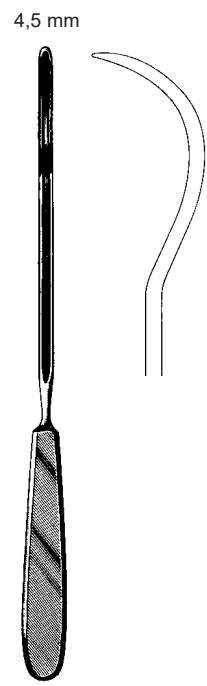
Fig. 4

27204-15 15 cm, 6"
27204-19 19 cm, 7 1/2"
27204-21 21 cm, 8 1/4"

Führungshohlsonden
Ligature Conductors
Sondas conductoras
Sonde conduttrici



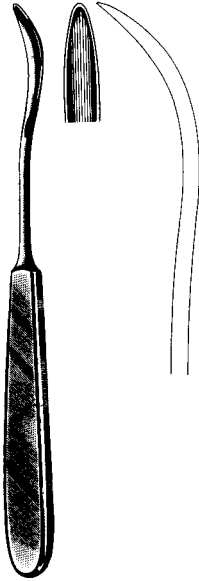
SCHMIEDEN
27271-19 19 cm, 7½"



KIRSCHNER
27277-25 25,5 cm, 10"

Führungshohlsonden, Fadenfänger, Fadengabel
 Ligature Conductors, Ligature Catcher, Ligature Adjuster
 Sondas conductoras, Captador de hilos, Horquilla de hilos
 Sonde conduttrici, Portalegature, Forchetta da sutura

5 mm



KOENIG
27285-20
20 cm, 8"

5 mm



PAYR
27288-22
22 cm, 8 3/4"

5 mm



PAYR
27289-22
22 cm, 8 3/4"

Plastik
plastic
plástico



BRUNNER
27291-18 18 cm, 7"
27291-27 27 cm, 10 1/2"



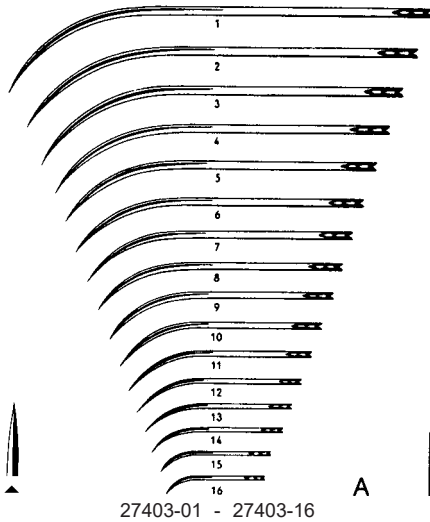
VIENNA
27297-23
23,5 cm, 9 1/4"



REDA
27298-23
23 cm, 9"

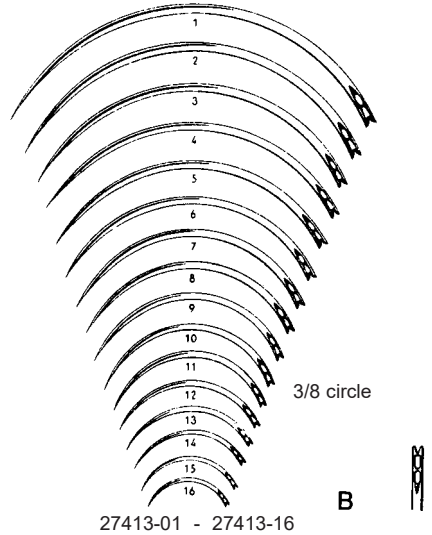
Chirurgische Nadeln
Suturing Needles
Agujas para suturas
Aghi per suture

Pack à 1 Dutzend
in packages of 1 dozen
en sobres de 1 docena
confezione 1 dozzina



27403-01 - 27403-16

A



27413-01 - 27413-16

3/8 circle

B

Fig.1 2 3 4 5 6 7 8 9 10 11 12 13 14 15 16

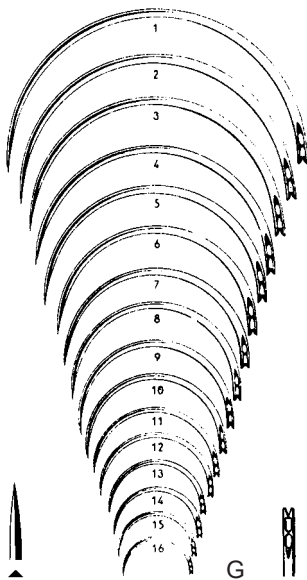
A 27403-01 27403-02 27403-03 27403-04 27403-05 27403-06 27403-07 27403-08 27403-09 27403-10 27403-11 27403-12 27403-13 27403-14 27403-15 27403-16

B 27413-01 27413-02 27413-03 27413-04 27413-05 27413-06 27413-07 27413-08 27413-09 27413-10 27413-11 27413-12 27413-13 27413-14 27413-15 27413-16

G 27423-01 27423-02 27423-03 27423-04 27423-05 27423-06 27423-07 27423-08 27423-09 27423-10 27423-11 27423-12 27423-13 27423-14 27423-15 27423-16

Ga 27433-01 27433-02 27433-03 27433-04 27433-05 27433-06 27433-07 27433-08 27433-09

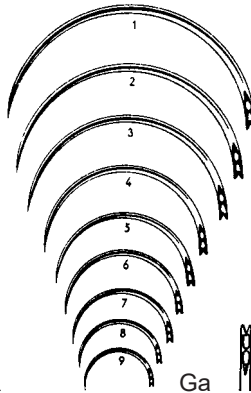
Gr 27434-01 27434-02 27434-03 27434-04 27434-05 27434-06 27434-07 27434-08 27434-09 27434-10 27434-11 27434-12 27434-13 27434-14 27434-15 27434-16



27423-01 - 27423-16

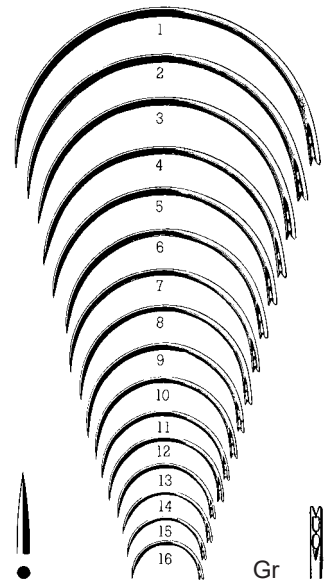
G

Alle Nadeln mit Ohr
all the needles with spring eye
todas las agujas con ojo a resorte
tutti gli aghi con cruna aperta



27433-01 - 27433-09

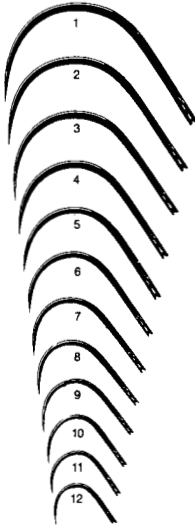
Ga



27434-01 - 27434-16

Gr

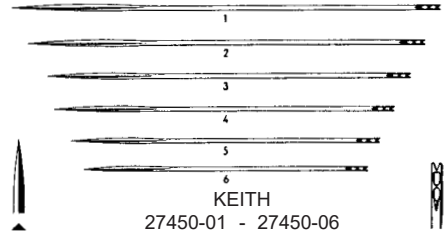
Alle Nadeln mit Öhr
 all the needles with spring eye
 todas las agujas con ojo a resorte
 tutti gli aghi con cruna aperta



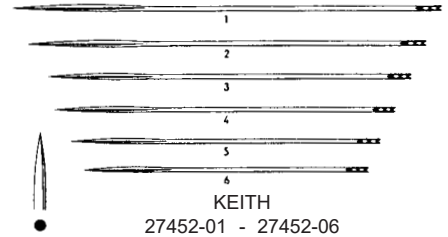
27441-01 - 27441-12



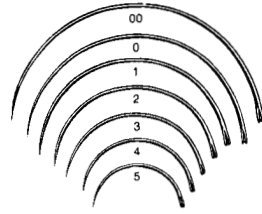
Chirurgische Nadeln
 Suturing Needles
 Agujas para suturas
 Aghi per suture



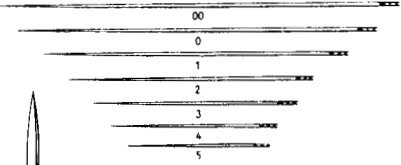
KEITH
 27450-01 - 27450-06



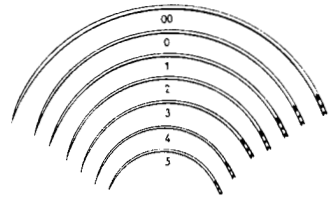
KEITH
 27452-01 - 27452-06



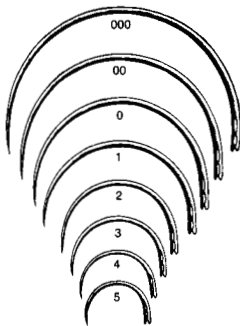
27465-20 - 27467-05 Pb



27475-20 - 27477-05 Pc



27485-20 - 27487-05 Pd



27443-30 - 27443-05

FIG.	000	00	0	1	2	3	4	5	6	7	8	9	10	11	12
KÖNIG				27441-01	27441-02	27441-03	27441-04	27441-05	27441-06	27441-07	27441-08	27441-09	27441-10	27441-11	27441-12
E	27443-30	27443-20	27443-10	27443-01	27443-02	27443-03	27443-04	27443-05							
KEITH				27450-01	27450-02	27450-03	27450-04	27450-05	27450-06						
KEITH				27452-01	27452-02	27452-03	27452-04	27452-05	27452-06						
Pb	27465-20	27465-10	27467-01	27467-02	27467-03	27467-04	27467-05								
Pc	27475-20	27475-10	27477-01	27477-02	27477-03	27477-04	27477-05								
Pd	27485-20	27485-10	27487-01	27487-02	27487-03	27487-04	27487-05								

Wundklammerpinzetten und -zängchen, Wundklammern
 Clip Applying Forceps, Suture Clips
 Pinzas aplicadoras para agrafes, Agrafes de sutura
 Pinze per applicare le agrafe, Agrafe



MICHEL
 27610-12
 12 cm, 4 3/4"



WACHENFELDT
 27612-12
 12,5 cm, 5"



WACHENFELDT
 27614-12
 12,5 cm, 5"



CHILDE
 27620-18
 18 cm, 7"



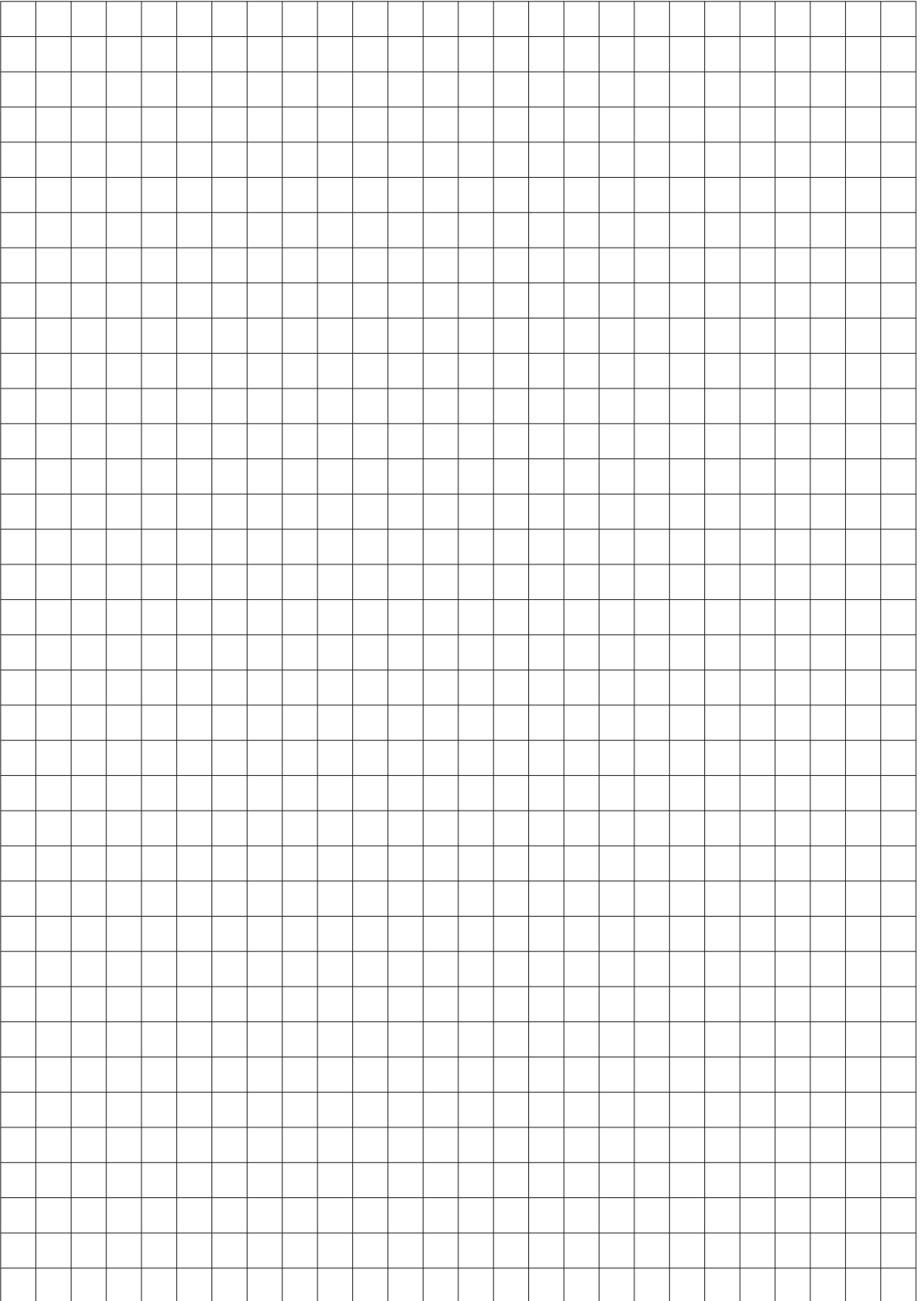
MICHEL
 27630-12
 12 cm, 4 3/4"

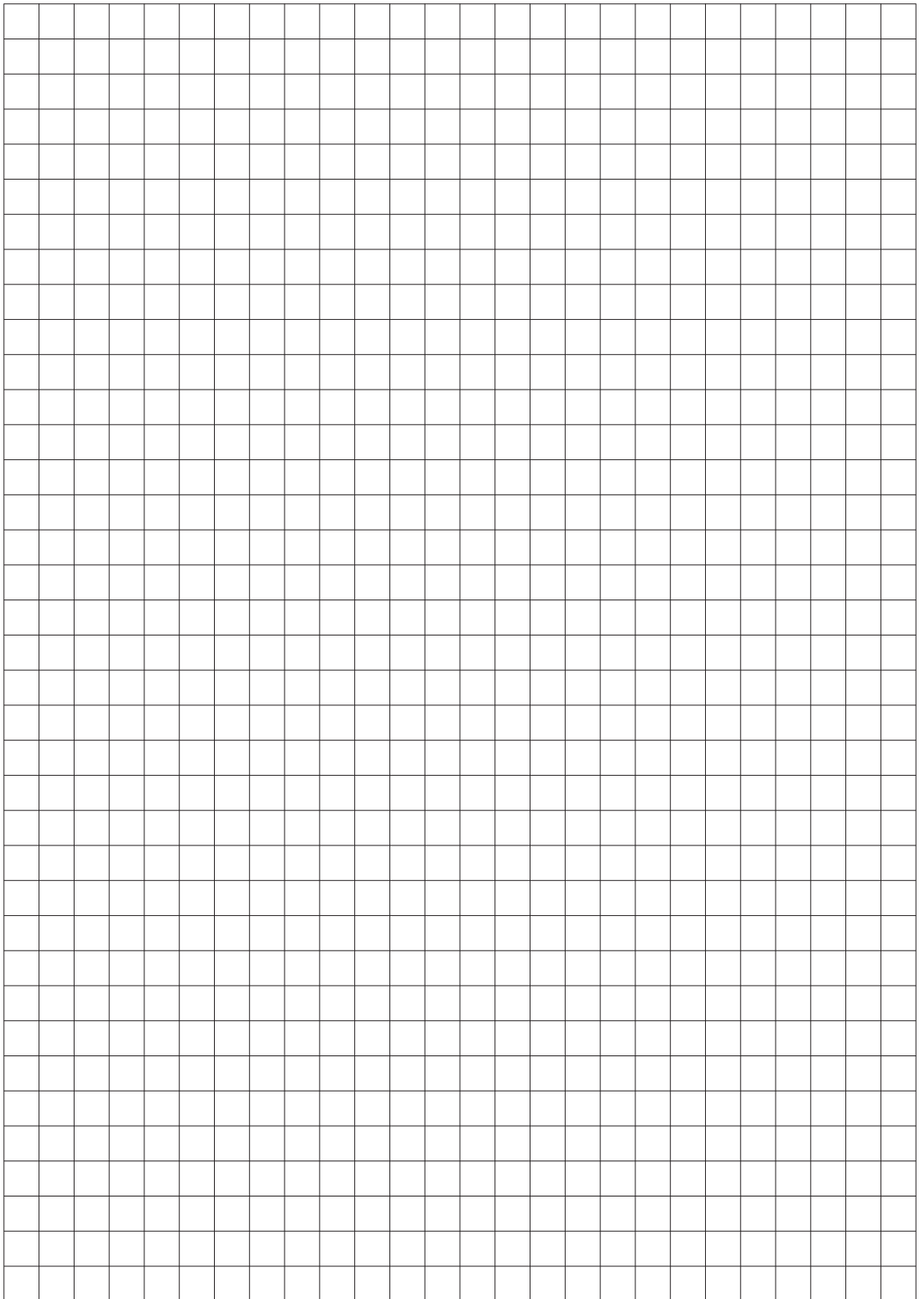


COLLIN
 27640-13
 13 cm, 5 1/8"



RICHTER-HEATH
 27642-14
 14 cm, 5 1/2"





Sterilisierzangen, Abfallzange, Sterilisierklammern, Messgerät
 Sterilization Instruments, Waste Forceps, Safety pins, Caliper
 Instrumentos esterilización, Pinza p. desechos, Cadres de estérilización, Calibrador
 Pinze per la sterilizzazione, Pinza per rifiuti, Spilloni p. sterilizzazione, Compasso



DAVIS
 29102-16 16 cm, 6¼"
 29102-20 20 cm, 8"
 29102-24 24 cm, 9½"



CHEATLE
 29110-27
 27 cm, 10¾"



UNIVERSAL
 29120-20 20 cm, 8" 29121-20
 29120-28 28 cm, 11" 29121-28



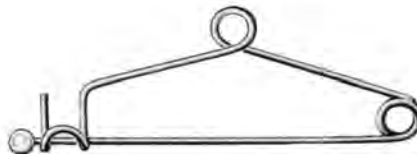
ROGGE
 29130-23
 23 cm, 9"



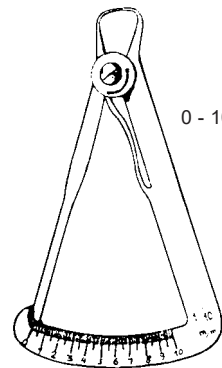
SAUERBRUCH
 29145-55
 55 cm, 21.7"



BUNT
 29150-12 12 cm, 4¾"



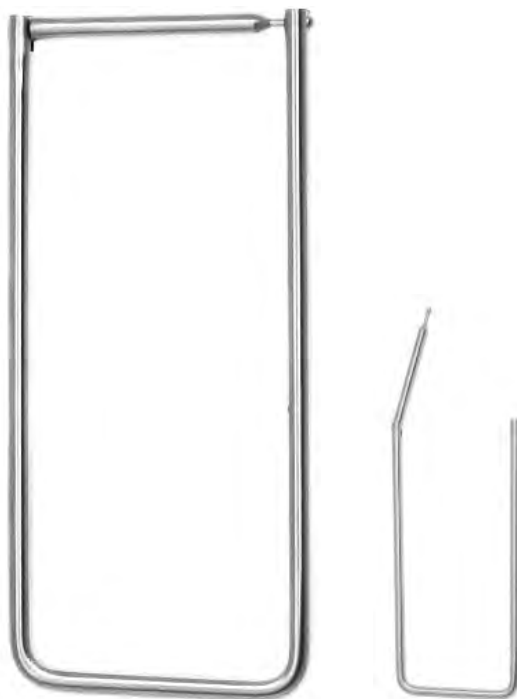
MAYO
 29152-14 14 cm, 5¾"



IWANSON
 89270-15

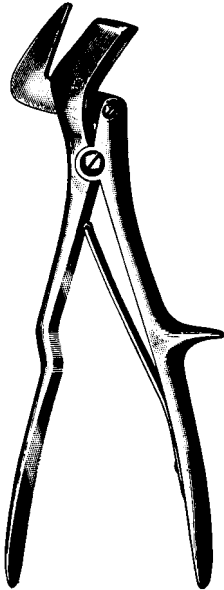
0 - 10 mm

Stringer
Stringer
listón
stringer



29160-10	4" x 2 1/2"
29160-15	6" x 2 1/2"
29160-20	8" x 2 1/2"
29160-25	10" x 2 1/2"
29160-30	12" x 2 1/2"

Gipsscheren
Plaster of Paris Shears
Cizallas para vendajes enyesados
Cesoie per gessi



STILLE
31101-24 24 cm, 9 1/2"

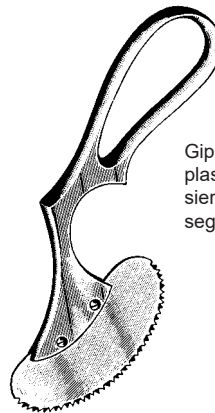


STILLE
31103-23 23 cm, 9"
31103-26 26 cm, 10 1/4"
31103-37 37 cm, 14 1/2"



Gipsmesser
plaster knife
cuchillo para vendajes enyesados
coltello da gesso

WIGMORE
31120-19 19 cm, 7 1/2"



Gipssäge
plaster saw
sierra para vendajes enyesados
sega da gesso

ENGEL
31130-14 16 cm, 6 1/4"
verchromt, chrome plated

Autopsiesäge
Autopsy saw
Sierra para autopsia
Sega per autopsia

Geräuschpegel: 52 - 77 db (A)
Noise level: 52 - 77 db (A)
Nivel de ruido del aparato sólo: 52 - 77 db (A)
Livello acustico dello strumento solo: 52 - 77 db (A)

6500-24000 Schwingungen pro Minute
6500-24000 oscillations per minute
6500-24000 oscilaciones por minuto
6500-24000 oscillazioni al minute

EN 60601-1, EN 60601-1-2, IEC 60601-1, IEC 60601-1-2



31201-01 120 Volt, 500 Watt, 1,5 kg

31201-02 230 Volt, 500 Watt, 1,5 kg

31201-01 + 31201-02 inklusive, inclusive, inclusive, inclusive:

1x 31210-50 Ø 50mm Sägeblatt, saw blade, hoja de repuesto, lama per sega

1x 31210-65 Ø 65mm Sägeblatt, saw blade, hoja de repuesto, lama per sega

1x 31204-01 Ø 50/65mm Segment-Sägeblatt, segment saw blade, hoja de repuesto para segmento, lama per sega a segmento

1x 31202-16 Inbusschlüssel T-Griff, alan key with T-handle, llave hexagonal con mango de T, chiave esagonale con manico a T

1x 31200-95 Spritze, gefüllt mit Fett, injection filled with fat, jeringa rellena con grasa, siringa colmata con grassa

1x 31212-02 Paar Gabelschlüssel, pair flat wrench, pareja llave de boca, paio chiave a bocca, 11 mm

Zubehör für Autopsiesäge 31201-02 und 31201-01 siehe Seite 230/14 - 230/18
 Accessories for Autopsy saw 31201-02 and 31201-01 please see page 230/14 - 230/18
 Accesorios para sierra para autopsia 31201-02 y 31201-01 vea la página 230/14 - 230/18
 Accessorio per sega per autopsia 31201-02 e 31201-01 vedi pagina 230/14 - 230/18

31210-45	Ø 45mm	Sägeblatt, saw blade, hoja de repuesto, lama per sega
31210-50	Ø 50mm	Sägeblatt, saw blade, hoja de repuesto, lama per sega
31210-65	Ø 65mm	Sägeblatt, saw blade, hoja de repuesto, lama per sega
31204-01	Ø 50/65mm	Segment-Sägeblatt, segment saw blade, hoja de repuesto para segmento, lama per sega a segmento
31204-03	Ø 65/65mm	Segment-Sägeblatt, segment saw blade, hoja de repuesto para segmento, lama per sega a segmento
31205-08	8mm	Tiefen-Sägeblatt, deep cutting saw, hoja de sierra de profundidad, lama a taglio di profondità
31205-20	20mm	Tiefen-Sägeblatt, deep cutting saw, hoja de sierra de profundidad, lama a taglio di profondità
31203-50		Begrenzungsscheibe, limiting disc, disco de tope, disco eccentrico
31202-16		Inbusschlüssel T-Griff, alan key with T-handle, llave hexagonal con mango de T, chiave esagonale con manico a T
31200-95		Spritze gefüllt mit Fett, injection filled with fat, jeringa rellena con grasa, siringa colmata con grassa
31212-02		1 Paar Gabelschlüssel, pair flat wrench, pareja llave de boca, paio chiave a bocca, 11mm

Autopsiesäge
Autopsy saw
Sierra para autopsia
Sega per autopsia

Geräuschpegel: 52 - 77 db (A)
Noise level: 52 - 77 db (A)
Nivel de ruido del aparato sólo: 52 - 77 db (A)
Livello acustico dello strumento solo: 52 - 77 db (A)

6500-24000 Schwingungen pro Minute
6500-24000 oscillations per minute
6500-24000 oscilaciones por minuto
6500-24000 oscillazioni al minute

EN 60601-1, EN 60601-1-2, IEC 60601-1, IEC 60601-1-2



Dreikantschaft
Three-jaw chuck
Mandril de tres mordazas
Mandrino con tre ganasce



31201-11 120 Volt, 500 Watt, 1,5 kg

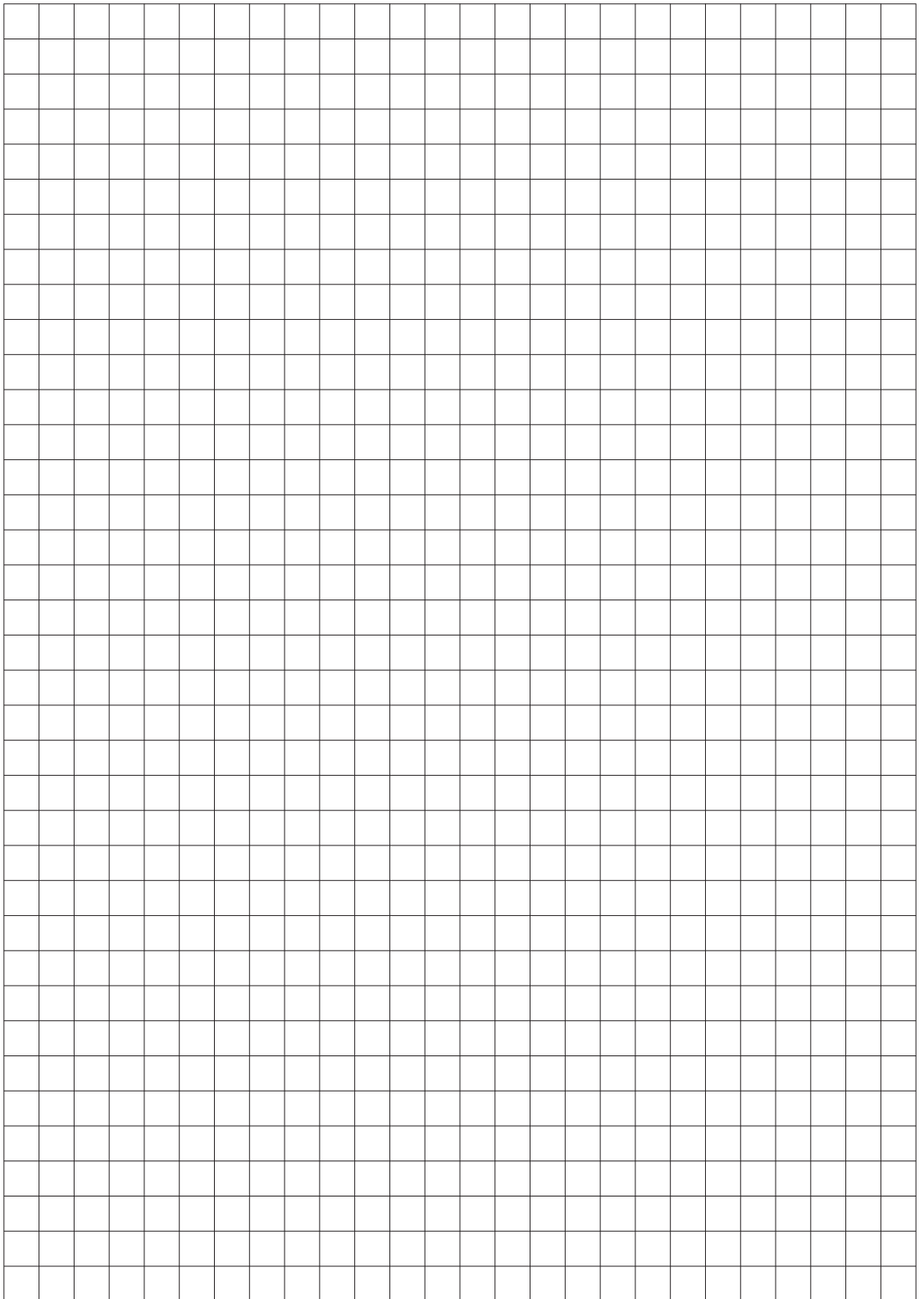
31201-22 230 Volt, 500 Watt, 1,5 kg

31201-11 + 31201-22 inklusive, inclusive, inclusive, inclusive:

- 31201-39 39mm Schaft komplett, Arbor complete, Vastago completo, Asta completa
- 1x 31210-50 Ø 50mm Sägeblatt, saw blade, hoja de repuesto, lama per sega
- 1x 31210-65 Ø 65mm Sägeblatt, saw blade, hoja de repuesto, lama per sega
- 1x 31204-01 Ø 50/65mm Segment-Sägeblatt, segment saw blade, hoja de repuesto para segmento, lama per sega a segmento
- 1x 31202-16 Inbusschlüssel T-Griff, alan key with T-handle, llave hexagonal con mango de T, chiave esagonale con manico a T
- 1x 31200-95 Spritze gefüllt mit Fett, injection filled with fat, jeringa rellena con grasa, siringa colmata con grassa
- 1x 31202-14 Paar Gabelschlüssel, pair flat wrench, pareja llave de boca, paio chiave a bocca, 14 mm

Zubehör für Autopsiesäge 31201-22 und 31201-11 siehe Seite 230/14 - 230/18
Accessories for Autopsy saw 31201-22 and 31201-11 please see page 230/14 - 230/18
Accesorios para sierra para autopsia 31201-22 y 31201-11 vea la página 230/14 - 230/18
Accessorio per sega per autopsia 31201-22 e 31201-11 vedi pagina 230/14 - 230/18

31210-45	Ø 45mm	Sägeblatt, saw blade, hoja de repuesto, lama per sega
31210-50	Ø 50mm	Sägeblatt, saw blade, hoja de repuesto, lama per sega
31210-65	Ø 65mm	Sägeblatt, saw blade, hoja de repuesto, lama per sega
31204-01	Ø 50/65mm	Segment-Sägeblatt, segment saw blade, hoja de repuesto para segmento, lama per sega a segmento
31204-03	Ø 65/65mm	Segment-Sägeblatt, segment saw blade, hoja de repuesto para segmento, lama per sega a segmento
31202-16		Inbusschlüssel T-Griff, alan key with T-handle, llave hexagonal con mango de T, chiave esagonale con manico a T
31200-95		Spritze gefüllt mit Fett, injection filled with fat, jeringa rellena con grasa, siringa colmata con grassa



Zubehör zur Autopsiesäge
Accessories for Autopsy saw
Accesorio para la sierra de autopsia
Accessori per sega per autopsia

Set 31203-10**Set 31203-10:** 31201-39 + 31210-65**Set 31203-00:** 31201-39 + 31210-50**Set 31203-20:** 31201-58 + 31210-50**Set 31203-30:** 31201-58 + 31210-65**Set 31204-00****Set 31204-00:** 31201-39 + 31204-01**Set 31204-10:** 31201-39 + 31204-03**Set 31204-20:** 31201-58 + 31204-01**Set 31204-30:** 31201-58 + 31204-03

Zubehör zur Autopsiesäge
 Accessories for Autopsy saw
 Accesorio para la sierra de autopsia
 Accessori per sega per autopsia

Set 31205-00



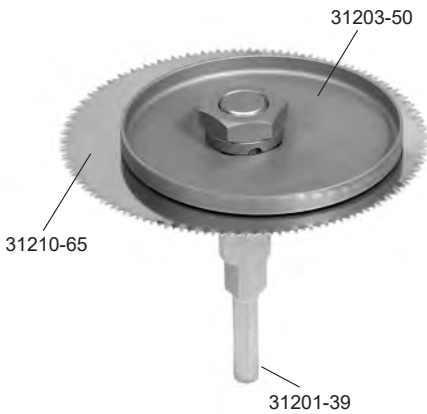
Set 31205-00: 31201-39 + 31205-20

Set 31206-00: 31201-39 + 31205-08

Set 31206-10: 31201-58 + 31205-08

Set 31205-10: 31201-58 + 31205-20

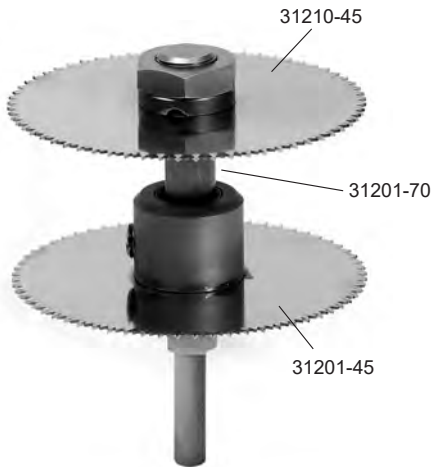
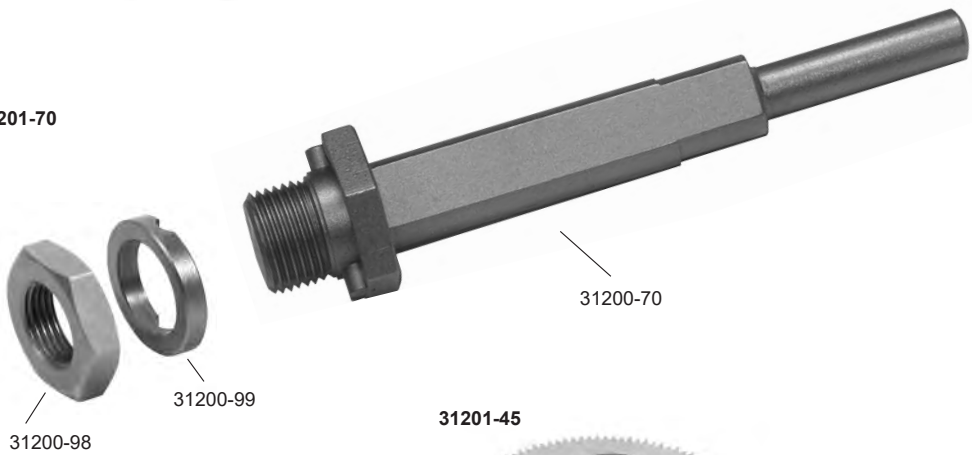
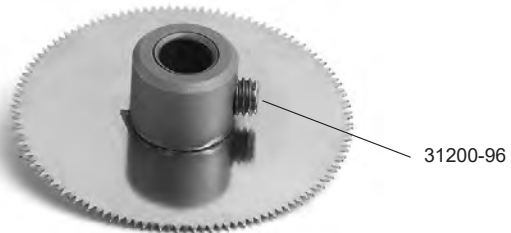
Set 31210-10



Set 31210-10: 31201-39 + 31210-65 + 31203-50

Set 31210-00: 31201-58 + 31210-65 + 31203-50

Zubehör zur Autopsiesäge
Accessories for Autopsy saw
Accesorio para la sierra de autopsia
Accessori per sega per autopsia

Set 31202-00**Set 31202-00:** 31201-70 + 31210-45 + 31201-45**31201-70****31201-45**

Zubehör für Autopsiesäge 31201-22 und 31201-11 siehe Seite 230/4 - 230/7
 Accessories for Autopsy saw 31201-22 and 31201-11 please see page 230/4 - 230/7
 Accesorios para sierra para autopsia 31201-22 y 31201-11 vea la página 230/4 - 230/7
 Accessorio per sega per autopsia 31201-22 e 31201-11 vedi pagina 230/4 - 230/7

31200-39	Schaft 39mm allein
31201-39	Schaft 39mm komplett
31203-00	Schaft 39mm komplett + Sägeblatt Ø 50mm
31203-10	Schaft 39mm komplett + Sägeblatt Ø 65mm
31204-00	Schaft 39mm komplett + Segmentsägeblatt 50/65mm
31204-10	Schaft 39mm komplett + Segmentsägeblatt 65/65mm
31210-10	Schaft 39mm komplett + Sägeblatt Ø 65mm + Begrenzungsscheibe
31206-00	Schaft 39mm komplett + Tiefensägeblatt 8mm
31205-00	Schaft 39mm komplett + Tiefensägeblatt 20mm
31200-58	Schaft 58mm allein
31201-58	Schaft 58mm komplett
31203-20	Schaft 58mm komplett + Sägeblatt Ø 50mm
31203-30	Schaft 58mm komplett + Sägeblatt Ø 65mm
31204-20	Schaft 58mm komplett + Segmentsägeblatt 50/65mm
31204-30	Schaft 58mm komplett + Segmentsägeblatt 65/65mm
31210-00	Schaft 58mm komplett + Sägeblatt Ø 65mm + Begrenzungsscheibe
31206-10	Schaft 58mm komplett + Tiefensägeblatt 8mm
31205-10	Schaft 58mm komplett + Tiefensägeblatt 20mm
31200-70	Schaft Doppelsäge allein
31201-70	Schaft Doppelsäge komplett
31202-00	Schaft Doppelsäge komplett + Sägeblatt Ø 45mm + verstellbares Sägeblatt Ø 45mm
31201-45	verstellbares Sägeblatt Ø 45mm komplett
31200-96	Inbusmadenschraube für verstellbares Sägeblatt Ø 45mm komplett
31200-98	Mutter für Schaft
31200-99	Sperring für Schaft
31200-39	Arbor 39mm only
31201-39	Arbor 39mm complete
31203-00	Arbor 39mm complete + saw blade Ø 50mm
31203-10	Arbor 39mm complete + saw blade Ø 65mm
31204-00	Arbor 39mm complete + segment saw blade 50/65mm
31204-10	Arbor 39mm complete + segment saw blade 65/65mm
31210-10	Arbor 39mm complete + saw blade Ø 65mm + limiting disc
31206-00	Arbor 39mm complete + deep cutting saw 8mm
31205-00	Arbor 39mm complete + deep cutting saw 20mm
31200-58	Arbor 58mm only
31201-58	Arbor 58mm complete
31203-20	Arbor 58mm complete + saw blade Ø 50mm
31203-30	Arbor 58mm complete + saw blade Ø 65mm
31204-20	Arbor 58mm complete + segment saw blade 50/65mm
31204-30	Arbor 58mm complete + segment saw blade 65/65mm
31210-00	Arbor 58mm complete + saw blade Ø 65mm + limiting disc
31206-10	Arbor 58mm complete + deep cutting saw 8mm
31205-10	Arbor 58mm complete + deep cutting saw 20mm
31200-70	Double saw only
31201-70	Double saw complete
31202-00	Double saw complete + saw blade Ø 45mm + adjustable saw blade Ø 45mm
31201-45	Adjustable saw blade Ø 45mm complete
31200-96	Allen screw for adjustable saw blade Ø 45mm complete
31200-98	Nut for arbor
31200-99	Blocking ring for arbor

Zubehör für Autopsiesäge 31201-22 und 31201-11 siehe Seite 230/4 - 230/7
 Accessories for Autopsy saw 31201-22 and 31201-11 please see page 230/4 - 230/7
 Accesorios para sierra para autopsia 31201-22 y 31201-11 vea la página 230/4 - 230/7
 Accessorio per sega per autopsia 31201-22 e 31201-11 vedi pagina 230/4 - 230/7

31200-39	Vastago 39mm suelto
31201-39	Vastago 39mm completo
31203-00	Vastago 39mm completo + hoja de repuesto Ø 50mm
31203-10	Vastago 39mm completo + hoja de repuesto Ø 65mm
31204-00	Vastago 39mm completo + hoja de repuesto para segmento 50/65mm
31204-10	Vastago 39mm completo + hoja de repuesto para segmento 65/65mm
31210-10	Vastago 39mm completo + hoja de repuesto Ø 65mm + disco de tope
31206-00	Vastago 39mm completo + hoja de sierra de profundidad 8mm
31205-00	Vastago 39mm completo + hoja de sierra de profundidad 20mm
31200-58	Vastago 58mm suelto
31201-58	Vastago 58mm completo
31203-20	Vastago 58mm completo + hoja de repuesto Ø 50mm
31203-30	Vastago 58mm completo + hoja de repuesto Ø 65mm
31204-20	Vastago 58mm completo + hoja de repuesto para segmento 50/65mm
31204-30	Vastago 58mm completo + hoja de repuesto para segmento 65/65mm
31210-00	Vastago 58mm completo + hoja de repuesto Ø 65mm + disco de tope
31206-10	Vastago 58mm completo + hoja de sierra de profundidad 8mm
31205-10	Vastago 58mm completo + hoja de sierra de profundidad 20mm
31200-70	Doble sierra suelta
31201-70	Doble sierra completa
31202-00	Doble sierra completa + hoja de repuesto Ø 45mm + hoja de sierra ajustable Ø 45mm
31201-45	hoja de sierra ajustable Ø 45mm completa
31200-96	tornillo con hembra hexagonal para hoja de sierra ajustable Ø 45mm completa
31200-98	tuerca para vastago
31200-99	anillo de recambio para vastago
31200-39	Asta 39mm sola
31201-39	Asta 39mm completa
31203-00	Asta 39mm completa + lama per sega Ø 50mm
31203-10	Asta 39mm completa + lama per sega Ø 65mm
31204-00	Asta 39mm completa + lama per sega a segmento 50/65mm
31204-10	Asta 39mm completa + lama per sega a segmento 65/65mm
31210-10	Asta 39mm completa + lama per sega Ø 65mm + disco eccentrico
31206-00	Asta 39mm completa + lama a taglio di profondità 8mm
31205-00	Asta 39mm completa + lama a taglio di profondità 20mm
31200-58	Asta 58mm sola
31201-58	Asta 58mm completa
31203-20	Asta 58mm completa + lama per sega Ø 50mm
31203-30	Asta 58mm completa + lama per sega Ø 65mm
31204-20	Asta 58mm completa + lama per sega a segmento 50/65mm
31204-30	Asta 58mm completa + lama per sega a segmento 65/65mm
31210-00	Asta 58mm completa + lama per sega Ø 65mm + disco eccentrico
31206-10	Asta 58mm completa + lama a taglio di profondità 8mm
31205-10	Asta 58mm completa + lama a taglio di profondità 20mm
31200-70	Sega a doppia lama sola
31201-70	Sega a doppia lama completa
31202-00	Sega a doppia lama completa + lama per sega Ø 45mm + lame per sega regolabile Ø 45mm
31201-45	lame per sega regolabile Ø 45mm completa
31200-96	tornillo con hembra hexagonal para hoja de sierra ajustable Ø 45mm completa
31200-98	brugola per asta
31200-99	anello di ricambio per asta

Oszillierende Gipssäge
 Oscillating Plaster Saw
 Sierra oscilante p. vendajes enyesados
 Sega oscillante per gessi

Geräuschpegel: 52 - 77 db (A)

Noise level: 52 - 77 db (A)

Nivel de ruido del aparato sólo: 52 - 77 db (A)

Livello acustico dello strumento solo: 52 - 77 db (A)

6500-24000 Schwingungen pro Minute

6500-24000 oscillations per minute

6500-24000 oscilaciones por minuto

6500-24000 oscillazioni al minute

EN 60601-1, EN 60601-1-2, IEC 60601-1, IEC 60601-1-2



31210-21 120 Volt, 500 Watt, 1,5 kg

31210-22 230 Volt, 500 Watt, 1,5 kg

31210-21 + 31210-22 inklusive, inclusive, inclusive, inclusive:

1x 31210-50 Ø 50mm Sägeblatt, saw blade, hoja de repuesto, lama per sega

1x 31210-65 Ø 65mm Sägeblatt, saw blade, hoja de repuesto, lama per sega

1x 31212-02 Paar Gabelschlüssel, pair flat wrench, pareja llave de boca, paio chiave a bocca, 11mm

Zubehör für oszillierende Gipssäge 31210-22 und 31210-21 siehe Seite 230/14 - 230/18
 Accessories for oscillating plaster saw 31210-22 and 31210-21 please see page 230/14 - 230/18
 Accesorios p. sierra oscilante p. vendajes enyesados 31210-22 y 31210-21 vea la página 230/14 - 230/18
 Accessorio per sega oscillante per gessi 31210-22 e 31210-21 vedi pagina 230/14 - 230/18

31212-02 1 Paar Gabelschlüssel, pair flat wrench, pareja llave de boca, paio chiave a bocca, 11mm
 31210-30 Koffer, case, maleta, valigia

Naturgipsverbände / bandage / vendajes enyesados / bandaggio in gesso

31210-45 Ø 45mm Sägeblatt, saw blade, hoja de repuesto, lama per sega
 31210-50 Ø 50mm Sägeblatt, saw blade, hoja de repuesto, lama per sega

 31210-65 Ø 65mm Sägeblatt, saw blade, hoja de repuesto, lama per sega
 31204-01 Ø 50/65mm Segment-Sägeblatt, segment saw blade, hoja de repuesto para segmento, lama per sega a segmento
 31204-03 Ø 65/65mm Segment-Sägeblatt, segment saw blade, hoja de repuesto para segmento, lama per sega a segment
 31205-08 8mm Tiefen-Sägeblatt, deep cutting saw, hoja de sierra de profundidad, lama a taglio di profondità
 31205-20 20mm Tiefen-Sägeblatt, deep cutting saw, hoja de sierra de profundidad, lama a taglio di profondità

synthetische Hartverbände / synthetic bandage / vendajes sinteticos / bandaggio sintetico

31211-45 Ø 45mm Sägeblatt, saw blade, hoja de repuesto, lama per sega
 31211-50 Ø 50mm Sägeblatt, saw blade, hoja de repuesto, lama per sega
 31211-65 Ø 65mm Sägeblatt, saw blade, hoja de repuesto, lama per sega
 31204-02 Ø 50/65mm Segment-Sägeblatt, segment saw blade, hoja de repuesto para segmento, lama per sega a segmento
 31204-04 Ø 65/65mm Segment-Sägeblatt, segment saw blade, hoja de repuesto para segmento, lama per sega a segment
 31205-09 8mm Tiefen-Sägeblatt, deep cutting saw, hoja de sierra de profundidad, lama a taglio di profondità
 31205-21 20mm Tiefen-Sägeblatt, deep cutting saw, hoja de sierra de profundidad, lama a taglio di profondità

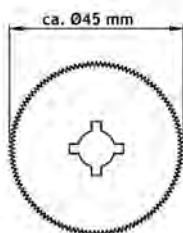
PTFE synthetische Hartverbände / PTFE synthetic bandage / PTFE vendajes sinteticos / PTFE bandaggio sintetico

31212-50 Ø 50mm Sägeblatt, saw blade, hoja de repuesto, lama per sega
 31212-65 Ø 65mm Sägeblatt, saw blade, hoja de repuesto, lama per sega

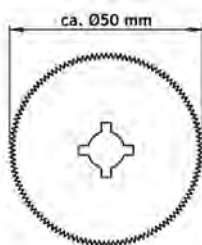
Naturgipsverbände und synthetische Hartverbände / Bandage and synthetic bandage / Vendajes enyesados y vendajes sinteticos / Bandaggio in gesso e bandaggio sintetico

31203-50 Begrenzungsscheibe, limiting disc, disco de tope, disco eccentrico

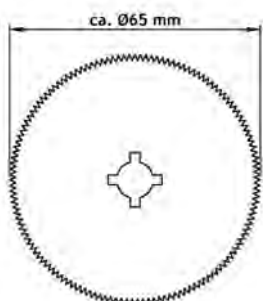
Sägeblätter
Saw blades
Hojas de repuesto
Lame per sega



31210-45
31211-45

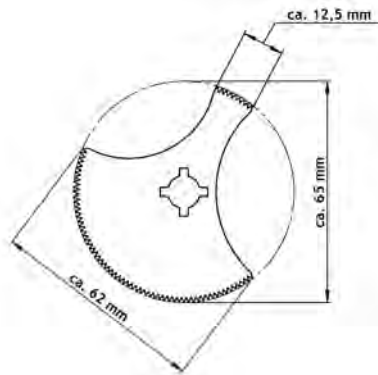


31210-50
31211-50
31212-50

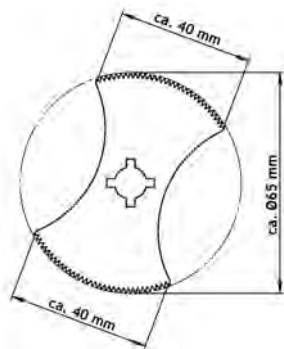


31210-65
31211-65
31212-65

Segment-Sägeblätter
Segment saw blades
Hojas de repuesto para segmento,
Lame per sega a segment

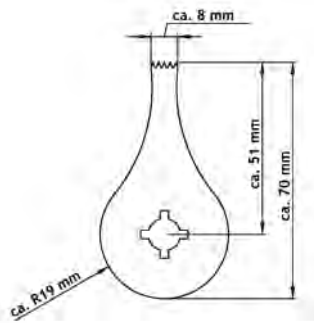


31204-01 Ø 50/65mm
31204-02 Ø 50/65mm



31204-03 Ø 65/65mm
31204-04 Ø 65/65mm

Tiefen-Sägeblätter
depp cutting saw
Hojas de sierra de profundidad,
Lame a taglio di profondità

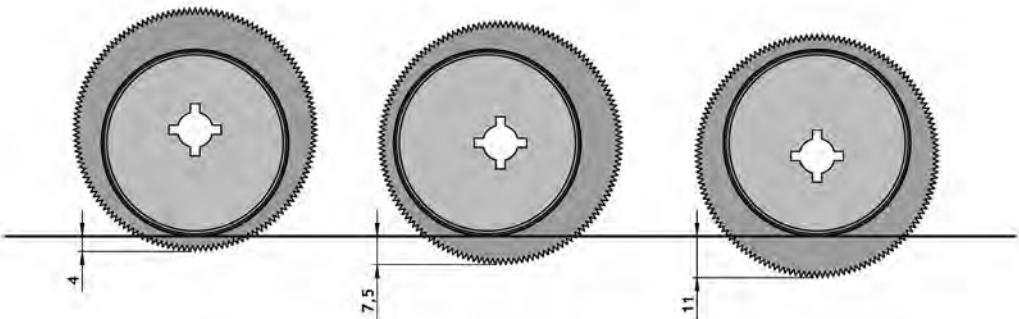


31205-08 8mm
31205-09 8mm

Sägeblätter
Saw blades
Hojas de repuesto
Lame per sega



31203-50
Begrenzungsscheibe
Limiting disc
Disco de tope
Disco eccentrico



31203-50
für Sägeblatt mit Ø 65mm
for Saw blade with Ø 65mm
para hoja de sierra Ø 65mm
per lama di sega Ø 65mm



- 31210-65
- 31204-01
- 31204-03
- 31211-65
- 31204-02
- 31204-04
- 31212-65

Zubehör
Accessories
Accesorio
Accessori



31200-95



31202-16



31210-30



31212-02, 11 mm
31202-14, 14 mm



31220-99
10 Stück
10 pieces
10 piezas
10 pezzi

Absauganlage und Wagen ohne Gipssäge
Hoover and carriage without plaster saw
Aspirador y careta sin sierra
Aspirazione e carello senza sega

31252-11 120 Volt, 500 - 800 Watt (800 PT), 19 kg

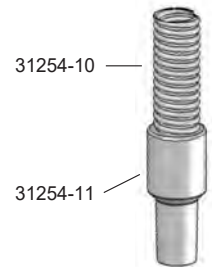
31252-22 230 Volt, 500 - 800 Watt (800 PT), 19 kg



31254-10

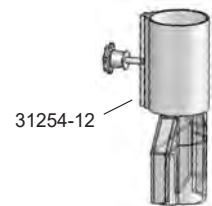


Aufgebaute Einheit
Set-up unit



31254-10

31254-11



31254-12

31253-00 230 Volt
31253-11 120 Volt

Zubehör für 31252-22 und 31252-11
 Accessories for 31252-22 and 31252-11
 Accesorios para 31252-22 y 31252-11
 Accessorio per 31252-22 e 31252-11

- 31253-00 230 Volt, Staubsauger, Hoover, aspirador, aspirapolvere
 31253-11 120 Volt, Staubsauger, Hoover, aspirador, aspirapolvere
 31254-10 Saugschlauch 3,3 Meter, schwarz, suction hose 3,3 meter, black, manguera de aspiracion 3,3 metros, negra, tubo di aspirazione 3,3 metri, nera
 31254-11 Saugdüse schwarz, suction nozzle black, boquilla aspirante negra, ugello aspirante nero
 31254-12 Saughaube kpl., suction cover cpl., cofia de aspiracion cpl., cuffia di aspirazione cpl.
 31250-10 Set Filtertüten, set filter paper, set de filtros, set di filtri:
 1x 31250-15
 6x 31250-12
 6x 31250-14

- 31250-12 Staubbeutel, Ather, antera, antera



- 31250-13 Motorfilter, motor filter, filtro para motor, filtro per motore

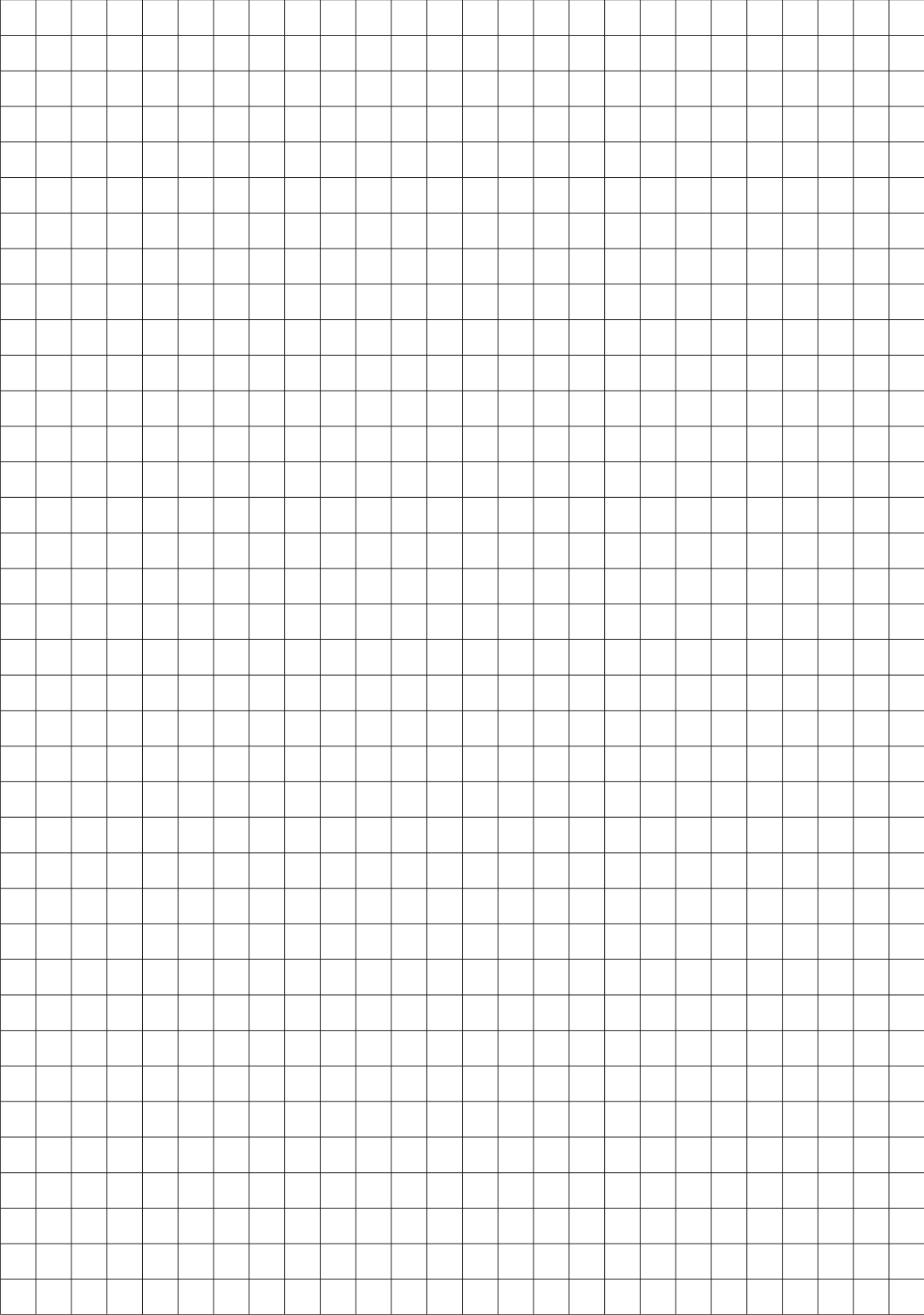


- 31250-14 Duftstick, flavor stick, stick de aroma, stick di effluvio

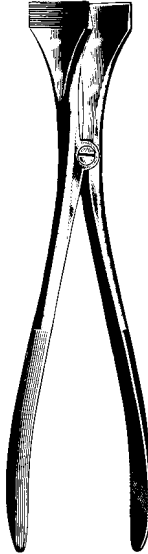


- 31250-15 HEPA-Filter, HEPA-Filter, filtro HEPA, filtro HEPA,

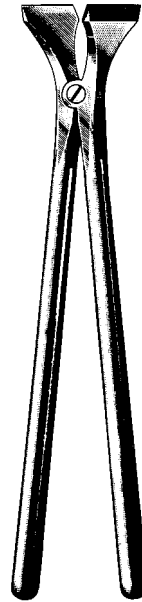




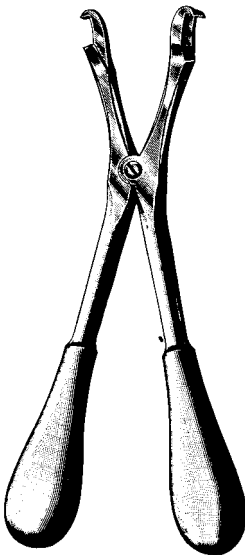
Gipsspreizer
 Plaster Cast Instruments
 Instrumentos para vendajes enyesados
 Allargagessi



HENNIG
 31350-28 28 cm, 11"



BEESON
 31360-30 30 cm, 11³/₄"



HAGLUND-STILLE
 31362-28 28 cm, 11"



REDA
 31366-23 23 cm, 9"

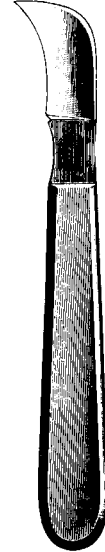
Gipsmesser, Gipsabreißzangen
Plaster Cast Instruments, Knives
Instrumentos para vendajes enyesados, Cuchillos
Allargagessi, Coltelli per Gessi, Strappagessi



HOPKINS
31370-20
20 cm, 8"



ESMARCH
31380-18
18 cm, 7"



REINER
31390-18
18 cm, 7"

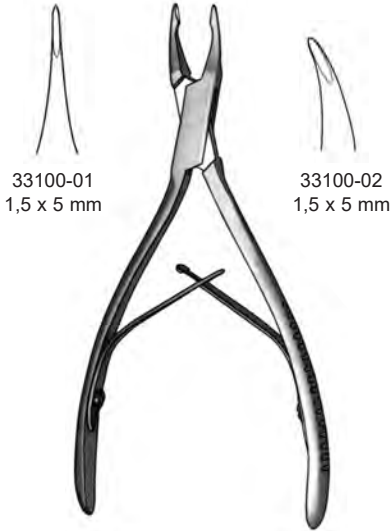


WOLFF
31395-18
18 cm, 7"



WOLFF
31397-24
24 cm, 9 1/2"

Hohlmeißelzangen
 Bone Rongeurs
 Pinzas-gubias
 Pinze sgorbie



33100-01
1,5 x 5 mm

33100-02
1,5 x 5 mm

MICRO FRIEDMAN
14 cm, 5 1/2"



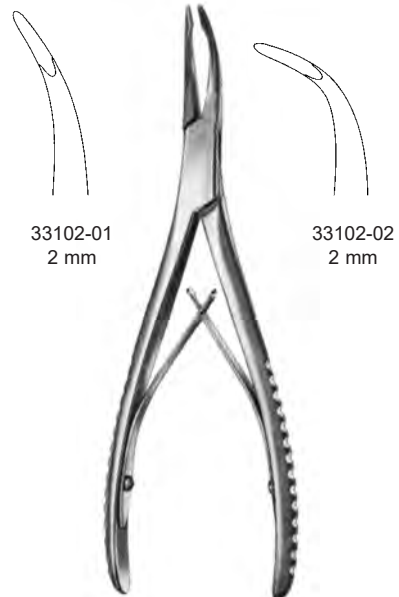
2 mm

FRIEDMAN Mini
33101-12 12 cm, 4 3/4"



3,5 mm

FRIEDMAN
33101-14 14 cm, 5 1/2"



33102-01
2 mm

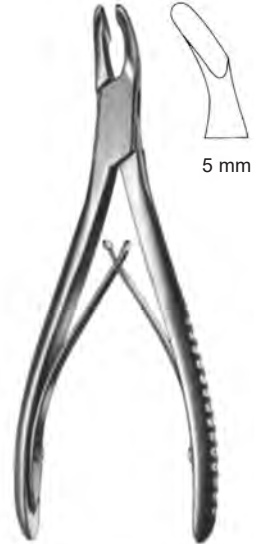
33102-02
2 mm

STELLBRINK
17 cm, 6 3/4"

Hohlmeißelzangen
Bone Rongeurs
Pinzas-gubias
Pinze sgorbie



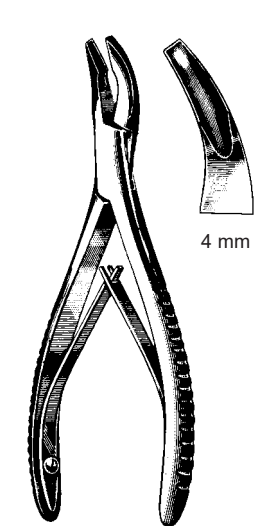
CLEVELAND
33103-14 14 cm, 5 1/2"



CLEVELAND
33105-17 17 cm, 6 3/4"

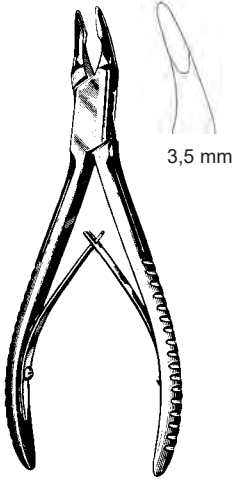


MEAD
33107-16 16,5 cm, 6 1/2"

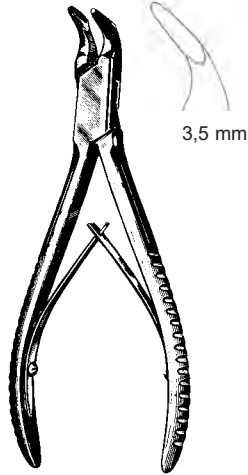


MEAD
33109-16 16,5 cm, 6 1/2"

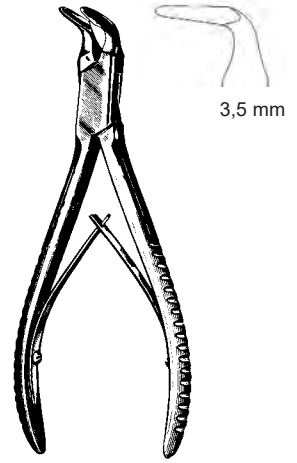
Hohlmeißelzangen
Bone Rongeurs
Pinzas-gubias
Pinze sgorbie



BLUMENTHAL
33115-15
15,5 cm, 6"



BLUMENTHAL
33117-15
15,5 cm, 6"



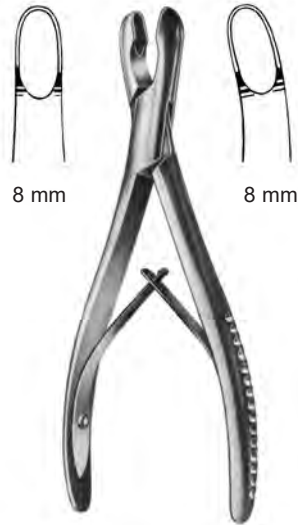
BLUMENTHAL
33119-15
15,5 cm, 6"



LUER
33131-15
15 cm, 5.9"



LUER
33133-15
15 cm, 5.9"



LUER
33136-17 33137-17
17 cm, 6 2/4"



ADSON
33142-20 33143-20
20 cm, 7.9"

Hohlmeißelzangen
Bone Rongeurs
Pinzas-gubias
Pinze sgorbie



OLIVECRONA
33147-20
20 cm, 7.9"



BANE-HARTMANN
33148-18
17,5 cm, 7"



LEMPERT
33150-16 33151-16
16 cm, 6 1/4"



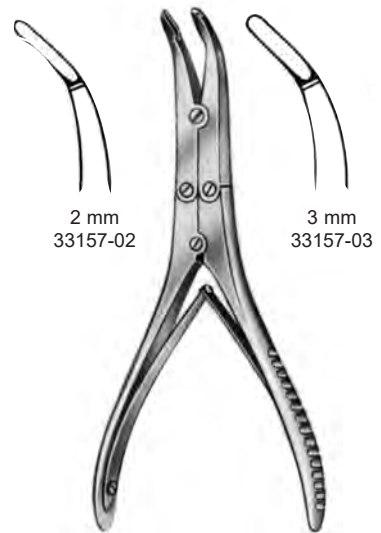
JANSEN
17 cm, 6 3/4"



LEMPERT
33154-18 33155-18
18,5 cm, 7 1/4"



BEYER
33156-18
18 cm, 7"



KLEINERT-KUTZ
15 cm, 6"

Hohlmeißelzangen
 Bone Rongeurs
 Pinzas-gubias
 Pinze sgorbie



BEYER
 33201-18
 18 cm, 7"



SMITH-PETERSEN
 24 cm, 9 1/2"



3 mm
 33157-04



4 mm
 33157-05



5 mm
 33157-06



3 mm
 33158-03



4 mm
 33158-04



5 mm
 33158-05



MAYFIELD
 33202-18
 18 cm, 7"

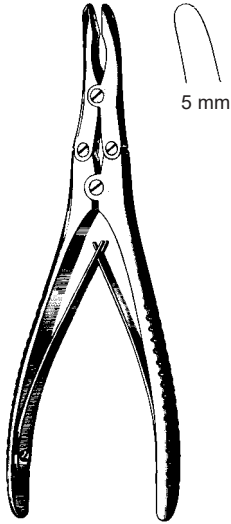


ZAUFAL-JANSEN
 33205-18
 18 cm, 7"

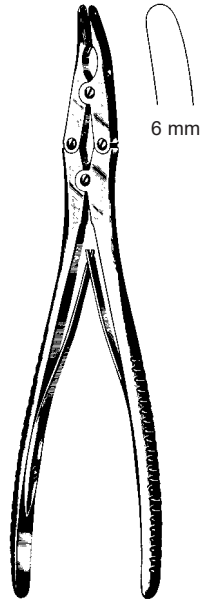


BÖHLER
 33211-15 33213-15
 15 cm, 6"

Hohlmeißelzangen
Bone Rongeurs
Pinzas-gubias
Pinze sgorbie



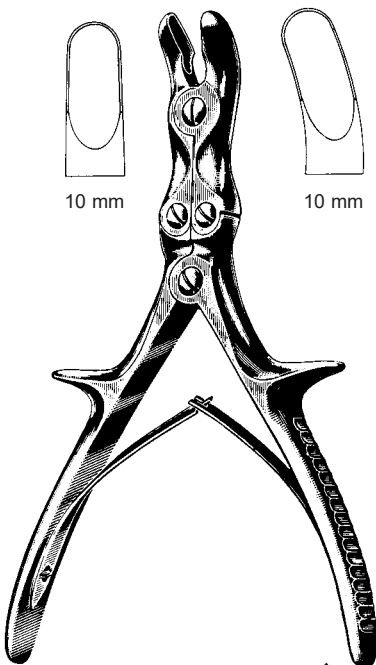
RUSKIN
33216-18 33217-18
18 cm, 7"



RUSKIN
33219-23 23 cm, 9"



MARQUARDT
33220-20 20 cm, 8"



STILLE-LUER
33230-22 22 cm, 8³/₄" 33231-22
33230-26 26 cm, 10¹/₄" 33231-26

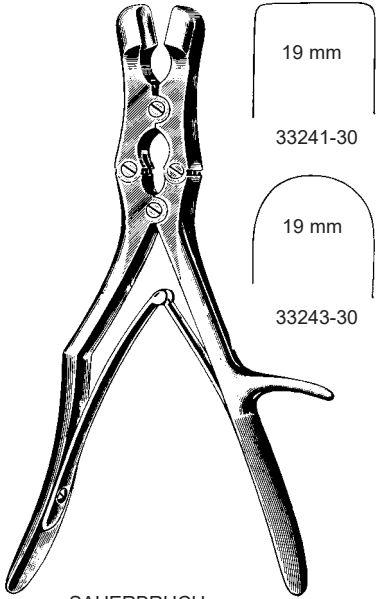


STILLE-LUER
33235-23
23 cm, 9"

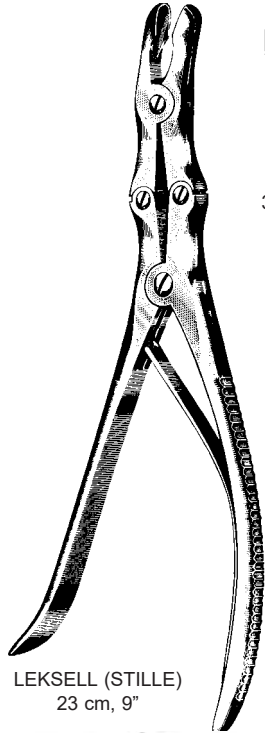
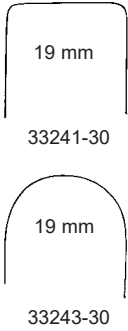


STILLE-RUSKIN
33237-23
23 cm, 9"

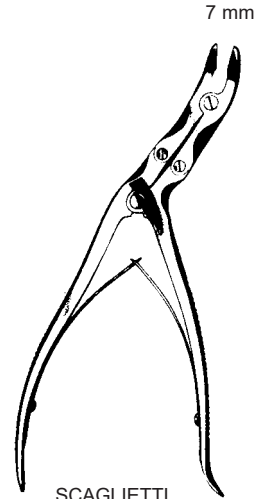
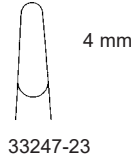
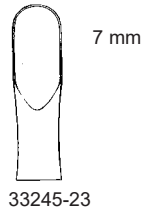
Hohlmeißelzangen
 Bone Rongeurs
 Pinzas-gubias
 Pinze sgorbie



SAUERBRUCH
 30 cm, 11³/₄"



LEKSELL (STILLE)
 23 cm, 9"



SCAGLIETTI
 26 cm, 10¹/₄"
 33251-26 rechts right derecha a destra
 33253-26 links left izquierda a sinistra



ECHLIN
 33257-23 2 mm
 33258-23 4 mm
 33259-23 3 mm
 23 cm, 9"

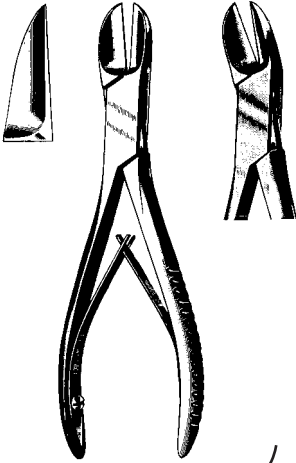


FRYKHOLM
 33260-24
 24 cm, 9¹/₂"



SEMB
 33261-22
 22,5 cm, 8,9"

Knochensplitterzangen
 Bone Cutting Forceps
 Pinzas cortantes para huesos
 Cesioie per ossa



LISTON

33274-14 14 cm, 5½" 33275-14
 33274-17 17 cm, 6¾" 33275-17
 33274-19 19 cm, 7½" 33275-19
 33274-22 22 cm, 8¾" 33275-22



BÖHLER

33280-15 33281-15
 15 cm, 6"



COTTLE-KAZANJIAN

33282-19
 19 cm, 7½"



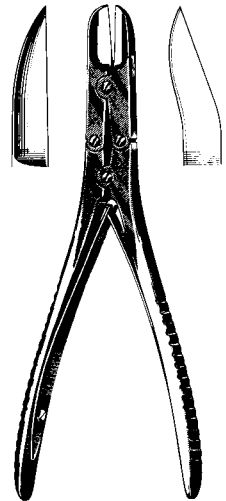
MC INDOE

33283-17
 17 cm, 6¾"



STAMM

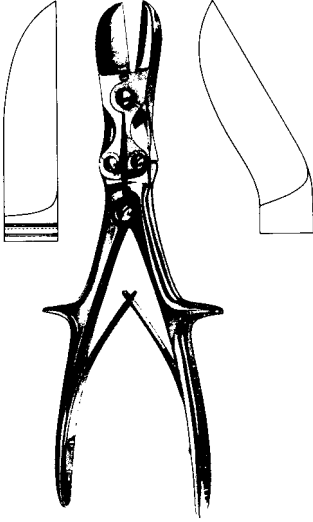
33284-15
 15 cm, 6"



RUSKIN-LISTON

33286-18 33289-18
 18 cm, 7"

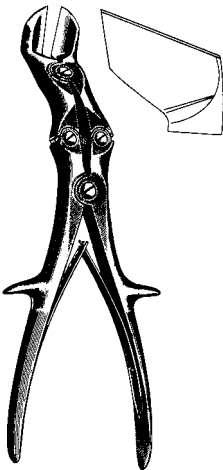
Knochensplitterzangen
 Bone Cutting Forceps
 Pinzas cortantes para huesos
 Cesoie per ossa



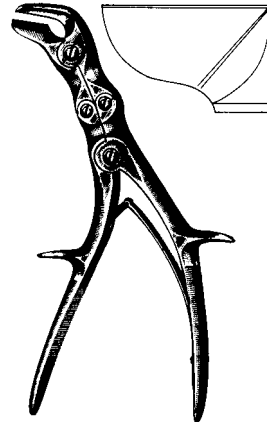
— STILLE-LISTON —
 33290-23 23 cm, 9" 33291-23
 33290-27 27 cm, 10¹/₂" 33291-27



STILLE-LISTON
 33292-26
 26 cm, 10¹/₄"

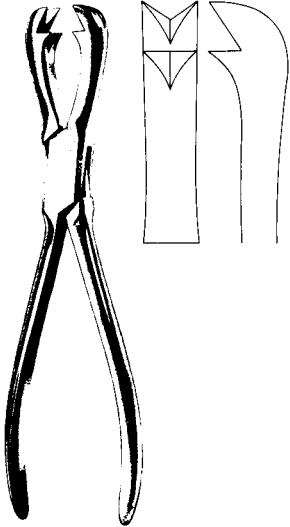


STILLE-HORSLEY
 33293-27
 27 cm, 10¹/₂"

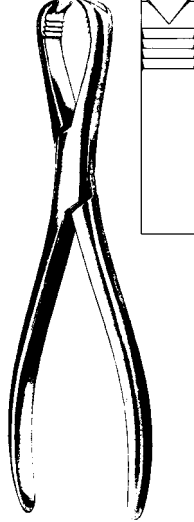


SEMB
 33295-24
 24 cm, 9¹/₂"

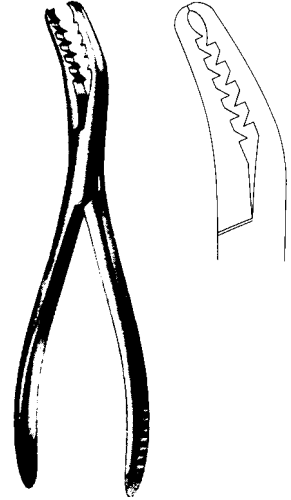
Knochenhaltezangen
Bone Holding Forceps
Pinzas para huesos
Tenaglie per ossa



FERGUSON
33360-21
21 cm, 8¹/₄"



LANGENBECK
33362-21
21 cm, 8¹/₄"



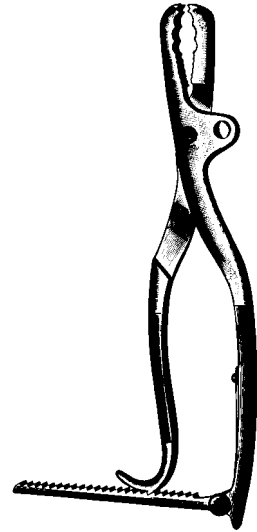
SEMB
33365-19
19 cm, 7¹/₂"



SEMB
33366-19
20 cm, 8"

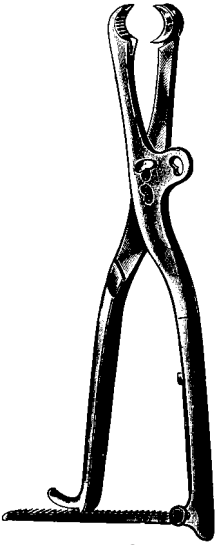


FARABEUF
33366-23 23 cm, 9"
33366-26 26 cm, 10¹/₄"



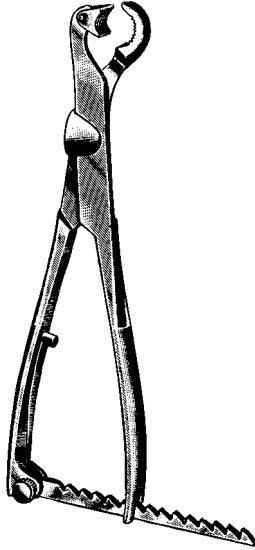
FARABEUF-LAMBOTTE
33368-26
26 cm, 10¹/₄"

Knochenhalte­zangen
Bone Holding Forceps
Pinzas para huesos
Tenaglie per ossa



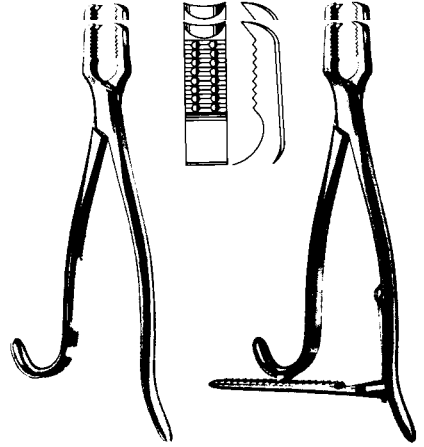
LAMBOTTE

33370-22 22 cm, 8 $\frac{1}{4}$ "
33370-27 27 cm, 10 $\frac{1}{2}$ "
33370-30 30 cm, 11 $\frac{1}{4}$ "



LAMBOTTE

33372-22 22 cm, 8 $\frac{3}{4}$ "
33372-26 26 cm, 10 $\frac{1}{4}$ "
33372-33 33 cm, 13"



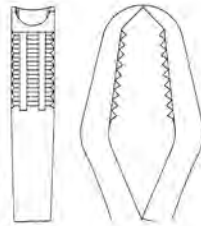
KERN

33378-15 11 cm, 4 $\frac{1}{4}$ " 33380-11
33378-17 15 cm, 6" 33380-15
33378-21 17 cm, 6 $\frac{3}{4}$ " 33380-17
21 cm, 8 $\frac{1}{4}$ " 33380-21
24 cm, 9 $\frac{1}{2}$ " 33380-24



LANE

33382-33 33 cm, 13"
33382-45 45 cm, 17 $\frac{3}{4}$ "



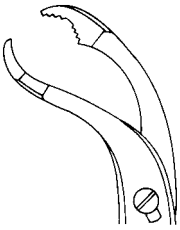
LANE

33384-33 33 cm, 13"
33384-45 45 cm, 17 $\frac{3}{4}$ "

Knochenhaltezangen
Bone Holding Forceps
Pinzas para huesos
Tenaglie per ossa

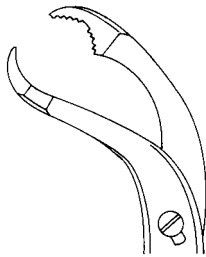
selbstzentrierend
self-centering
autocentrantes
autocentranti

9,5 mm



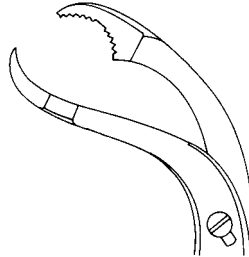
33391-24
24 cm, 9 1/2"

10 mm



33391-26
26 cm, 10 1/4"

11 mm



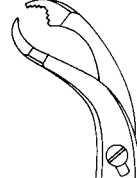
33391-28
28 cm, 11"

2,5 mm

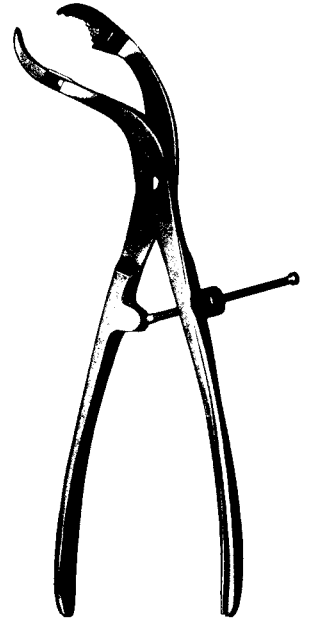


33391-15
15 cm, 6"

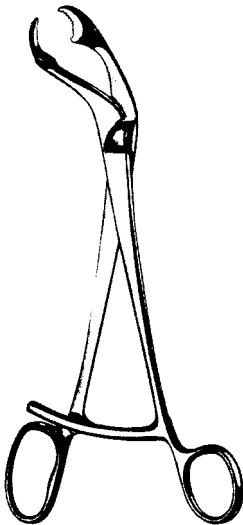
6,5 mm



33391-19
19 cm, 7 1/2"



33391-15 - 33391-28



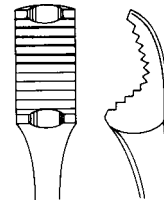
VERBRUGGE
33395-17 - 33395-27

5 mm



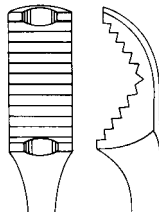
33395-17
17,5 cm, 7"

9,5 mm



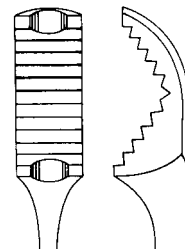
33395-25
25 cm, 10"

10,5 mm



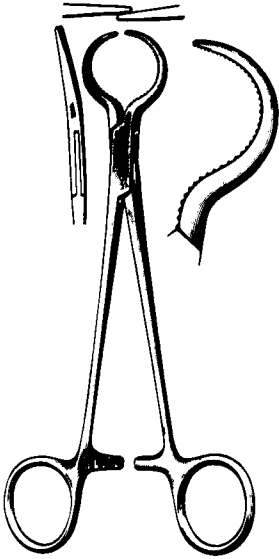
33395-26
26 cm, 10 1/4"

12 mm

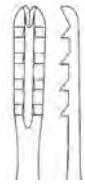


33395-27
27 cm, 10 1/2"

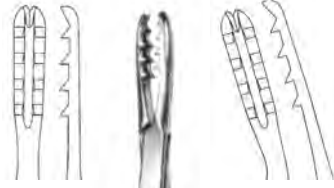
Knochenhaltezangen
Bone Holding Forceps
Pinzas para huesos
Tenaglie per ossa



LEWIN
33402-17
17,5 cm, 7"



33404-20



33405-20



BIRCHER-GANSKE
20 cm, 8"



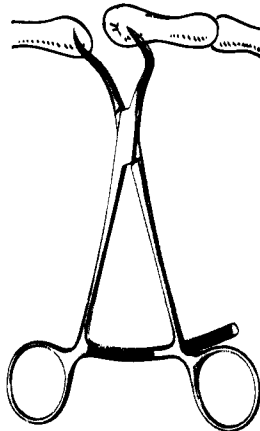
MARTIN
33410-19
19 cm, 7 1/2"



33406-20
20 cm, 8"



33407-13
13,5 cm, 5 1/4"



REDA
33409-13
13,5 cm, 5 1/4"

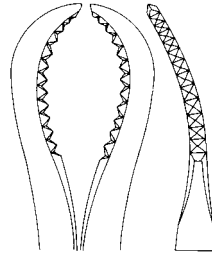


DINGMANN
33407-19
19 cm, 7 1/2"

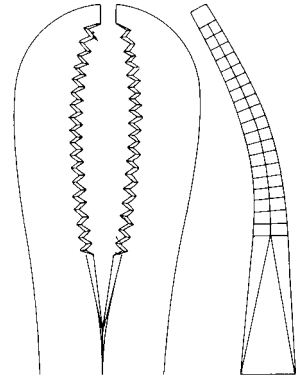
Knochenhaltezangen
Bone Holding Forceps
Pinzas para huesos
Tenaglie per ossa



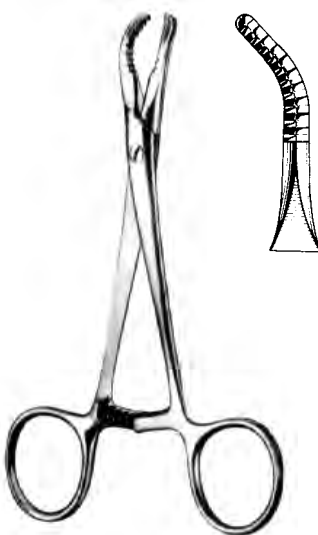
REDA
33412-16 - 33412-24



33412-16
16 cm, 6 1/4"



33412-24
24 cm, 9 1/2"

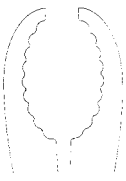


REDA
33413-14
13,5 cm, 5 1/4"

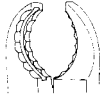


33414-21
21 cm, 8 1/4"

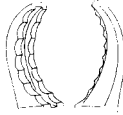
Knochenhaltezangen
Bone Holding Forceps
Pinzas para huesos
Tenaglie per ossa



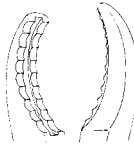
ULRICH
33415-23 - 33415-28



33415-23
23 cm, 9"



33415-25
25 cm, 10"



33415-28
28 cm, 11"



REILL
33416-17 17 cm, 6³/₄"



PATELLA
33417-18 18,5 cm, 7¹/₄"

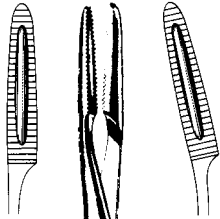


MEYER
33418-17 17 cm, 6³/₄"

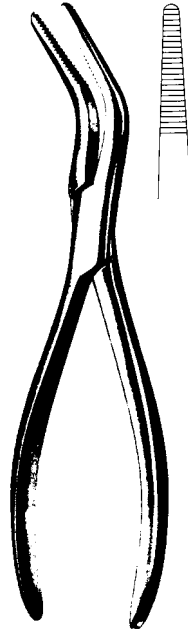


MEYER
33419-20 20,5 cm, 8"

Knochenhalte­zangen, -Klammern
 Bone holding forceps, -Clamps
 Pinzas para huesos, Clamps porta-huesos
 Tenaglie per ossa, Pinze per ossa



33420-20 33421-20
 20 cm, 8"



VAN BUREN
 33423-23
 23 cm, 9"



FELDHEIM
 33424-10
 10 cm, 4"

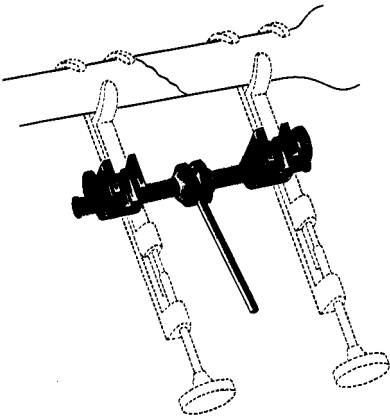


LOWMAN
 33441-13 13 cm, 5¹/₈"
 33441-18 18 cm, 7"
 33441-20 20 cm, 8"



LAMBERT-LOWMAN
 33443-18
 18 cm, 7"

Knochenhaltezaugen, Bleihand
 Bone holding forceps, Lead Hands
 Pinzas para huesos, Manoplas de plomo
 Tenaglie per ossa, Mani di piombo



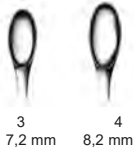
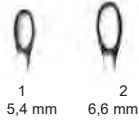
GERSTER
33444-15



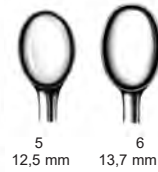
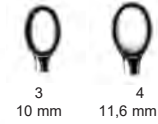
33450-01
 32 cm, 12 3/4"
 Erwachsen
 adult size
 p. adultos
 p. adulti

33450-02
 24 cm, 9 1/2"
 Kind
 child size
 p. niños
 p. bambini

Scharfe Löffel
Bone Curettes
Cucharillas cortantes
Curette taglienti



SCHEDE	Fig.	VOLKMANN
	0000	33469-96
33467-97	000	33469-97
33467-98	00	33469-98
33468-00	0	33470-00
33468-01	1	33470-01
33468-02	2	33470-02
33468-03	3	33470-03
33468-04	4	33470-04
	5	33470-05
	6	33470-06



VOLKMANN

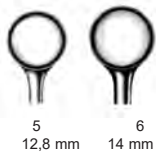
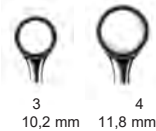
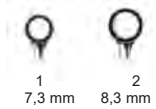
17 cm, 6³/₄"

33469-96 - 33470-06

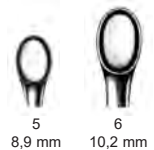
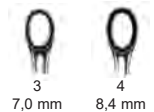
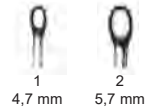
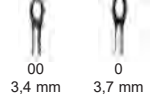
SCHEDE

17 cm, 6³/₄"

33467-97 - 33468-04



BRUNS	Fig.	SPRATT
33471-96	0000	33474-96
33471-97	000	33474-97
33471-98	00	33474-98
33472-00	0	33475-00
33472-01	1	33475-01
33472-02	2	33475-02
33472-03	3	33475-03
33472-04	4	33475-04
33472-05	5	33475-05
33472-06	6	33475-06



SPRATT

17 cm, 6³/₄"

33474-97 - 33475-06

BRUNS

17 cm, 6³/₄"

33471-96 - 33472-06

Scharfe Löffel
Bone Currettes
Cucharillas cortantes
Curette taglianti



COBB
27,9 cm, 11"

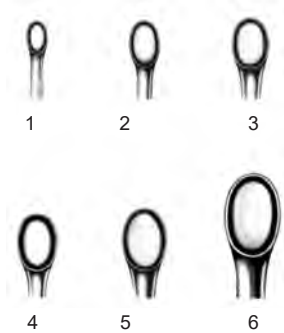


Fig.

1	33473-01	3,5 mm
2	33473-02	4,5 mm
3	33473-03	5,5 mm
4	33473-04	7,5 mm
5	33473-05	8,5 mm
6	33473-06	10,0 mm

Scharfe Löffel
Bone Currettes
Cucharillas cortantes
Curette taglianti



- Fig.
1 33476-01 4,8 mm
2 33476-02 5,8 mm
3 33476-03 6,8 mm

biegsam
malleable
maleable
malleabile

HALLÉ

21 cm, 8 1/4"

33476-01 - 33476-02

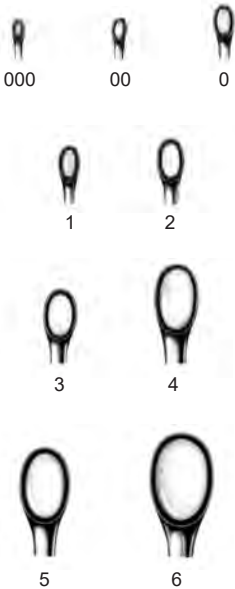


- Fig.
000 33476-98 2,8 mm
00 33476-99 3,3 mm
0 33477-00 3,7 mm
1 33477-01 4,3 mm
2 33477-02 4,8 mm
3 33477-03 5,6 mm
4 33477-04 6,1 mm
5 33477-05 6,7 mm
6 33477-06 8,8 mm

SPINAL

20 cm, 8"

33476-98 - 33477-06



- Fig.
000 33478-98 2,8 mm
00 33478-99 3,3 mm
0 33479-00 3,7 mm
1 33479-01 4,3 mm
2 33479-02 4,8 mm
3 33479-03 5,6 mm
4 33479-04 6,1 mm
5 33479-05 6,7 mm
6 33479-06 8,8 mm



SPINAL
20 cm, 8"

33478-98 - 33479-06



SCOVILLE
25 cm, 10"

33482-01 - 33482-03



Scharfe Löffel
Bone Currettes
Cucharillas cortantes
Curette taglienti

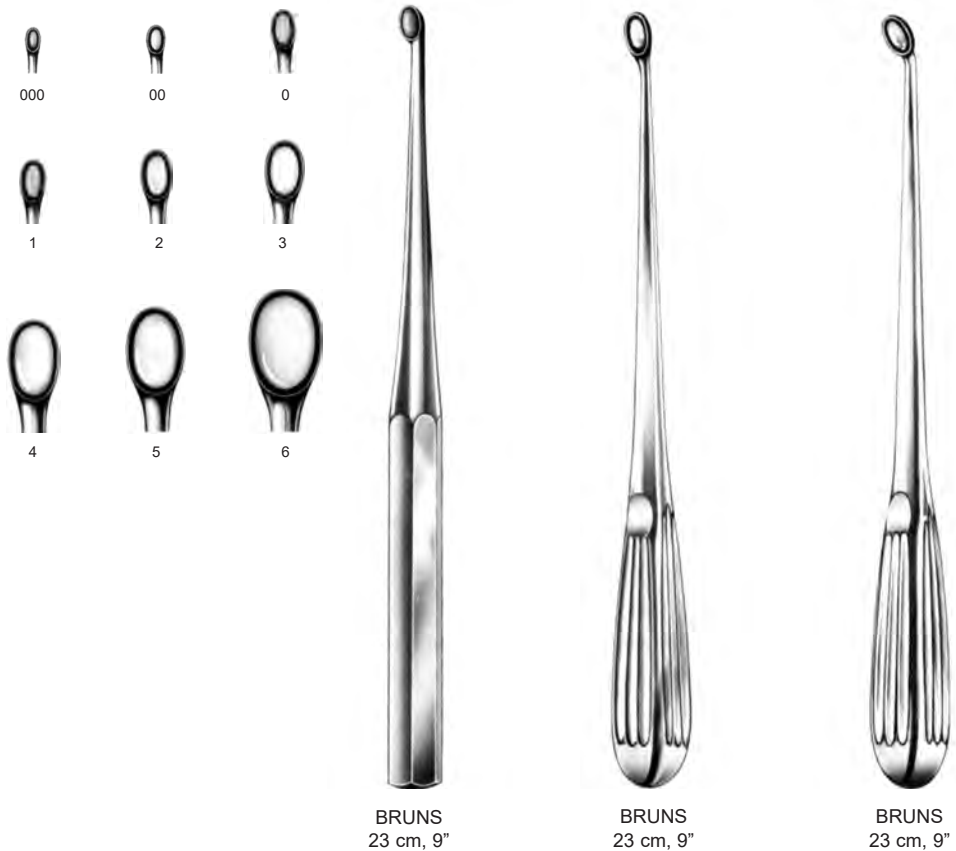
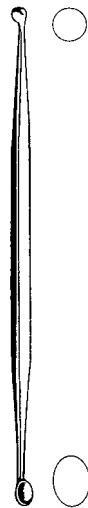


Fig.						
000	33480-97	2,0 mm	33482-97	2,8 mm	33484-97	2,8 mm
00	33480-98	2,5 mm	33482-98	3,3 mm	33484-98	3,3 mm
0	33481-00	3,3 mm	33483-00	3,7 mm	33485-00	3,7 mm
1	33481-01	3,8 mm	33483-01	4,3 mm	33485-01	4,3 mm
2	33481-02	4,8 mm	33483-02	4,8 mm	33485-02	4,8 mm
3	33481-03	5,3 mm	33483-03	5,6 mm	33485-03	5,6 mm
4	33481-04	6,0 mm	33483-04	6,1 mm	33485-04	6,1 mm
5	33481-05	6,7 mm	33483-05	6,7 mm	33485-05	6,7 mm
6	33481-06	7,3 mm	33483-06	8,8 mm	33485-06	8,8 mm

Scharfe Löffel
Bone Currettes
Cucharillas cortantes
Curette taglianti



33485-21 21 cm, 8 1/4"
oval/rund
ovale/ronde
ovalado/redondo
ovale/rotonda



WILLIGER
17,5 cm, 7"

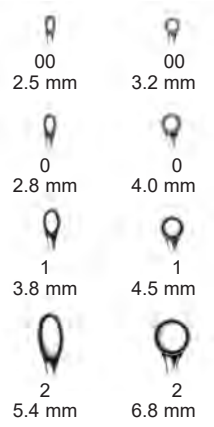


Fig. 00	33485-99	33486-99
0	33486-00	33487-00
1	33486-01	33487-01
2	33486-02	33487-02



DAUBENSPECK
20 cm, 8"



Fig. 00	33487-99
0	33488-00
1	33488-01
2	33488-02



27 cm, 10 1/2"



Fig. 0	33489-00
1	33489-01
2	33489-02
3	33489-03

Scharfe Löffel
 Bone Currettes
 Cucharillas cortantes
 Curette taglienti



LEMPERT
 17,5 cm, 7"



Fig. 0	33490-10	3,3 mm
00	33490-20	3,0 mm
000	33490-30	2,7 mm
0000	33490-40	2,4 mm
00000	33490-50	2,0 mm



RED A
 25 cm, 10"

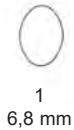
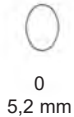
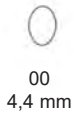


Fig. 000	33491-05
00	33491-06
0	33491-07
1	33491-08



RED A
 25 cm, 10"

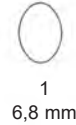
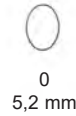
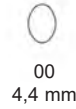
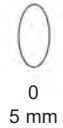
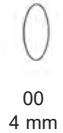
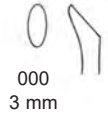


Fig. 000	33500-01
00	33500-02
0	33500-03

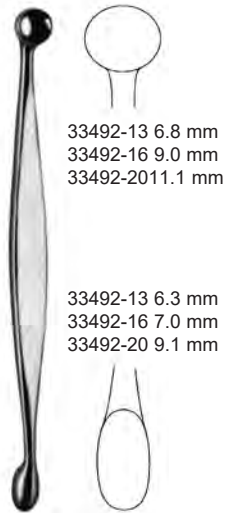


BUSHE
 25 cm, 10"

Fig. 000	33491-01
00	33491-02
0	33491-03
1	33491-04



Scharfe Löffel
 Bone Curettes
 Cucharillas cortantes
 Curette taglienti



33492-13 6.8 mm
 33492-16 9.0 mm
 33492-2011.1 mm

33492-13 6.3 mm
 33492-16 7.0 mm
 33492-20 9.1 mm

VOLKMANN

33492-13 13 cm, 5 1/8"
 33492-16 16 cm, 6 1/4"
 33492-20 20 cm, 8"



33494-13 7.5 mm
 33494-14 6.8 mm
 33494-17 6.8 mm

33494-13 6.3 mm
 33494-14 6.2 mm
 33494-17 7.3 mm

VOLKMANN

33494-13 13 cm, 5 1/8"
 33494-14 14 cm, 5 1/2"
 33494-17 17 cm, 6 3/4"

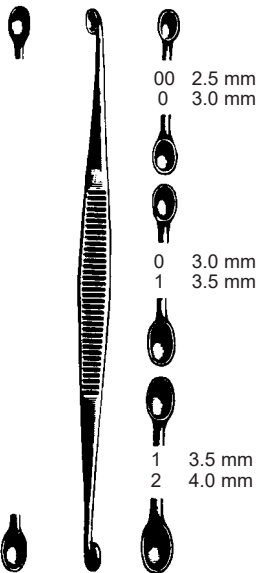


5.2 mm

3.5 mm

JANSEN

33495-16
 16 cm, 6 1/4"



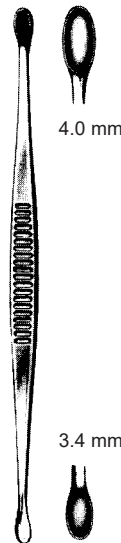
00 2.5 mm
 0 3.0 mm

0 3.0 mm
 1 3.5 mm

1 3.5 mm
 2 4.0 mm

WILLIGER

13,5 cm, 5 1/4" Fig.
 33496-00 00/0
 33496-01 0/1
 33496-12 1/2

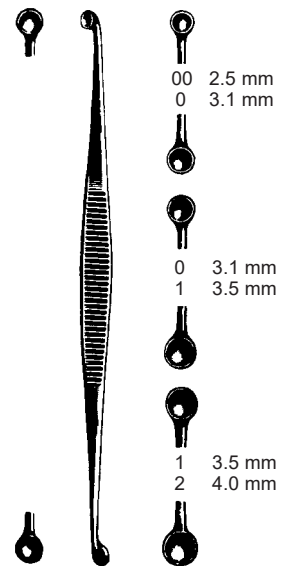


4.0 mm

3.4 mm

JACOBSON

13 cm, 5 1/8"
 33497-00



00 2.5 mm
 0 3.1 mm

0 3.1 mm
 1 3.5 mm

1 3.5 mm
 2 4.0 mm

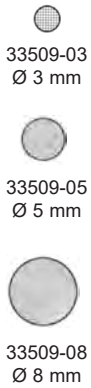
MARTINI

13,5 cm, 5 1/4"
 33498-00
 33498-01
 33498-12

Stößel
Hemostats
Hemostáticos
Pistoni



CASPAR
20 cm, 8"



20 cm, 8"



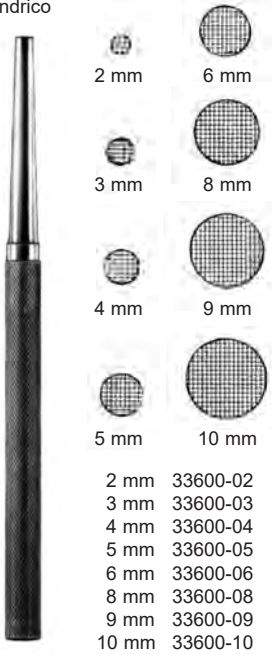
doppelt zylindrisch
double cylindrical
doble cilíndrica
doppio cilindrico



Ø 8 x 15 mm 33520-08 16 cm, 6 ¼"
Ø 6 x 8 mm 33520-06 21 cm, 8 ¾"
Ø 10 x 10 mm 33520-10 21 cm, 8 ¾"

Stößel, Flachmeißel, Hohlmeißel, Osteotome
 Hemostats, Chisels, Gouges, Osteotome
 Hemostáticos, Cinceles, Gubias, Osteótomo
 Pistoni, scalpelli, sgorbie, Osteotomia

zylindrisch
 cylindrical
 cilindrico
 cilindrico



16 cm, 6 1/4"

2 mm	33600-02
3 mm	33600-03
4 mm	33600-04
5 mm	33600-05
6 mm	33600-06
8 mm	33600-08
9 mm	33600-09
10 mm	33600-10



13,5 cm, 5 1/4"

4 mm	33602-04
6 mm	33602-06
8 mm	33602-08
10 mm	33602-10
12 mm	33602-12
14 mm	33602-14
16 mm	33602-16



13,5 cm, 5 1/4"

33604-04
33604-06
33604-08
33604-10
33604-12
33604-14
33604-16



13,5 cm, 5 1/4"

33605-04
33605-06
33605-08
33605-10
33605-12
33605-14
33605-16



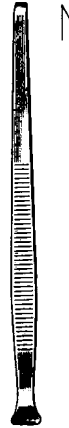
ALEXANDER
 17 cm, 6 3/4"

33610-04	4 mm
33610-06	6 mm
33610-08	8 mm
33610-10	10 mm
33610-12	12 mm
33610-14	14 mm



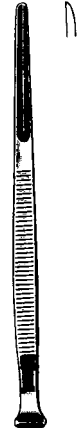
ALEXANDER
 17 cm, 6 3/4"

33611-04	4 mm
33611-06	6 mm
33611-08	8 mm
33611-10	10 mm
33611-12	12 mm
33611-14	14 mm



PARTSCH
 13,5 cm, 5 1/4" mm 17 cm, 6 3/4"

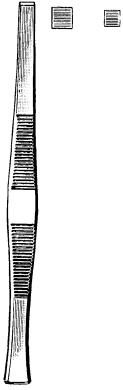
33620-02	2	33622-02
33620-03	3	33622-03
33620-04	4	33622-04
33620-05	5	33622-05
33620-06	6	33622-06
33620-07	7	33622-07
33620-08	8	33622-08



PARTSCH
 13,5 cm, 5 1/4" mm 17 cm, 6 3/4"

33623-02	2	33625-02
33623-03	3	33625-03
33623-04	4	33625-04
33623-05	5	33625-05
33623-06	6	33625-06
33623-07	7	33625-07
33623-08	8	33625-08

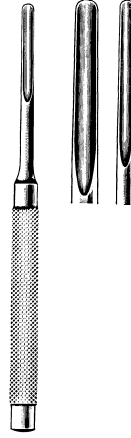
Flachmeißel, Hohlmeißel, Osteotome
 Chisels, Gouges, Osteotome
 Cinceles, Gubias, Osteótomo
 Scalpelli, sgorbie, Osteotomia



PASSOW
 12 cm, 4 3/4"
 33626-35 3,5 mm
 33626-25 2,5 mm



BRÜNINGS-LUCAS
 16 cm, 6 1/4"
 33627-04 4 mm
 33627-06 6 mm



BRÜNINGS-LUCAS
 16 cm, 6 1/4"
 33628-03 3 mm
 33628-05 5 mm



STILLE
 20 cm, 8"
 6 mm 33630-06
 8 mm 33630-08
 10 mm 33630-10
 12 mm 33630-12
 15 mm 33630-15
 20 mm 33630-20
 25 mm 33630-25
 30 mm 33630-30



STILLE
 20 cm, 8"

6 mm 33632-06
 8 mm 33632-08
 10 mm 33632-10
 12 mm 33632-12
 15 mm 33632-15
 20 mm 33632-20
 25 mm 33632-25
 30 mm 33632-30



STILLE
 20 cm, 8"

6 mm 33633-06
 8 mm 33633-08
 10 mm 33633-10
 12 mm 33633-12
 15 mm 33633-15
 20 mm 33633-20
 25 mm 33633-25
 30 mm 33633-30



STILLE
 20 cm, 8"

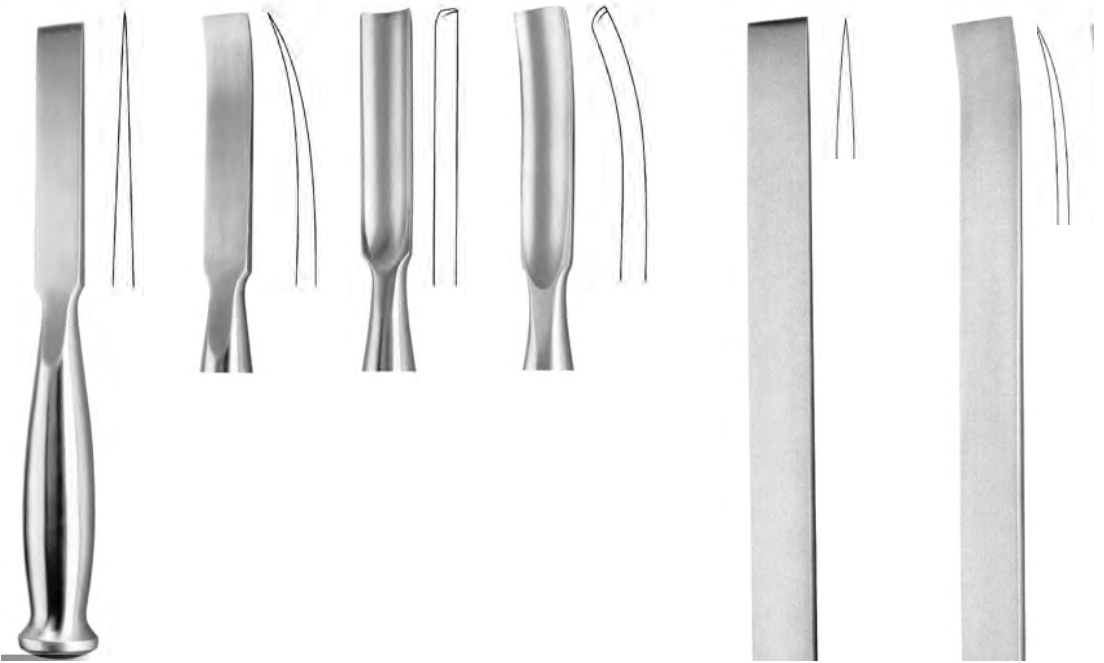
6 mm 33634-06
 8 mm 33634-08
 10 mm 33634-10
 12 mm 33634-12
 15 mm 33634-15
 20 mm 33634-20
 25 mm 33634-25
 30 mm 33634-30



STILLE
 20 cm, 8"

6 mm 33634-06
 8 mm 33634-08
 10 mm 33634-10
 12 mm 33634-12
 15 mm 33634-15
 20 mm 33634-20
 25 mm 33634-25
 30 mm 33634-30

Osteotome, Hohlmeißel
 Osteotome, Gouges
 Osteótomo, Gubias
 Osteotomia, sgorbie



SMITH-PETERSEN
 20 cm, 8"

6 mm	33644-06	33645-06	33647-06	
9 mm	33644-09	33645-09	33647-09	33649-09
13 mm	33644-13	33645-13		
14 mm			33647-14	33649-14
16 mm	33644-16	33645-16	33647-16	33649-16
19 mm	33644-19	33645-19	33647-19	33649-19
25 mm	33644-25	33645-25	33647-25	33649-25
32 mm	33644-32	33645-32	33647-32	33649-32

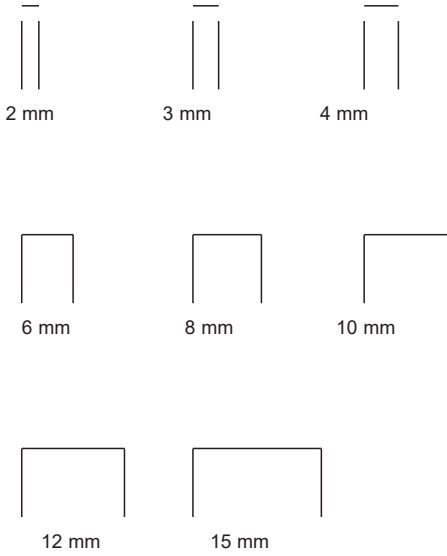
LAMBOTTE
 24 cm, 9 1/2"

33650-04	4 mm	33651-04
33650-06	6 mm	33651-06
33650-08	8 mm	33651-08
33650-10	10 mm	33651-10
33650-13	13 mm	33651-13
33650-16	16 mm	33651-16
33650-18	18 mm	33651-18
33650-20	20 mm	33651-20
33650-25	25 mm	33651-25
33650-30	30 mm	33651-30
33650-38	38 mm	33651-38
33650-44	44 mm	33651-44
33650-50	50 mm	33651-50

Osteotome, Hohlmeißel
 Osteotome, Chisels, Gouges
 Osteótomo, Cinceles, Gubias
 Osteotomia, Scalpelli, sgorbie



MINI-LAMBOTTE



12,5 cm, 5"	mm	17 cm, 6 3/4"
33654-02	2	33652-02
33654-03	3	33652-03
33654-04	4	33652-04
33654-06	6	33652-06
33654-08	8	33652-08
33654-10	10	33652-10
33654-12	12	33652-12
33654-15	15	33652-15

8 mm 8 mm 8 mm 8 mm



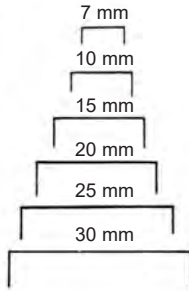
COBB	COBB	COBB	COBB
28 cm, 11"	28 cm, 11"	28 cm, 11"	28 cm, 11"
33656-28	33657-28	33658-28	33659-28

mit Ferrozellgriff
 with Ferrozell-Handle
 con mango de Ferrozell
 con manico di Ferrozell

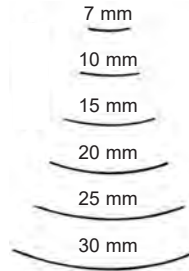
Osteotome und Hohlmeißel mit Ferrozell-Griff
 Osteotome and Gouges with Ferrozell-Handle
 Osteótomo, Gubias con mango de Ferrozell
 Osteotomo, con manico di Ferrozell



LEXER
 22 cm, 8 3/4"



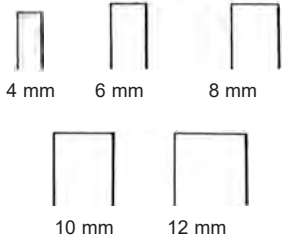
33660-07	7 mm	33661-07
33660-10	10 mm	33661-10
33660-15	15 mm	33661-15
33660-20	20 mm	33661-20
33660-25	25 mm	33661-25
33660-30	30 mm	33661-30



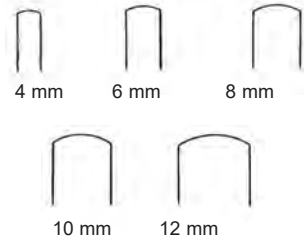
LEXER
 22 cm, 8 3/4"



LEXER MINI
 18 cm, 7"



33664-04	4 mm	33665-04
33664-06	6 mm	33665-06
33664-08	8 mm	33665-08
33664-10	10 mm	33665-10
33664-12	12 mm	33665-12



LEXER MINI
 18 cm, 7"

Flachmeißel, Hohlmeißel
 Chisels, Gouges
 Cinceles, Gubias
 Scalpelli, sgorbie

mit Ferrozellgriff
 with Ferrozell-Handle
 con mango de Ferrozell
 con manico di Ferrozell



33665-24
 24,5 cm, 9 3/4"



33665-26
 26,5 cm, 10 1/2"

mit NOVOTEX-Griff
 with Novotex-Handle
 con mango de Novotex
 con manico di Novotex



ZIELKE 23 cm, 9"
 33665-55 5,5 mm
 33665-90 9,0 mm



22 cm, 8 3/4"
 33666-22



—	25 cm, 10"	—
33669-05	5 mm	33670-05
33669-10	10 mm	33670-10
33669-15	15 mm	33670-15

Osteotome, Flachmeißel, Hohlmeißel
 Osteotome, Chisels, Gouges
 Osteótomo, Cinceles, Gubias
 Osteotomia, Scalpelli, Sgorbie



HOKE
 14 cm, 5 1/2"
 33668-03 3 mm
 33668-05 5 mm
 33668-06 6 mm
 33668-08 8 mm
 33668-09 9 mm
 33668-13 13 mm
 33668-16 16 mm
 33668-19 19 mm



HIBBS
 24 cm, 9 1/2"
 33670-06 6 mm
 33670-09 9 mm
 33670-13 13 mm
 33670-16 16 mm
 33670-19 19 mm
 33670-25 25 mm
 33670-32 32 mm



HIBBS
 24 cm, 9 1/2"
 33671-06 6 mm
 33671-09 9 mm
 33671-13 13 mm
 33671-16 16 mm
 33671-19 19 mm
 33671-25 25 mm
 33671-32 32 mm



HIBBS
 24 cm, 9 1/2"
 33672-06 6 mm
 33672-09 9 mm
 33672-13 13 mm
 33672-16 16 mm
 33672-19 19 mm
 33672-25 25 mm
 33672-32 32 mm



HIBBS
 24 cm, 9 1/2"
 33673-06 6 mm
 33673-09 9 mm
 33673-13 13 mm
 33673-16 16 mm
 33673-19 19 mm
 33673-25 25 mm
 33673-32 32 mm

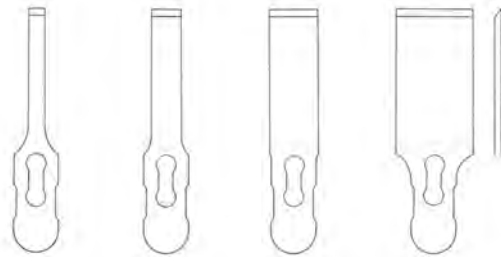


HIBBS
 24 cm, 9 1/2"
 33675-06 6 mm
 33675-09 9 mm
 33675-13 13 mm
 33675-16 16 mm
 33675-19 19 mm
 33675-25 25 mm
 33675-32 32 mm

Meißel
Chisels
Cinceles
Scalpelli



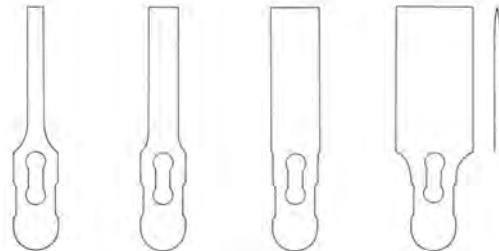
33676-02
9 cm, 3 1/2"
Spannschlüssel
Key
Llave
Clé
Chiave



5 mm 33676-05 8,5 mm, 3,4"	10 mm 33676-10 8,5 mm, 3,4"	16 mm 33676-16 8,5 mm, 3,4"	25 mm 33676-25 8,5 mm, 3,4"
----------------------------------	-----------------------------------	-----------------------------------	-----------------------------------

Meißelklingen
auswechselbar
Chisel blades
interchangeable
Hojas de cincel
intercambiables
Lame intercambiabili

33676-01
18,5 cm, 7 1/4"
Griff allein
Handle only
Mango suelto
Manico solo



5 mm 33677-05 8,5 mm, 3,4"	10 mm 33677-10 8,5 mm, 3,4"	16 mm 33677-16 8,5 mm, 3,4"	25 mm 33677-25 8,5 mm, 3,4"
----------------------------------	-----------------------------------	-----------------------------------	-----------------------------------

Osteotomklingen
auswechselbar
Osteotome blades
interchangeable
Hojas de osteótomo
intercambiables
Lame per osteotomia
intercambiabili

Sternummeißel, Osteotom, Schädelspalter, Rachiotom, Muskelhaken
 Sternum Chisel, Osteotome, Skull breaker, Rachiotome, Muscle hooks
 Cinceles de esternón, Osteotomo, Cíncel rompe-cráneo, Raquíótomos, Ganchos musculare
 Scalpello per sterno, Osteotomo, Divisore per cranio, Rachiotomi, Uncino per muscoli

23 mm



LEBSCHKE
 33678-24
 24,5 cm, 9 3/4"



33679-13
 13 cm, 5 1/8"



33680-22
 14 cm, 5 1/2"



33682-22
 22 cm, 8 3/4"

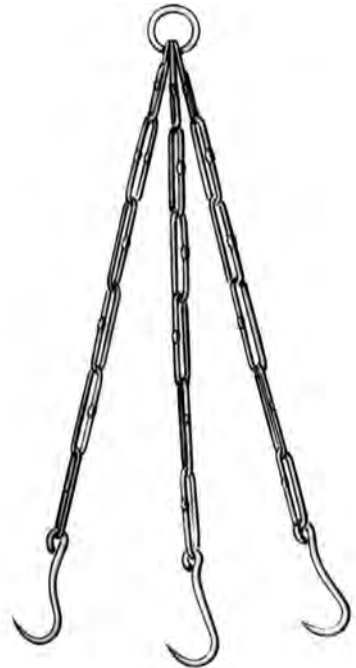
Tubulus



19901-00



19902-10
 10 cm, 4"

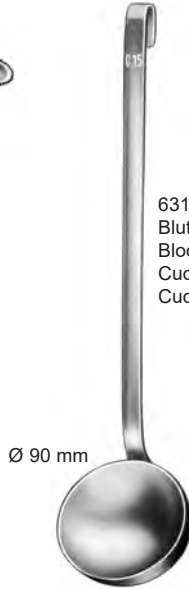


19903-00

Medizinlöffel, Meißel, Sektionsnadeln
 Medicine Spoon, Chisels, Post mortem needles
 Cuchara graduada, Cinceles, Aguja para autopsia
 Cucchiario per medicinali, Scalpelli, Aghi per autopsia



89146-20 20 cc
 110 x 20 mm



63174-00
 Blutschöpfer, 150 ccm
 Blood scoop, 9 cu. inches
 Cucharra p / sangre
 Cucchiario per sangue

Ø 90 mm



BRUNETTI
 28,5 cm, 11 ¼"
 33682-01 33682-02
 links rechts
 left right
 izquierdo derecho
 sinistra destra

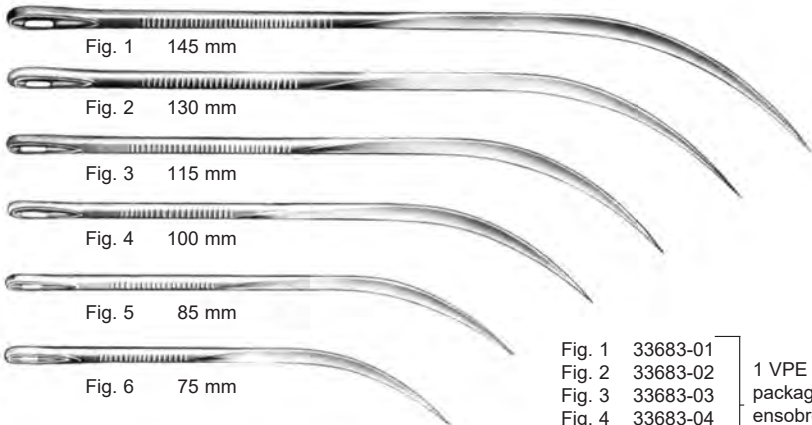


Fig. 1 145 mm

Fig. 2 130 mm

Fig. 3 115 mm

Fig. 4 100 mm

Fig. 5 85 mm

Fig. 6 75 mm

Fig. 1 33683-01
 Fig. 2 33683-02
 Fig. 3 33683-03
 Fig. 4 33683-04
 Fig. 5 33683-05
 Fig. 6 33683-06

1 VPE = 12 Stk.
 package of 12
 ensobres de 12
 confezione di 12

Obduktionsbesteck
Post Mortem Set
Estuches para Autopsia
Astucci per Autopsia



33684-00

Kleines Besteck, Holzetui, enthaltend:

- 4 Skalpelle
- 1 Knorpelmesser
- 1 Inzisionsschere, 13 cm (5 1/8")
- 1 Anatomische Pinzette, 13 cm (5 1/8")
- 1 Amputationssäge Charrière
- 1 Hammer
- 1 Meißel
- 2 doppelte Muskelhaken
- 2 doppelte Tubuli
- 2 Knopfsonden, 13 cm (5 1/8")
- 3 Wundnadeln

Small set, wooden case, containing:

- 4 Dissecting Knives
- 1 Cartilage Knife
- 1 Incision Scissors, 13 cm (5 1/8")
- 1 Dissecting Forceps, 13 cm (5 1/8")
- 1 Amputation Saw Charrière
- 1 Mallet
- 1 Chisel
- 2 Retractors, double ended
- 2 Blow pipes, double
- 2 Probes, 13 cm (5 1/8")
- 3 Suture Needles

Modelo pequeño, estuche de madera, conteniendo:

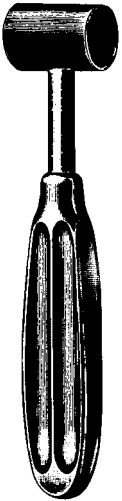
- 4 Escalpelos
- 1 Cuchillo para cartilago
- 1 Tijera de incision, 13 cm (5 1/8")
- 1 Pinza para disección, 13 cm (5 1/8")
- 1 Sierra de amputación Charrière
- 1 Martillo
- 1 Escoplo
- 2 Separadores de 2 ganchos, dobles
- 2 Tubos insufladores, dobles
- 2 Estiletos olivares, 13 cm (5 1/8")
- 3 Agujas para sutura

Modello piccolo, astuccio di legno, composto da:

- 4 Bisturi
- 1 Coltello per cartilagine
- 1 Forbice per incisione, 13 cm (5 1/8")
- 1 Pinza anatomica, 13 cm (5 1/8")
- 1 Sega per amputazione, Charrière
- 1 Martello
- 1 Scalpello
- 2 Divaricatori con 2 ganchi, doppi
- 2 Tubi inalatori, doppi
- 2 Specilli bottonuti, doppi, 13 cm (5 1/8")
- 3 Aghi per sutura

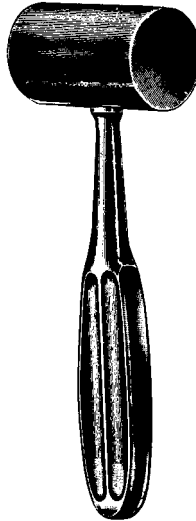
Hämmer
Mallets
Martillos
Martelli

Ø 25 mm



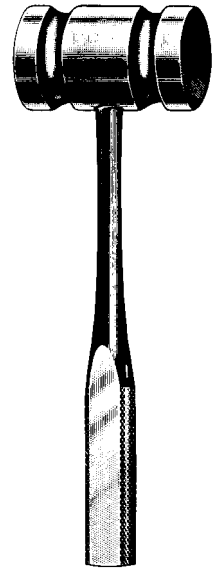
GERZOG
18 cm, 7"
33686-25 250 g

Ø 38 mm



KIRK
19 cm, 7 1/2"
33687-75 750 g

Ø 34 mm

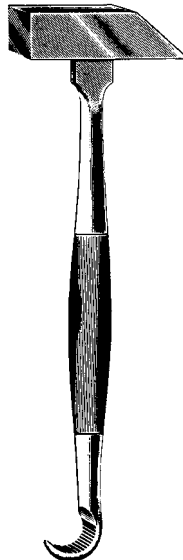


26,5 cm, 10 1/2"
33688-45 450 g
33689-90 900 g

Ø 30 mm



COLLIN
20 cm, 8"
33690-22 220 g



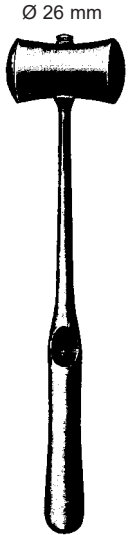
33699-00
23,5 cm, 9 1/4"
480 g

Ø 25 mm

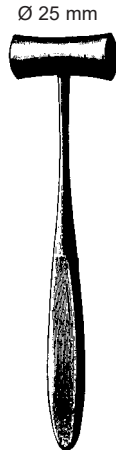


135 g
33694-01 18,5 cm, 7 1/4"
33694-03 Ersatzbacken
Nylon Caps
Tapas de repuesto
Placche di ricambio

Hämmer
Mallets
Martillos
Martelli



WILLIGER
24 cm, 9 1/2"
33691-34 340 g



LUCAE
19 cm, 7 1/2"
33692-26 260 g

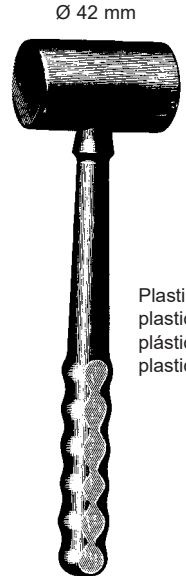


MEAD
17 cm, 6 3/4"
33693-32 320 g

massiv, mit auswechselbaren Ferrozellbacken
solid, with interchangeable Ferrozell jaws
macizo, con tapas intercambiables de Ferrozell
solido, con placche intercambiabili in Ferrozell

33693-33
Paar Ersatzbacken
Pair spare jaws
par de tapas de repuesto
Coppia di placche di ricambio

33693-34
Satz Ringe
Set rings
juego de anillos
Set anelli

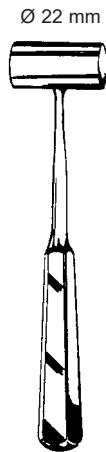


26 cm, 10 1/4"
33695-40 400 g

Plastik
plastic
plástico
plastica



QUISLING
33696-75
19 cm, 7 1/2"



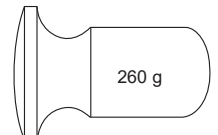
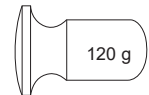
PARTSCH
33698-98
18 cm, 7"
199 g



33699-17
26,5 cm, 10 1/2"
530 g



DOYEN
21 cm, 8 1/4"



Hämmer
Mallets
Martillos
Martelli

Ø 30 mm



33700-01-01
Ersatzbacken
Nylon Caps
Tapas de repuesto
Placche di ricambio

24,5 cm, 9 3/4" 215 g
33700-01

Ø 10 mm

Ø 23 mm



Kopf aus Implantatwerkstoff
Head made of material used for implants
Cabeza de material de implantación
Testa in materiale per impianti

23 cm, 9" 350 g
33700-02

Ø 45 mm



BERGMANN
24 cm, 9 1/2" 300 g
33700-03

Ø 30 mm



BERGMANN
23 cm, 9" 300 g
33700-04

Hämmer
Bone Hammers and Mallets
Martillos y mazos
Martelli

Ø 30 mm



COTTLE
18 cm, 7" 240 g
33700-05

Ø 40 mm



HEATH
18 cm, 7" 700 g
33700-06

Ø 40 mm



OMBREDANNE
25 cm, 10" 700 g
33700-07

Ø 27 mm



HAJEK
21 cm, 8 1/4" 140 g
33700-08

Raspatorien
 Periosteal
 Periostótomos
 Periostotomi

12,5 mm



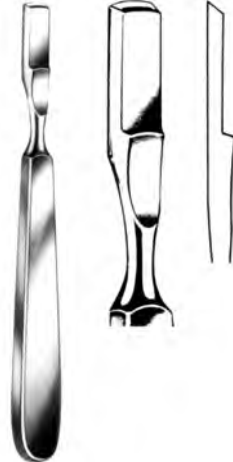
FARABEU
 33702-15
 15 cm, 5.9"

12,5 mm



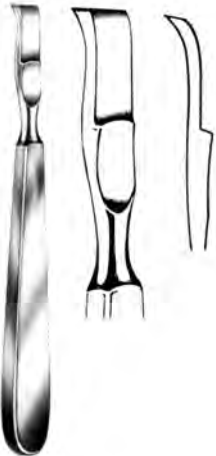
FARABEU
 33703-15
 15 cm, 5.9"

11 mm



FARABEU-COLLIN
 33704-01
 15,5 cm, 6"

11 mm



FARABEU-COLLIN
 33704-02
 15,5 cm, 6"



LAMBOTTE
 21 cm, 8 1/4"
 33705-05 5 mm
 33705-10 10 mm
 33705-15 15 mm
 33705-20 20 mm
 33705-25 25 mm

18 mm

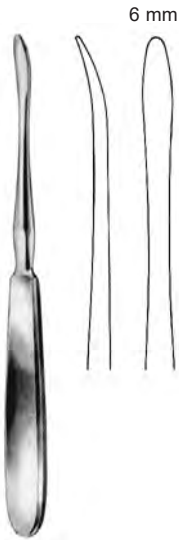


SEDILLOT
 18 cm, 7"
 33706-18

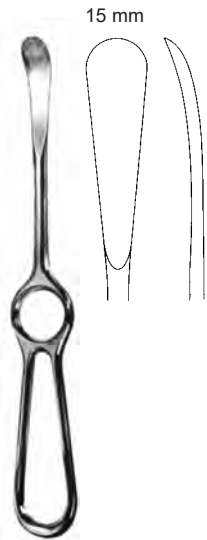
Elevatoren, Raspatorien
Elevatoren, Periosteal
Elevadores, Periostótomos
Elevatori, Periostotomi



SEBILEAU
17,5 cm, 7"
33707-17



QUERVAIN
19,5 cm, 7 3/4"
33708-19



SEDILLOT
21 cm, 8 1/4"
33709-21



LANGENBECK
19 cm, 7 1/2"
33710-19



LANGENBECK
18 cm, 7"
33711-18



LANGENBECK
20 cm, 8"
33711-20 8 mm
33711-21 10 mm

Raspatorien, Elevatoren
 Raspatories, Elevators
 Periostótomos, Elevadores
 Periostotomi, Elevatori

4 mm



WILLIGER
 33711-16
 16 cm, 6 ¼"

6,5 mm



WILLIGER
 33712-16
 16 cm, 6 ¼"

5 mm



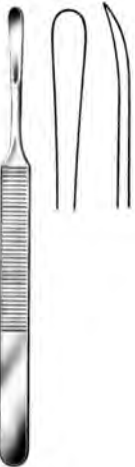
WILLIGER
 33713-16
 16 cm, 6 ¼"

5,5 mm



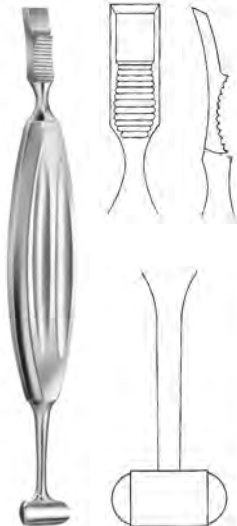
WILLIGER
 33713-17
 17 cm, 6 ¾"

5 mm



KÖNIG
 33714-15
 15,5 cm, 6"

12 mm

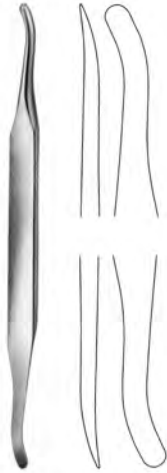


ALEXANDER
 33715-20
 21 cm, 8 ¼"

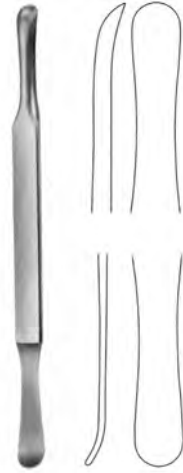


MOLT
 33716-18
 18 cm, 7"

Raspatorien, Elevatoren, Saugdissektor
 Raspatories, Elevators, Suction dissector
 Periostótomos, Elevadores, Disector con aspirador
 Periostotomi, Elevatori, Dissetto aspiratore



SELDIN
 33717-19-01
 19,5 cm 7 3/4"



SELDIN
 33717-19-02
 19,5 cm 7 3/4"



JOSEPH
 33718-16
 16 cm, 6 1/4"



FOMON
 33719-17
 17 cm, 6 3/4"



BOIES
 33720-19
 19 cm, 7 1/2"

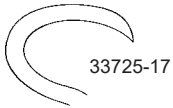
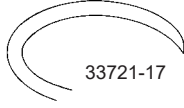


GORNEY
 33720-21
 21 cm, 8 1/4"

Raspatorien, Elevatoren
 Periosteal Elevators
 Periostótomos, Elevadores
 Periostotomi, Elevatori



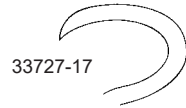
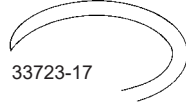
DOYEN
 17 cm, 6 ¾"



L



DOYEN
 17 cm, 6 ¾"



R



33728-24



33729-24

DOYEN
 24 cm 9 ½"



SEMB

12 mm



33729-01
 17,5 cm, 7"

12 mm



33729-02
 21 cm, 8 ¼"

12 mm



33729-03
 17,5 cm, 7"

13 mm



33729-04
 21 cm, 8"

15 mm

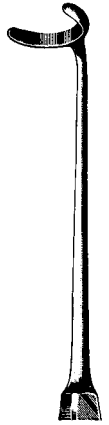


33729-05
 20,5 cm, 8"

15 mm

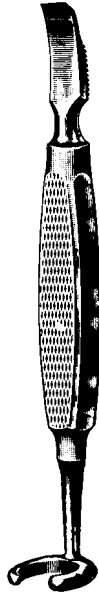


33729-06
 20,5 cm, 8"



33729-07
 22,5 cm, 8.9"

Elevatoren, Raspatoren
Elevators, Raspatories
Elevadores, Periostótomos
Elevatori, Periostotomi



MATSON-ALEXANDER
33731-22
22 cm, 8 3/4"



MATSON
33733-22
22 cm, 8 3/4"



33740-19
19 cm, 7 1/2"



33741-18
18,5 cm, 7 1/4"



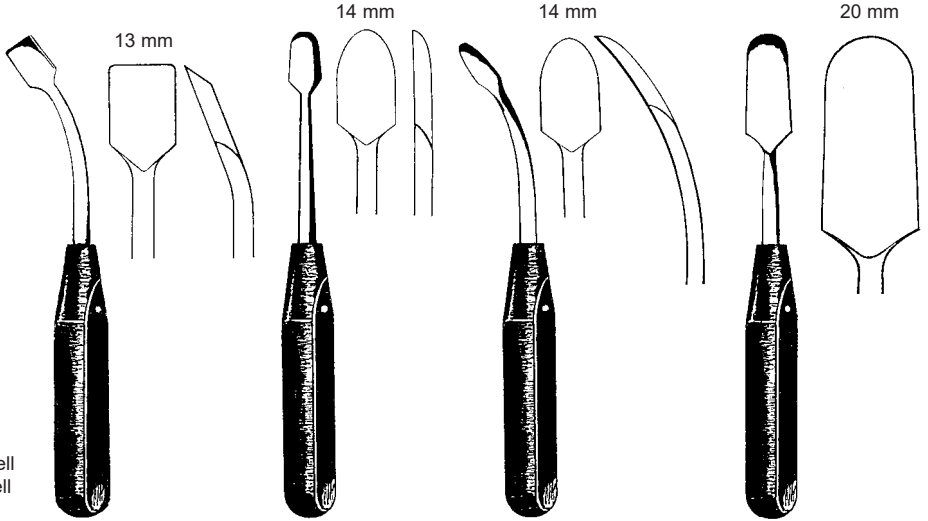
33742-18
18,5 cm, 7 1/4"



33743-18
18,5 cm, 7 1/4"

mit Ferrozellgriff
with Ferrozell-Handle
con mango de Ferrozell
con manico di Ferrozell

Elevatoren, Raspatoren
Elevators, Raspatories
Elevadores, Periostótomos
Elevatori, Periostotomi



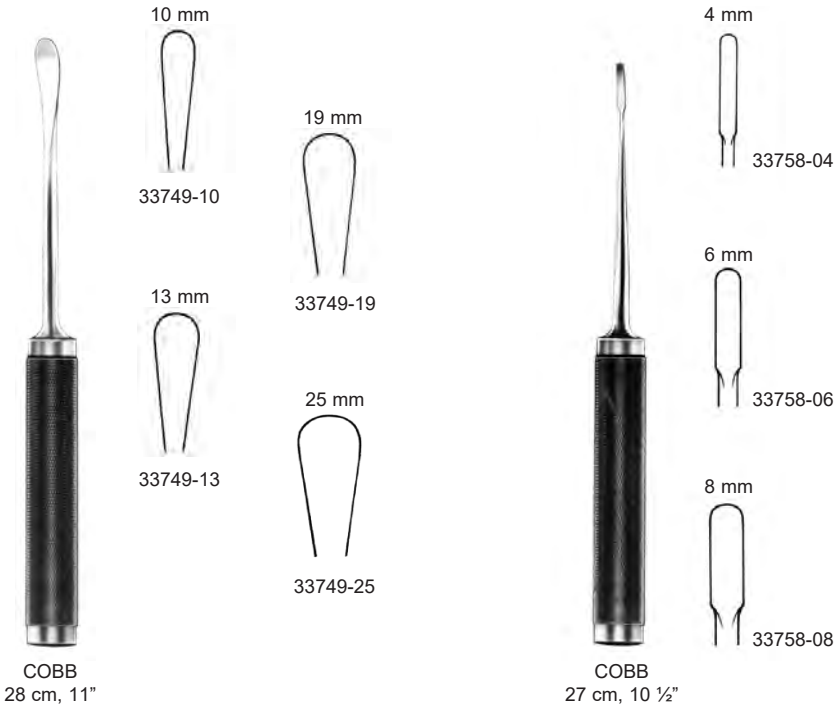
mit Ferrozellgriff
with Ferrozell-Handle
con mango de Ferrozell
con manico di Ferrozell

33745-19
18,5 cm, 7 1/4"

33746-19
19,5 cm, 7 3/4"

33747-18
18,5 cm, 7 1/4"

33748-20
20 cm, 8"



COBB
28 cm, 11"

COBB
27 cm, 10 1/2"

10 mm
33749-10

19 mm
33749-19

13 mm
33749-13

25 mm
33749-25

4 mm
33758-04

6 mm
33758-06

8 mm
33758-08

Elevatoren
Elevators
Elevadores
Elevatori

scharf
sharp
cortante
tagliante



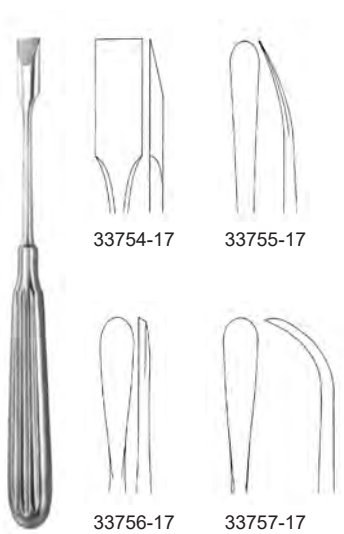
SAYRE
17 cm, 6 3/4"
33758-01

stumpf
blunt
romo
smusso



SAYRE
17 cm, 6 3/4"
33758-02

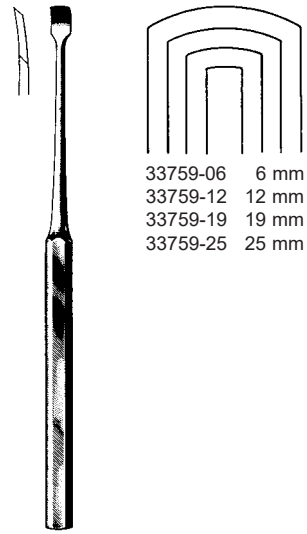
Raspatoren, Knochenheber, Dissektor
 Raspatories, Bone Levers, Dissectors
 Periostótomos para huesos, Disectores
 Periostotomi, Elevatori per ossa, Dissettori



33754-17 33755-17

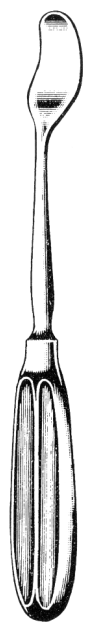
33756-17

ADSON
 17 cm, 6 3/4"

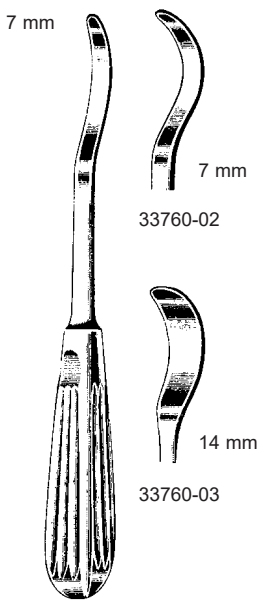


33759-06 6 mm
 33759-12 12 mm
 33759-19 19 mm
 33759-25 25 mm

KEY
 33759-06 - 33759-25
 19 cm, 7 1/2"



CHANDLER
 33763-01 19,0 cm 7 1/2"
 33763-02 20,3 cm 8"
 33763-03 22,9 cm 9"
 33763-04 25,4 cm 10"

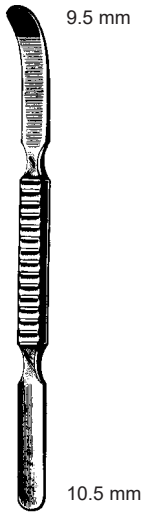


CREGO
 33760-01
 20 cm, 8"

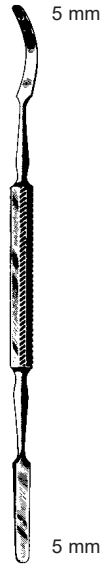


ALDERDYCE
 33761-21
 21 cm, 8 1/4"

Elevatoren, Dissektor, Knochenheber
 Elevators, Dissectors, Bone Levers
 Elevadores para huesos, Disectores
 Elevatori, Dissettori, Elevatori per ossa



WATSON-CHEYNE
 33765-17
 17,5 cm, 7"



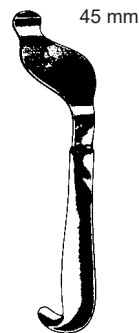
MC DONALD
 33767-19
 19 cm, 7 1/2"



MURPHY-LANE
 33769-30
 30 cm, 11 3/4"

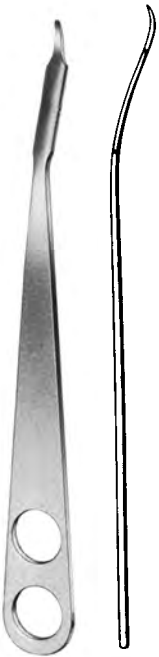


BENNETT
 33771-71
 26 cm, 10 1/4"

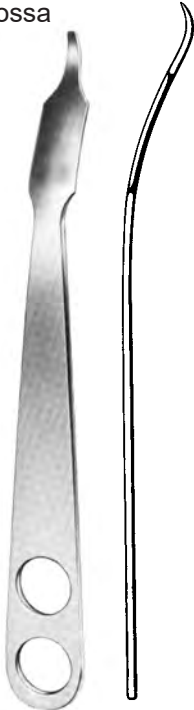


BENNETT
 33771-73
 26 cm, 10 1/4"

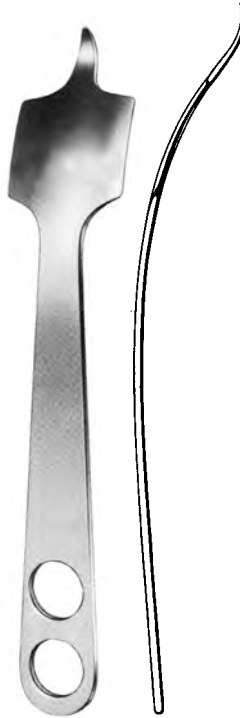
Knochenhebel
Bone Levers
Elevadores para huesos
Elevatori per ossa



HOHMANN
23,5 cm, 9 1/4"
33801-08 8 mm
33801-10 10 mm
33801-12 12 mm



HOHMANN
33801-18
18 mm, 3/4"
23,5 cm, 9 1/4"



HOHMANN
33801-43
43 mm, 1 3/4"
26 cm, 10 1/4"



HOHMANN
33801-70
70 mm, 2 3/4"
25 cm, 10"



KÖNIG
33802-01
15 cm, 6"



KÖNIG
33802-02
15 cm, 6"



33802-14
14 cm, 5 1/2"



HAYES
33803-05
15 cm, 6"

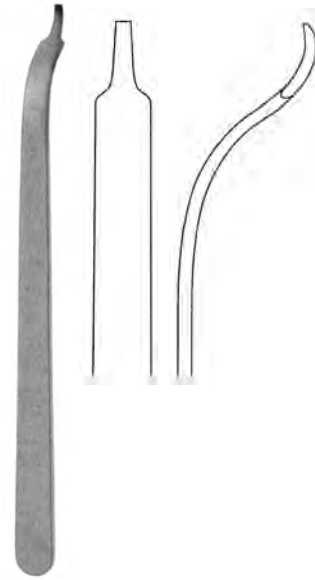


33803-07
15 cm, 6"

Knochenhebel
Bone Levers
Elevadores para huesos
Elevatori per ossa



HOHMANN
25 cm, 10"
33803-43 43 mm



BUCK-GRAMCKO
33804-15 7,5 mm



HOHMANN
25 cm, 10"
33805-22 22 mm



HOHMANN
29 cm, 11 1/2"
33805-33 33 mm

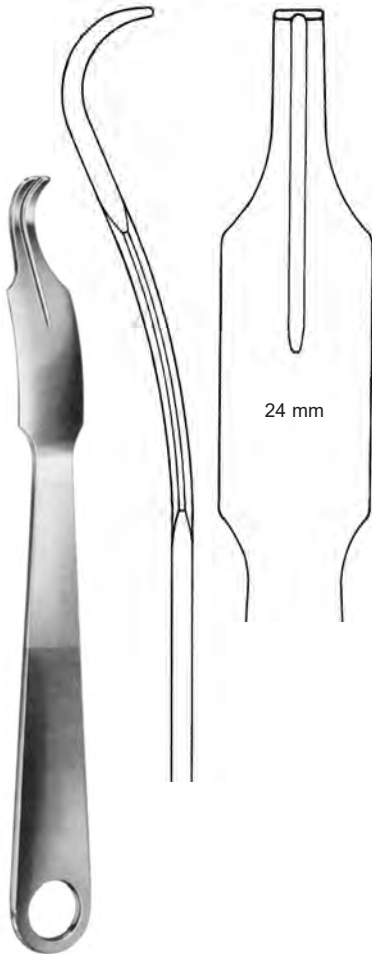


HOHMANN
27,5 cm, 10 3/4"
33807-24 24 mm

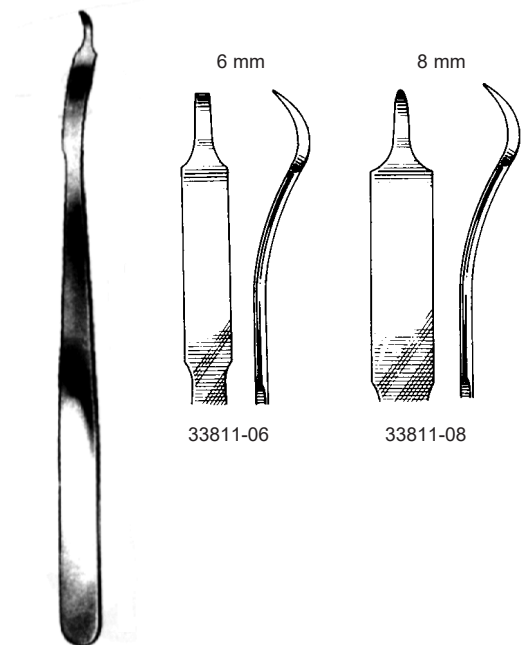


HOHMANN
25 cm, 10"
33809-22 22 mm

Knochenhebel
 Bone Levers
 Elevadores para huesos
 Elevatori per ossa

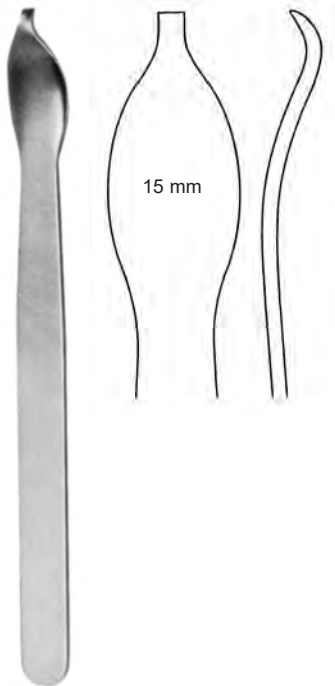


LANGE-HOHMANN
 33810-24
 25 cm, 10"

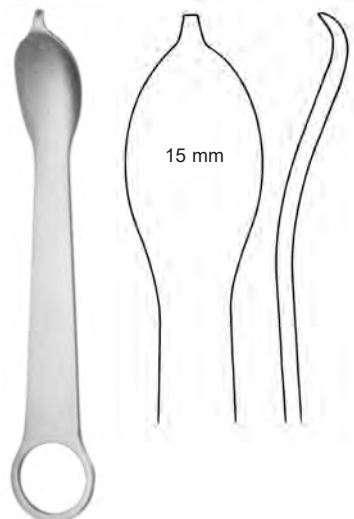


HOHMANN mini
 16 cm, 6 1/4"

Knochenhebel
Bone Levers
Elevadores para huesos
Elevatori per ossa

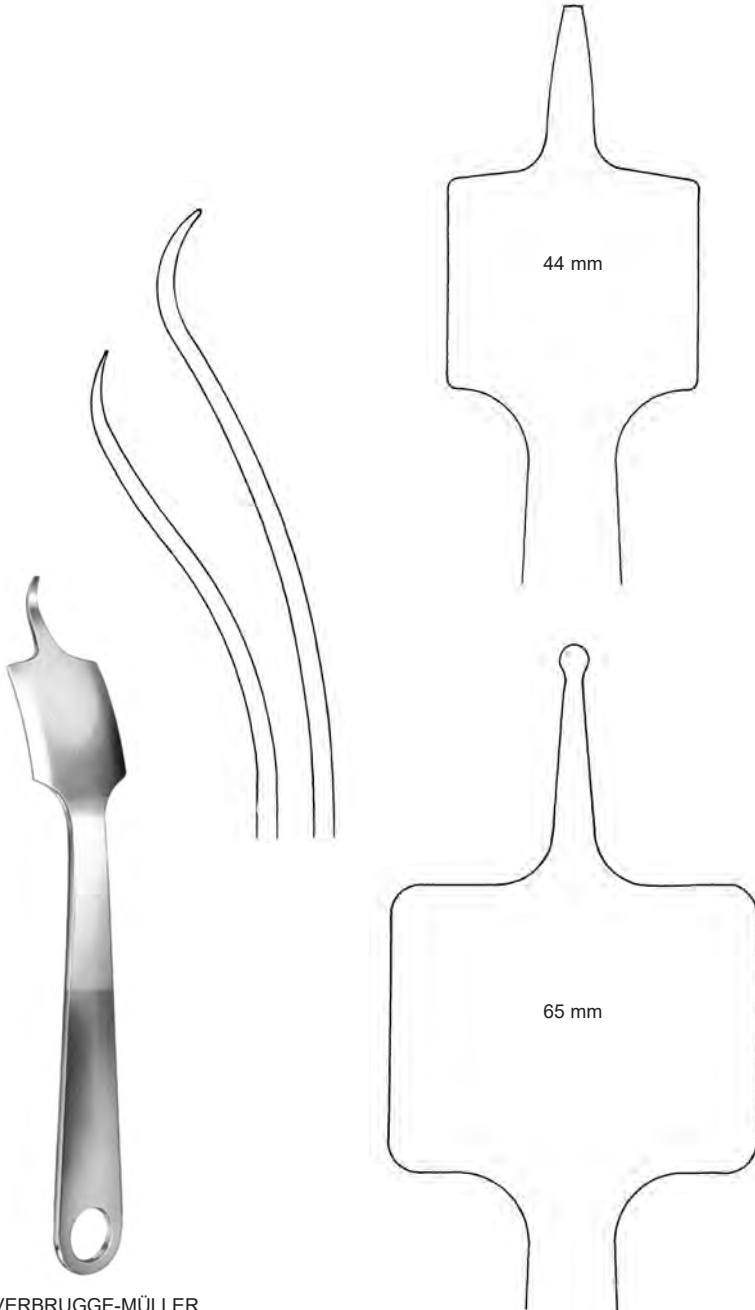


33812-16
16 cm, 6 1/4"



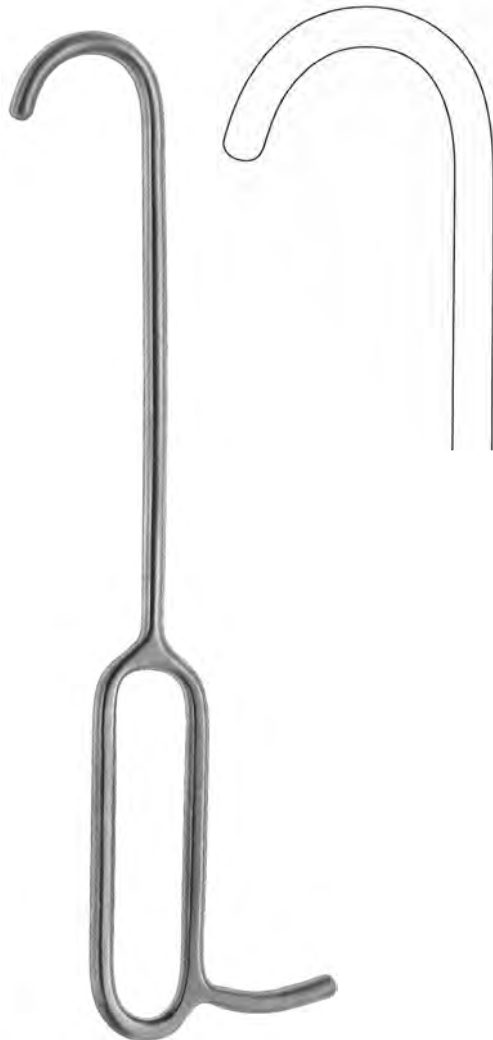
33813-12
12 cm, 4 3/4"

Knochenhebel
Bone Levers
Elevadores para huesos
Elevatori per ossa



VERBRUGGE-MÜLLER
33814-44 24,0 cm, 9 ½"
33814-65 25,5 cm, 10"

Knochenhebel
Bone Levers
Elevadores para huesos
Elevatori per ossa



LAMBOTTE
33820-27
27 cm, 10 3/4"

Knochenhebel
Bone Levers
Elevadores para huesos
Elevatori per ossa

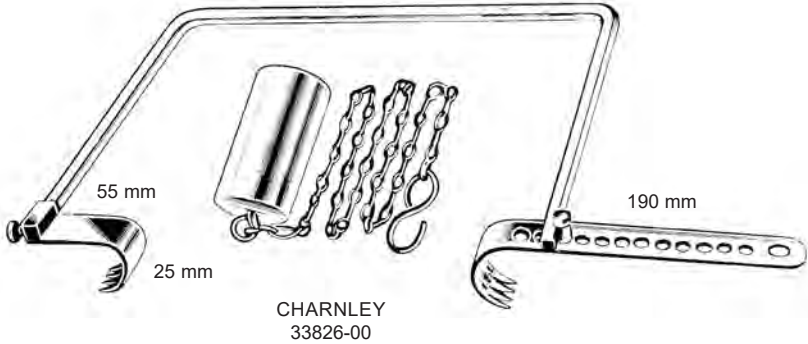


BLOUNT
33823-26
26 cm, 10 1/4"



BLOUNT
33825-26
26 cm, 10 1/4"

Retraktor, Knochenhebel, Meniskushaken
 Retractor, Bone Levers, Meniscus Retractors
 Separador, Elevadores p. huesos, Separadores para menisco
 Divaricatori, Elevatori per ossa, Divaricatori per il menisco



33826-01 spitz, gerieft
 pointed tip, serrated
 punta aguda, dentada
 punta acuta, zigrinata

33826-02 stumpf, gerieft
 blunt tip, serrated
 punta roma, dentada
 punta smussa, zigrinata

33826-03 stumpf, glatt
 blunt tip, smooth
 punta roma, lisa
 punta smussa, liscia



AUFRANC-COBRA
26 cm, 10 1/4"



BLOUNT
33827-17
17,5 cm, 7"

Knochenhebel
Bone Levers
Elevadores p. huesos
Elevatori per ossa



LANE TRETOWAN
33828-21
21,5 cm, 8 ½"



LANE
33829-25
25,5 cm, 10"



BRISTOW
33830-23
23 cm, 9"

Knochenheber, Meniskushaken
 Bone Levers, Meniscus Retractors
 Elevadores p. huesos, Separadores para menisco
 Elevatori per ossa, Divaricatori per il menisco



TAYLOR
 16,5 cm, 6 1/2"
 33831-16 75x30 mm
 33833-16 100x30 mm



SMILLIE
 14 cm, 5 1/2"
 12 x 13 mm
 33832-01



SMILLIE
 14 cm, 5 1/2"
 52 x 13 mm
 33832-02



SMILLIE
 14 cm, 5 1/2"

32 x 19 mm
 33832-03

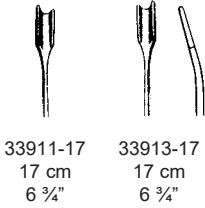
48 x 19 mm
 33832-04

57 x 19 mm
 33832-05

Sehnenschäler, Sehnenfaßpinzette, Sehnenhaltezange, Sehnenfaßinstrumente
 Tendon seizing instruments
 Instrumentos para coger tendones
 Enucleatore di tendine, Strumenti per afferrare tendini

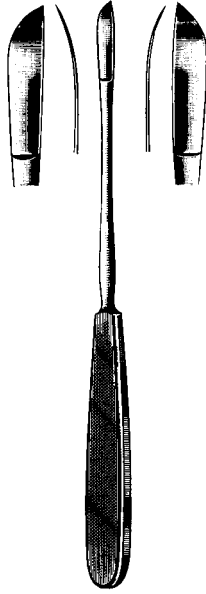


SMILLIE
 33910-17
 17 cm, 6 3/4"



33911-17
 17 cm
 6 3/4"

33913-17
 17 cm
 6 3/4"



NEFF
 33921-22 - 33923-22
 22 cm, 8 3/4"

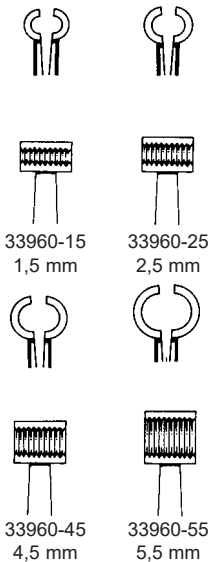


	33950-01	3 mm
	33950-02	4 mm
	33950-03	5 mm
	33950-04	6 mm
	33950-05	7 mm

BUNELL
 33950-01 - 33950-05
 15 cm, 6"



LARSEN
 33960-15 - 33960-55
 10 cm, 4"



33960-15
 1,5 mm

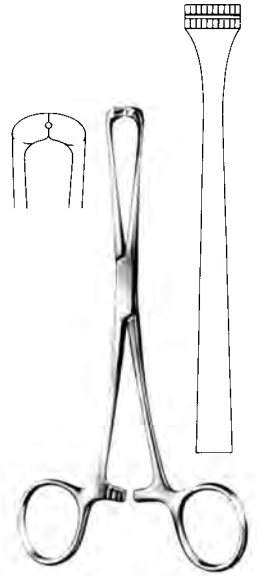
33960-25
 2,5 mm

33960-45
 4,5 mm

33960-55
 5,5 mm



JACKSON
 33961-15
 15 cm, 6"



STEINMANN
 33962-16
 16 cm, 6 1/4"

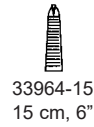
Sehnenfaßinstrumente, Sehnenführer
 Tendon seizing instruments, Tendon passing instr.
 Instrumentos para coger tendones, Instrumento p. el tunel del tendon
 Strumenti per afferrare tendini



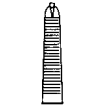
33963-12
 12 cm, 4 3/4"



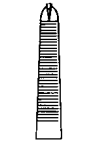
BRAND
 33964-15 - 33964-24



33964-15
 15 cm, 6"



33964-19
 19 cm, 7 1/2"



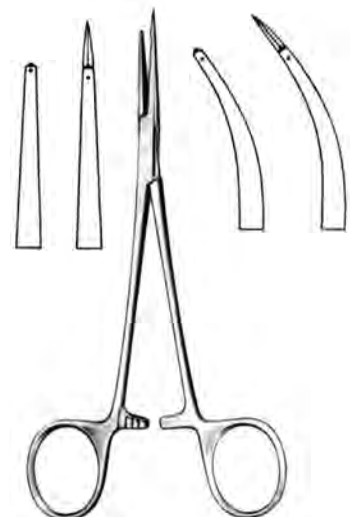
33964-24
 24 cm, 9 1/2"



BRAND
 33965-15 15 cm, 6"
 33965-19 19 cm, 7 1/2"
 33965-24 24 cm, 9 1/2"

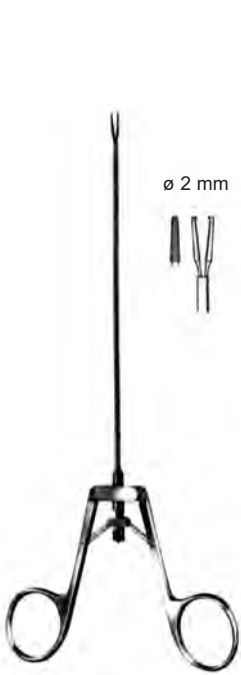


CAROLL
 33966-11
 11 cm, 4 3/8"



33966-15 15 cm, 6" 33967-15

Sehnenfassinstrumente, Sehnenstripper, Knochenfeilen, Raspeln
 Tendon seizing instruments, Tendon Strippers, Bone Files, Rasps
 Instrumentos para coger tendones, Enucleadores de tendones, Limas, Escofinas
 Strumenti per afferrare tendini, Scollatendini, Lime per ossa, Raspe



KLEINERT-KUTZ
 33967-20
 20 cm, 8"



ø 3 mm
 33968-30
 30 cm, 11 ¼"



ø 6 mm
 33968-60
 50 cm, 19 ½"

BRAND



biegsam
 malleable
 malleable
 malleabile

BUNELL

33969-18 18 cm, 7"
 33969-23 23 cm, 9"



biegsamer Schaft
 flexible shaft
 vastago maleable
 camicia flessibile

BUNELL 23 cm

33970-01 ø 4,0 mm
 33970-02 ø 4,5 mm
 33970-03 ø 5,5 mm



33971-24
 24,5 cm, 9 ¾"



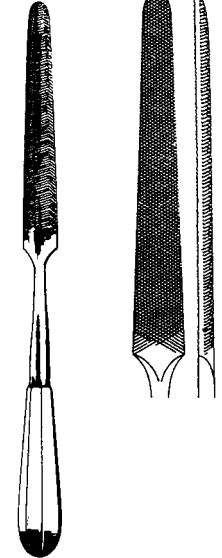
33972-22
 22 cm, 8 ¾"



PUTTI
 33973-27
 27 cm, 10 ½"



PUTTI
 33975-30
 30 cm, 11 ¼"



33977-28
 28 cm, 11"

Komprimeter
Pneumatic Tourniquet
Torniquete pneumático
Apparecchio di compressione



34101-01
compl.

Gerät zur Erzeugung von Blutleere in den Gliedmaßen
Compression Apparatus for producing blood vacuum in limbs
Aparato de compresión para producir el vacío de sangre en los miembros
Vacumentro per determinare vuoti di sangue nelle membra

34101-02	34101-03	34101-04	34101-05	34101-08
Pumpe	Manometer	Oberarmmanschette	Oberschenkelmanschette	Armmanschette Kinder
Air Pump	Manometer	Cuff for upper arm	Cuff (leg)	Cuff for children
Bomba de aire	Manómetro	Brazalete (brazo)	Brazalete (pierna)	Brazalete para niños
Pompa di aria	Manometro	Bracciale	Cosciale	Polsino per i bambini
		34101-06 incl.	34101-07 incl.	

34101-06
Polster für Oberarmmanschette 46 x 6 cm (18" x 2.4")
Bandage cuff for arm 46 x 6 cm (18" x 2.4")
Colchon para brazalete para brazo 46 x 6 cm (18" x 2.4")
Bracciale per braccio superiore 46 x 6 cm (18" x 2.4")

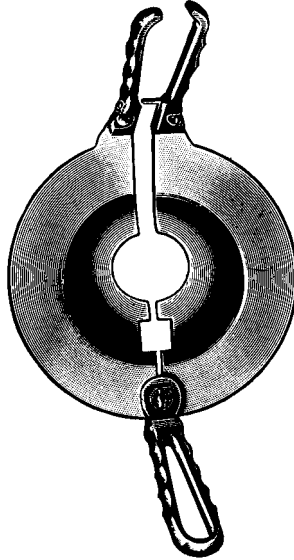
34101-07
Polster für Oberschenkelmanschette 55 x 10 cm (21 ½ x 10")
Bandage cuff for leg 55 x 10 cm (21 ½ x 10")
Colchon para brazalete para el femur 55 x 10 cm (21 ½ x 10")
Bracciale per coscia superiore 55 x 10 cm (21 ½ x 10")

Amputations- und Resektionssägen
 Amputation and Resection Saws
 Sierras para amputación y resección
 Seghe per amputazione e resezione

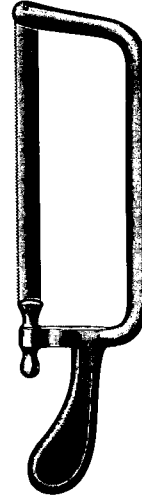
Staubinde
 Compression bandage
 Vendaje de compresión
 Benda per compressione
 5 m lang / long
 6 cm breit / wide



ESMARCH
 34105-01



PERCY
 34110-00



CHARRIERE
 34112-00
 35 cm, 13 3/4"

34112-01
 12 mm

Ersatzsägeblätter
 Spare saw blades
 Hojas de sierra de repuesto
 Lame di ricambio

34112-02
 15 mm

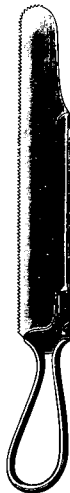
Ersatzsägeblätter
 Spare saw blades
 Hojas de sierra de repuesto
 Lame di ricambio

komplett mit 2 Blättern
 complete with 2 blades
 completo con 2 hojas
 completa con 2 lame

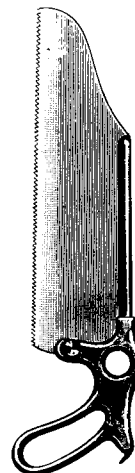


mit 3 Sägeblätter
 4 - 6 - 8 mm
 with 3 spare blade
 con 3 hojas de repuesto
 con 3 lame di ricambio

BIER
 34114-39
 40,5 cm, 16"



CHARRIERE
 34116-30
 30 cm, 11 3/4"



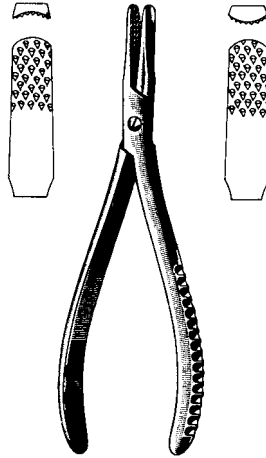
SATTERLEE
 34118-31
 31 cm, 12 1/4"

34118-99
 Sägeblatt
 blade
 hoja
 lama



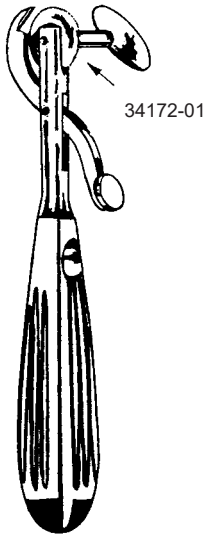
LANGENBECK
 34120-23
 23 cm, 9"

Nagelausreißzange, Fingerringsägen
 Fcps. f. tearing out finger nails, Finger Ring Saws
 Pinzas para arrancar uñas, Sierras para abrir anillos
 Pinze per lacerazione delle unghie, Seghe per anelli



RADOLF

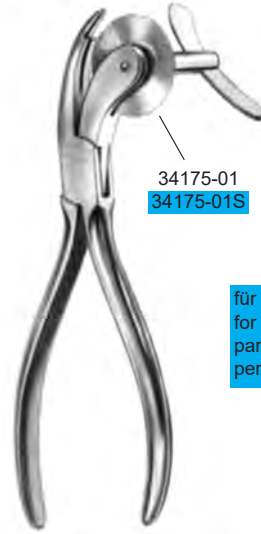
34161-13 13,5 cm, 5 1/4" 3 mm
 34162-13 13,5 cm, 5 1/4" 6 mm



WALTON
 34172-00
 16 cm, 6 1/4"

Sägeblatt
 Saw blade
 Hoja de sierra
 Lama di ricambio

34172-01



REDA
 34175-00
 34175-00S
 17 cm, 6 3/4"

Sägeblatt
 Saw blade
 Hoja de sierra
 Lama di ricambio

34175-01
 34175-01S

für Titanfingerringe
 for titanium rings
 para anillos de titanio
 per anelli di titanio

Bohrapparate, Bohrlochzange
 Bone Hand Drills, Forceps for Bone Hole
 Perforador de mano, Pinza de guía
 Perforatori a mano, Pinza per perforazione



34241-00
 Griff allein
 Handle only
 Mango solo
 Manico solo

HUDSON
 34240-27 27 cm, 10 1/4"
 compl. incl. 34242-09, -14, -16, -22,
 34246-00



34242-09
 9 mm



34242-14
 14 mm



34242-16
 16 mm



34242-22
 22 mm



ø 2 mm
 34243-02



CUSHING
 34244-10
 34244-14
 34244-16



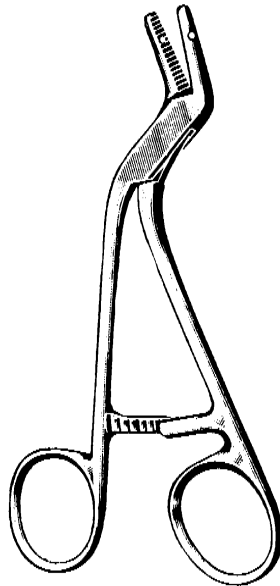
ERRICO
 34244-17
 ø 16 mm



MC KENZIE
 34248-00
 ø 13 mm



34246-00
 Verlängerungsstück
 Extension piece
 Pieza alargadera
 Giunto di prolungamento



ADSON
 34231-15
 15 cm, 6"

Bohrapparate
Bone Hand Drills
Perforador de mano
Perforatori a mano



RALK
34280-00

Bohrapparat mit Leichtmetallgehäuse, mit Dreibackenspannfutter und Schlüssel, Spannweite bis D. 6,35 mm
Hand drill with light metal case, with three-jaw-chuck and key, opening up to D. 6,35 mm

Perforador manual con caja de aluminio, con mandrilo de tres mordazas y llave, abriendo hasta 6,35 mm de D.

Perforatore a mano con cassa in metallo leggero, con mandrino a tre ganasce e chiave, apertura fino a 6,35 mm di D.



REDA
34290-00

Handbohrapparat mit umstellbarem Handgriff, mit Jacobs Dreibackenspannfutter und Schlüssel
Hand drill with adjustable handle, with Jacobs three-jaw-chuck and wrench

Perforador de mano en T con cierre Jacobs de 3 mordazas y llave de ajuste

Perforatore a mano con manico regolabile, con mandrino a tre ganasce di Jacobs e chiave



34270-01
Schlüssel
Wrench
Llave
Chiave

BUNELL
34270-00 16 cm, 6 1/4"

Bohrapparat 16 cm (6 1/4"), längsdurchbohrt mit Dreibackenspannfutter und Schlüssel, Spannweite bis 4 mm
Hand drill, 16 cm (6 1/4"), longitudinally bored, with three-jaw-chuck and key, opening up to 4 mm

Perforador manual, 16 cm (6 1/4"), taladrado longitudinalmente, con mandrilo de tres mordazas y llave, abriendo hasta 4 mm

Perforatore a mano, 16 cm (6 1/4"), con perforazione assiale, con mandrino a tre ganasce e chiave, apertura fino a 4 mm di D.

Handgriffe
Handles
Manejar
Maniglie



34295-00

Spannschlüssel allein
Key only
Llave suelta
Chiave solo



34296-00

Handgriff mit Jacobs-spann-
futter und Spannschlüssel
bis 3,6 mm
Handle with Jacobs chuck
and key to 3,6 mm
Mango con cierre Jacobs,
de 3 mordazas y llave a
3,6 mm
Manico con mandrino di
Jacobs e chiave a 3,6 mm



34296-05

T-Handgriff, verriegelbares schlüsselloses
Dreibacken-spannfutter, rostfrei
T-handle, keyless locking chuck
Mango en T, mordaza sin llave, inox.
Chiave a T con mandrino a tre ganasce inox



34296-10

Handgriff, Dreibacken-spannfutter, inkl.
Spannschlüssel rostfrei
Handle with chuck, including key
Mango, mordaza incluyendo llave, inox.
Mandrino a tre ganasce con manico retto
completo di chiave di arresto inox

Schnellkupplungs-Handgriffe
 Handles with quick-action chuck
 Mangos de acople rápido
 Manici con attachi rapidi



34296-25
 Schnellkupplungs-T-Handgriff
 T-Handle, quick-action
 Mango en T, acople rápido
 Mandrino a T con raccordo rapido



34296-35
 Schnellkupplungs-Handgriff
 mit Hartgewebegriff
 Handle, quick-action,
 made of very hard fibre
 Mango de acople rápido,
 de material extra-duro
 Mandrino medio rapido con
 manico a fibre dure



34296-40
 Mini Schnellkupplungs-Handgriff
 für „Dental“-Anschluß
 Mini-Handle, quick-action,
 "dental"
 Mini-Mango de acople rápido
 "dental"
 Mini mandrino-rapido con
 impugnatura cilindrica con
 attacco dentale

Bohrer
Drill bits
Taladros
Perforatore



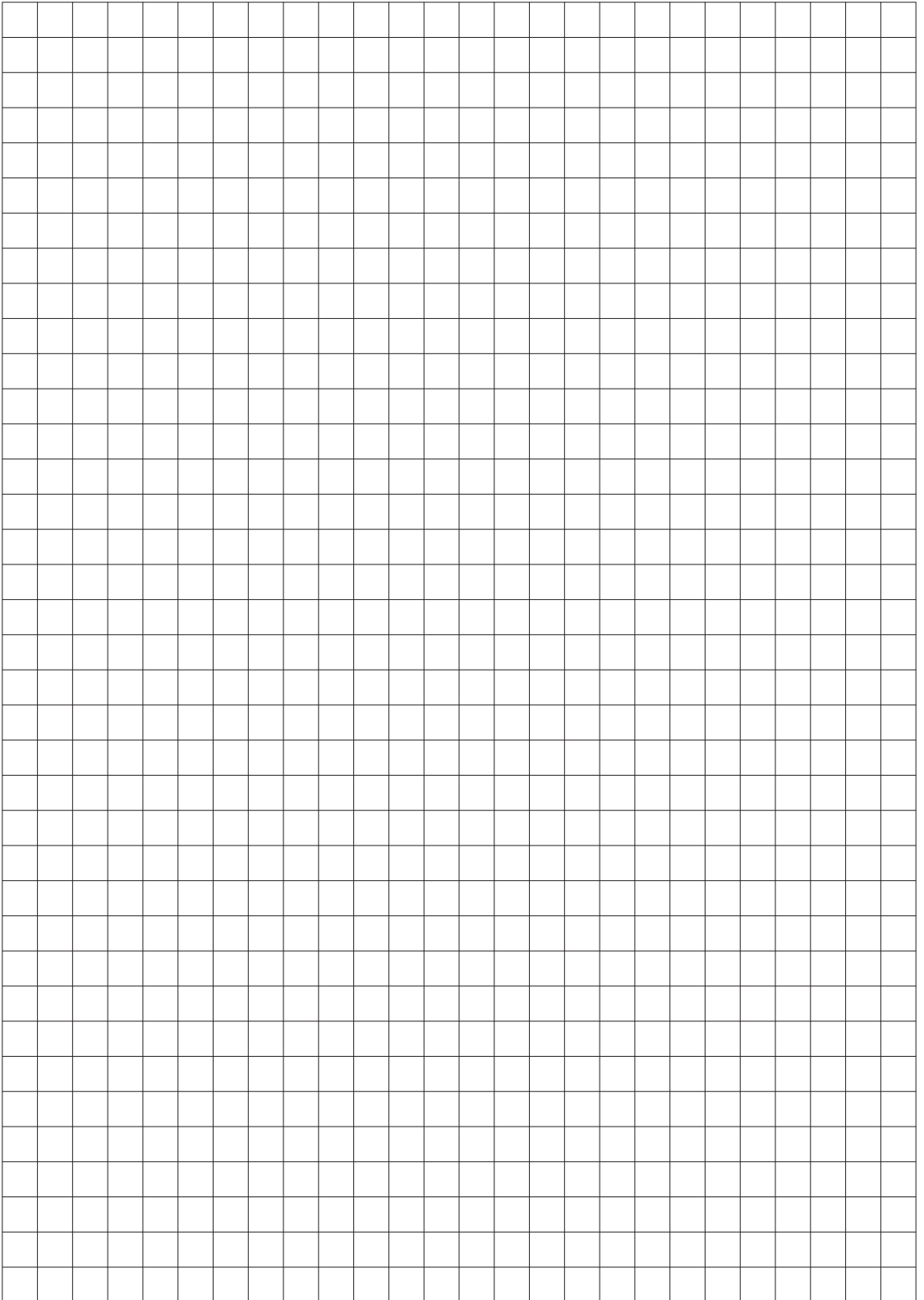
Ø		
1,0 mm	56 mm	34320-10
1,5 mm	70 mm	34320-15
2,0 mm	85 mm	34320-20
2,5 mm	95 mm	34320-25
2,7 mm	100 mm	34320-27
3,0 mm	100 mm	34320-30
3,2 mm	106 mm	34320-32
3,5 mm	112 mm	34320-35
4,0 mm	119 mm	34320-40
4,5 mm	126 mm	34320-45
5,0 mm	132 mm	34320-50
6,0 mm	139 mm	34320-60
7,0 mm	156 mm	34320-70

Spiralbohrer mit Glattschaft
Twist Drills with round end
Taladros espirales con vástago redondo
Perforatore elicoidale

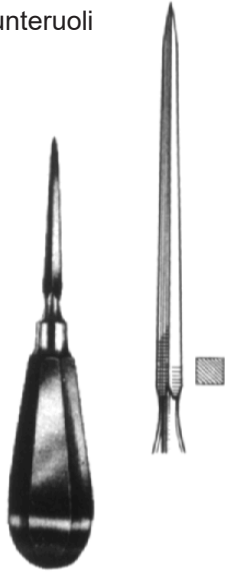


Ø		
1,1 mm	60 mm	34322-11
1,5 mm	85 mm	34322-15
2,0 mm	100 mm	34322-20
2,5 mm	110 mm	34322-25
2,7 mm	100 mm	34322-27
3,2 mm	145 mm	34322-32
3,5 mm	110 mm	34322-35
4,5 mm	145 mm	34322-45

Spiralbohrer mit Schnellkupplungs-Ansatz
Twist Drills, quick-action
Taladros espirales, acople rápido
Perforatore elicoidale con attacco rapido



Pfrieme, Reibahle
Awl, Reamer
Escariadores
Lesine, Punteruoli



34392-14
14 cm, 5 ½"

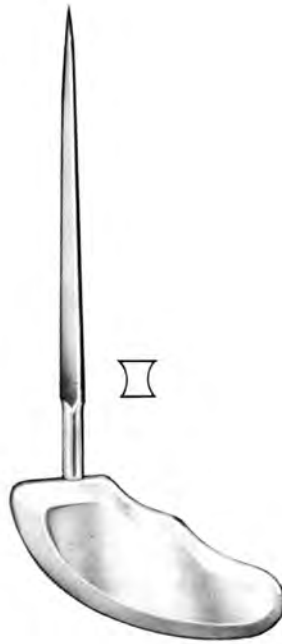


OMBREDANNE
18 cm, 7"

34395-03	3 mm
34395-05	5 mm
34395-06	6 mm
34395-08	8 mm



PERTHES
34393-18
18 cm, 7"

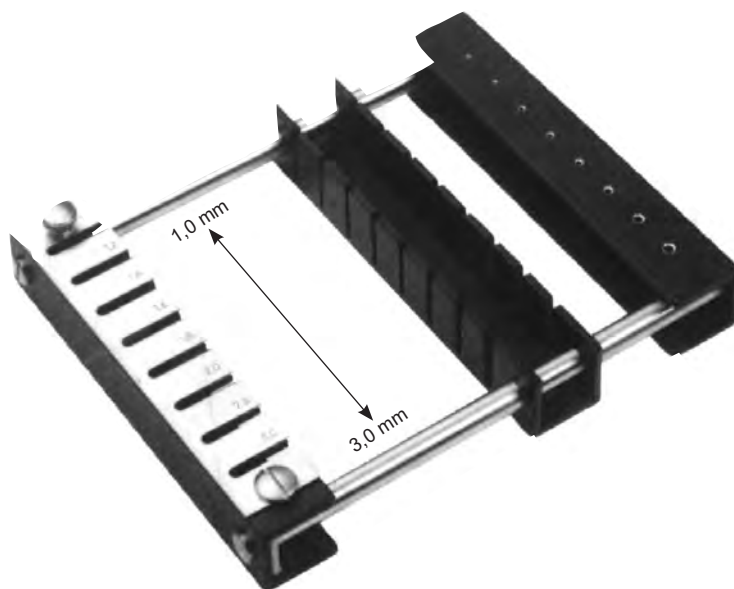


PERTHES
34393-21
21 cm, 8 ¼"



34394-14
14 cm, 5 ½"

Bohrdrahtspender
Support for sterilisation
Soporte de esterilización
Supporto per la sterilizzazione



Bohrdrahtspender für Kirschner-Drähte
Support for sterilisation of Kirschner wires
Soporte de esterilización p. alambres de Kirschner
Supporto per la sterilizzazione dei fili di Kirschner

34440-01 bis 15 cm – up to 15 cm (6") – hasta 15 cm – fino a 15 cm
34440-02 bis 31 cm – up to 31 cm (12 1/4") – hasta 31 cm – fino a 31 cm
34440-03 bis 10 cm – up to 10 cm (4") – hasta 10 cm – fino a 10 cm


Bohrdrähte
Drill Wires
Alambres
Perforatori filiformi

lieferbar in Packungen à 10 Stück
 available in packages of 10 pieces
 disponible en paquets de 10 unidades
 disponibili solo in confezioni da 10 pezzi


Trokarspitze / Trocar point
 Punta trocar / Punte trequarti

Trokarspitze / Trocar point
 Punta trocar / Punte trequarti

Mindestbestellmenge 30 Stück
 minimum order quantity 30 pieces
 cantidad mínima de pedido 30 piezas
 quantità di ordine minimo 30 pezzi



Ø	10 cm, 4"	15 cm, 6"	31 cm, 12 1/4"
0,8	34401-08	34402-08	34403-08
1,0	34401-10	34402-10	34403-10
1,1	34401-11	34402-11	34403-11
1,2	34401-12	34402-12	34403-12
1,3	34401-13	34402-13	34403-13
1,4	34401-14	34402-14	34403-14
1,5	34401-15	34402-15	34403-15
1,6	34401-16	34402-16	34403-16
1,7	34401-17	34402-17	34403-17
1,8	34401-18	34402-18	34403-18
1,9	34401-19	34402-19	34403-19
2,0	34401-20	34402-20	34403-20
2,2	34401-22	34402-22	34403-22
2,3	34401-23	34402-23	34403-23
2,4	34401-24	34402-24	34403-24
2,5	34401-25	34402-25	34403-25
2,8	34401-28	34402-28	34403-28
3,0	34401-30	34402-30	34403-30




Ø	10 cm, 4"	15 cm, 6"	31 cm, 12 1/4"
0,8	34404-08	34405-08	34406-08
0,9	34404-09	34405-09	34406-09
1,0	34404-10	34405-10	34406-10
1,1	34404-11	34405-11	34406-11
1,2	34404-12	34405-12	34406-12
1,3	34404-13	34405-13	34406-13
1,4	34404-14	34405-14	34406-14
1,5	34404-15	34405-15	34406-15
1,6	34404-16	34405-16	34406-16
1,7	34404-17	34405-17	34406-17
1,8	34404-18	34405-18	34406-18
1,9	34404-19	34405-19	34406-19
2,0	34404-20	34405-20	34406-20
2,2	34404-22	34405-22	34406-22
2,3	34404-23	34405-23	34406-23
2,4	34404-24	34405-24	34406-24
2,5	34404-25	34405-25	34406-25
2,8	34404-28	34405-28	34406-28
3,0	34404-30	34405-30	34406-30

Kirschner
 mit rundem Ende / with round shaft
 con extremo redondo / con estremo rotondo

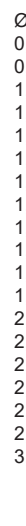
Kirschner
 mit flachem Ende / with flat shaft
 con extremo plano / con estremo piatto

Trokarspitze / Trocar point
 Punta trocar / Punte trequarti

Lanzenspitze / Lance point
 Punta lanceolar / Punte lanceolata



Ø	10 cm, 4"	15 cm, 6"	31 cm, 12 1/4"
0,8	34407-08	34408-08	34409-08
0,9	34407-09	34408-09	34409-09
1,0	34407-10	34408-10	34409-10
1,1	34407-11	34408-11	34409-11
1,2	34407-12	34408-12	34409-12
1,3	34407-13	34408-13	34409-13
1,4	34407-14	34408-14	34409-14
1,5	34407-15	34408-15	34409-15
1,6	34407-16	34408-16	34409-16
1,7	34407-17	34408-17	34409-17
1,8	34407-18	34408-18	34409-18
1,9	34407-19	34408-19	34409-19
2,0	34407-20	34408-20	34409-20
2,2	34407-22	34408-22	34409-22
2,3	34407-23	34408-23	34409-23
2,4	34407-24	34408-24	34409-24
2,5	34407-25	34408-25	34409-25
2,8	34407-28	34408-28	34409-28
3,0	34407-30	34408-30	34409-30



Ø	31 cm, 12 1/4"
0,8	34410-08
0,9	34410-09
1,0	34410-10
1,1	34410-11
1,2	34410-12
1,3	34410-13
1,4	34410-14
1,5	34410-15
1,6	34410-16
1,7	34410-17
1,8	34410-18
1,9	34410-19
2,0	34410-20
2,2	34410-22
2,3	34410-23
2,4	34410-24
2,5	34410-25
2,8	34410-28
3,0	34410-30

Kirschner
 Trokarende / Trocar shaft
 Punta trocar / Punte trequarti Bilaterali

Kirschner
 mit flachem Ende / with flat shaft
 con extremo plano / con estremo piatto

lieferbar in Packungen à 10 Stück
available in packages of 10 pieces
disponible en paquets de 10 unidades
disponibili solo in confezioni da 10 pezzi

Bohrdrähte, Knochennägel
Drill Wires, Fracture pins
Alambres, Clavos para huesos
Perforatori filiformi, Chiodi per ossa

Mindestbestellmenge 30 Stück
minimum order quantity 30 pieces
cantidad mínima de pedido 30 piezas
quantità di ordine minimo 30 pezzi

Lanzenspitze / Lance point
Punta lanceolar / Punta lanceolata

Trokarspitze / Trocar point
Punta trocar / Punta trequarti



Ø 31 cm, 12 1/4"
0,8 34411-08
0,9 34411-09
1,0 34411-10
1,1 34411-11
1,2 34411-12
1,3 34411-13
1,4 34411-14
1,5 34411-15
1,6 34411-16
1,7 34411-17
1,8 34411-18
1,9 34411-19
2,0 34411-20
2,2 34411-22
2,3 34411-23
2,4 34411-24
2,5 34411-25
2,8 34411-28
3,0 34411-30



	Ø	Ø	Ø	Ø	Ø
	3,5 mm	4,0 mm	4,5 mm	5,0 mm	6,0 mm
8 cm, 3 1/8"	34412-08	34413-08	34415-08	34417-08	34419-08
10 cm, 4"	34412-10	34413-10	34415-10	34417-10	34419-10
12 cm, 4 3/4"	34412-12	34413-12	34415-12	34417-12	34419-12
14 cm, 5 1/2"	34412-14	34413-14	34415-14	34417-14	34419-14
16 cm, 6 1/4"	34412-16	34413-16	34415-16	34417-16	34419-16
18 cm, 7"	34412-18	34413-18	34415-18	34417-18	34419-18
20 cm, 8"	34412-20	34413-20	34415-20	34417-20	34419-20
22 cm, 8 3/4"	34412-22	34413-22	34415-22	34417-22	34419-22
23 cm, 9"	34412-23	34413-23	34415-23	34417-23	34419-23
24 cm, 9 1/2"	34412-24	34413-24	34415-24	34417-24	34419-24
26 cm, 10 1/4"	34412-26	34413-26	34415-26	34417-26	34419-26
28 cm, 11"	34412-28	34413-28	34415-28	34417-28	34419-28
30 cm, 11 3/4"	34412-30	34413-30	34415-30	34417-30	34419-30

Kirschner
mit rundem Ende / with round shaft
con extremo redondo / con extremo rotondo

Steinmann
mit rundem Ende / with round shaft
con extremo redondo / con extremo rotondo

Trokarspitze / Trocar point
Punta trocar / Punta trequarti



	Ø	Ø	Ø	Ø	Ø
	3,5 mm	4,0 mm	4,5 mm	5,0 mm	6,0 mm
8 cm, 3 1/8"	34420-08	34421-08	34423-08	34425-08	34427-08
10 cm, 4"	34420-10	34421-10	34423-10	34425-10	34427-10
12 cm, 4 3/4"	34420-12	34421-12	34423-12	34425-12	34427-12
14 cm, 5 1/2"	34420-14	34421-14	34423-14	34425-14	34427-14
16 cm, 6 1/4"	34420-16	34421-16	34423-16	34425-16	34427-16
18 cm, 7"	34420-18	34421-18	34423-18	34425-18	34427-18
20 cm, 8"	34420-20	34421-20	34423-20	34425-20	34427-20
22 cm, 8 3/4"	34420-22	34421-22	34423-22	34425-22	34427-22
23 cm, 9"	34420-23	34421-23	34423-23	34425-23	34427-23
24 cm, 9 1/2"	34420-24	34421-24	34423-24	34425-24	34427-24
26 cm, 10 1/4"	34420-26	34421-26	34423-26	34425-26	34427-26
28 cm, 11"	34420-28	34421-28	34423-28	34425-28	34427-28
30 cm, 11 3/4"	34420-30	34421-30	34423-30	34425-30	34427-30


Steinmann
Trokarende / Trocar shaft
Punta trocar / Punta trequarti Bilateralis

Knochennägel
Fracture pins
Clavos para huesos
Chiodi per ossa

lieferbar in Packungen à 10 Stück
available in packages of 10 pieces
disponible en paquets de 10 unidades
disponibili solo in confezioni da 10 pezzi

Mindestbestellmenge 30 Stück
minimum order quantity 30 pieces
cantidad mínima de pedido 30 piezas
quantità di ordine minimo 30 pezzi


Trokarspitze / Trocar point
Punta trocar / Punta trequarti



	Ø	Ø	Ø	Ø	Ø
	3,5 mm	4,0 mm	4,5 mm	5,0 mm	6,0 mm
8 cm, 3 1/8"	34428-08	34429-08	34431-08	34433-08	34435-08
10 cm, 4"	34428-10	34429-10	34431-10	34433-10	34435-10
12 cm, 4 3/4"	34428-12	34429-12	34431-12	34433-12	34435-12
14 cm, 5 1/2"	34428-14	34429-14	34431-14	34433-14	34435-14
16 cm, 6 1/4"	34428-16	34429-16	34431-16	34433-16	34435-16
18 cm, 7"	34428-18	34429-18	34431-18	34433-18	34435-18
20 cm, 8"	34428-20	34429-20	34431-20	34433-20	34435-20
22 cm, 8 3/4"	34428-22	34429-22	34431-22	34433-22	34435-22
23 cm, 9"	34428-23	34429-23	34431-23	34433-23	34435-23
24 cm, 9 1/2"	34428-24	34429-24	34431-24	34433-24	34435-24
26 cm, 10 1/4"	34428-26	34429-26	34431-26	34433-26	34435-26
28 cm, 11"	34428-28	34429-28	34431-28	34433-28	34435-28
30 cm, 11 3/4"	34428-30	34429-30	34431-30	34433-30	34435-30

Steinmann
mit 3-kant-Ende / with triangular end
con extremo triangular / con extremo triangolare

Trokarspitze / Trocar point
Punta trocar / Punta trequarti



	Ø	15 cm, 6"	18 cm, 7"	20 cm, 8"	23 cm, 9"	25 cm, 10"	31 cm, 12 1/4"
mit Gewinde threaded Wires con rosca con filetto	1,6	34436-16	34437-16	34438-16	34439-16	34440-16	34441-16
	1,8	34436-18	34437-18	34438-18	34439-18	34440-18	34441-18
	2,0	34436-20	34437-20	34438-20	34439-20	34440-20	34441-20
	2,5	34436-25	34437-25	34438-25	34439-25	34440-25	34441-25
	2,8	34436-28	34437-28	34438-28	34439-28	34440-28	34441-28
	3,0	34436-30	34437-30	34438-30	34439-30	34440-30	34441-30

mit rundem Ende / with round shaft
con extremo redondo / con extremo rotondo

lieferbar in Packungen à 10 Stück
available in packages of 10 pieces
disponible en paquets de 10 unidades
disponibili solo in confezioni da 10 pezzi

Knochennägel
Fracture pins
Clavos para huesos
Chiodi per ossa

Mindestbestellmenge 30 Stück
minimum order quantity 30 pieces
cantidad mínima de pedido 30 piezas
quantità di ordine minimo 30 pezzi

Trokarspitze / Trocar point
Punta trocar / Punta trequarti

mit Gewinde
threaded Wires
con rosca
con filetto



Ø	15 cm, 6"	18 cm, 7"	20 cm, 8"	23 cm, 9"	25 cm, 10"	31 cm, 12 ¼"
1,6	34442-16	34443-16	34444-16	34445-16	34446-16	34447-16
1,8	34442-18	34443-18	34444-18	34445-18	34446-18	34447-18
2,0	34442-20	34443-20	34444-20	34445-20	34446-20	34447-20
2,5	34442-25	34443-25	34444-25	34445-25	34446-25	34447-25
2,8	34442-28	34443-28	34444-28	34445-28	34446-28	34447-28
3,0	34442-30	34443-30	34444-30	34445-30	34446-30	34447-30

Trokarende / Trocar shaft
Punta trocar / Punta trequarti

Bohrdrahtspender
K-Wire Dispenser
Dispensador para brocas filiformes
Distributore per fili

12 cm, 4 ¾"



34450-08 0,8 mm
34450-10 1,0 mm
34450-12 1,2 mm
34450-14 1,4 mm
34450-15 1,5 mm
34450-16 1,6 mm
34450-18 1,8 mm
34450-20 2,0 mm
34450-22 2,2 mm
34450-25 2,5 mm
34450-30 3,0 mm

17 cm, 6 ¾"

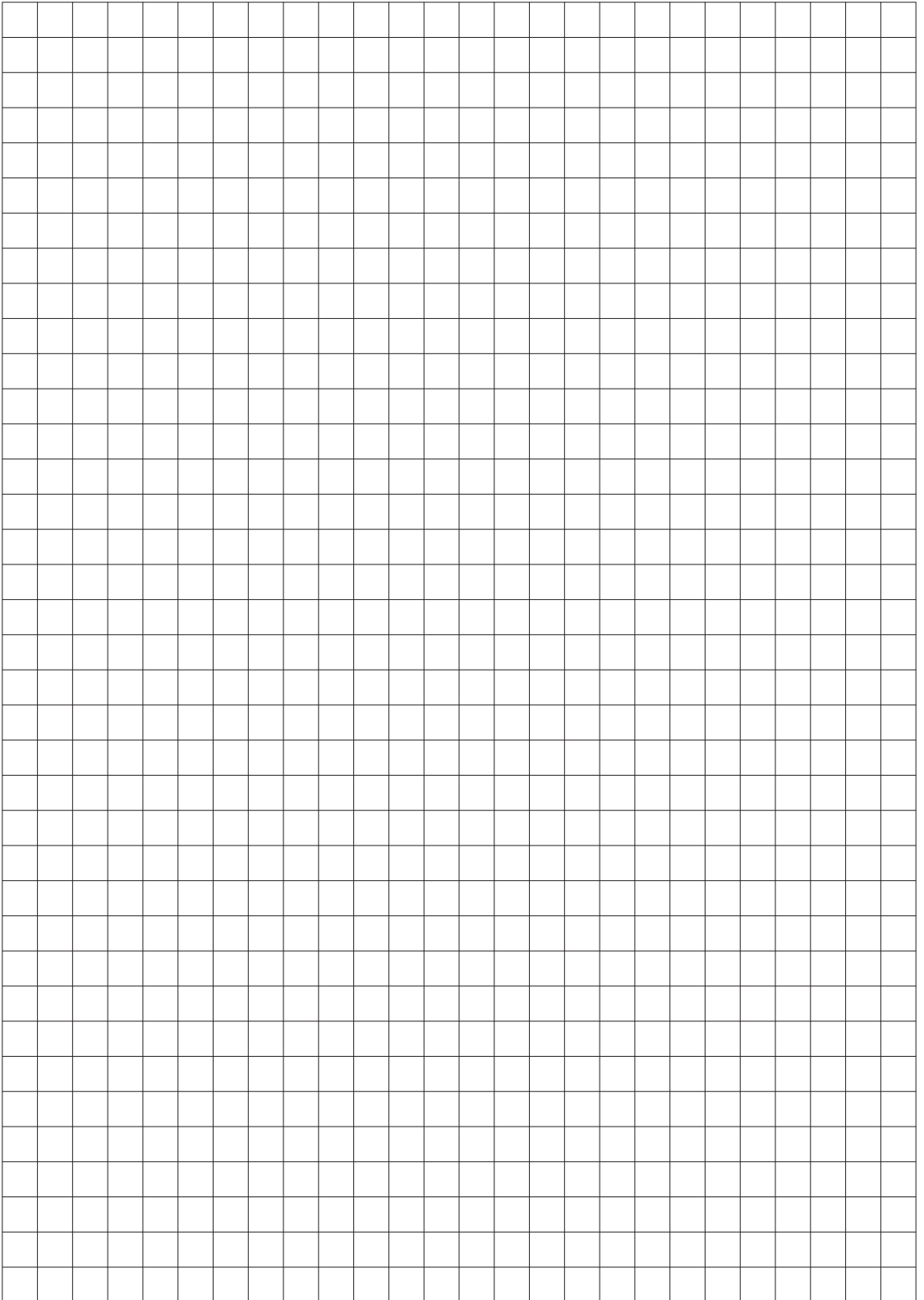


34460-08 0,8 mm
34460-10 1,0 mm
34460-12 1,2 mm
34460-14 1,4 mm
34460-15 1,5 mm
34460-16 1,6 mm
34460-20 2,0 mm
34460-22 2,2 mm
34460-25 2,5 mm
34460-30 3,0 mm

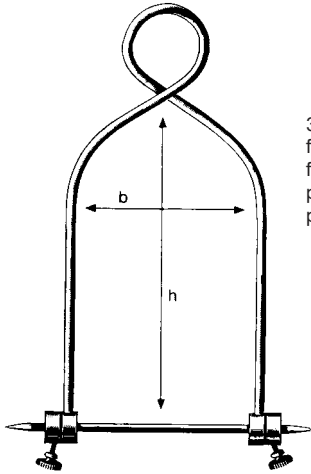
33 cm, 13"



34470-08 0,8 mm
34470-10 1,0 mm
34470-12 1,2 mm
34470-14 1,4 mm
34470-15 1,5 mm
34470-16 1,6 mm
34470-20 2,0 mm
34470-22 2,2 mm
34470-25 2,5 mm
34470-30 3,0 mm

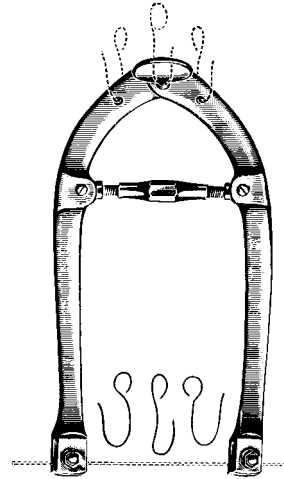


Extensionsbügel
Extension Bows
Estribos para extensión
Archi per estensione



34502-16
für Arm
for arm
para brazo
per braccio

16 x 9 cm
6 1/4" x 3 1/2"

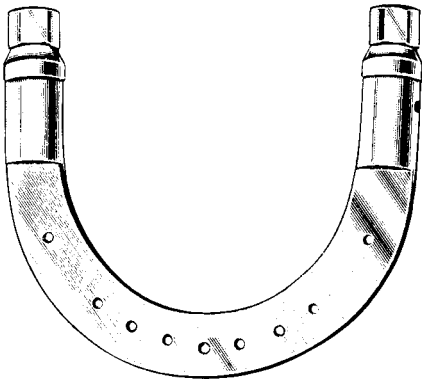


KIRSCHNER

BÖHLER
34502-15 21 x 15 cm 8 1/4" x 6"
34502-21 21 x 11 cm 8 1/4" x 4 3/8"
für Oberschenkel und Knie
for thigh and knee
para femur y rodilla
per femore e ginocchio

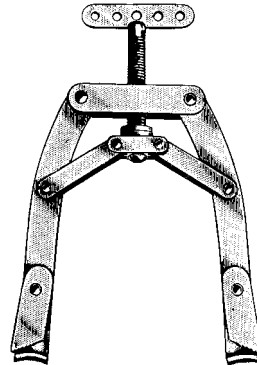
34514-18 40 - 140 mm x 115 mm mit 3 Zughaken
with 3 hooks
con 3 ganchos
con 3 ganci per trazione

34514-27 60 - 220 mm x 175 mm mit 3 Zughaken
with 3 hooks
con 3 ganchos
con 3 ganci per trazione



KIRSCHNER

34515-09 9,5 x 7,0 cm 3 3/4" x 2 3/4"
34515-10 9,5 x 11,0 cm 3 3/4" x 4 3/8"
34515-11 10,5 x 10,0 cm 4,1" x 4"
34515-12 12,0 x 12,0 cm 4 3/4" x 4 3/4"
34515-13 13,5 x 13,0 cm 5 1/4" x 5 1/8"
34515-15 15,5 x 15,5 cm 6" x 6"
34515-20 20,0 x 15,5 cm 8" x 6"



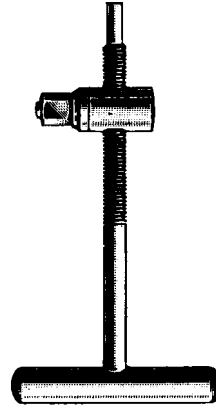
KIRSCHNER U.S.

34518-01
mittel, medium, mediano, max. 130 mm (5 1/8")
34518-02
groß, large, grande, grande, max. 185 mm (7 1/4")
34518-03
extra groß, large extra long, muy grande, max. 220 mm (8 3/4")

Spannschlüssel, Zughaken
Tightening wrench, hooks
Llave tensora, ganchos
Chiave, ganci per trazione



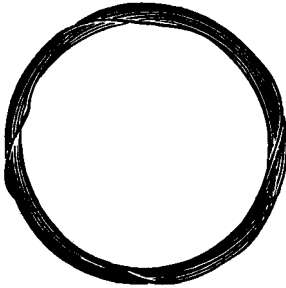
34515-01



34515-02

KIRSCHNER
34519-01KIRSCHNER
34519-02

Knochendraht
Bone wire
Hilos para huesos
Filo per ossa



weich, in Ringen zu 10 m (32,8 Feet)
soft, in coils of 10 m (32,8 Feet)
blando, de 10 m (32,8 Feet)
morbido, 10 m (32,8 Feet)

Material:
nichtrostender Implantatstahl
nach DIN 17443 (ISO 5832/1)

	mm Ø
34520-02	0,2
34520-03	0,3
34520-04	0,4
34520-05	0,5
34520-06	0,6
34520-07	0,7
34520-08	0,8
34520-09	0,9
34520-10	1,0
34520-12	1,2
34520-15	1,5

Drahtumföhrungsnadeln, Drahtspanninstrumente
 Bone wire guides, Bone wire tighteners
 Agujas pasa-hilos, Tensor cierra-hilos
 Aghi passafili, Strumenti tendifili



DEMEL

- Fig. 1 34528-01 31 cm, 12 1/4"
- Fig. 2 34528-02 29 cm, 11 1/2"
- Fig. 3 34528-03 27 cm, 10 1/2"

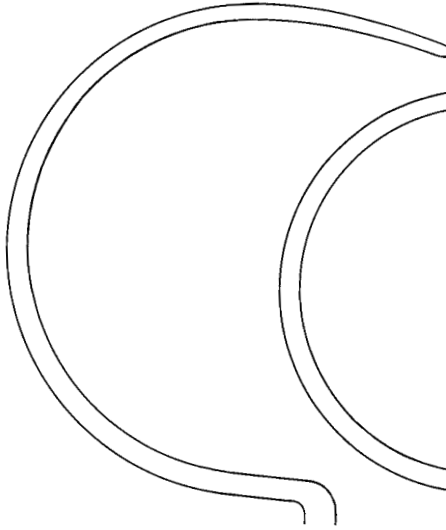


Fig. 1

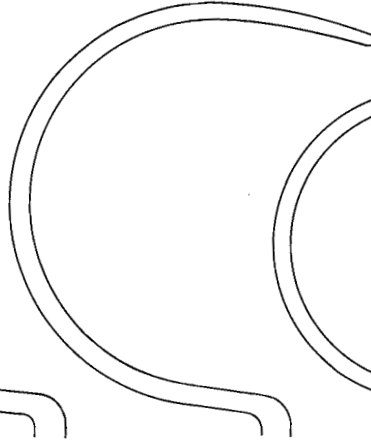


Fig. 2

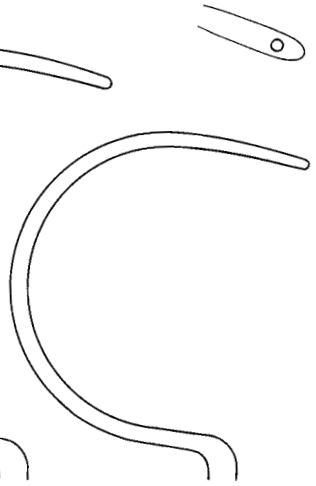
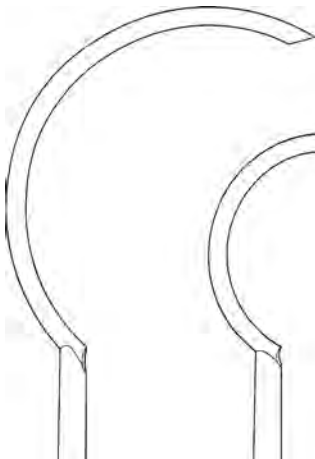
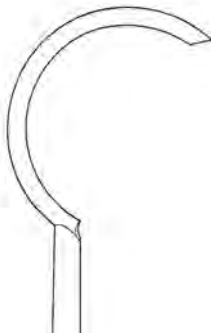


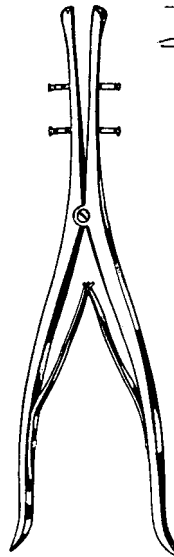
Fig. 3



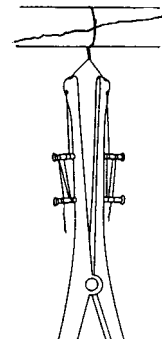
34527-70
27 cm, 10 1/2"



34527-45
24 cm, 9 1/2"



DEMEL
34530-28
28 cm, 11"



LOUTE
34531-21
21 cm, 8 1/4"

Flachzangen, Faßzangen
 Flat Nose Pliers, Seizing Forceps
 Alicates planos, Pinzas para coger alambres
 Tenaglie piatte, Tenaglie per afferrare



34533-17
 17 cm, 6 3/4"



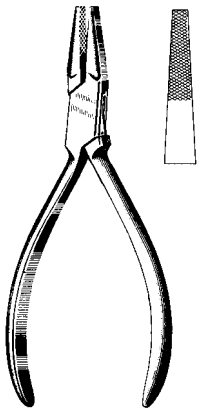
GRIP
 34534-18
 18 cm, 7"



34534-15
 15 cm, 6"



34535-16
 16 cm, 6 1/4"



34536-14
 14 cm, 5 1/2"



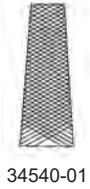
34537-19
 19 cm, 7 1/2"



	2 mm	4 mm	6 mm
	34538-01	34538-02	34538-03
	34539-01 TC	34539-02 TC	34539-03 TC

18 cm, 7"

Flachzangen, Drahtkneifzangen
 Flat Nose Pliers, Wire cutting Pliers
 Alicates planos, Alicates para cortar alambres
 Tenaglie piate, Tenaglie tagliafili



34540-01



34540-02



17 cm, 6 3/4"

34540-18
18 cm, 7"34540-19
18 cm, 7"34540-20
20 cm, 8"

Drahtkneifzangen
Wire cutting Pliers
Alicates para cortar alambres
Tenaglie tagliafili



34541-23 TC 23 cm, 9"

soft wire 3,0 mm
hard wire 2,2 mm



34542-15 TC 15 cm, 6"

Soft wire 2,0 mm
hard wire 1,5 mm



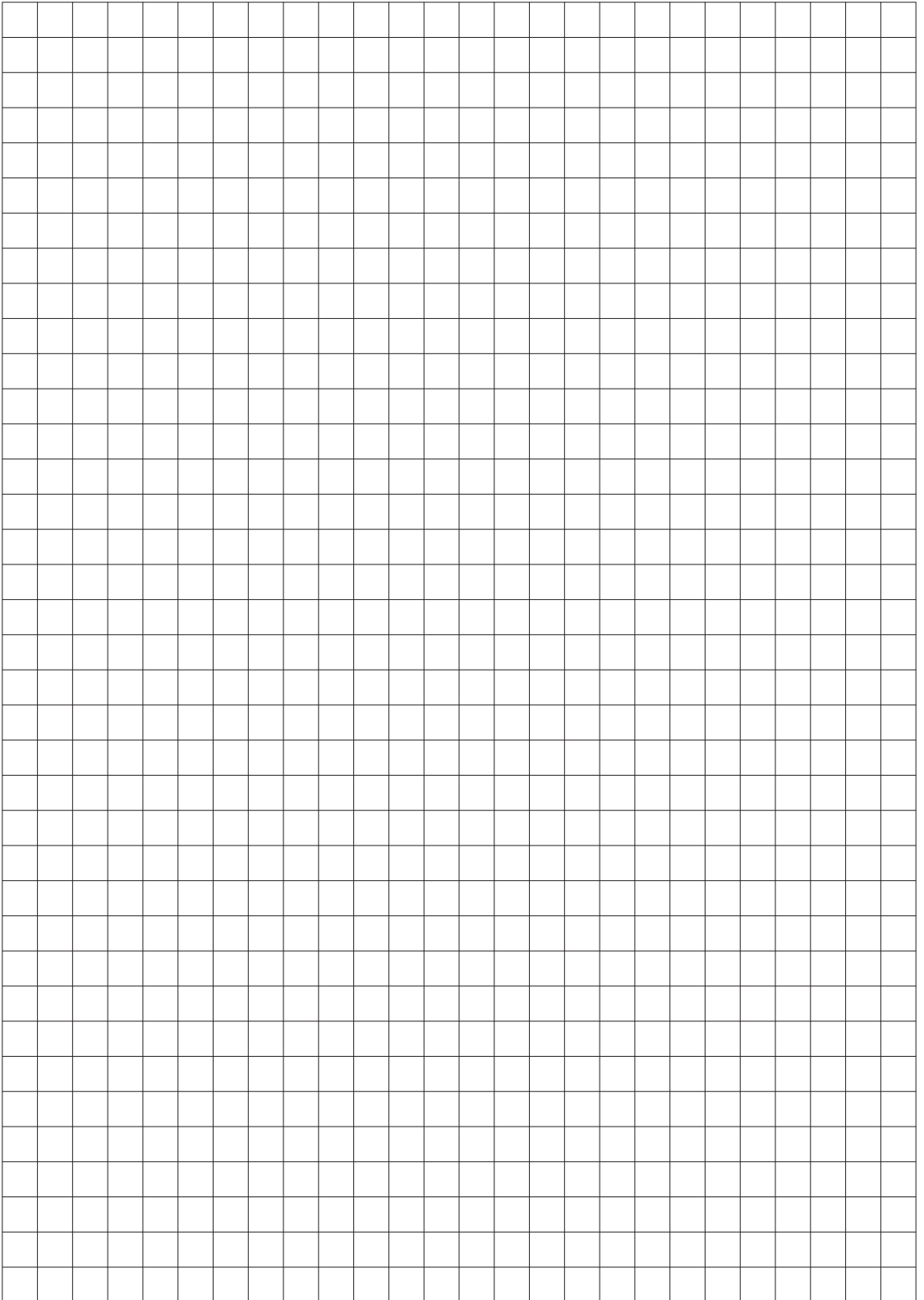
34543-23 TC 23 cm, 9"

Soft wire 3,5 mm
hard wire 2,5 mm

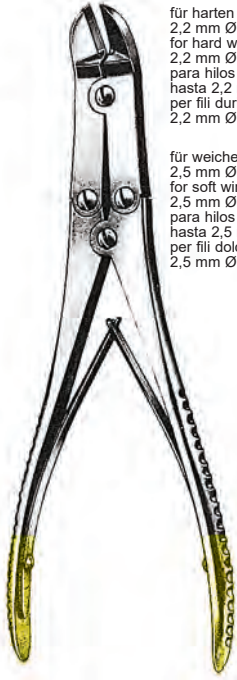


34544-18 TC 18 cm, 7"

Soft wire 2,5 mm
hard wire 1,5 mm



Drahtkneifzangen, Drahtfaßzangen
Wire Cutting Pliers, Wire Seizing Forceps
Alicates para cortar alambres, Pinzas para coger alambres
Tronchese taglianti, Tenaglie per afferrare i fili



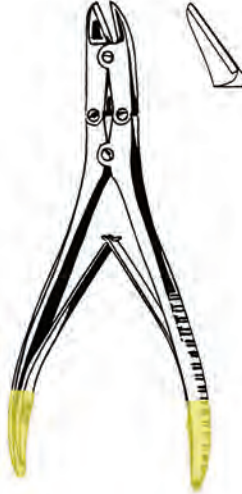
für harten Draht bis
2,2 mm Ø
for hard wires up to
2,2 mm Ø
para hilos duros
hasta 2,2 mm Ø
per fili duri a
2,2 mm Ø

für weichen Draht bis
2,5 mm Ø
for soft wires up to
2,5 mm Ø
para hilos blandos
hasta 2,5 mm Ø
per fili dolci fino a
2,5 mm Ø

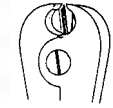
34545-22 TC 22 cm, 8 3/4"

für harten Draht bis 1,6 mm Ø
for hard wires up to 1,6 mm Ø
para hilos duros hasta 1,6 mm Ø
per fili duri a 1,6 mm Ø

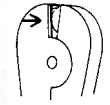
für weichen Draht bis 2,0 mm Ø
for soft wires up to 2,0 mm Ø
para hilos blandos hasta 2,0 mm Ø
per fili dolci fino a 2,0 mm Ø



34546-16 TC 16 cm, 6 1/4"
34546-18 TC 18 cm, 7"



für weichen Draht bis
2,0 mm Ø
for soft wires up to
2,0 mm Ø
para hilos blandos
hasta 2,0 mm Ø
per fili dolci fino a
2,0 mm Ø



für harten Draht bis
1,6 mm Ø
for hard wires up to
1,6 mm Ø
para hilos duros
hasta 1,6 mm Ø
per fili duri a
1,6 mm Ø

34548-18 TC 18 cm, 7"

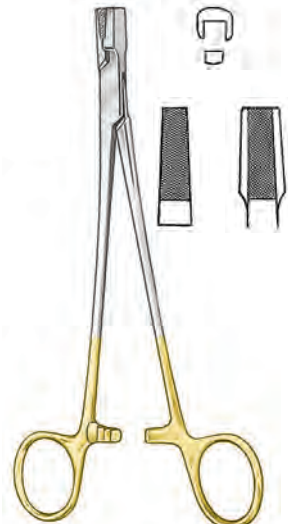


soft wire 1,5 mm
hard wire 1,0 mm

34549-14 TC 14 cm, 5 1/2"



34550-13 13 cm, 5 1/8"
34550-18 18 cm, 7"



34551-17 TC 17 cm, 6 3/4"

Drahtzangen
Wire Twisting Forceps
Pinzas para torcer hilos
Pinza torcifili



CORWIN-HEGAR

34552-16 TC 16 cm, 6 1/4"



BERRY

34556-18 TC 18 cm, 7"



MAYO-HABERISSER



34554-15 TC

15 cm
6"

34555-15 TC



34554-18 TC

18 cm
7"

34555-18 TC



34554-20 TC

20 cm
8"

34555-20 TC

Drahtkneifzange
Pin cutter
Alicate para cortar clavos
Ghigliottina per tagliare fili fino



34557-22 22 cm, 8 ¾"
34557-25 25 cm, 10"
34557-30 30 cm, 11 ¾"



bis 2,2 mm
up to 2,2 mm
hasta 2,2 mm
a 2,2 mm

34558-32 32 cm, 12 ½"



bis 6 mm
up to 6 mm
hasta 6 mm
a 6 mm

34559-47 TC 47 cm, 18 ½"



bis 6,5 mm
up to 6,5 mm
hasta 6,5 mm
a 6,5 mm

34560-57 TC 57 cm 22 ½"

Drahtkneifzange
Wire Cutter
Alicate para alambre
Tronchese tagliafili



HERCULES

34547-23 TC 23 cm / 9"

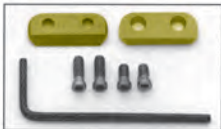
für Bohrdrähte bis max. 3 mm Ø
über 40% Kraftersparnis durch Spezialmechanik
auswechselbare Hartmetallschneiden
auswechselbare Gummibacken
komplett sterilisierbar

for drill wires of max 3 mm Ø
over 40% less power required by special mechanic
exchangeable TC-blades
exchangeable rubber jaws
full sterilisable

para taladros filiformes de max. 3 mm Ø
reducción de la fuerza manual en más de un 40%
placas de tungsteno intercambiables
bocas de goma intercambiables
complemente esterilizable

con riduzione di forza più del 40%
Per fili pertoratori fino a 3 mm
Placche taglienti al TC intercambiabili
Ganasce in gomma intercambiabili
Completamente sterilizzabili

Ersatzteilsets
Spare Part Sets
Juegos de recambios
Set per parti di ricambio



34547-01

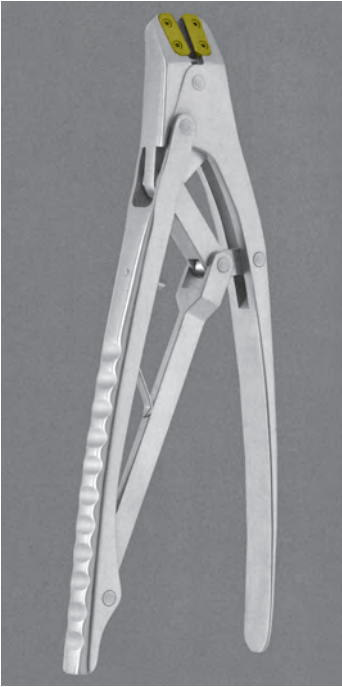
1 Paar Hartmetallschneiden / 2 Paar Schrauben / 1 Inbusschlüssel
1 pair of TC-blades / 2 pairs of screws / 1 Allen key
1 par de placas de tungsteno / 2 pares de tornillos / 1 llave hexagonal
1 Paio di placche TC / 2 Paio di viti da fissaggio / 1 chiave esagonale



34547-03

1 Paar Gummibacken / 1 Paar Schrauben
1 pair of rubber jaws / 1 pair of screws
1 par de bocas de goma / 1 par de tornillos
1 Paio ganasce in gomma / 1 Paio di viti da fissaggio

Drahtkneifzange
Wire Cutter
Alicate para alambre
Tronchese tagliafilii



HERCULES

34547-28 TC 28 cm / 11"

für Bohrdrähte ab 2,5 - 4,0 mm
über 40% Kraftersparnis durch Spezialmechanik
auswechselbare Hartmetallschneiden
auswechselbare Gummibacken
komplett sterilisierbar

for drill wires of 2,5 - 4,0 mm
over 40% less power required by special mechanic
exchangeable TC-blades
exchangeable rubber jaws
full sterilisable

para taladros filiformes de 2,5 - 4,0 mm
reducción de la fuerza manual en más de un 40%
placas de tungsteno intercambiables
bocas de goma intercambiables
complemente esterilizable

con riduzione di forza più del 40%
Per fili pertoratori fino a 2,5 - 4,0 mm
Placche taglienti al TC intercambiabili
Ganasce in gomma intercambiabili
Completamente sterilizzabili

Ersatzteilsets
Spare Part Sets
Juegos de recambios
Set per parti di ricambio



34547-02

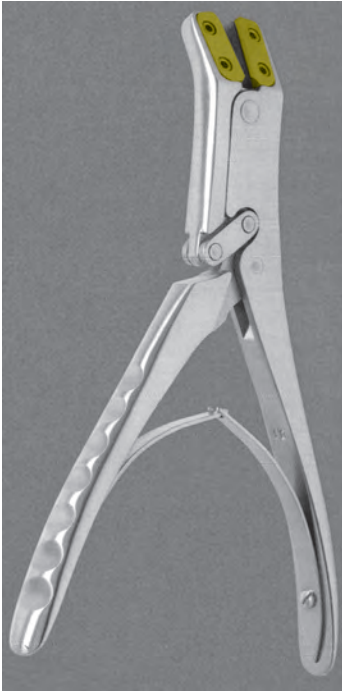
1 Paar Hartmetallschneiden / 2 Paar Schrauben / 1 Inbusschlüssel
1 pair of TC-blades / 2 pairs of screws / 1 Allen key
1 par de placas de tungsteno / 2 pares de tornillos / 1 llave hexagonal
1 Paio di placche TC / 2 Paio di viti da fissaggio / 1 chiave esagonale



34547-03

1 Paar Gummibacken / 1 Paar Schrauben
1 pair of rubber jaws / 1 pair of screws
1 par de bocas de goma / 1 par de tornillos
1 Paio ganasce in gomma / 1 Paio di viti da fissaggio

Drahtkneifzange
Wire Cutter
Alicate para alambre
Tronchese tagliafili


HERCULES
35548-18 TC 18 cm / 7"

für Bohrdrähte bis max. Ø 2,2 mm
über 40% Kraftersparnis durch Spezialmechanik, auswechselbare Hartmetallschneiden
auswechselbare Gummibacken
komplett sterilisierbar

for drill wires of max 0 2,2 mm
over 40% less power required by special mechanic
exchangeable TC-blades
exchangeable rubber jaws
full sterilisable

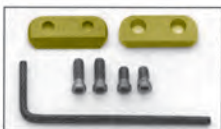
para taladros filiformes de max. Ø 2,2 mm
reducción de la fuerza manual en más de un 40%
placas de tungsteno intercambiables
bocas de goma intercambiables
complemente esterilizable

con riduzione di forza più del 40%
Per fili perforatori da 2,2 mm
Utilizzabile a scelta per mano sinistra e destra
Placche taglienti al TC intercambiabili
Ganasce in gomma intercambiabili
Completamente sterilizzabili

für Rechtshänder / tor right-handers /
para la mano derecha / per mano destra



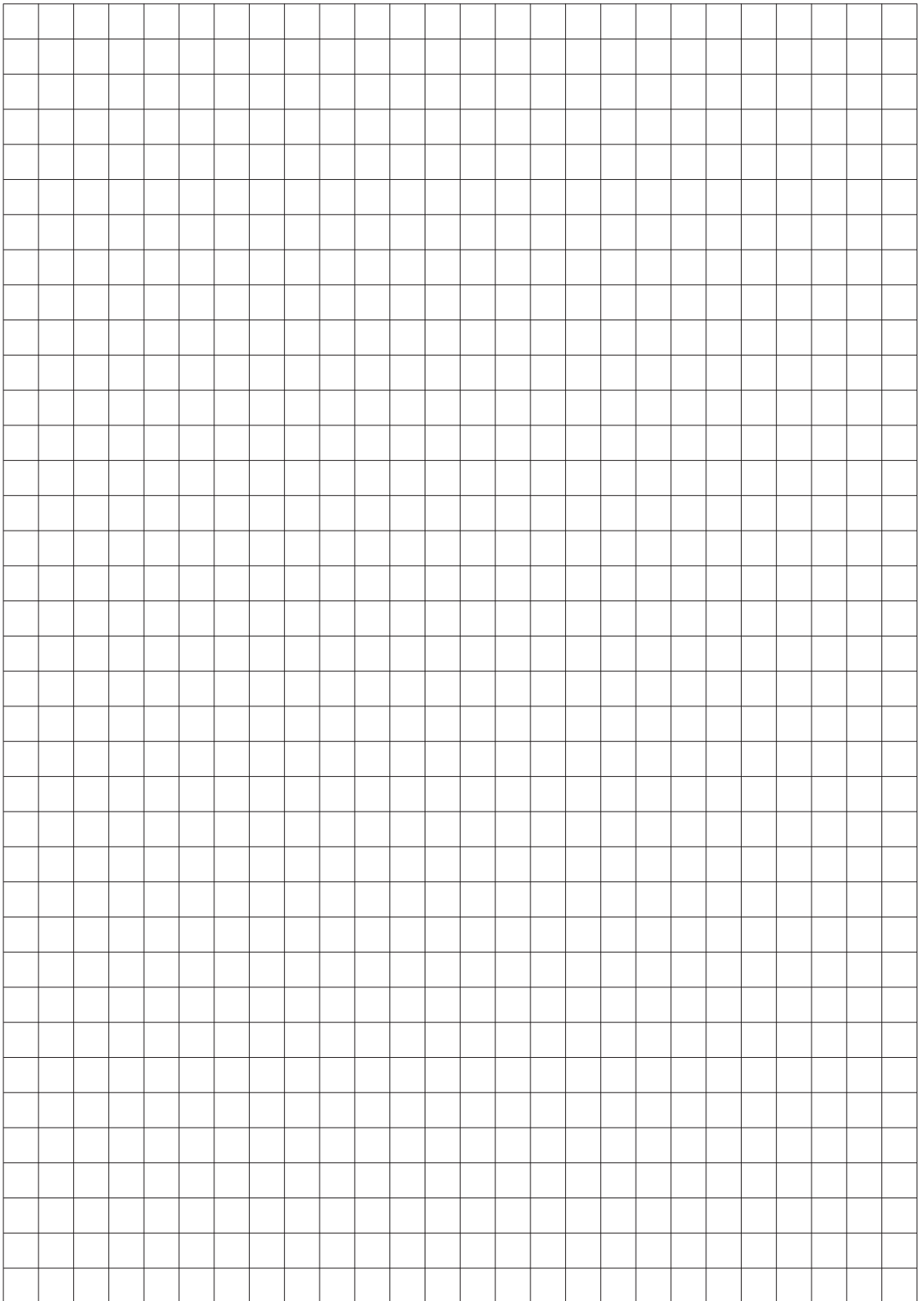
Ersatzteilsets
Spare Part Sets
Juegos de recambios
Set per parti di ricambio


35547-01

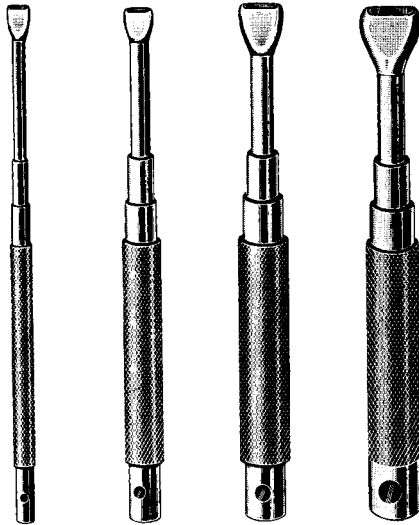
1 Paar Hartmetallschneiden / 2 Paar Schrauben / 1 Inbusschlüssel
1 pair of TC-blades / 2 pairs of screws / 1 Allen key
1 par de placas de tungsteno / 2 pares de tornillos / 1 llave hexagonal
1 Paio di placche TC / 2 Paio di viti da fissaggio / 1 chiave esagonale


34547-03

1 Paar Gummibacken / 1 Paar Schrauben
1 pair of rubber jaws / 1 pair of screws
1 par de bocas de goma / 1 par de tornillos
1 Palo ganasce in gomma / 1 Paio di viti da fissaggio

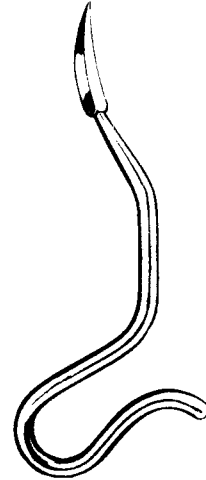


Instrumentarium für Ender und Küntscher Nägel
 Instruments for ender and Küntscher Nails
 Instrumental para Clavos Ender y Küntscher
 Strumentario per chiodi di Ender e Küntscher



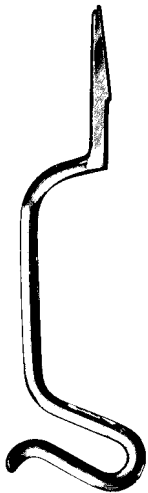
	34562-24	34562-32	34562-48	34562-64
f./p. Ø	2,4 mm	3,2 mm	4,8 mm	6,4 mm

Ein- und Ausschlaginstrumente für Ender-Nägel
 Driver-extractors for Ender nails
 Impactores-Extractores para clavos de Ender
 Impattatore-Estrattore per chiodi di Ender



KÜNTSCHER	26 cm, 10 1/4"
34570-01	8 mm
34570-02	10 mm

Vorböhrer zum Öffnen der Markhöhle
 Reamers for medullary cave
 Perforadores para la cavidad medular
 Alesatore per l'apertura del midollo



KÜNTSCHER
 34573-35 35 cm, 13 3/4"
 Aufreiber für Oberschenkel
 Reamer for femur
 Perforador para fémur
 Alesatore per femore



mm Ø L = 60 cm, 23 3/4"	
3,5	34583-60
4,0	34584-60
5,0	34585-60

Führungsspiße
 Guide pins
 Guía-conductora para clavos medulares
 Guida conduttrice



für Nägel
 for nails
 para clavos
 per chiodi

Ø 6-8 mm	34588-01
----------	----------

Ø 9-12 mm	34588-02
-----------	----------

Ø 12-17 mm	34588-03
------------	----------

KÜNTSCHER 19 cm, 7 1/2"

Fertigschläger
 Nail impactors
 Impactor final
 Impattatore finale

Instrumentarium für Küntscher Nägel
 Instruments for Küntscher Nails
 Instrumental para Clavos Küntscher
 Strumentario per chiodi di Küntscher



34590-01



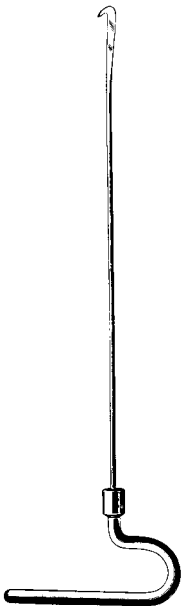
34590-02

KÜNTSCHER

34590-00 63 cm, 24 3/4"

komplett mit 2 Haken 34590-01/02
 complete with 2 hooks 34590-01/02
 completo con 2 ganchos 34590-01/02
 completo con 2 ganci 34590-01/02

Extraktor
 Nail extractor
 Aparato extractor
 Estrattore



Extraktionshaken
 Extraction hooks
 Ganchos extractores
 Gancio d'estrazione

34596-29 29 cm 11,4"
 34596-37 37 cm 14,5"
 34596-42 42 cm 16,5"
 34596-49 49 cm 19,3"



Markraumborher
 Intramedullary drills
 Perforadores medulares
 Perforatore intramidollare

Ø
 6,0 mm 34597-06
 7,0 mm 34597-07
 8,0 mm 34597-08
 9,0 mm 34597-09
 10,0 mm 34597-10
 11,0 mm 34597-11
 12,0 mm 34597-12
 13,0 mm 34597-13
 14,0 mm 34597-14
 15,0 mm 34597-15
 16,0 mm 34597-16
 17,0 mm 34597-17
 18,0 mm 34597-18
 19,0 mm 34597-19
 20,0 mm 34597-20

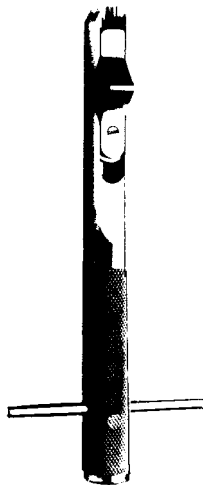
Instrumentarium für Küntscher Nägel
Instruments for Küntscher Nails
Instrumental para Clavos Küntscher
Strumentario per chiodi di Küntscher



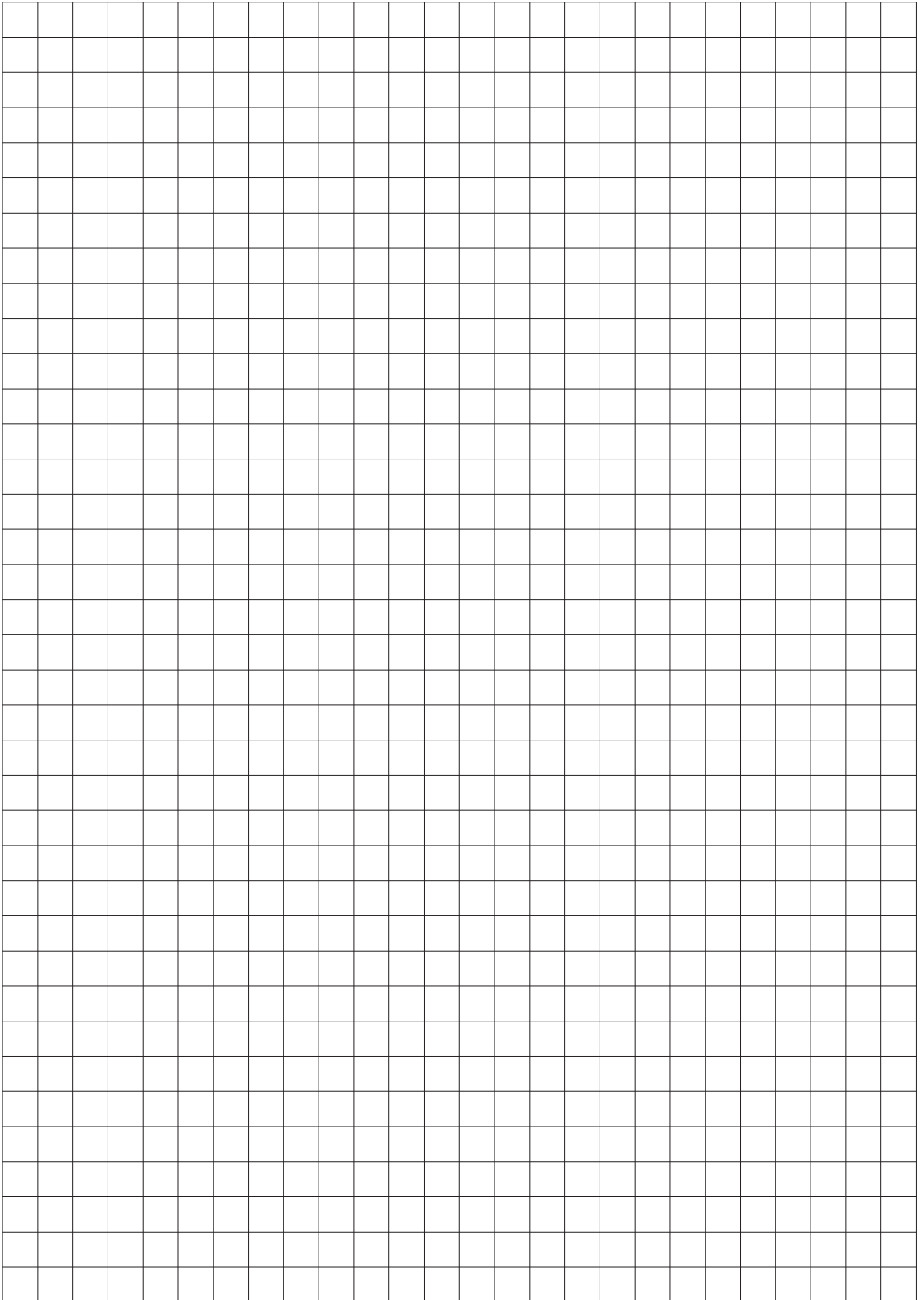
Einschläger / Nail Inserter
Introducer clavos / Impattore
34612-00



Impactor
34613-00



Impactor-Extractor
Impattore-Estrattore
34617-00



Schraubenzieher
Screw Drivers
Destornilladores
Cacciaviti

6 mm



LANE
34620-25 25 cm, 10"

3,5 mm



34624-01



34624-02



34624-03



WILLIAMS
24 cm, 9 1/2"



34628-01
25 cm, 10"



34628-02
25 cm, 10"



PHILIPS
34629-01
25 cm, 10"



mit Ferrozellgriff
with Ferrozell handle
con mango de Ferrozell
con manico di Ferrozell



1,5 mm

34628-15
20 cm, 8"



2,5 mm

34628-25
25 cm, 10"



3,5 mm

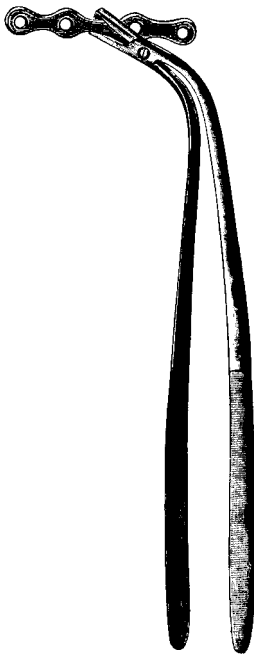
34628-35
25 cm, 10"

Schraubenzieher
Screw Drivers
Destornilladores
Cacciaviti



LANE
34632-25 25 cm, 10"
Kreuzschlitzschraubenzieher
Screwdriver for cross slotted head
Destornillador para tornillos con ranura en cruz
Cacciavite a croce

Haltezangen, Biegehebel
 Holding Forceps, Bender
 Pinzas para sostener placas y tornillos, Palanca
 Pinza portaplacca, leva piega placche



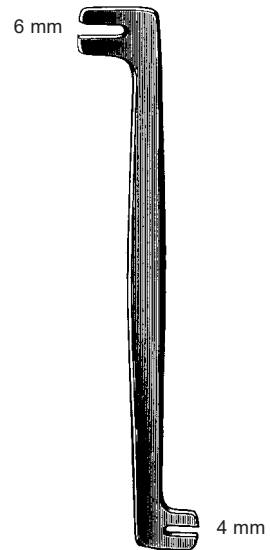
LANE
 34637-23 23 cm, 9"

Knochenplatten-Haltezange
 Plate Holding Forceps
 Pinza para sostener placas
 Pinza portaplacche



LANE
 34639-22 22 cm, 8 3/4"

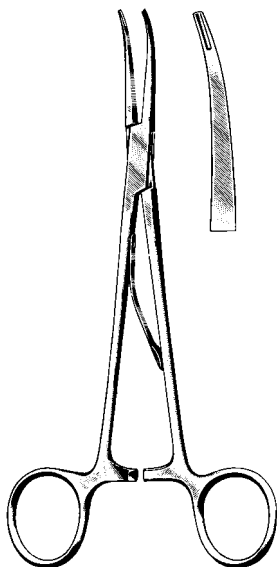
Schraubenthaltezange
 Screw Holding Forceps
 Pinza para sostener tornillos
 Pinza portaviti



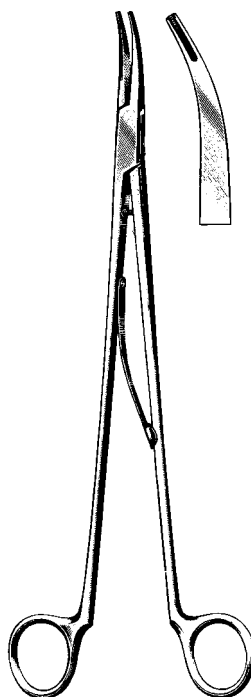
LANE
 34640-18 25 cm, 10"

Biegehebel f. Knochenplatten
 Plate Bender
 Palanca para doblar placas
 Leva piegaplacche

Anlegezangen, Silberklammern
 Applying Fcps. Clips
 Pinzas aplicadoras, Grapas
 Pinza per applicare, Agrafes



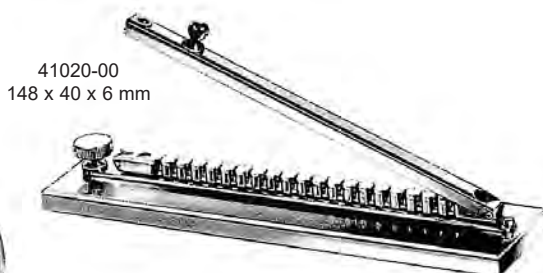
McKENZIE
 41011-15 15 cm, 6"
 41011-19 19 cm, 7 1/2"



SMITHWICK
 41015-23 23 cm, 9"
 41015-26 26 cm, 10 1/4"

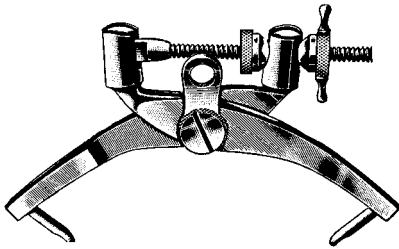


OLIVECRONA-TOENNIS
 41019-14



41020-00
 148 x 40 x 6 mm

Schädelhalter, Kopfhautklammer, Anlegezange
Cervical Traction Tongs, Clips, Applying Forceps
Pinzas de tracción craneal, Clips, Pinza para aplicar clips
Pinze per trazione craniale, Pinza per applicare



CRUTCHFIELD
41025-01



CRUTCHFIELD
41025-02



41026-35
3,5 mm Ø

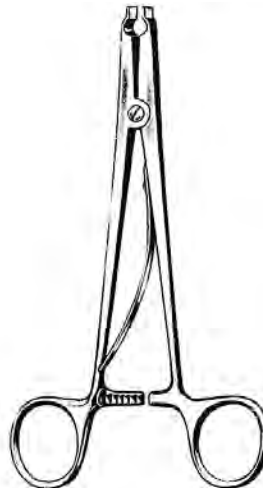


41026-50
5 mm Ø

Stainless steel
Acciaio inox



RANEY
41027-00



RANEY
41028-00 16 cm, 6 1/4"

Nervhaken, Durahaken
 Nerve Hooks, Dura Hooks
 Ganchos para nervios y para dura-madre
 Unicini per nervi e per dura-madre



DANDY
 41051-20
 20 cm, 8"



DANDY
 41052-20
 20 cm, 8"



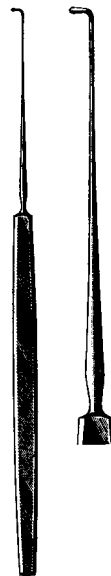
DANDY
 41053-20
 20 cm, 8"

6 mm



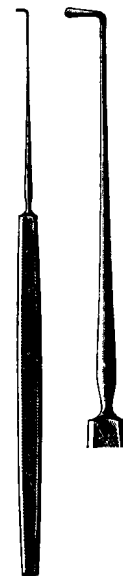
CRILE
 41054-20
 20 cm, 8"

Fig. 1, 8 mm



CUSHING
 41056-18 18 cm, 7"
 41056-28 28 cm, 11"

Fig. 2, 10 mm



CUSHING
 41058-18 18 cm, 7"
 41058-28 28 cm, 11"

Nervhaken, Durahaken
Nerve Hooks, Dura Hooks
Ganchos para nervios y para dura-madre
Unicini per nervi e per dura-madre



GRAHAM
41061-16
16,5 cm, 6 ½"



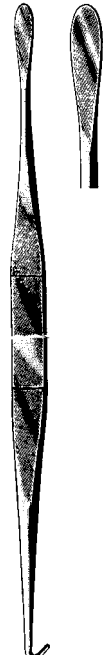
SACHS
41064-16
18,5 cm, 7 ¼"



ADSON
41068-20
20 cm, 8"

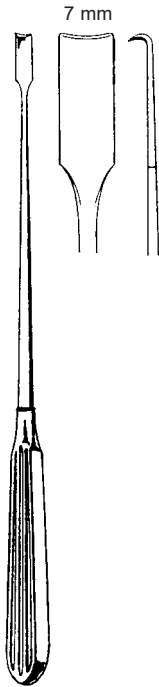


ADSON
41069-20
20 cm, 8"



SMITHWICK
41070-29
29 cm, 11,4"

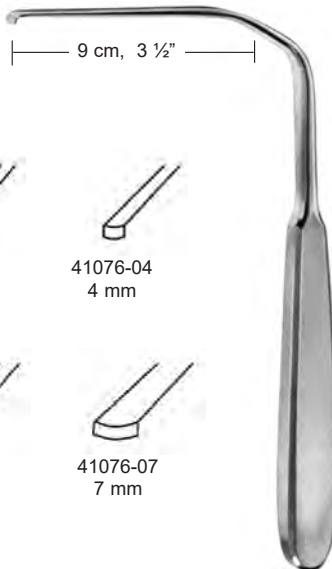
Nervwurzelnhaken
 Nerve Root Retractors
 Separadores de raíz de nervios
 Uncini per le radici dei nervi



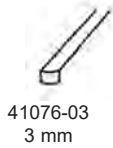
SCOVILLE
 41074-23
 23 cm, 9"



HOLSHER
 41075-24
 24 cm, 9 1/2"



HESS
 17,5 cm, 7"



41076-03
 3 mm



41076-04
 4 mm

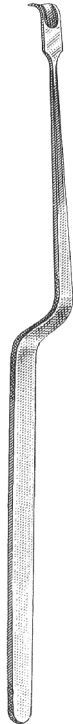


41076-05
 5 mm



41076-07
 7 mm

Nervwurzelnhaken
Nerve Root Retractors
Separadores de raíz de nervios
Uncini per le radici dei nervi

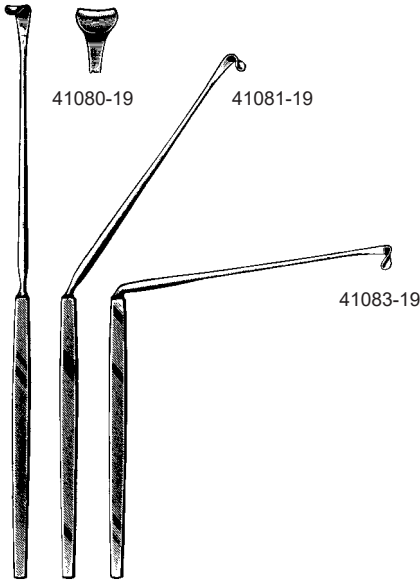


D'ERRICO
41078-23
23 cm, 9"



LOVE
41079-21
21 cm, 8 1/4"

Nervwurzelhaken, Galeahaken
 Nerve Root Retractors, Galea Hooks
 Separadores de raiz de nervios, Gancho para galea
 Uncini per le radici dei nervi, Uncini galea



LOVE
 41080-19 – 41083-19
 19 cm, 7 ½"

SCOVILLE
 41085-20
 20 cm, 8"



DeMARTEL
 41090-33
 33 cm, 13"



YASARGIL
 41091-31
 31 cm, 12 ¼"

Galeahaken
 Galea Hooks
 Gancho p/galea
 Gancio p/galea

Ø 7 mm

4 mm



YASARGIL
 41091-41
 41 cm, 16"

Ø 9 mm

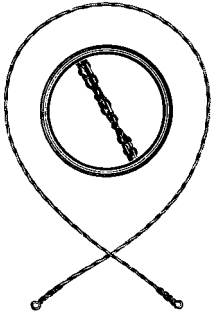
6 mm

Schädelstanze
Cranial Punch
Pinzas sacabocado craneal
Pinza per craniotomia

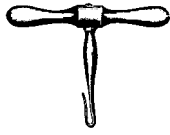


CONE
41097-22
22,5 cm 9"

Drahtsägen, Schädelzange, Dura Dissektoren
 Wire Saws, Skull Punches, Dura Dissectors
 Sierras de hilo, Pinzas sacabocado craneal, Elevadores para la duramadre
 Fili sega, Pinza per craniotomia, Scollatori per duramadre



- | | |
|------------|-------------|
| OLIVECRONA | cm |
| 41092-30 | 30, 11 3/4" |
| 41092-40 | 40, 15 3/4" |
| 41092-50 | 50, 19 3/4" |
| 41092-60 | 60, 23 3/4" |
| 41092-70 | 70, 27 1/2" |



GIGLI
 41094-00
 Drahtsägen-Handgriff
 Wire Saw Handle
 Mango de gancho
 Manico con uncino



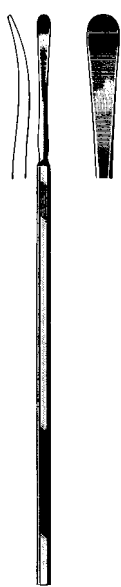
DeVILBISS
 41096-21
 21 cm, 8 1/4"



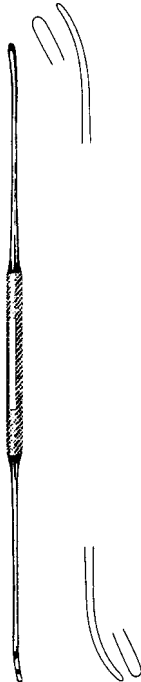
TOENNIS
 41141-25
 25 cm, 10"



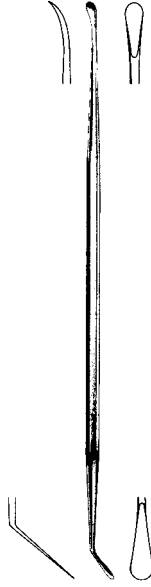
SACHS
 41143-21
 21 cm, 8 1/4"



SACHS
 41145-21
 21 cm, 8 1/4"



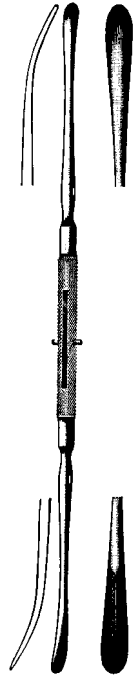
OLIVECRONA
 41146-18 18 cm, 7"
 41146-24 24 cm, 9 1/2"



MILLIGAN
 41147-21
 21 cm, 8 1/4"

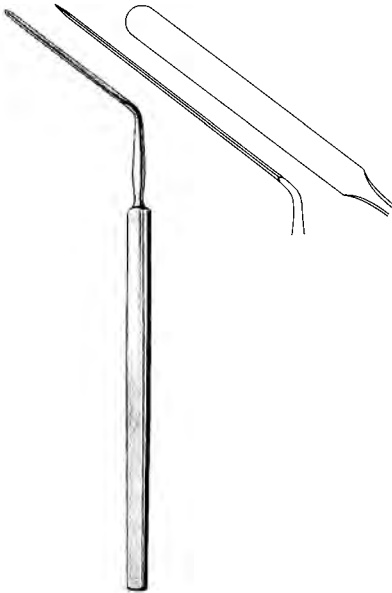


41149-22
 22 cm, 8 3/4"



DAVIS
 41151-24
 24 cm, 9 1/2"

Dura Dissektoren
Dura Dissectors
Elevadores
Scollatori



HORSLEY
41155-20
20 cm, 8"



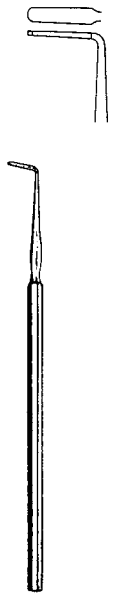
WOODSON
41156-18
18 cm, 7"



FRAZIER
41158-01
15 cm, 6"



HOEN
41158-02
15 cm, 6"



HOEN
41158-03
15 cm, 6"



PENFIELD
41161-01
17,5 cm, 6,9"



PENFIELD
41161-02
19,5 cm, 7 3/4"



PENFIELD
41161-03
19,5 cm, 7 3/4"



PENFIELD
41161-04
21,5 cm, 8 1/2"



PENFIELD
41161-05
29 cm, 11,4"

Hypophyse Pinzetten, Küretten
 Hypophyseal Forceps, Curette
 Pinzas para hipófisis, Curetas
 Pinze per ipofisi, Curette



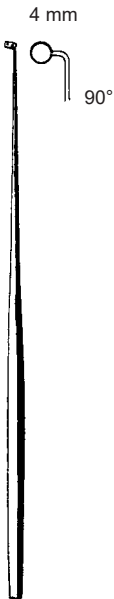
ADSON
 41210-23
 23 cm, 9"



ADSON
 41211-23
 23 cm, 9"



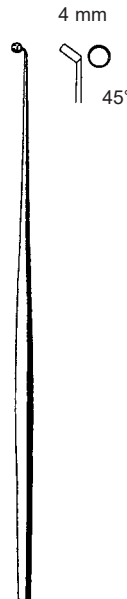
ADSON
 41213-23
 23 cm, 9"



RAY
 41221-00
 19 cm, 7 1/2"



RAY
 41222-00
 19 cm, 7 1/2"

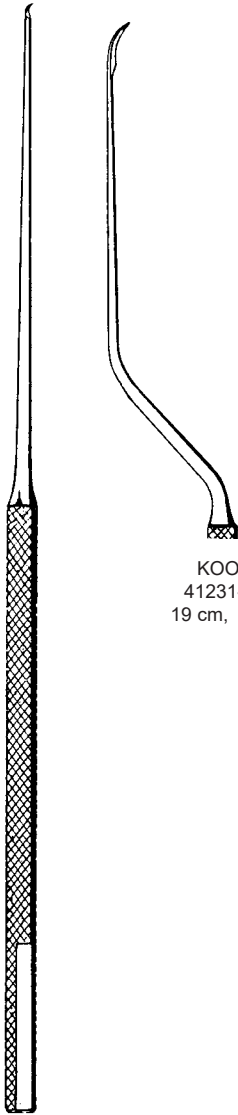


RAY
 41223-00
 19 cm, 7 1/2"

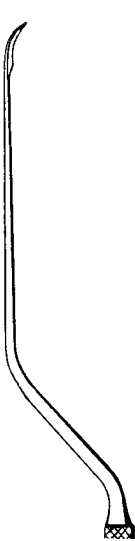


RAY
 41224-00
 19 cm, 7 1/2"

Gefäß-Messer, Haken, Sonden
 Vessel-Knives, Hooks, Probes
 Bisturies, Ganchos, Sondas
 Bisturi, Uncino, Sonde



JACOBSON
 41230-19
 19 cm, 7 1/2"



KOOS
 41231-19
 19 cm, 7 1/2"



FISCH
 41236-19
 19 cm, 7 1/2"
 Durahaken
 Dura Hook
 Ganchito para dura-madre
 Uncino dura madre



FISCH
 41237-19
 19 cm, 7 1/2"
 Feines Häkchen
 Delicate Hook
 Ganchito muy fino
 Uncino molto fino



JACOBSON
 41238-19
 19 cm, 7 1/2"
 Knopfsonde
 Buttoned Probe
 Sonda abotonada
 Sonda bottonuta



JACOBSON
 41239-19cm
 19 cm, 7 1/2"
 Doppelsonde
 Twin Probe
 Sonda doble
 Sonda doppia

Nervhäkchen, Hirnspatel, Saugrohre
 Nerve Hooks, Brain Spatulas, Suction Tubes
 Ganchos para nervios, Espatulas cerebrales, Tubos de aspiración
 Uncini per nervi, Spatole cerebrali, Tubi aspirazioni



KRAYENBÜHL
 41242-19
 19 cm, 7 1/2"



KRAYENBÜHL
 41243-19
 19 cm, 7 1/2"



KRAYENBÜHL
 41244-19
 19 cm, 7 1/2"

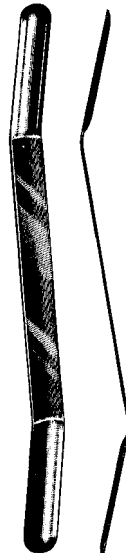


KRAYENBÜHL
 41245-19
 19 cm, 7 1/2"



CUSHING
 18 cm, 7"
 41250-11 8x10 mm
 41250-15 13x15 mm
 41250-18 16x18 mm

konkav
 concave
 cóncavo
 concavi



OLIVECRONA
 18 cm, 7" mm
 41253-07 7/ 9
 41253-11 11/13
 41253-15 15/18
 41253-18 18/22



BARON
 41299-03 3FR 1,0 mm
 41299-05 5FR 1,6 mm
 41299-07 7FR 2,3 mm

Hirnspatel, Saugrohre, Punktionskanüle
 Brain Spatulas, Suction Tubes, Puncture Cannulas
 Espatulas cerebrales, Tubos de aspiración, Tubo de punción
 Spatole cerebrali, Tubi aspirazioni, cannula per punzione



biegsam
 malleable
 maleable
 malleabile

DAVIS	18 cm, 7"
41254-06	6 mm, ¼"
41254-10	9 mm, ⅜"
41254-13	13 mm, ½"
41254-16	16 mm, ⅝"
41254-19	19 mm, ¾"
41254-25	25 mm, 1"
41254-32	32 mm, 1 ¼"
41254-38	38 mm, 1 ½"

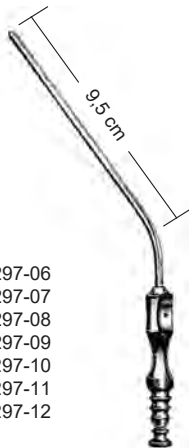


ADSON
 41290-21
 21 cm, 8 ¼"
 ø 4 mm



isoliert
 isolated
 isolada
 isolato

FERGUSSON
 41294-40
 18 cm, 7"
 ø 4 mm, 90°



mm	Charr.		↙
	F.G.	30°	
Ø 1,7	5	41295-05	
Ø 2,0	6	41295-06	41297-06
Ø 2,3	7	41295-07	41297-07
Ø 2,7	8	41295-08	41297-08
Ø 3,0	9	41295-09	41297-09
Ø 3,3	10	41295-10	41297-10
Ø 3,7	11	41295-11	41297-11
Ø 4,0	12	41295-12	41297-12
Ø 5,0	15	41295-15	

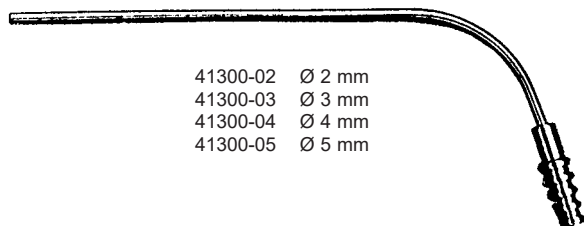
FRAZIER /FERGUSSON
 41295-06 – 41297-12
 19 cm, 7 ½"



FRAZIER /FERGUSSON
 41298-12
 12 cm, 4 ¾" / 3 mm

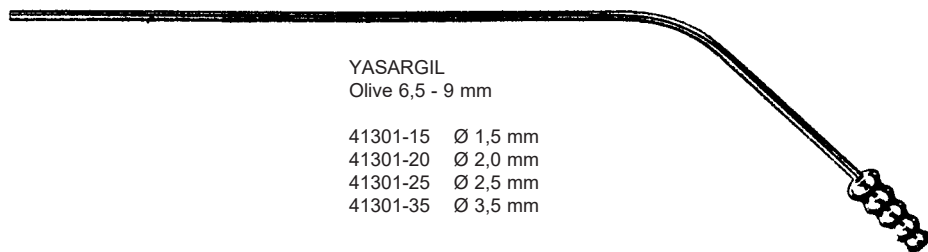
Saugrohre
Suction Tubes
Tubos de aspiración
Tubi aspirazioni

11 cm, 4,4"



41300-02 Ø 2 mm
41300-03 Ø 3 mm
41300-04 Ø 4 mm
41300-05 Ø 5 mm

15 cm, 6"



YASARGIL
Olive 6,5 - 9 mm

41301-15 Ø 1,5 mm
41301-20 Ø 2,0 mm
41301-25 Ø 2,5 mm
41301-35 Ø 3,5 mm



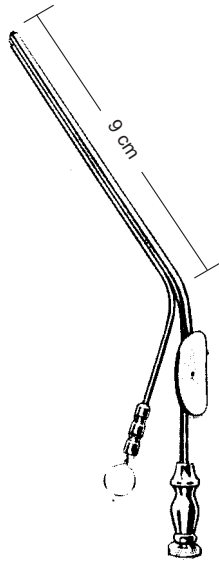
ZÖLLNER
41302-02



0,5 mm Ø 41306-05
0,7 mm Ø 41306-07
0,9 mm Ø 41306-09
1,2 mm Ø 41306-12

Kanüle für Sauggriff für ZÖLLNER und WULLSTEIN
Tip for Suction Handle for ZÖLLNER and WULLSTEIN
Cánula para mango t ZÖLLNER y WULLSTEIN
Cannula per manico di aspirazione t ZÖLLNER e WULLSTEIN

Saugrohre
Suction Tubes
Tubos de aspiración
Tubi aspirazioni

**HOUSE**

9 cm, 3 1/2"

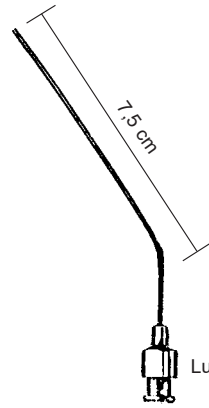
41303-09	Ø 0,9 x 0,7 mm
41303-12	Ø 1,2 x 0,9 mm
41303-15	Ø 1,5 x 1,2 mm
41303-18	Ø 1,8 x 1,8 mm
41303-25	Ø 2,5 x 2,0 mm
41303-30	Ø 3,0 x 2,0 mm
41303-45	Ø 4,5 x 2,0 mm

Saugrohre, Saugkanülen
 Suction Tubes, Suction Cannulae
 Tubos de aspiración, Cánulas para aspiración
 Tubi aspirazioni, Cannule per aspirazione



Sauggriff
 Suction Handle
 Mango de aspiración
 Manico per aspirazione

WULLSTEIN
 41307-00



Kanüle für Sauggriff
 Tip for Suction Handle
 Cánula para mango
 Cannula per manico
 di aspirazione

Luer-Lock

ROSEN
 10 cm, 4"

0,5 mm Ø 41305-05	1,2 mm Ø 41305-12
0,6 mm Ø 41305-06	1,5 mm Ø 41305-15
0,7 mm Ø 41305-07	1,8 mm Ø 41305-18
0,8 mm Ø 41305-08	2,0 mm Ø 41305-20
0,9 mm Ø 41305-09	2,5 mm Ø 41305-25
1,0 mm Ø 41305-10	3,0 mm Ø 41305-30

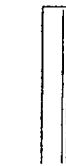


Charr. 6 41304-06 Ø 2,0 mm
 Charr. 8 41304-08 Ø 2,5 mm
 Charr. 10 41304-10 Ø 3,0 mm

PLESTER
 30°



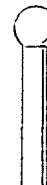
biagsam
 malleable
 maleable
 malleabile



Ø 3 mm
 41307-03



Ø 4 mm
 41307-04



Ø 5 mm
 41307-05



Ø 6 mm
 41307-06

SCHMID
 15 cm, 6"

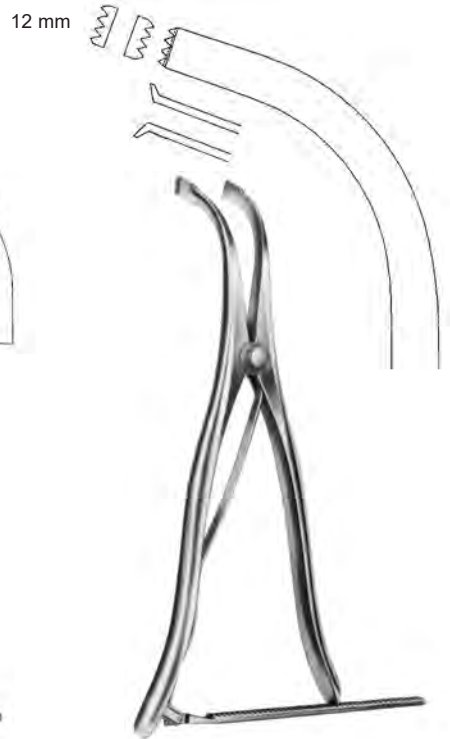
Wirbelkörperspreizer
 Lamina Spreaders
 Separadores para cuerpos vertebrales
 Divaricatori per corpi vertebrali



CLOWARD
 41401-16
 16 cm, 6 ¼"



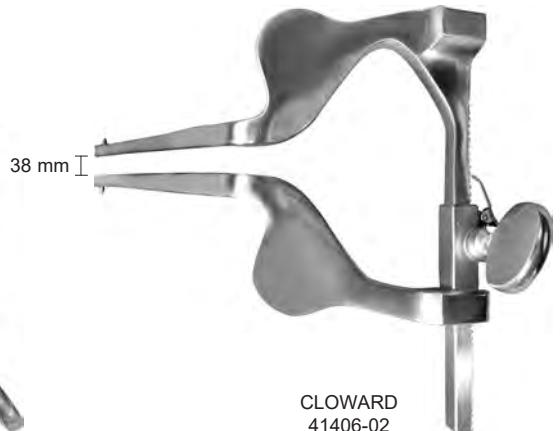
INGE
 41405-17
 17 cm, 6 ¾"



INGE
 41405-27
 27 cm, 10 ½"

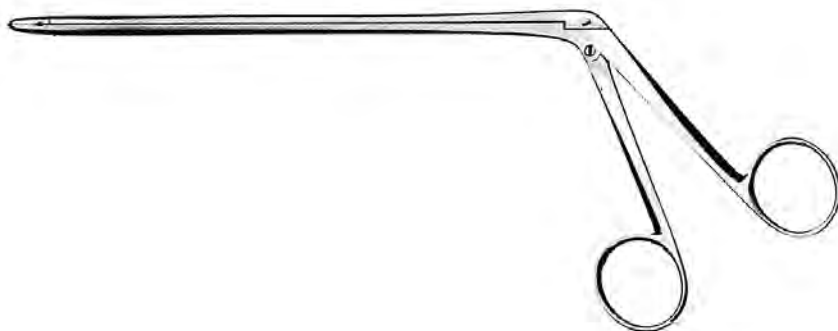


CLOWARD
 41406-01
 12,5 cm, 5"



CLOWARD
 41406-02
 7,6 cm, 3"

Laminektomie Zangen
 Laminectomy Rongeurs
 Pinzas cortantes para laminectomia
 Pinze taglienti per laminectomia



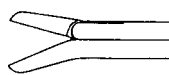
CUSHING
2 mm



2x10 mm L
 41420-01 12,5 cm
 41421-01 15,0 cm
 41422-01 18,0 cm



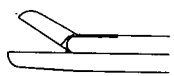
2x10 mm/45° L
 41420-02 12,5 cm
 41421-02 15,0 cm
 41422-02 18,0 cm



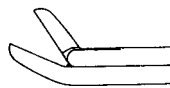
2x10 mm/45° L
 41420-03 12,5 cm
 41421-03 15,0 cm
 41422-03 18,0 cm

LOVE-GRUENWALD

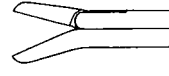
3 mm



3x10 mm L
 41430-01 12,5 cm
 41431-01 15,0 cm
 41432-01 18,0 cm



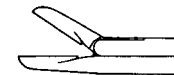
3x10 mm/45° L
 41430-02 12,5 cm
 41431-02 15,0 cm
 41432-02 18,0 cm



3x10 mm/45° L
 41430-03 12,5 cm
 41431-03 15,0 cm
 41432-03 18,0 cm

SPURLING

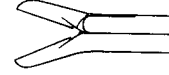
4 mm



4x10 mm L
 41440-01 12,5 cm
 41441-01 15,0 cm
 41442-01 18,0 cm

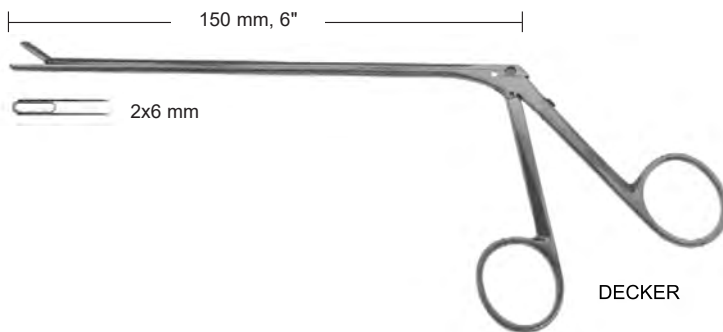
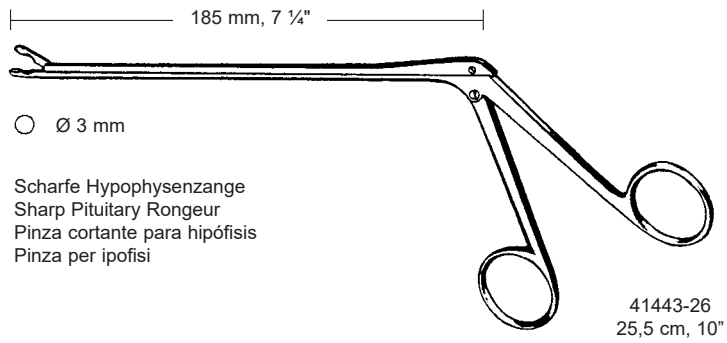


4x10 mm/45° L
 41440-02 12,5 cm
 41441-02 15,0 cm
 41442-02 18,0 cm

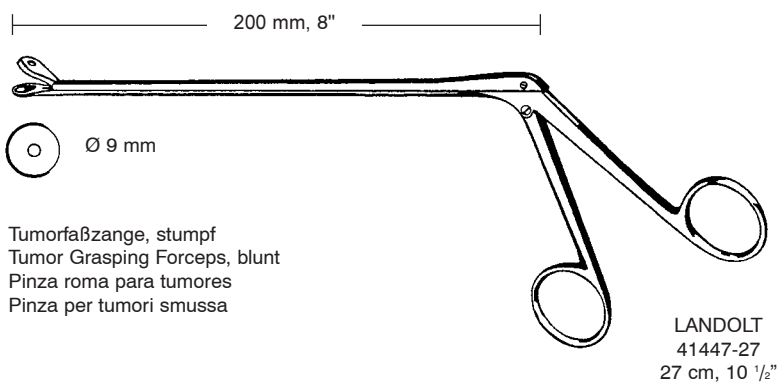
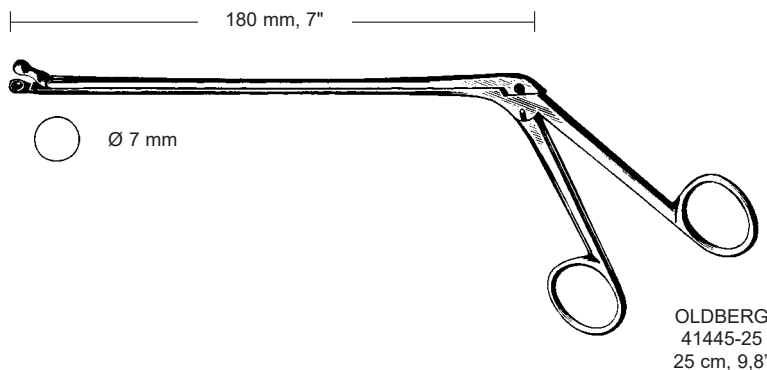


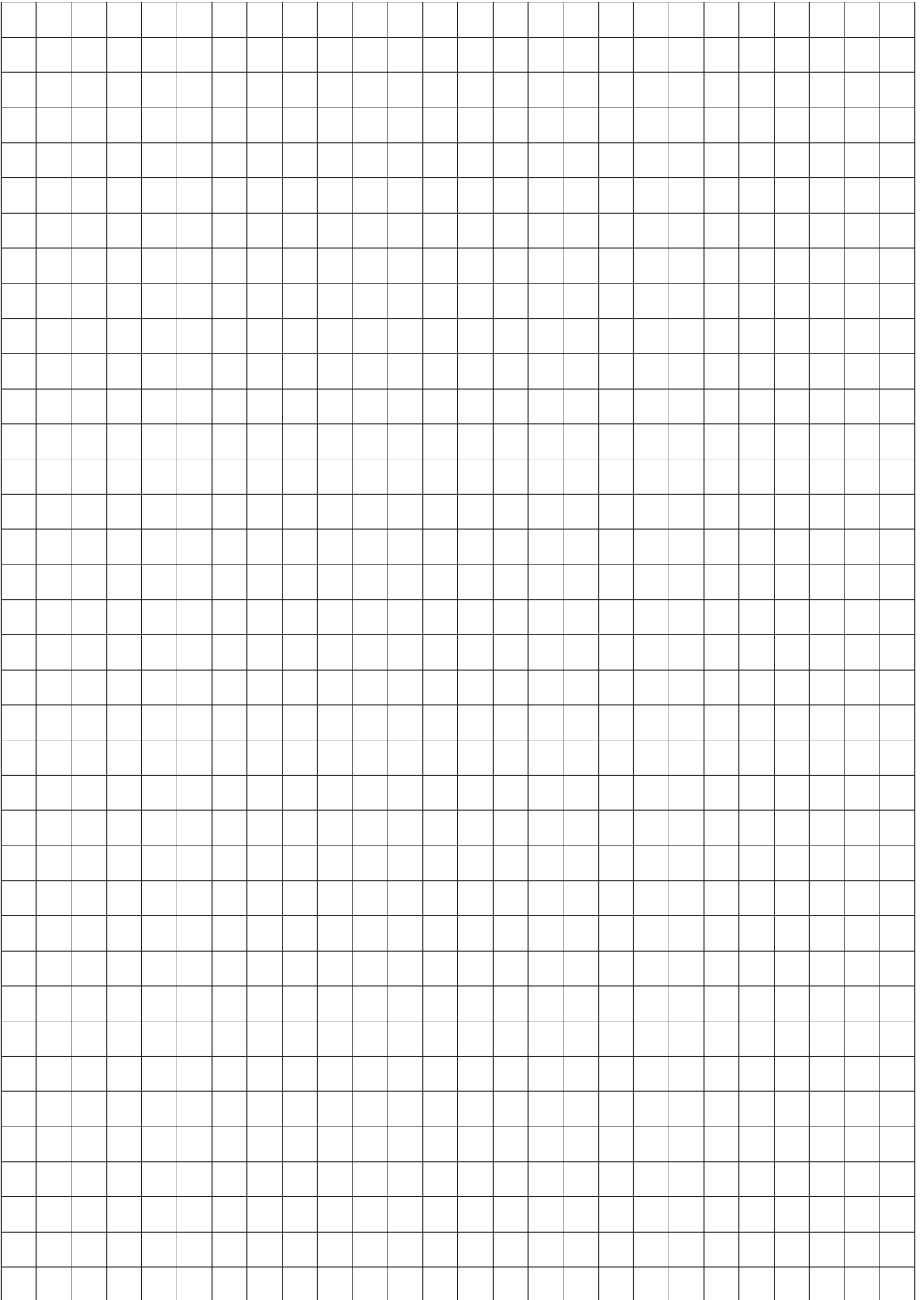
4x10 mm/45° L
 41440-03 12,5 cm
 41441-03 15,0 cm
 41442-03 18,0 cm

Laminektomie Zangen
Laminectomy Rongeurs
Pinzas cortantes para laminectomia
Pinze taglianti per laminectomia

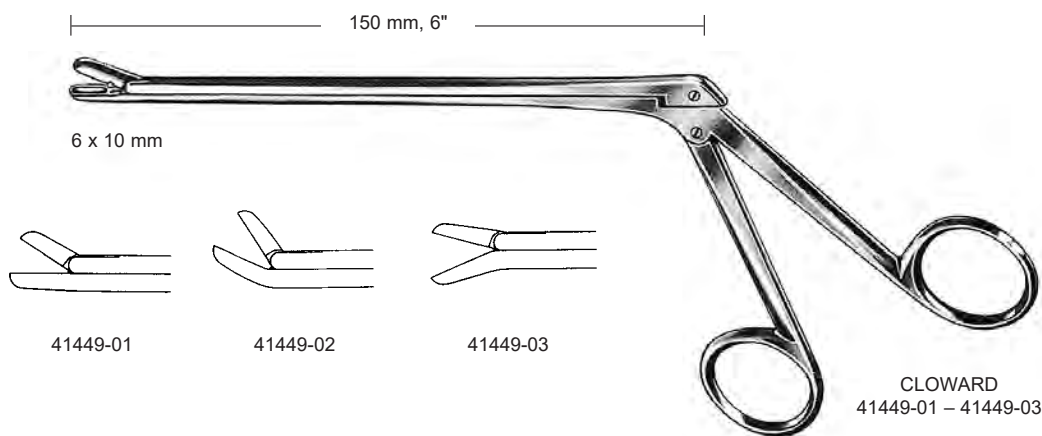
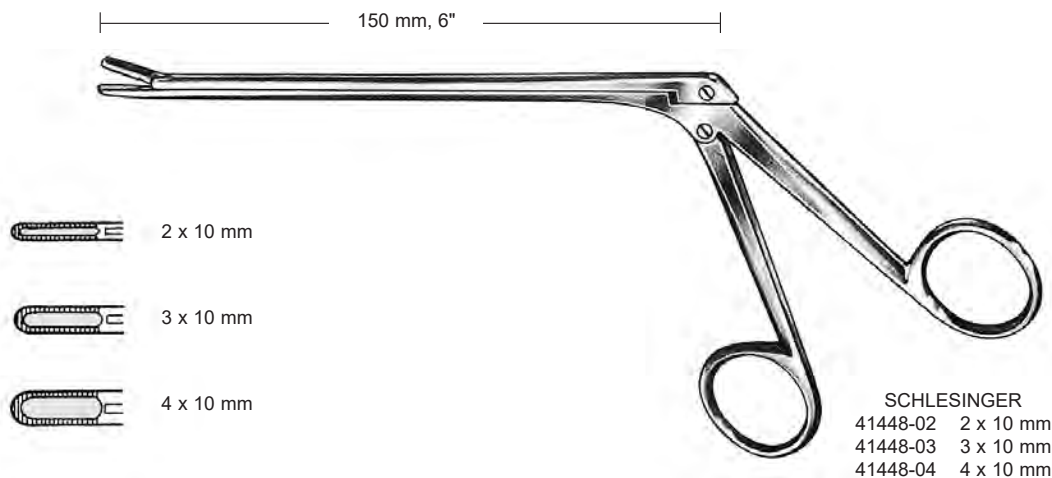


Laminektomie Zangen
 Laminectomy Rongeurs
 Pinzas cortantes para laminectomia
 Pinze taglienti per laminectomia

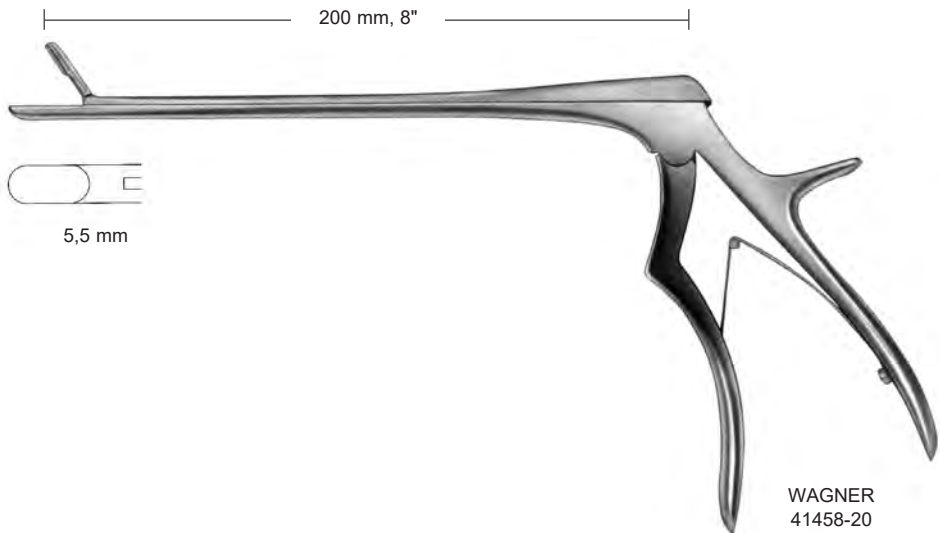
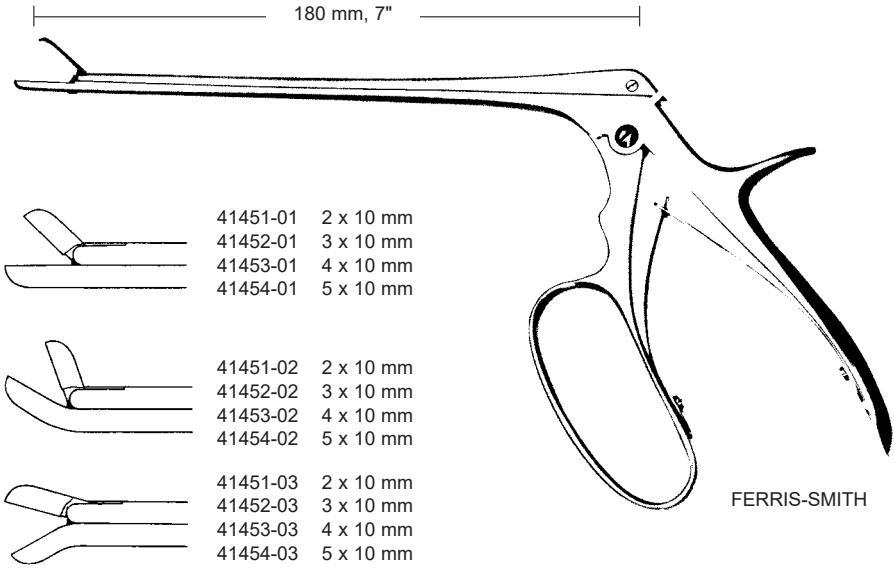




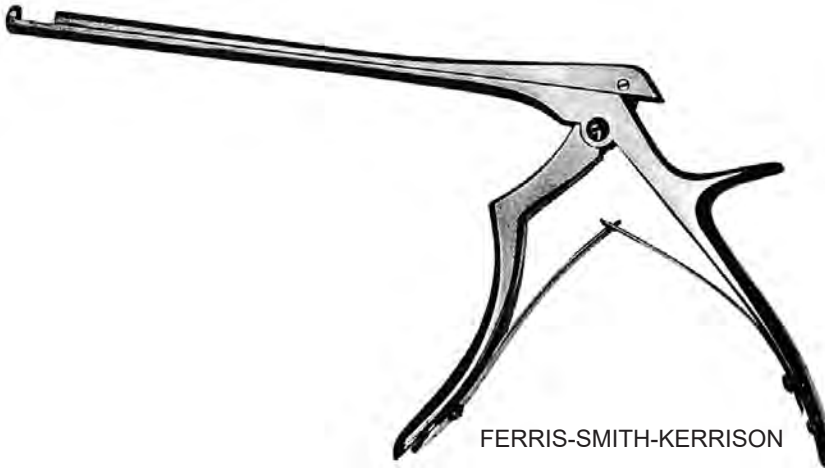
Laminektomie Zangen
 Laminectomy Rongeurs
 Pinzas cortantes para laminectomia
 Pinze taglienti per laminectomia



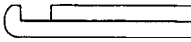
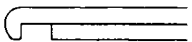
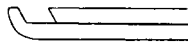
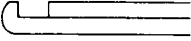
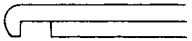
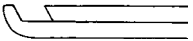
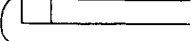
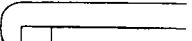
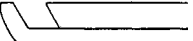
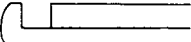
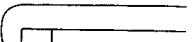
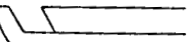
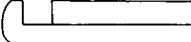
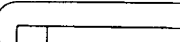
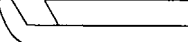
Laminektomie Zangen
 Laminectomy Rongeurs
 Pinzas cortantes para laminectomia
 Pinze taglianti per laminectomia



Bandscheibenstanzen
 Intervertebral Disc Rongeurs
 Pinzas sacabocado para discos intervertebrales
 Pinze taglianti per dischi intervertebrali

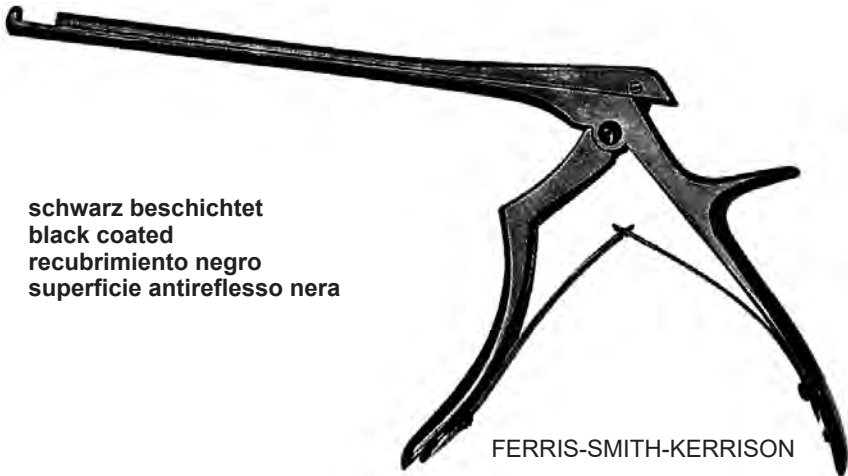


FERRIS-SMITH-KERRISON

	90°	90°	45°
			
18 cm, 7"	41510-01 1 mm	41511-01 1 mm	41512-01 1 mm
20 cm, 8"	41513-01 1 mm	41514-01 1 mm	41515-01 1 mm
23 cm, 9"	41513-01-23 1 mm	41514-01-23 1 mm	41515-01-23 1 mm
			
18 cm, 7"	41510-02 2 mm	41511-02 2 mm	41512-02 2 mm
20 cm, 8"	41513-02 2 mm	41514-02 2 mm	41515-02 2 mm
23 cm, 9"	41513-02-23 2 mm	41514-02-23 2 mm	41515-02-23 2 mm
			
18 cm, 7"	41510-03 3 mm	41511-03 3 mm	41512-03 3 mm
20 cm, 8"	41513-03 3 mm	41514-03 3 mm	41515-03 3 mm
23 cm, 9"	41513-03-23 3 mm	41514-03-23 3 mm	41515-03-23 3 mm
			
18 cm, 7"	41510-04 4 mm	41511-04 4 mm	41512-04 4 mm
20 cm, 8"	41513-04 4 mm	41514-04 4 mm	41515-04 4 mm
23 cm, 9"	41513-04-23 4 mm	41514-04-23 4 mm	41515-04-23 4 mm
			
18 cm, 7"	41510-05 5 mm	41511-05 5 mm	41512-05 5 mm
20 cm, 8"	41513-05 5 mm	41514-05 5 mm	41515-05 5 mm
23 cm, 9"	41513-05-23 5 mm	41514-05-23 5 mm	41515-05-23 5 mm

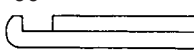
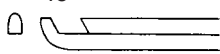
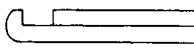
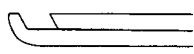
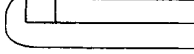
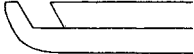
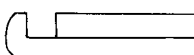
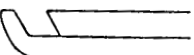
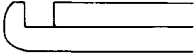
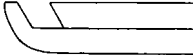
auch lieferbar mit Dünfuß und/oder mit Auswerfer
 also available with thin foot plate and/or with ejector
 tambien disponible con lámina de punzonar estrecha y/o con expulsor
 anche disponibile con morso sottile e/o con espulsore

Bandscheibenstanzen
Intervertebral Disc Rongeurs
Pinzas sacabocado para discos intervertebrales
Pinze taglianti per dischi intervertebrali



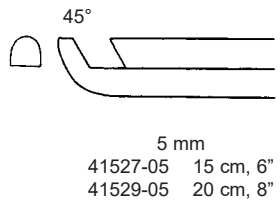
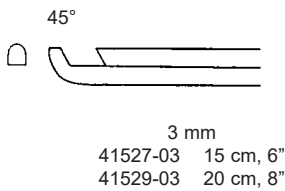
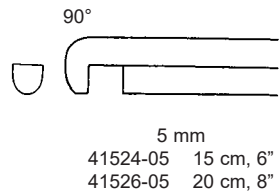
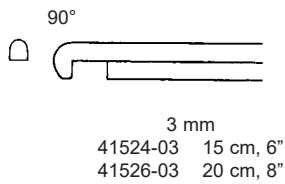
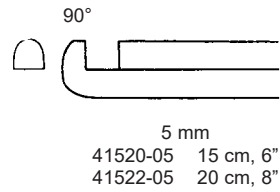
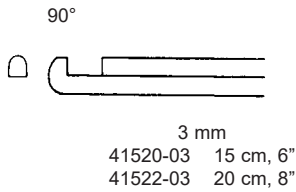
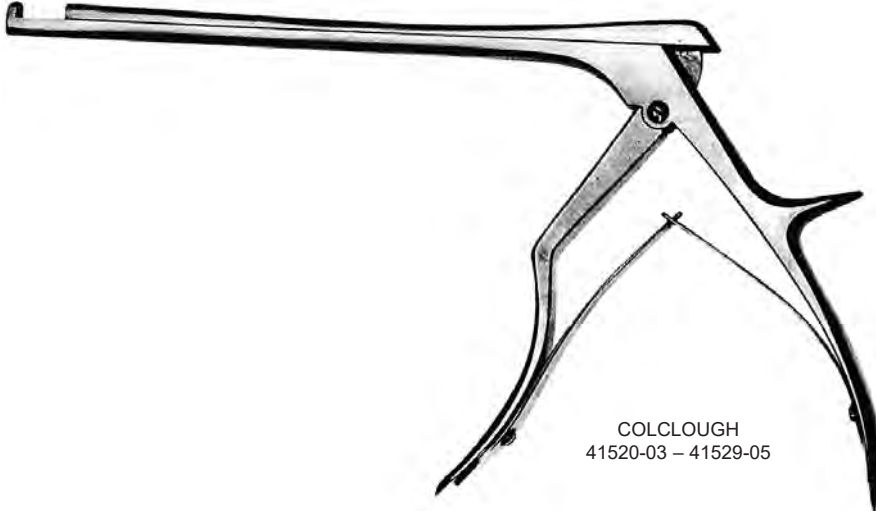
schwarz beschichtet
black coated
recubrimiento negro
superficie antireflesso nera

FERRIS-SMITH-KERRISON

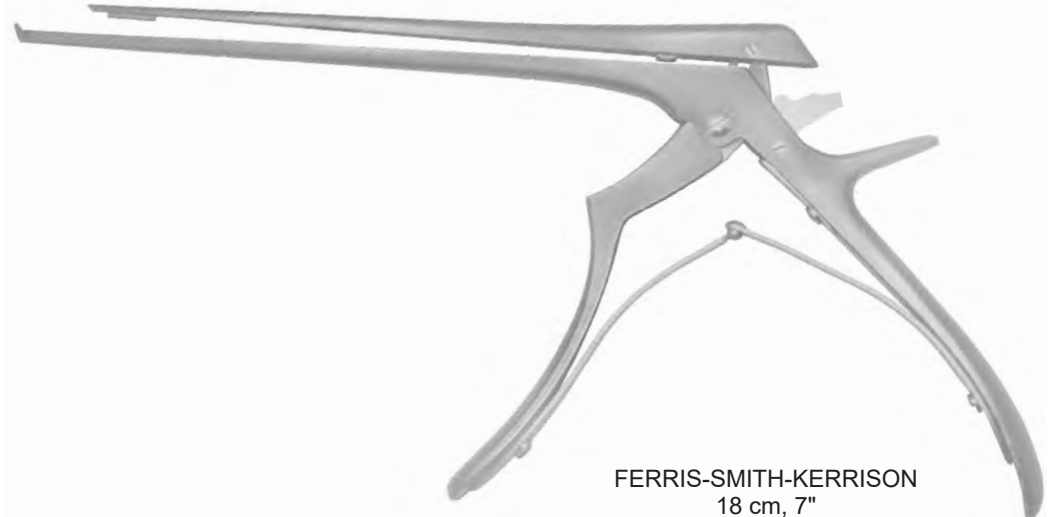
	90°		45°
			
18 cm, 7"	41510-01B 1 mm		41512-01B 1 mm
20 cm, 8"	41513-01B 1 mm		41515-01B 1 mm
23 cm, 9"	41513-01-23B 1 mm		41515-01-23B 1 mm
			
18 cm, 7"	41510-02B 2 mm		41512-02B 2 mm
20 cm, 8"	41513-02B 2 mm		41515-02B 2 mm
23 cm, 9"	41513-02-23B 2 mm		41515-02-23B 2 mm
			
18 cm, 7"	41510-03B 3 mm		41512-03B 3 mm
20 cm, 8"	41513-03B 3 mm		41515-03B 3 mm
23 cm, 9"	41513-03-23B 3 mm		41515-03-23B 3 mm
			
18 cm, 7"	41510-04B 4 mm		41512-04B 4 mm
20 cm, 8"	41513-04B 4 mm		41515-04B 4 mm
23 cm, 9"	41513-04-23B 4 mm		41515-04-23B 4 mm
			
18 cm, 7"	41510-05B 5 mm		41512-05B 5 mm
20 cm, 8"	41513-05B 5 mm		41515-05B 5 mm
23 cm, 9"	41513-05-23B 5 mm		41515-05-23B 5 mm

auch lieferbar mit Dünnpfuß und/oder mit Auswerfer
also available with thin foot plate and/or with ejector
tambien disponible con lámina de punzonar estrecha y/o con expulsor
anche disponibile con morso sottile e/o con espulsore

Bandscheibenstanzen
 Intervertebral Disc Rongeurs
 Pinzas sacabocado para discos intervertebrales
 Pinze taglianti per dischi intervertebrali

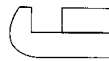


Zerlegbare Stanzen
Detachable punches
Pinzas cortantes desmontables
Pinze taglianti e smontabili



FERRIS-SMITH-KERRISON
18 cm, 7"

90°



130°



18 cm, 7"	41540-01	1 mm	41542-01	1 mm
20 cm, 8"	41544-01	1 mm	41543-01	1 mm
23 cm, 9"	41544-01-23	1 mm	41543-01-23	1 mm
18 cm, 7"	41540-02	2 mm	41542-02	2 mm
20 cm, 8"	41544-02	2 mm	41543-02	2 mm
23 cm, 9"	41544-02-23	2 mm	41543-02-23	2 mm
18 cm, 7"	41540-03	3 mm	41542-03	3 mm
20 cm, 8"	41544-03	3 mm	41543-03	3 mm
23 cm, 9"	41544-03-23	3 mm	41543-03-23	3 mm
18 cm, 7"	41540-04	4 mm	41542-04	4 mm
20 cm, 8"	41544-04	4 mm	41543-04	4 mm
23 cm, 9"	41544-04-23	4 mm	41543-04-23	4 mm
18 cm, 7"	41540-05	5 mm	41542-05	5 mm
20 cm, 8"	41544-05	5 mm	41543-05	5 mm
23 cm, 9"	41544-05-23	5 mm	41543-05-23	5 mm

auch lieferbar mit Dünnfuß und/oder mit Auswerfer
also available with thin foot plate and/or with ejector
tambien disponible con lámina de punzonar estrecha y/o con expulsor
anche disponibile con morso sottile e/o con espulsore

Bandscheibenstanzen, zerlegbar

Intervertebral Disc Rongeurs, dismantable

Pinzas sacabocado para discos intervertebrales, desmontab

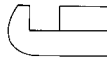
Pinze taglianti per dischi intervertebrali, smontabile a fucile



schwarz beschichtet
black coated
recubrimiento negro
superficie antireflesso nera

FERRIS-SMITH-KERRISON
18 cm, 7"

90°






130°



18 cm, 7"	41540-01B	1 mm	41542-01B	1 mm
20 cm, 8"	41544-01B	1 mm	41543-01B	1 mm
23 cm, 9"	41544-01-23B	1 mm	41543-01-23B	1 mm
18 cm, 7"	41540-02B	2 mm	41542-02B	2 mm
20 cm, 8"	41544-02B	2 mm	41543-02B	2 mm
23 cm, 9"	41544-02-23B	2 mm	41543-02-23B	2 mm
18 cm, 7"	41540-03B	3 mm	41542-03B	3 mm
20 cm, 8"	41544-03B	3 mm	41543-03B	3 mm
23 cm, 9"	41544-03-23B	3 mm	41543-03-23B	3 mm
18 cm, 7"	41540-04B	4 mm	41542-04B	4 mm
20 cm, 8"	41544-04B	4 mm	41543-04B	4 mm
23 cm, 9"	41544-04-23B	4 mm	41543-04-23B	4 mm
18 cm, 7"	41540-05B	5 mm	41542-05B	5 mm
20 cm, 8"	41544-05B	5 mm	41543-05B	5 mm
23 cm, 9"	41544-05-23B	5 mm	41543-05-23B	5 mm

auch lieferbar mit Dünnpfuß und/oder mit Auswerfer
also available with thin foot plate and/or with ejector
tambien disponible con lámina de punzonar estrecha y/o con expulsor
anche disponibile con morso sottile e/o con espulsore

Gefäßclips nach BIEMER
 BIEMER Vessel Clips
 Clips para vasos de BIEMER
 Clips per vasi secondo BIEMER

	Maulöffnung Opening	Maullänge Length of jaws	Schließkraft Closing Force
 41661-40	Apertura de la boca Apertura del morso 4,0 mm	Largo de la boca Lunghezza del morso 6,0 mm	Fuerza del cierre Forza di chiusura 30 - 40 g (0,29 - 0,39 N)
 41661-50	5,0 mm	9,0 mm	30 - 40 g (0,29 - 0,39 N)
 41662-50	5,0 mm	9,0 mm	20 - 25 g (0,20 - 0,25 N)

für temporären Gebrauch

gekennzeichnet durch gelb eingefärbte Federenden für Gefäße mit einem Durchmesser 0,5 - 2,0 mm

Maulinnenflächen schräg gerieft für schonendes, sicheres Festhalten der Gefäße

Der fest eingestellte Schließdruck gewährt risikofreie Anwendung

for temporary occlusion

(identified by yellow coloured spring ends) for vessel diam. 0,5 - 2,0 mm

Blade gripping surface with oblique serrations for save but careful gripping of vessels

No risk due to rigidly fixed pressure measure

para uso temporal

clips marcados con baño dorado en los resortes, para vasos con un diámetro de 0,5 - 2,0 mm

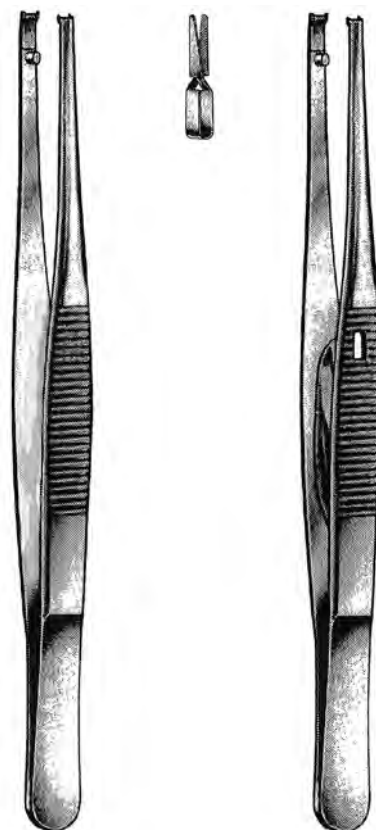
El interior de las quijadas viene con estrias finas para un agarre seguro y cuidadoso de los vasos

Debido a la calibración exacta de la fuerza de cierre se ofrece una aplicación sin riesgo

per chiusura temporanea

per vasi con Diametro 0,5 - 2,0 mm

La chiusura regolata garantisce nessun rischio



BIEMER
41663-01

Anlegepinzette ohne Schloß,
für Mikro-Gefäßclips
41661-40 - 41662-50
und
Approximatoren
41667-30 - 41670-50
und
41672-01 - 41672-04

Applying forceps without lock.
for vessel clips
41661-40 - 41662-50
and
Aproximators
41667-30 - 41670-50
and
41672-01 - 41672-04

BIEMER
41663-02

Anlegepinzette mit Schloß,
für Mikro-Gefäßclips
41661-40 - 41662-50
und
Approximatoren
41667-30 - 41670-50
und
41672-01 - 41672-04

Applying forceps with lock.
for vessel clips
41661-40 - 41662-50
and
Aproximators
41667-30 - 41670-50
and
41672-01 - 41672-04

Gefäßclips nach MEHDORN
MEHDORN Vessel Clips
Clips para vasos de MEHDORN
Clips secondo MEHDORN

für temporären Gebrauch

gekennzeichnet durch gelb eingefärbte Federenden für Gefäße mit einem Durchmesser 0,5 - 1,5 mm

Maulinnenflächen schräg gerieft für schonendes, sicheres Festhalten der Gefäße

Der fest eingestellte Schließdruck gewährt risikofreie Anwendung

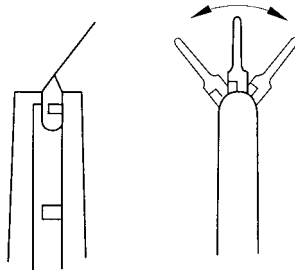
for temporary occlusion

(identified by yellow coloured spring ends) for vessel diam. 0,5 - 1,5 mm

Blade gripping surface with oblique serrations for safe but careful gripping of vessels

No risk due to rigidly fixed pressure measure

Beispiele für die variable Position des Clips
Ejemplo para la variedad de la aplicación del clip
Esempio: posizioni variabili delle clips



para uso temporal

clips marcados con baño dorado en los resortes, para vasos con un diámetro de 0,5 - 1,5 mm

El interior de las quijadas viene con estrias finas para un agarre seguro y cuidadoso de los vasos

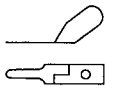
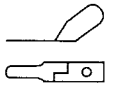
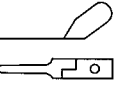

Debido a la calibración exacta de la fuerza de cierre se ofrece una aplicación sin riesgo

per chiusura temporanea

per vasi con Diametro 0,5 - 1,5 mm

La chiusura regolata garantisce nessun rischio



	Maullänge Length of jaws Largo de la boca Lunghezza del morso	Schließkraft Closing Force Fuerza del cierre Forza di chiusura	MEHDORN 41666-00
	41664-10 4 x 1,0 mm	10 - 15 g (0,10 - 0,15 N)	Anlegepinzette für Mikro-Gefäßclips 41664-10 - 41665-14
	41664-14 4 x 1,4 mm	15 - 20 g (0,15 - 0,20 N)	Applying Forceps for vessel clips 41664-10 - 41665-14
	41665-10 6 x 1,0 mm	10 - 15 g (0,10 - 0,15 N)	Pinza de aplicación para micro-clips 41664-10 - 41665-14
	41665-14 6 x 1,4 mm	15 - 20 g (0,15 - 0,20 N)	Pinza posa clips per microvasi 41664-10 - 41665-14

Approximatoren nach Biemer-Müller
 Approximators Biemer-Müller
 Aproximadores de Biemer-Müller
 Approssimatore secondo Biemer-Müller

für temporären Gebrauch

gekennzeichnet durch gelb eingefärbte Federenden für Gefäße mit einem Durchmesser 0,5 - 2,0 mm
 Maulinnenflächen schräg gerieft für schonendes, sicheres Festhalten der Gefäße
 Der fest eingestellte Schließdruck gewährt risikofreie Anwendung

for temporary occlusion

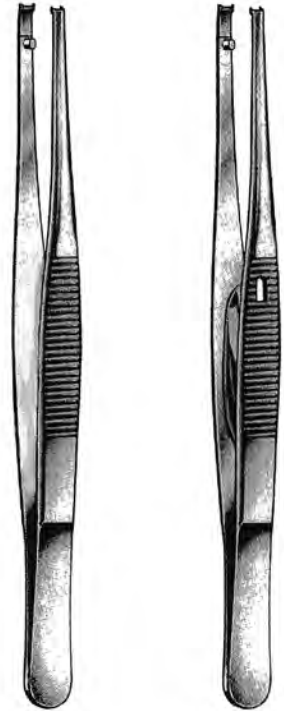
(identified by yellow coloured spring ends) for vessel diam. 0,5 - 2,0 mm
 Blade gripping surface with oblique serrations for save but careful gripping of vessels
 No risk due to rigidly fixed pressure measure

para uso temporal

clips marcados con baño dorado en los resortes, para vasos con un diámetro de 0,5 - 2,0 mm
 El interior de las quijadas viene con estrias finas para un agarre seguro y cuidadoso de los vasos
 Debido a la calibración exacta de la fuerza de cierre se ofrece una aplicación sin riesgo

per chiusura temporanea

per vasi con Diametro 0,5 - 2,0 mm
 La chiusura regolata garantisce nessun rischio



	Maulöffnung Opening	Maullänge Length of jaws	Schließkraft Closing Force
	Apertura de la boca	Largo de la boca	Fuerza del cierre
	Apertura del morso	Lunghezza del morso	Forza di chiusura
	3,0 mm	4,5 mm	30 - 40 g (0,29 - 0,39 N)
	5,0 mm	9,0 mm	30 - 40 g (0,29 - 0,39 N)
	5,0 mm	9,0 mm	30 - 40 g (0,20 - 0,25 N)
	5,0 mm	9,0 mm	30 - 40 g (0,20 - 0,25 N)
	5,0 mm	9,0 mm	30 - 40 g (0,20 - 0,25 N)

41670-50

BIEMER
41663-01

BIEMER
41663-02

Anlegepinzette ohne
Schloß,
für Mikro-Gefäßclips
41661-40 - 41662-50
und
Approximatoren
41667-30 - 41670-50
und
41672-01 - 41672-04

Anlegepinzette mit
Schloß,
für Mikro-Gefäßclips
41661-40 - 41662-50
und
Approximatoren
41667-30 - 41670-50
und
41672-01 - 41672-04

Applying forceps without
lock.
for vessel clips
41661-40 - 41662-50
and
Aproximadores
41667-30 - 41670-50
and
41672-01 - 41672-04

Applying forceps with
lock.
for vessel clips
41661-40 - 41662-50
and
Aproximadores
41667-30 - 41670-50
and
41672-01 - 41672-04

LEYLA Retraktor System
 LEYLA Retractor System
 Separador de sistema LEYLA
 LEYLA Sistema di fissaggio



YASARGIL

- 41801-01 Hirnspatelhalter, flexibel, für 1 flachen Spatel, komplett, bestehend aus:
 brain retractor, flexible, for 1 flat spatula, complete, consisting of:
 separador autorententivo, flexible, para espátula con 1 brazo flexible, completo, compuesto de:
 divaricatore autostatico, flessibile, per spatole piatte, con 1 braccio flessibile, completo, composto da:
- 41810-10 flexibler Spannarm
 flexible arm
 brazo flexible
 braccio flessibile
- 41826-26 Fixiervorrichtung für 1 flexiblen Spannarm
 fixation base for 1 flexible arm
 fijador para 1 brazo flexible
 fissatore per 1 braccio al braccio rigido
- 41830-30 Spatelhalter für flache Spatel
 support for flat brain spatula
 soporte para espátulas cerebrales planas
 sostegno per spatole piatte



YASARGIL

- 41802-02 Hirnspatelhalter, flexibel für 2 flache Spatel, komplett, bestehend aus:
 brain retractor, flexible, for 2 flat spatulas, complete, consisting of:
 separador autorententivo, flexible, para 2 espátulas planas con 2 brazos flexibles, completo, compuesto de:
 divaricatore autostatico, flessibile, per spatole piatte, con 2 bracci flessibili, completo, composto da:
- 41810-10 flexibler Spannarm (2x)
 flexible arm (2x)
 brazo flexible (2x)
 braccio flessibile (2x)
- 41822-22 Fixiervorrichtung für 2 flexible Spannarme
 fixation base for 2 flexible arms
 fijador para 2 brazos
 fissatore per 2 bracci al cranio
- 41830-30 Spatelhalter für flache Spatel (2x)
 support for flat brain spatula (2x)
 soporte para espátulas cerebrales planas (2x)
 sostegno per spatole piatte (2x)

LEYLA Retractor System
 LEYLA Retractor System
 Separador de sistema LEYLA
 LEYLA Sistema di fissaggio

41821-21

Fixiervorrichtung für 1 flexiblen Spannarm zum Festschrauben an Rohrteilen bis
 ø 16 mm

Fixation base for mounting on bars up to ø16 mm, for 1 flexible arm

Fijador para 1 brazo flexible, para atornillar a tubos hasta 16 mm

Fissatore per 1 braccio al braccio rigido



41822-22

Fixiervorrichtung für 2 flexible Spannarme zum Festschrauben am Schädel

Fixation base for skull mounting, holding 2 flexible arms

Fijador para 2 brazos flexibles, para atornillar al cráneo

Fissatore per 2 bracci al cranio



41826-26

Fixiervorrichtung für 1 flexiblen Spannarm zum Festschrauben am Schädel

Fixation base for skull mounting, holding 1 flexible arm

Fijador para 1 brazos flexibles, para atornillar al cráneo

Fissatore per 1 braccio al cranio



41830-30

Spatelhalter für flache Hirnspatula zur Befestigung am Spannarm

Support for flat brain spatula

Soporte para espátulas cerebrales planas para fijación al brazo flexible

Sostegno per spatole piatte



41832-32

Halter für Hirnspatula mit rundem Schaft bis ø 5,5 mm zur Befestigung am Spannarm

Support for brain spatula with round shaft

Soporte para espátulas cerebrales con mango redondo hasta ø 5,5 mm para fijación al brazo flexible

Sostegno flessibile per spatola cerebrale

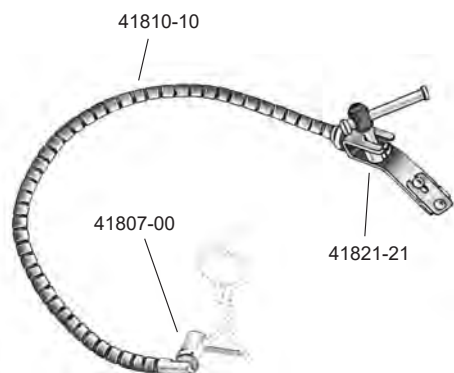


LEYLA Retraktor System
 LEYLA Retractor System
 Separador de sistema LEYLA
 LEYLA Sistema di fissaggio



YASARGIL

41810-10 flexibler Spannarm, allein
 flexible arm, only
 brazo flexible, suelto
 braccio flessibile, solo



YASARGIL

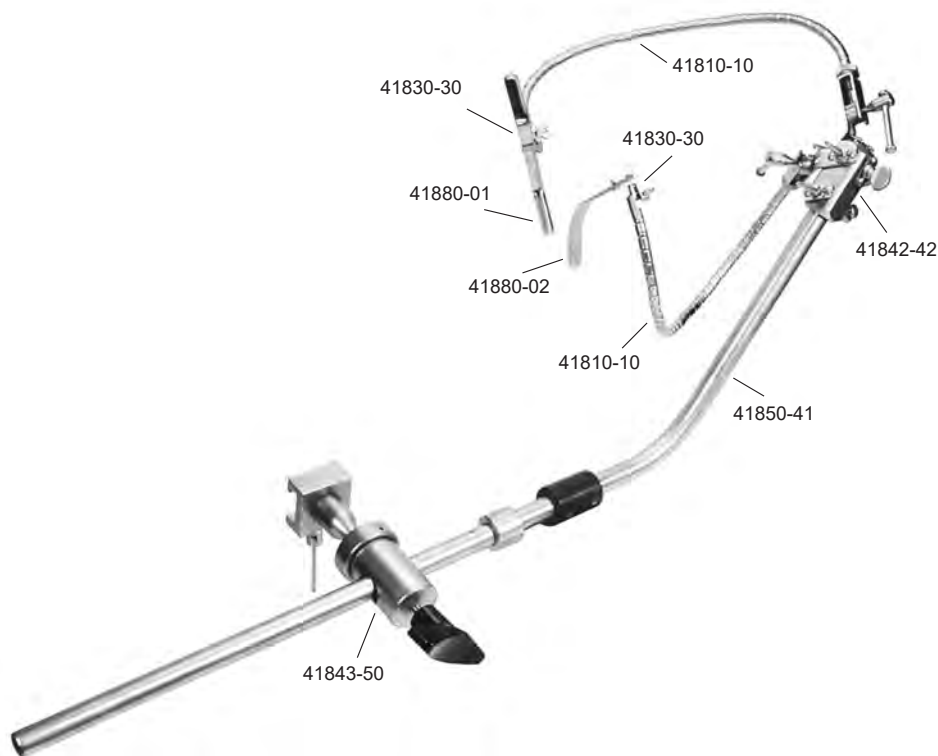
41803-01 Ohrspekulahalter, komplett, bestehend aus:
 ear specula holder, complete, consisting of:
 soporte para espejos auriculares completo,
 compuesto de:
 sostegno per specchio auricolare, completo
 composto da:

41810-10 flexibler Spannarm
 flexible arm, only
 brazo flexible, suelto
 braccio flessibile, solo

41821-21 Fixiervorrichtung zum Befestigen an Rohrteilen
 bis Ø 16 mm
 clamp for fixation on bars up to Ø 16 mm
 fijador para 1 brazo flexible, para atornillar a
 tubos hasta 16 mm
 fissatore al braccio rigido Ø 16 mm

41807-00 Ohrtrichterhalter, allein
 ear specula holder, only
 soporte para espejos auriculares, suelto
 sostegno per specchio auricolare

LEYLA Retraktor System
 LEYLA Retractor System
 Separador de sistema LEYLA
 LEYLA Sistema di fissaggio



41802-00 LEYLA-Retraktor-System zum Fixieren am OP-Tisch komplett, bestehend aus:
 LEYLA Self-Retraining Retractor for fixation to operating table, complete, consisting of:
 Separador LEYLA para fijacion a la mesa de operaciones, completo, compuesto de:
 LEYLA Sistema di fissaggio al tavolo operatorio, composto da:

41843-50 Kugelgelenkkloben (1x) ball and socket joint (1x) articulacion esferica (1x) giunto per fissare (1x)	41830-30 Spatelhalter für flache Spatel (2x) support for flat brain spatula (2x) soporte para espátulas cerebrales planas (2x) sostegno per spatole piatte (2x)
41850-41 starrer Haltearm (1x) rigid holding rod (1x) brazo de fijación rigido (1x) braccio di fissaggio rigido (1x)	41880-01 CUSHING Hirnspatel (1x) CUSHING brain spatula (1x) CUSHING espátula para cerebro (1x) CUSHING spatola cerebrale (1x)
41842-42 Kupplungskopf (1x) coupling head (1x) cabeza de acoplamiento (1x) giunto per combinare (1x)	41880-02 CUSHING Hirnspatel (1x) CUSHING brain spatula (1x) CUSHING espátula para cerebro (1x) CUSHING spatola cerebrale (1x)
41810-10 flexibler Spannarm (2x) flexible arm, only (2x) brazo flexible, suelto (2x) braccio flessibile, solo (2x)	

LEYLA Retraktor System
 LEYLA Retractor System
 Separador de sistema LEYLA
 LEYLA Sistema di fissaggio



- 41843-50 Kugelgelenkkloben
 zum Befestigen an der OP-Tischschiene
 und zur Aufnahme des Haltearms
 41850-41
-
- ball and socket joint
 for fixation of holding rod 41850-41 at the
 operating table
-
- articulacion esferica, para sujetar el brazo
 de soporte rigido sobre la mesa de
 operaciones 9 x 32 mm
-
- giunto per fissare il braccio,
 articolato 9 x 32 mm



- 41850-41 starrer Haltearm, auseinandernehmbar, zur Fixation im
 Kugelgelenkkloben 41843-50 und zur wahlweisen
 Aufnahme der Kupplungsköpfe 41842-42, 41842-44 und
 41842-46
-
- holding rod, detachable, for fixation in ball and socket joint
 41843-50 and to hold a desired coupling head
 41842-42, 41842-44 or 41842-46
-
- brazo de soporte rigido, desmontable, para fijacion a la
 articulacion esferica 41843-50 y opcionalmente a las
 cabezas 41842-42, 41842-44 y 41842-46
-
- braccio di sostegno rigido, per fissaggio al giunto
 41843-50 e dei giunti 41842-42, 41842-44 e 41842-46



- 41842-42 Kupplungskopf, zur Aufnahme von max.
 5 flexiblen Spannarmen 41810-10
-
- coupling head to hold 5 flexible arms
 41810-10
-
- cabeza de acoplamiento para fijar hasta
 5 brazos flexibles
-
- giunto per combinare 5 bracci



- 41842-44 Kupplungskopf, drehbar, zur Aufnahme von 1 flexiblen Spannarm
 41810-10
-
- coupling head, turnable, to hold 1 flexible arm 41810-10
-
- acoplamiento, girable y se puede fijar en todas las
 posturas para sujetar un brazo flexible 41810-10
-
- giunto per combinare, rotabile, per sostegno del braccio 41810-10

Hirnspatel
Brain Spatulas
Espátula Cerebral
Spatole Cerebrali



HEIFETZ
200 mm
8"



biegsam
malleable
maleable
malleabili

	Breite width ancho larghezza	Gesamtlänge total length largo total lunghezza totale
41860-14	14 mm	200 mm
41860-17	17 mm	200 mm
41860-20	20 mm	200 mm

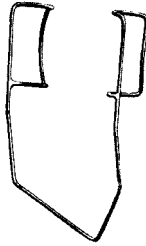


biegsam
malleable
maleable
malleabili

	Breite width ancho larghezza	Gesamtlänge total length largo total lunghezza totale
41880-01	9 mm	200 mm
41880-02	12 mm	200 mm
41880-03	12 mm	250 mm

CUSHING
200 mm, 8"

Lidsperrer
Eye Specula
Blefaróstatos
Blefarostati

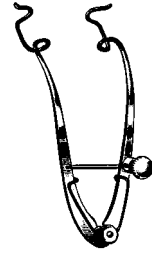


BARRAQUER (Colibri)

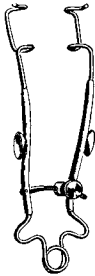
43101-03 3 cm, 1.2" für Kinder / children / niños / bambini
43101-04 4 cm, 1.6" für Erwachsene / adults / adultos / adulti



BOWMAN
43104-07
7 cm, 2 3/4"



CLARK
43107-08
8 cm, 3 1/8"



GRAEFE

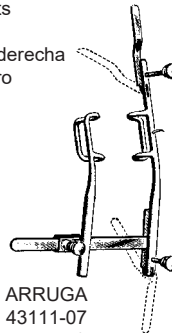
43109-07 7 cm, 2 3/4"
43109-09 9 cm, 3 1/2"



WEEK

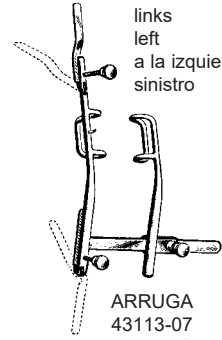
43110-08
8 cm, 3 1/8"

rechts
right
a la derecha
destro

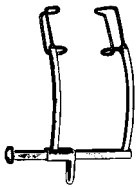


ARRUGA
43111-07
7 cm, 2 3/4"

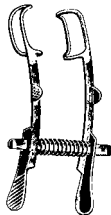
links
left
a la izquierda
sinistro



ARRUGA
43113-07
7 cm, 2 3/4"



MURDOCK
43115-05
5 cm, 2"



MELLINGER

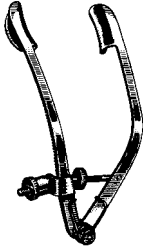
43125-05 5 cm, 2"
43125-07 7 cm, 2 3/4"



WILLIAMS

43128-08
8 cm, 3 1/8"

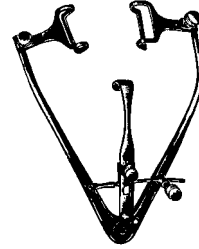
Lidsperrer, Lidplatte, Starmesser
 Eye Specula, Lid Plate, Cataract Knives
 Blefaróstatos, Placa para párpados, cuchillos para cataratas
 Blefarostati, Placca per palpebre, coltelli per cataratta



LANCASTER
 43129-07
 7 cm, 2 3/4"



CASTROVIEJO
 43132-08
 8 cm, 3 1/8"



PARK
 43133-08
 8 cm, 3 1/8"



MUELLER
 43135-07
 7 cm, 2 3/4"



STEVENSON
 43139-07
 7 cm, 2 3/4"



LIEBERMAN
 43140-08
 8 cm 3 1/8"



LIEBERMAN
 43141-08
 8 cm 3 1/8"



JAEGER
 43150-11
 11 cm, 4 3/8"



GRAEFE
 43170-00 - 43170-03
 13 cm, 5 1/8"



43170-00



43170-01



43170-02

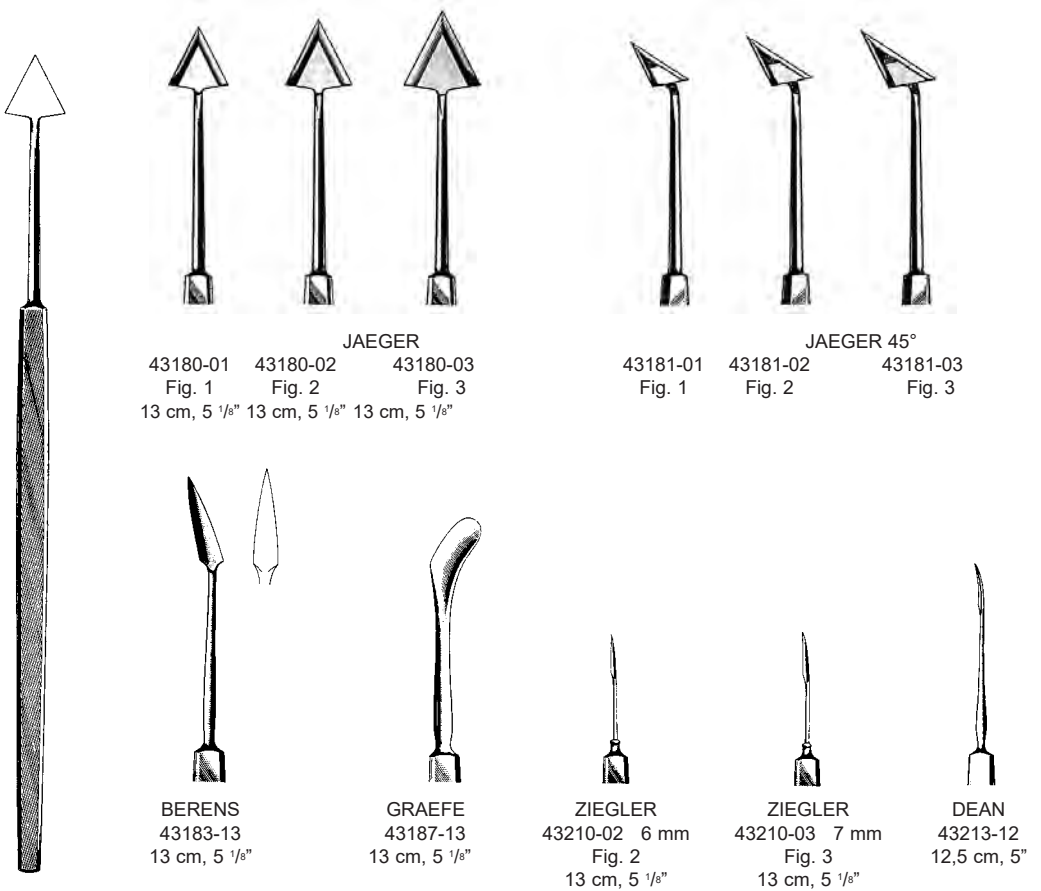


43170-03



DEUTSCHMANN
 43172-13
 13 cm, 5 1/8"

Lanzenmesser, Diszisionsmesser, Irismesser, Diszisionsmesser
 Cataract knife, keratome, Iris knife, discision knife
 Cuchillos lanceolares y Cuchillos de discisión
 Cheratome, bisturi p. capsule, bisturi corneale



43180-01 - 43181-03

Hornhautmesser, Hornhautschaber, Dissektor, Sklerotom, Goniotomiemesser
 Corneal Scarifier, -dissector, sclerotome, goniotomy knife
 Cuchillos para cornea, legtras corneales, esclerótomos
 Spatole p. corneale, dissettoe corneale, sclerotomo, coltello per goniotomia



WHEELER
 43218-12
 12 cm, 4 3/4"



ZIEGLER
 43221-11
 11 cm, 4 3/8"
 3,5 mm



TOOK
 43228-12
 12 cm, 4 3/4"



GILL
 43231-12
 12 cm, 4 3/4"



PATON
 43245-12
 12 cm, 4 3/4"



LUNDSGAARD
 43251-12
 12 cm, 4 3/4"



GUYTON-
 LUNDSGAARD
 43253-12



SCHEIE
 43258-12



BURCH
 43262-12



PAUFIQUE
 43271-11



BARRAQUER
 43273-13

Diszisionsnadeln, Fremdkörpernadeln, Fremdkörperhohlmeißel
 Discision Needles, Foreign-Body Instruments
 Agujas de discisión, Instrumental para cuerpos extraños
 Aghi per discisione, strumenti per corpi estranei



43304-12



43305-12

BOWMAN
43308-12BOWMAN
43309-12

43310-13



43311-13

FRANCIS
43321-12LA FORCE
43327-12DIX
43330-13WALTON
43334-12
1,4 mmALVIS
43336-12GREEN
43340-13ROLLET
43342-12

Schielhaken, Tenotomiehaken, Extraktionshaken, Tränensackhäkchen
 Strabismus hook, lens hook, extraction hook
 Ganchos para estrabismo, - cristalino, extracción
 Uncino per il strabismo, uncino p. cristallino, protettori, uncini per l'iride



Fig. 1
 GRAEFE
 43351-01
 13 cm, 5 1/8"



Fig. 2
 GRAEFE
 43351-02
 14 cm, 5 1/2"



Fig. 3
 GRAEFE
 43351-03
 15 cm, 6"



JAMESON
 43353-13



GREEN
 43355-13



STEVENS
 43357-13



O'CONNOR
 43370-12



WIENER
 43372-13



WIENER
 43373-13



ROLLET
 43376-13



KNAPP
 43377-13

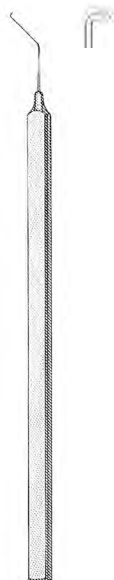


GRAEFE
 43380-13



BECKER
 43386-13

Haken
hooks
ganchos
ganci



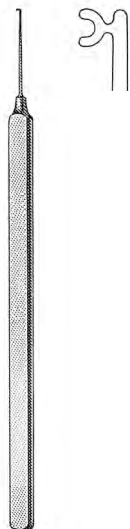
CLAYMAN
43387-02
11,5 cm 4 1/2"



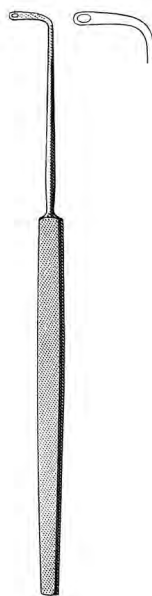
SINSKEY
43388-02
11,4 cm 4 1/2"



SINSKEY
43389-02
12 cm 4 3/4"

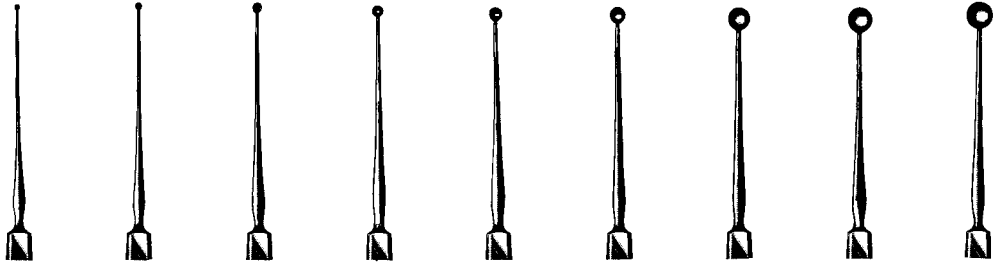


KUGLEN
43390-05
11,7 cm 4 5/8"



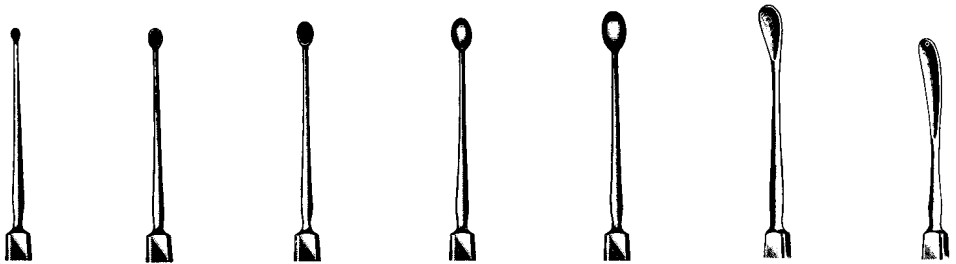
GASS
43391-13
14,6 cm 5 3/4"

Küretten und Löffel für Chalazion und Star
 Scoops and Curettes for Chalazio, Cataract, and Exenteration
 Curetas y cucharillas para chalazión, catarata y exenteración
 Curette e cucchiari per calazio, cateratta e palpebre



MEYHOEFER

	43402-05	43402-10	43402-15	43402-18	43402-20	43402-25	43402-35	43402-40	43402-45
Ø mm	0,5	1,0	1,5	1,8	2,0	2,5	3,5	4,0	4,5



	HEBRA 43404-10	HEBRA 43404-20	HEBRA 43404-24	HEBRA 43404-30	HEBRA 43404-35	GRAEFE 43410-02	DAVIEL 43412-02
Ø mm	1,0	2,0	2,5	3,0	3,5		4 mm

Starlöffel, Exenterationslöffel, Drahtschlingen, Starschlingen, Irisspatel, Enukleationslöffel, Wundlöffel
 Cataract Spoon, Exenteration Scoops, Lens Scoops, Spatulas, Protectores
 Cucharillas para Catarata-, exenteraciòn, Asas, Espátulas, Protectores
 Cucchiaio per cateratta- esenterazione, Anse, Spatole, Protettori



KNAPP
43414-02



BUNGE
43420-01



BUNGE
43420-02



BUNGE
43420-03



LANG
43424-13



WEBER
43441-01
Fig. 1



43441-02
Fig. 2



SNELLEN
43443-13



WILDER
43445-13
Fig. 1



43447-13
Fig. 2

Iris
Iride



WECKER
43461-13



WECKER
43462-13



WELLS
43482-20

Cautery
Cauter
Cauterio



WADSWORTH-TODD
43487-14

Zyklodialysespatel, Fremdkörperinstrumente
 Cyclodialysis Spatula, Foreign Body Instruments
 Espátulas para ciclodiálisis, Instrumentos para cuerpos extraños
 Spatole per ciclodialisi, Strumenti per corpi estranei



43511-13 - 43517-09



CASTROVIEJO
 43511-13
 1,2 x 10 mm



CASTROVIEJO
 43513-14
 1,5 x 15 mm



ELSCHNIG
 43515-14
 1,2 x 12 mm



CASTROVIEJO
 43517-09
 0,8 x 15 mm

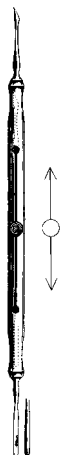


HIRSCHMAN
 43524-10
 12,5 cm, 5"



CASTROVIEJO
 43525-05 0,50 mm
 43525-07 0,75 mm

Fremdkörperinstrumente
 Foreign- Body Instruments
 Instrumental para cuerpos extraños
 Strumenti per corpi estranei



DIX
43542-12



DIX
43544-12



DIX
43546-13



DIX
43548-13



CASTROVIEJO
43583-07 0-20 mm
9 cm, 3 1/2"

Tränenkanaldilatatoren, Sonden
 Lachrymal Dilators-, Probes
 Diladores, Estiletos para canal lacrimal
 Dilatori e Specilli per canale lacrimale



WILDER
43602-01



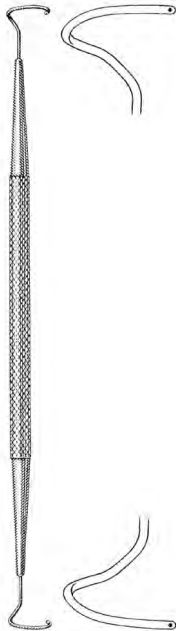
WILDER
43602-02



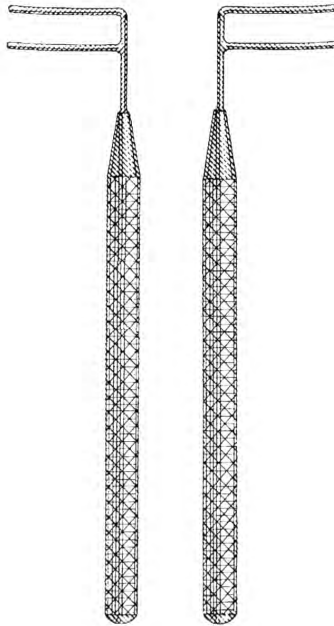
WILDER
43602-03



CASTROVIEJO
43608-12



WORST
43609-14
14,9 cm 5 7/8"



HARMS
43610-01 43610-02
4,8 cm 1 7/8"



geknöpft
buttoned
abotonado
abbottonato



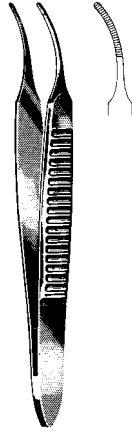
rostfrei
stainless steel
acero inoxidable
acciaio inossidabile

Fig.	BOWMAN	Ø mm
0000/000	43613-00	0,6/0,7
00/0	43614-00	0,7/0,8
0/1	43614-01	0,8/0,9
1/2	43614-12	0,9/1,1
2/3	43614-23	1,1/1,3
3/4	43614-34	1,3/1,4
4/5	43614-45	1,4/1,5
5/6	43614-56	1,5/1,6
6/7	43614-67	1,6/1,8
7/8	43614-78	1,8/1,9

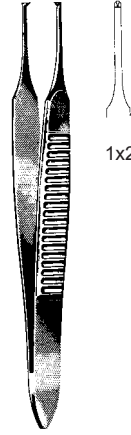
Iris Pinzetten
Iris Forceps
Pinzas para iris
Pinze per iride



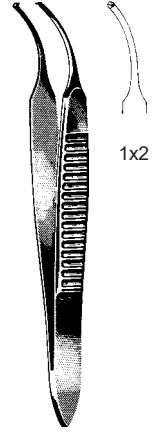
GRAEFE
43802-07
7 cm (2 3/4")/1 mm



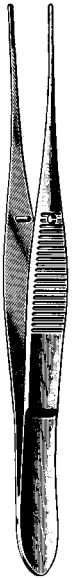
GRAEFE
43803-07
7 cm (2 3/4")/1 mm



GRAEFE
43804-07
7 cm (2 3/4")/1 mm



GRAEFE
43805-07
7 cm (2 3/4")/1 mm



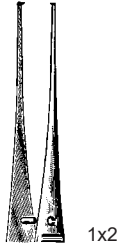
GRAEFE
43810-10
10 cm
4"



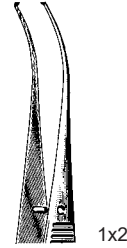
GRAEFE
43811-10
10 cm
4"



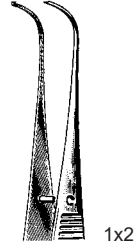
GRAEFE
43813-10
10 cm
4"



GRAEFE
43820-10
10 cm
4"



GRAEFE
43821-10
10 cm
4"



GRAEFE
43823-10
10 cm
4"

Iris Pinzetten
Iris Forceps
Pinzas para iris
Pinze per iride



STEVENS
43830-10
10,5 cm, 4.1"



STEVENS
43831-10
10,5 cm
4.1"



STEVENS
43833-10
10,5 cm
4.1"



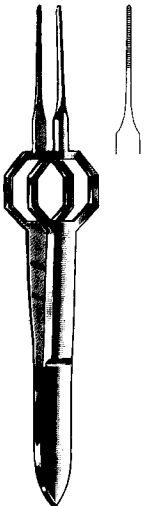
STEVENS
43840-10
10,5 cm
4.1"



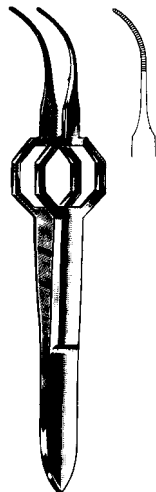
STEVENS
43841-10
10,5 cm
4.1"



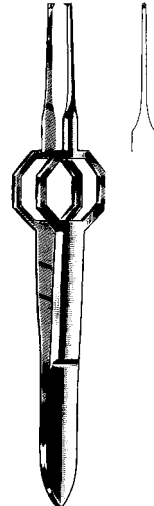
STEVENS
43843-10
10,5 cm
4.1"



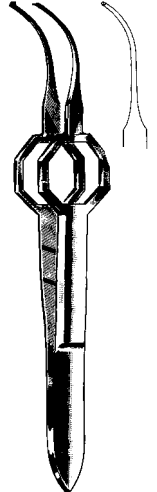
FOERSTER
43850-08
8,5 cm, 3.4"



FOERSTER
43851-08
8,5 cm, 3.4"



FOERSTER
43852-08
8,5 cm, 3.4"

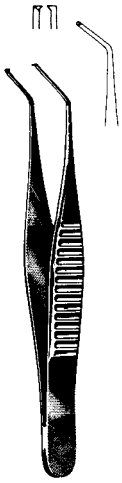


FOERSTER
43853-08
8,5 cm, 3.4"

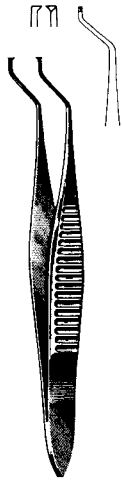
Iris Pinzetten
Iris Forceps
Pinzas para iris
Pinze per iride

seitliche Zähne
lateral teeth
dientes laterales
denti laterali

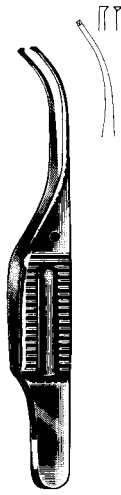
Zähne abwärts
teeth below
dientes abajo
denti in basso



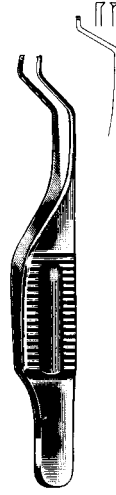
HESS
43855-07
7 cm (2 3/4")/
0,3 mm



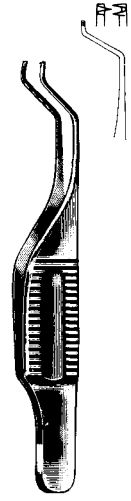
HESS
43857-07
7 cm (2 3/4")/
0,3 mm



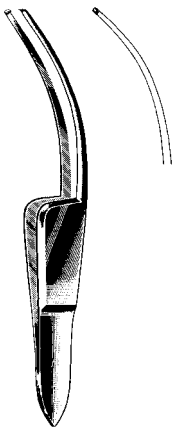
GILL
43861-07
7,5 cm (3")/
0,3 mm



GILL-HESS
43863-07
7,5 cm (3")/
0,3 mm



GILL-HESS
43865-07
7,5 cm (3")/
0,3 mm



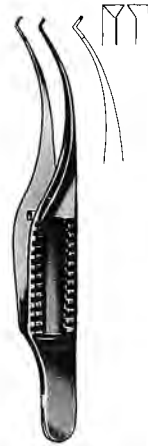
FISCHER
43869-07
7 cm (2 3/4")



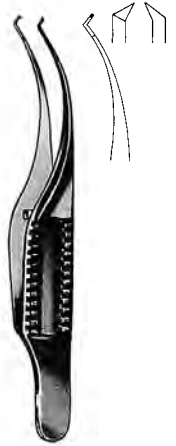
BARRAQUER-KATZIN
43881-07
7 cm (2 3/4")/0,4 mm



TROUTMAN (Colibri)
43883-07
7 cm (2 3/4")/0,12 mm



BARRAQUER (Colibri)
43885-07
7 cm (2 3/4")/0,12 mm



BARRAQUER (Colibri)
43887-07
7 cm (2 3/4")/0,12 mm

Fixierpinzette, Strabismus-Pinzetten
 Fixation forceps, Strabismus-Forceps
 Pinza para fijación, Pinzas para estrabismo
 Pinza per fissatrice, Pinze per strabismo

1x2



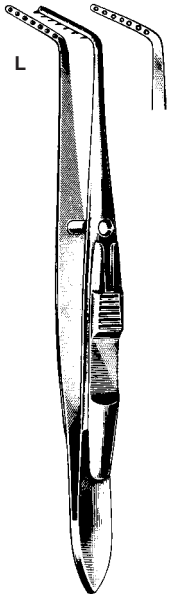
KIRBY-ARTHUR
 43891-09 9 cm, 3 1/2"
 0,2 mm



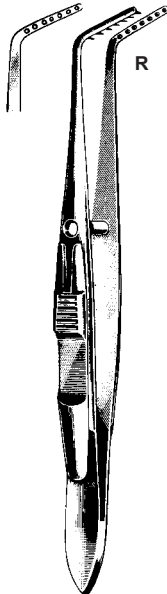
McCULLOUGH
 43902-09
 9,5 cm, 3 3/4"



McCULLOUGH
 43903-09
 9,5 cm, 3 3/4"



JAMESON
 43907-10
 10 cm, 4"



JAMESON
 43909-10
 10 cm, 4"



BONACCOLTO
 43914-10
 10 cm, 4 1/1,7 mm

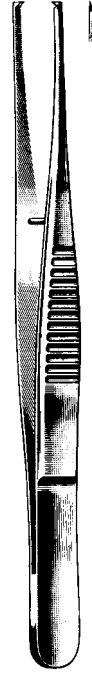


BONACCOLTO
 43916-10
 10 cm, 4 1/1,2 mm

Strabismus-Pinzetten, Iris-Pinzetten
 Strabismus-Forceps, Iris Forceps
 Pinzas para estrabismo, Pinzas para iris
 Pinze per strabismo, Pinze per iride



DASTOOR
 43924-11
 11 cm, 4 $\frac{3}{8}$ "



DASTOOR
 43926-11
 11 cm, 4 $\frac{3}{8}$ "



BISHOP-HARMAN
 43940-05 8,5 cm, 3.4"
 0,5 mm



BISHOP-HARMAN
 43940-08 8,5 cm, 3.4"
 0,8 mm



BISHOP-HARMAN
 43942-05 8,5 cm, 3.4"
 0,5 mm

1x2



BISHOP-HARMAN
 43942-08 8,5 cm, 3.4"
 0,8 mm

1x2

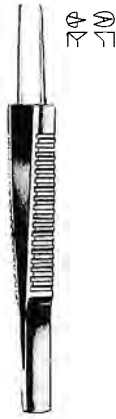
Iris Pinzetten, Nahtpinzetten, Muskelpinzetten
 Iris, Suture forceps, Muscle Forceps
 Pinzas para iris, Pinza para sutura, Pinzas musculares
 Pinze per iride, Pinza per sutura, muscolari

mit Führungsstift
 with guide pin
 con perno guida
 con perno di guida

ohne Führungsstift
 without guide pin
 sin perno guida
 senza perno di guida



MOD. BONN
 43944-07
 7 cm, 2 3/4"
 0,12 mm



MOD. BONN
 43946-07
 7 cm, 2 3/4"
 0,12 mm



MOD. BONN
 43948-10
 10 cm, 4"
 0,12 mm



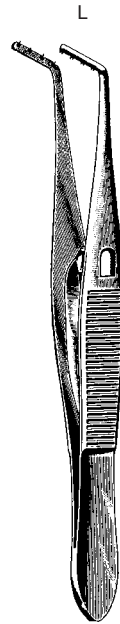
MOD. TÜBINGEN
 43950-10
 10 cm, 4"



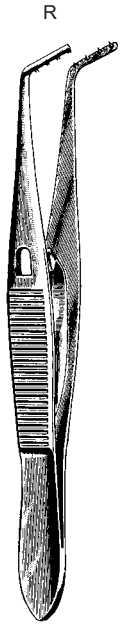
MOD. BONN
 43952-10
 10 cm, 4"/0,12 mm



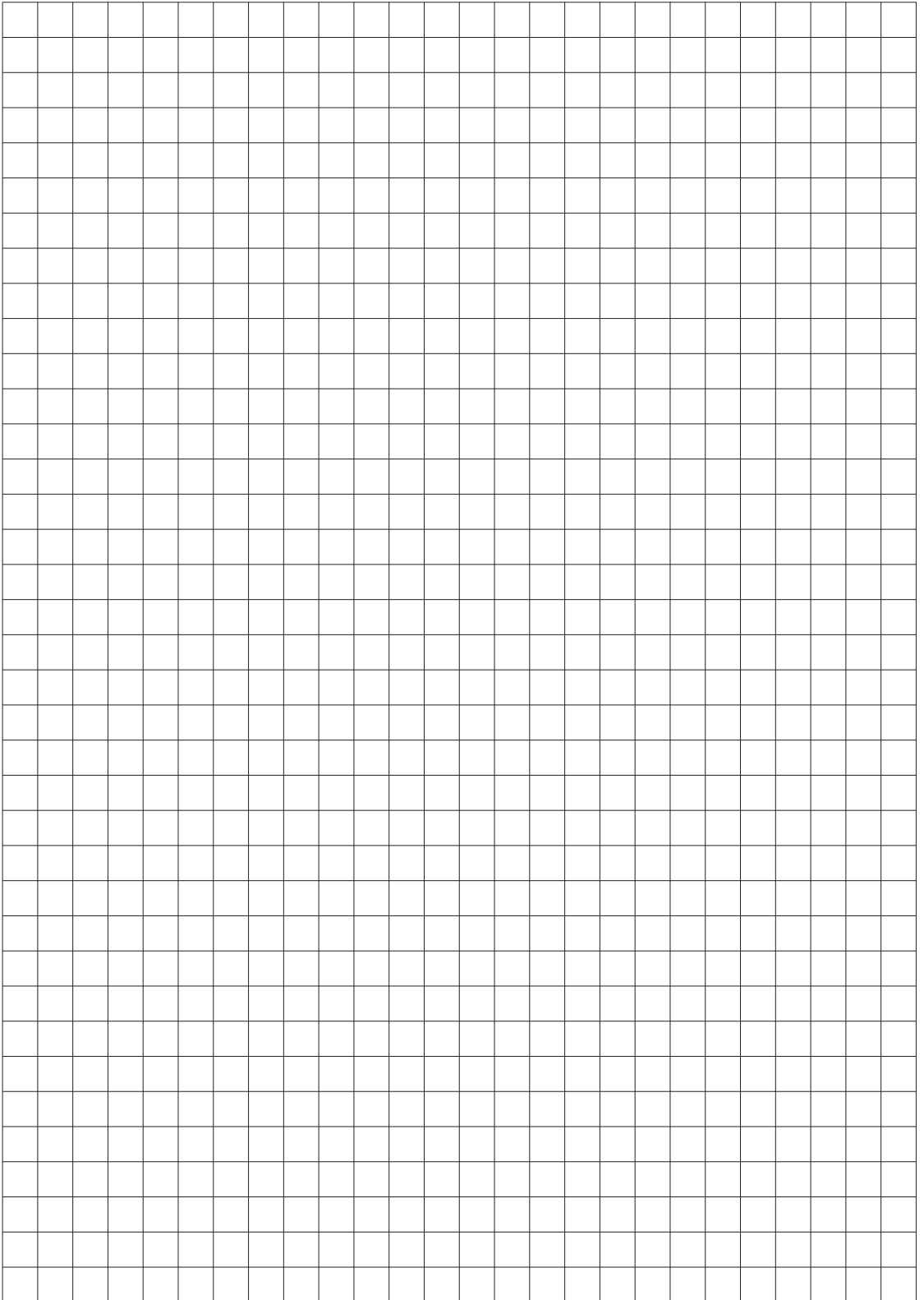
MOD. TÜBINGEN
 43953-10
 10 cm, 4"



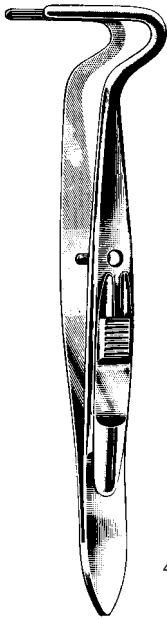
PRINCE
 43955-10
 10 cm, 4"



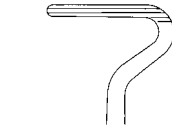
PRINCE
 43956-10
 10 cm, 4"



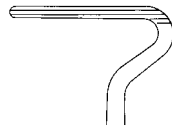
Muskelpinzetten, Fixationspinzetten
 Muscule Forceps, Fixation Forceps
 Pinzas musculares, Pinzas para fijación
 Pinze muscolari, Pinze per fissaggio



BERKE
 44015-20 - 44015-27
 10 cm, 4"



44015-20



44015-27



1x2
 TROUTMAN
 44017-08 8,5 cm, 3.4"
 0,8 mm



ELSCHNIG
 44046-11
 11 cm, 4 3/8"



GRAEFE
 44050-11 - 44052-11
 11 cm, 4 3/8"



44050-11



44052-11
 mit Sperre
 with catch
 con cierre
 c. cremagliera



LESTER
 44054-09
 9 cm, 3 1/2"

Fixierpinzetten, Kapselpinzette
 Fixation forceps, capsular forceps
 Pinzas para fijación, Pinzas capsulares
 Pinze fissatrici, Pinze per capsulari

1x1



CASTROVIEJO
 44066-09
 9 cm, 3 1/2"

1x1



CASTROVIEJO
 44067-09
 9 cm, 3 1/2"

2x2

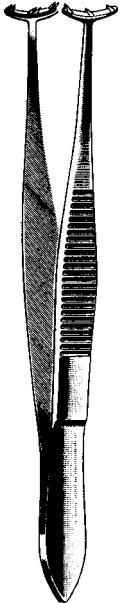


CASTROVIEJO
 44068-09
 9 cm, 3 1/2"

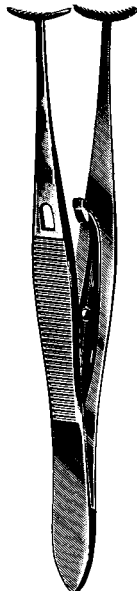
2x2



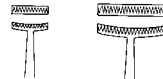
CASTROVIEJO
 44069-09
 9 cm, 3 1/2"



BARRAQUER
 44074-10
 10 cm, 4"

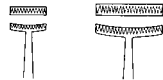


GREEN
 44076-05 - 44078-10
 10 cm, 4"



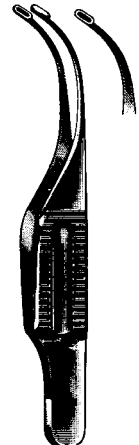
44076-05 5 mm
 44076-10 10 mm

ohne Sperre
 without catch
 sin cierre
 senza cremagliera



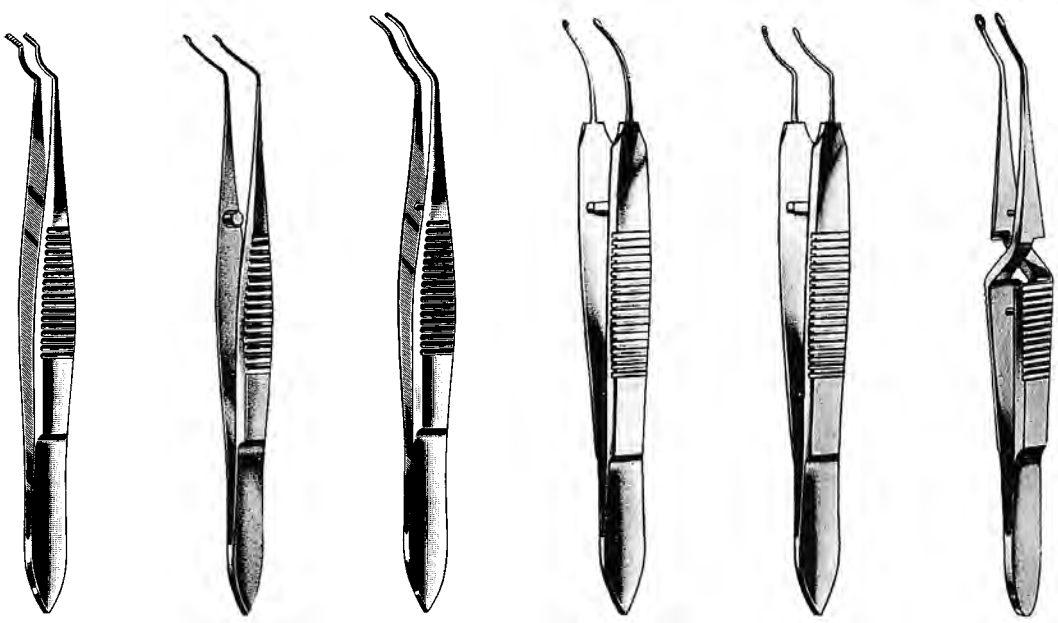
44078-05 5 mm
 44078-10 10 mm

mit Sperre
 with catch
 con cierre
 con cremagliera



GILL-ARRUGA
 44101-07
 7,5 cm, 3"

Fixierpinzetten, Kapselpinzette
 Fixation forceps, capsular forceps
 Pinzas para fijación, Pinzas capsulares
 Pinze fissatrici, Pinze per capsulari



TERSON
44103-09
9 cm, 3 1/2"

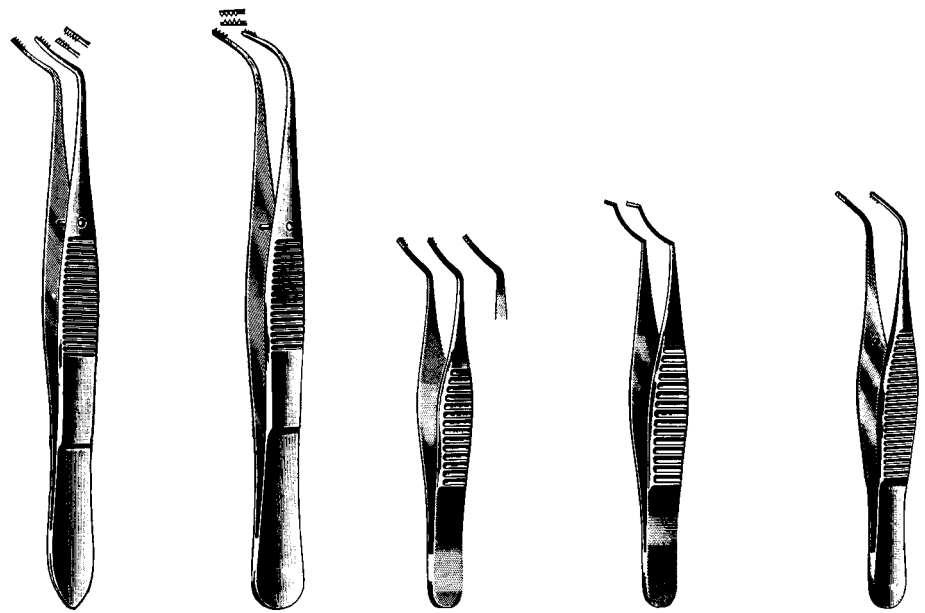
KALT
44106-10
10 cm, 4"

ELSCHNIG
44109-10
10 cm, 4"

ARRUGA
44111-10
10 cm, 4"

ARRUGA
44114-10
10 cm, 4"

CASTROVIEJO
44115-10
10 cm, 4"



SCHWEIGGER
44119-10
10 cm, 4"

ELSCHNIG
44121-10
10 cm, 4"

HESS
44125-06
6 cm, 2.4"

HESS
44127-06
6,5 cm, 2.6"

FUCHS
44129-07
7 cm, 2 3/4"

Nahtpinzetten, Fadenpinzetten
Suture Forceps, Tying Forceps
Pinzas para suturas y hilo
Pinze per sutura, Pinze per filo

1x2



CASTROVIEJO

10 cm, 4"

44150-01

0,12 mm

44150-03

0,30 mm

44150-05

0,50 mm

44150-10

1,00 mm

44150-15

1,50 mm

1x2



CASTROVIEJO

10 cm, 4"

44151-05

44151-10

44151-15

Zahn
tooth
diente
dente

MOORFIELD

44164-10

10 cm, 4"



St. MARTIN

44166-07

7 cm, 2 3/4"



Mod. TÜBINGEN

44181-10

10 cm, 4"

1x2



PAUFIQUE

44190-08

8,5 cm, 3.4"



PAUFIQUE

44202-08

8,5 cm, 3.4"



McPHERSON

44210-10

10 cm, 4"



McPHERSON

44220-10

10 cm, 4"

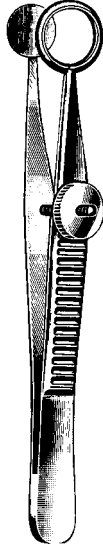
Pinzetten für Chalazion und Trachom
 Forceps for Chalazion and Trachoma
 Pinzas de chalazión y para trachoma
 Pinze per calazio e per trichiasi

10 mm



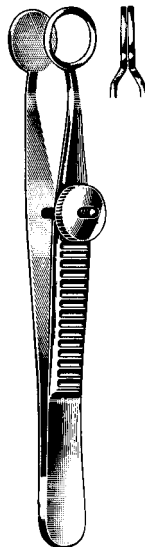
AYER
 44240-09
 9 cm, 3 1/2"

10 mm

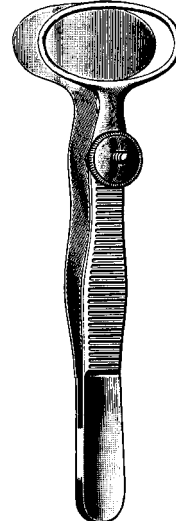


AYER
 44242-09
 9 cm, 3 1/2"

10 mm



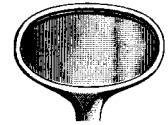
LAMBERT
 44246-09
 9 cm, 3 1/2"



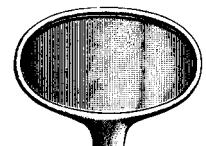
DESMARRES
 44254-09 - 44258-09
 9 cm, 3 1/2"



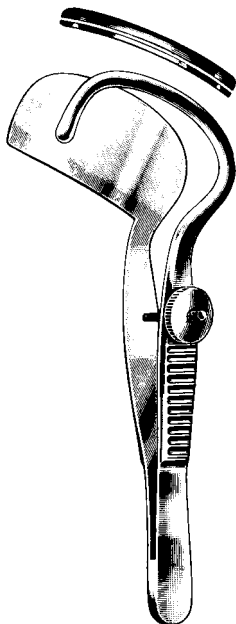
44254-09 20 mm
 Fig. 1



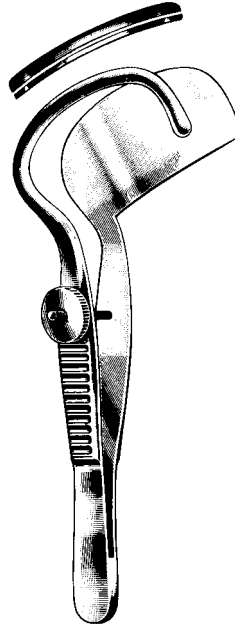
44256-09 24 mm
 Fig. 2



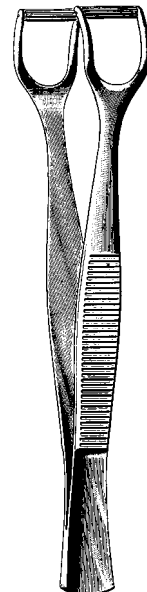
44258-09 32 mm
 Fig. 3



SNELLEN
 44265-10 10 cm, 4"

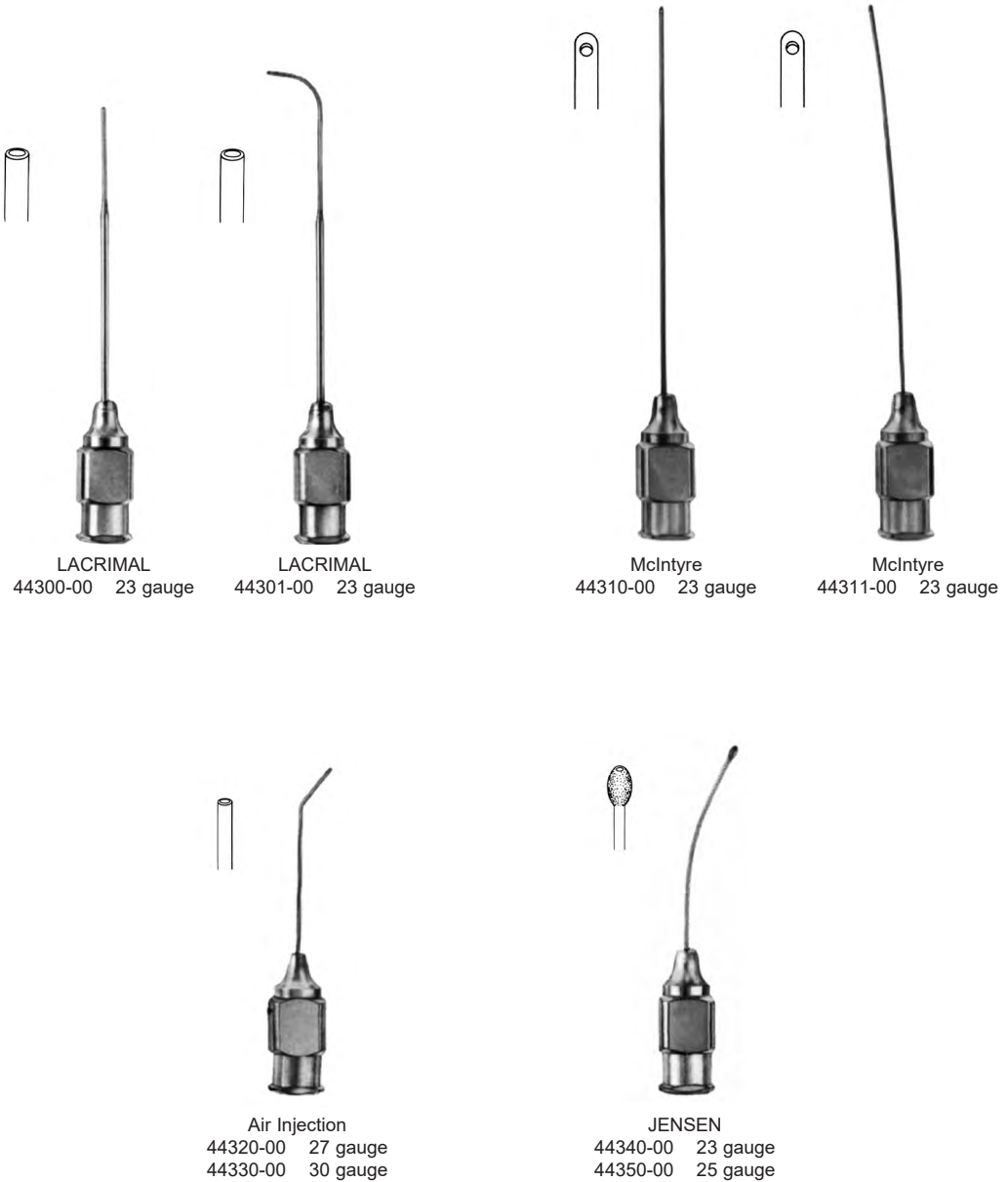


SNELLEN
 44267-10 10 cm, 4"



KNAPP-LUER
 44274-11 11 cm, 4 3/8"

Augenkanülen
 Eye Cannulas
 Cánulas oculares
 Cannule oculistiche



Spül- und Saugkanülen, Augenkanülen
Irrigation and Aspiration Cannulas, Eye Cannulas
Cánulas de irrigación y aspiración, Cánulas oculares
Cannule per irrigazione ed aspirazione, Cannule oculistiche



BISHOP-HARMON

44370-00 komplett / complete

44371-00 Silikonball / silicone bulb

44372-00 Adapter / adaptor

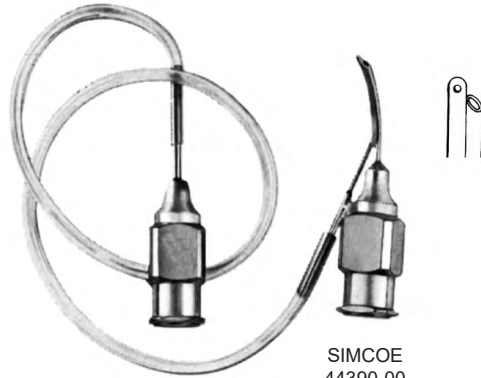
44373-00 19 gauge Kanüle / cannula

44374-00 21 gauge Kanüle / cannula

Augenkanülen, Tonometer
 Eye Cannulas, Tonometer
 Cánulas oculares, Tonómetro
 Cannule oculistiche, Tonometro



SHEETS
44380-00



SIMCOE
44390-00



SCHIOETZ
 44404-00 44406-00
 Skala gerade schräg
 scale straight oblique
 escala recta oblicua
 scala retta obliqua

44404-00 G geeicht
 44406-00 G calibrated
 calibrado
 calibrato

Augenmagnet, Cilienpinzetten
 Eye Magnet, Cilia Forceps
 Imàn para cuerpos extraños, Pinzas depilatorias
 Calamita per corpi estranei, Pinze depilatorie



REDA
44408-00



BEER
44420-09
9 cm, 3 1/2"



DOUGLAS
44422-09
9 cm, 3 1/2"



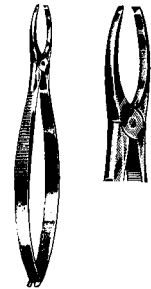
LITTAUER
44424-08
8,5 cm, 3.4"



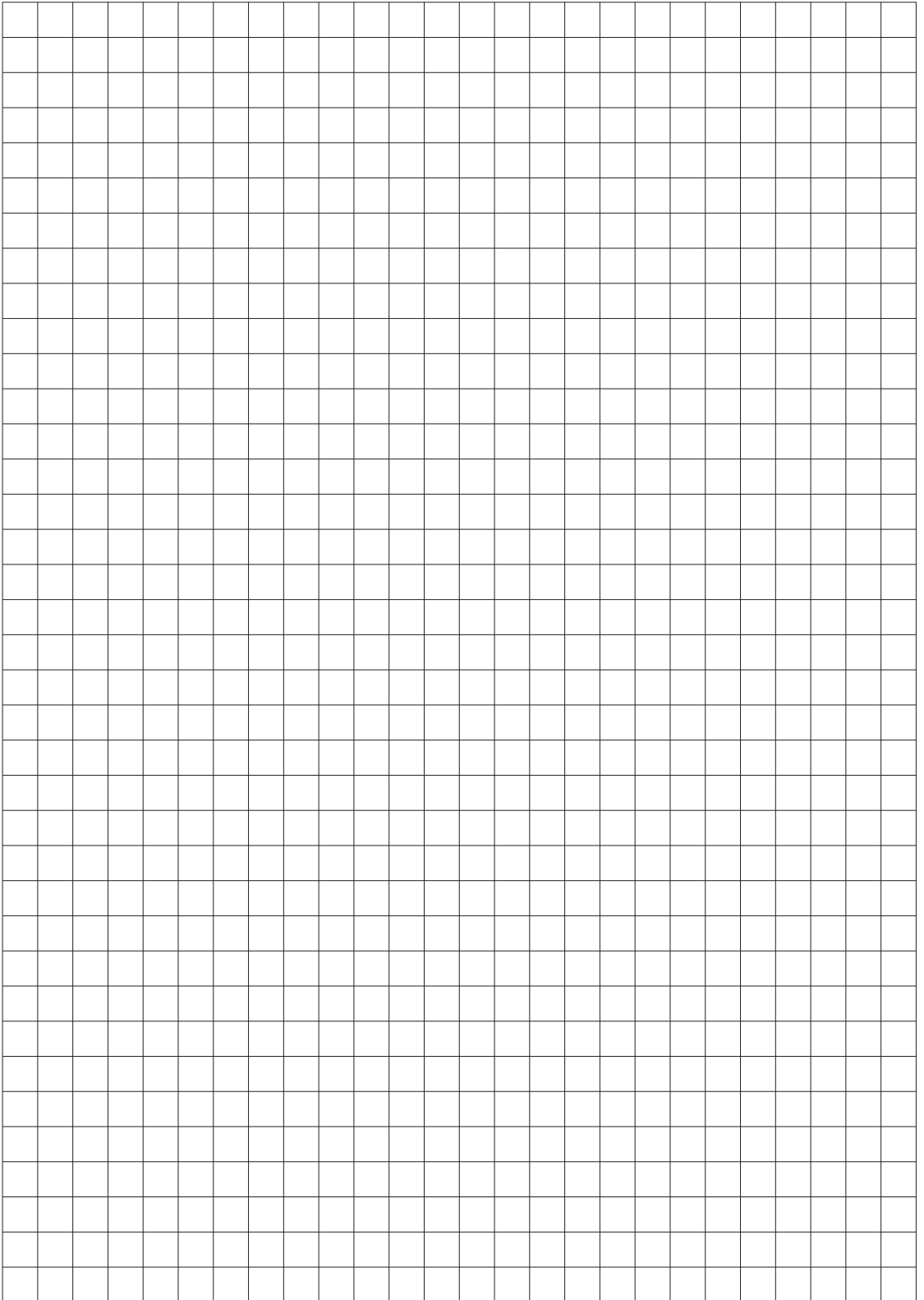
BARRAQUER
44425-10
10,5 cm, 4.1"



REDA
44426-09
9 cm, 3 1/2"



GRADLE
44428-09
9,5 cm, 3 3/4"



Ohrspekula
Ear Specula
Espéculos auriculares
Specoli auricolari

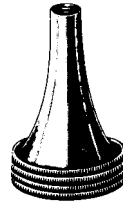


POLITZER
45009-00
Set = 3

Innen Ø
○ = 2,0 mm
45009-02

○ = 3,0 mm
45009-03

○ = 4,0 mm
45009-04



HARTMANN
45010-00
Set = 4
(4,5 / 5,5 / 6,5 / 7,5 mm)

Innen Ø
○ = 2,0 mm
45010-20

○ = 3,0 mm
45010-30

○ = 4,5 mm
45010-45

○ = 5,5 mm
45010-55

○ = 6,5 mm
45010-65

○ = 7,5 mm
45010-75



HARTMANN
45011-00
Set 3-7 mm

schwarz
black
negro
nero

Innen Ø
○ = 2,0 mm
45011-03

○ = 3,5 mm
45011-04

○ = 5,0 mm
45011-05

○ = 6,5 mm
45011-07

○ = 7,5 mm
45011-08



TOYNBEE
45012-00
Set = 3

Innen Ø
○ = 4,0 mm
45012-40

○ = 5,5 mm
45012-55

○ = 6,5 mm
45012-65

○ = 7,5 mm
45012-75

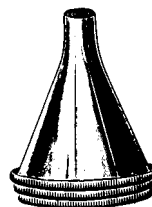


GRUBER, oval
45015-00
Set = 3

Innen Ø
○ = 4,5 mm
45015-45

○ = 5,5 mm
45015-55

○ = 6,5 mm
45015-65



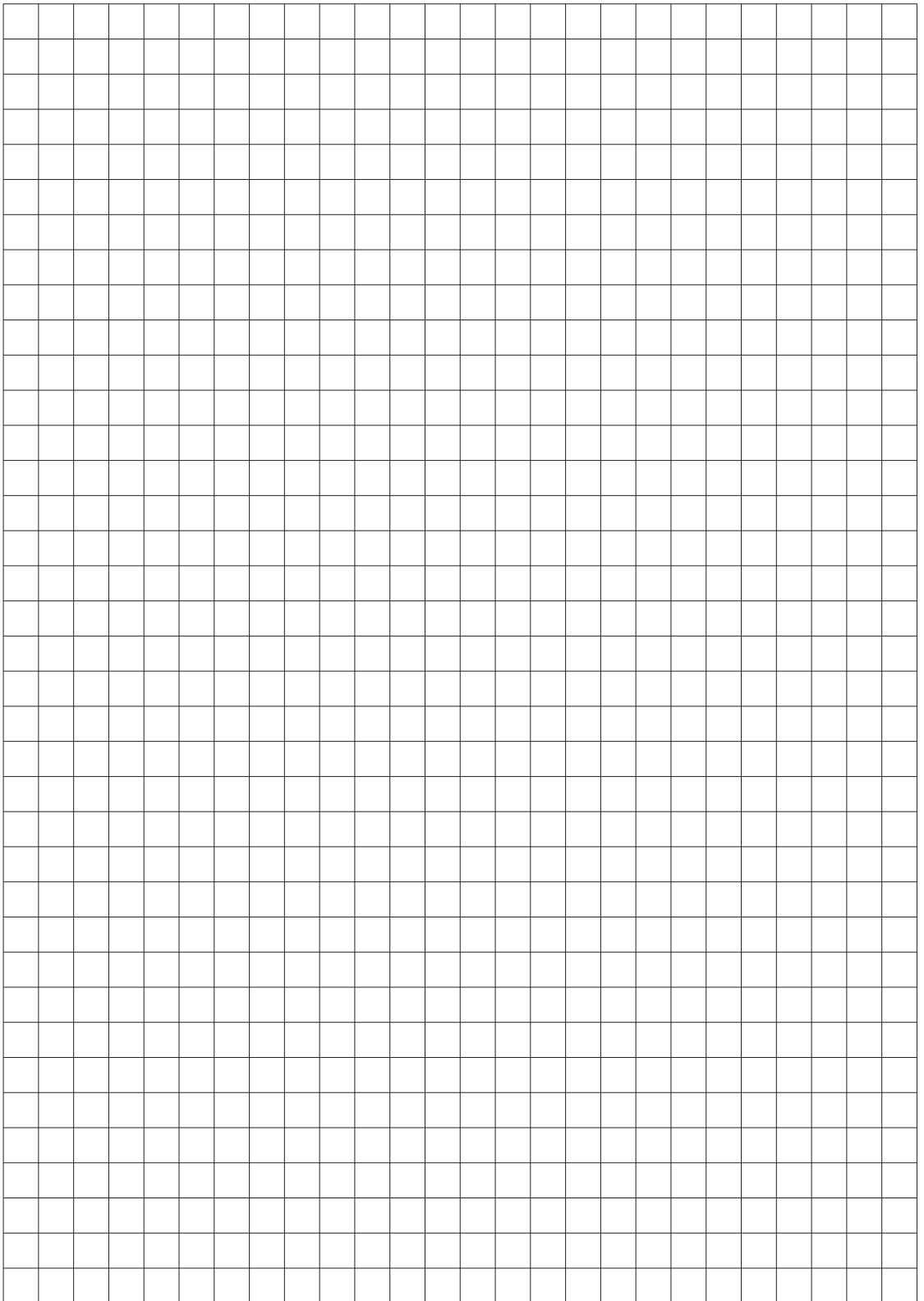
BOUCHERON
45018-00
Set = 4

Innen Ø
○ = 5,0 mm
45018-50

○ = 6,0 mm
45018-60

○ = 7,0 mm
45018-70

○ = 8,0 mm
45018-80



Ohrspekula
Ear Specula
Espéculos auriculares
Specoli auricolari

6,5 mm



45030-06

7,5 mm



45030-07

8,2 mm

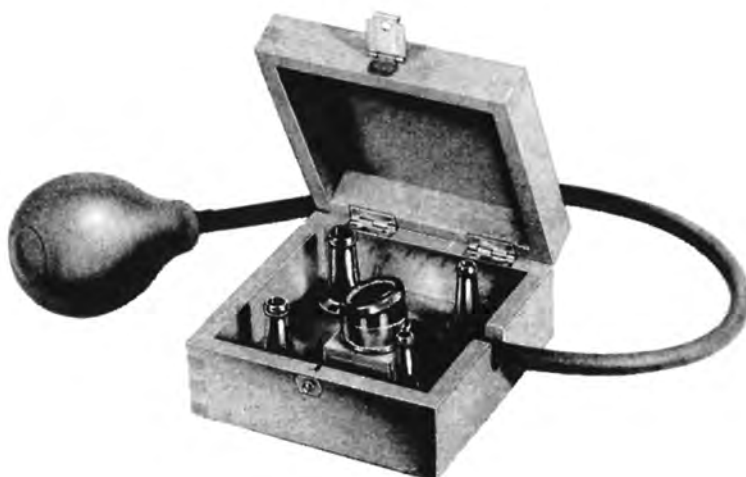


45030-08

10 mm



45030-10



BRUENINGS
45030-04

45030-04

Komplett bestehend aus:
4 Spekula, Saugkammer mit Gebläse,
Holzetui

Complete consisting of:
4 specula, suction head and rubber
tube with bulb, wooden case

Compuesto de:
4 espéculos, cámara de aspiración,
insuflador de goma, en estuche de
madera

Composta da:
4 specoli, camera aspirante con
soffiatrice, scatola di legno

Ersatzteile / spare parts /
repuestos / pezzi di ricambio

45036-09

Lupe / Magnification glass /
lupa / lente d'ingrandimento

45036-10

Saugpumpe / rubber ball /
pera de goma / soffiatrice di gomma

Ohrspekula
 Ear Specula
 Espéculos auriculares
 Specoli auricolari



7,5 mm Ø



45036-06



8,5 mm Ø



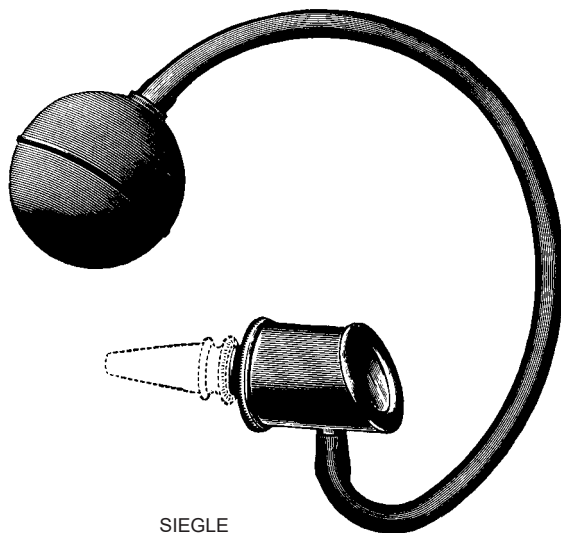
45036-07



9,5 mm Ø



45036-08



SIEGLE
 45036-03

45036-03

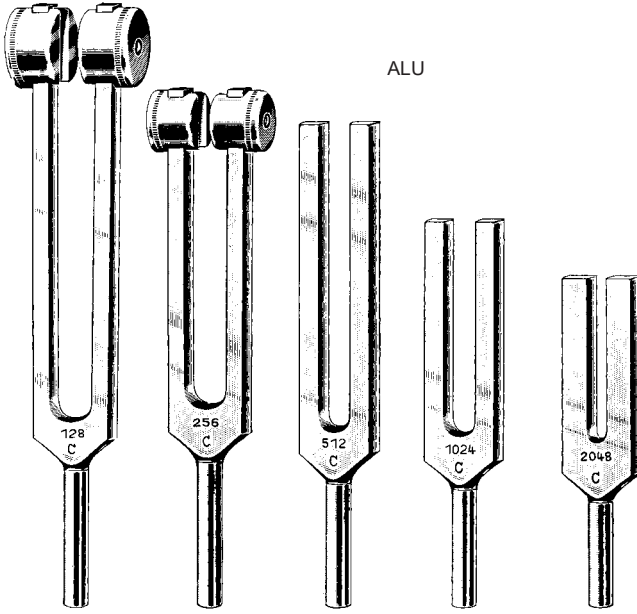
Komplett bestehend aus:
 Ohrspekulum, 3 Spekula, 1 Gebläse

Complete consisting of:
 Ear Specula, 1 rubber tube with bulb

Compuesto de:
 Otoscopio con 3 espéculos, insuflador y tubo

Composta da:
 Otoscopio con 3 specoli e 1 insufflatore con tubo

Stimmgabeln
Tuning Forks
Diapasones
Diapason



ALU

45060-01
C 128

45060-02
C¹ 256

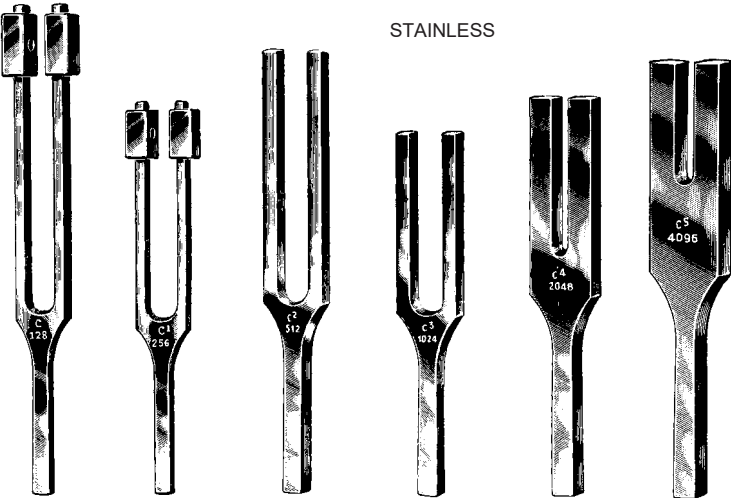
45060-03
C² 512

45060-04
C³ 1024

45060-05
C⁴ 2048



45061-00
compl.



STAINLESS

45070-01
C 128

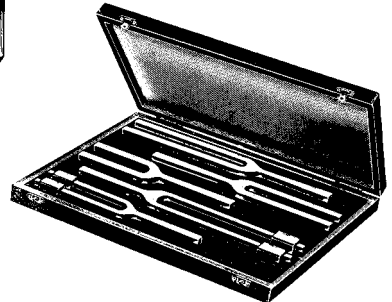
45070-02
C¹ 256

45070-03
C² 512

45070-04
C³ 1024

45070-05
C⁴ 2048

45070-06
C⁵ 4096



HARTMANN
45071-00
compl.

HARTMANN

Stimmgabeln
Tuning Forks
Diapasones
Diapason

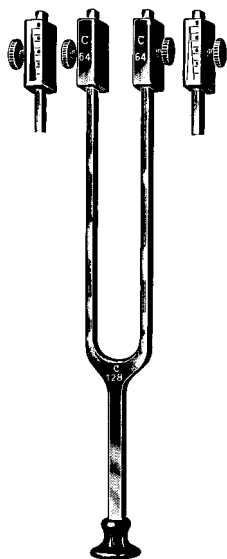


45072-01
a¹ 440



LUCAE

- 45073-01 C 128
- 45073-02 C¹ 256
- 45073-03 C² 512
- 45073-04 C³ 1024
- 45073-05 C⁴ 2048
- 45073-06 C⁵ 4096



RYDEL-SEIFFERT
45076-01 C 128 / C 64



LUCAE
45074-01
C 128

Spritze, Küretten
 Syringe, Curettes
 Jeringa, Curetas
 Siringa, Curette



ml REINER
 50 45096-50
 75 45096-75
 100 45097-10
 150 45097-15



	Innen Ø	1.5 mm	1.9 mm	2.5 mm	2.7 mm	3.4 mm	4.0 mm	4.5 mm
Küretten Curettes Curetas Curette								
		Fig. 00	0	1	2	3	4	5
stumpf blunt romas smusse		45109-00	45110-00	45110-01	45110-02	45110-03	45110-04	45110-05
scharf sharp cortantes taglianti		45111-00	45112-00	45112-01	45112-02	45112-03	45112-04	45112-05
stumpf blunt romas smusse		45114-00	45115-00	45115-01	45115-02	45115-03	45115-04	45115-05
scharf sharp cortantes taglianti		45116-00	45117-00	45117-01	45117-02	45117-03	45117-04	45117-05

BUCK
 14,5 cm, 5 3/4"

Ohrkatheter, Parazentese Nadeln, Ohrmesser
 Catheters, Paracentesis Needles, Ear Knives
 Cateteres, agujas para paracentesis, Cuchillos auriculares
 Cateteri, Aghi per paracentesi, Coltelli auricolari

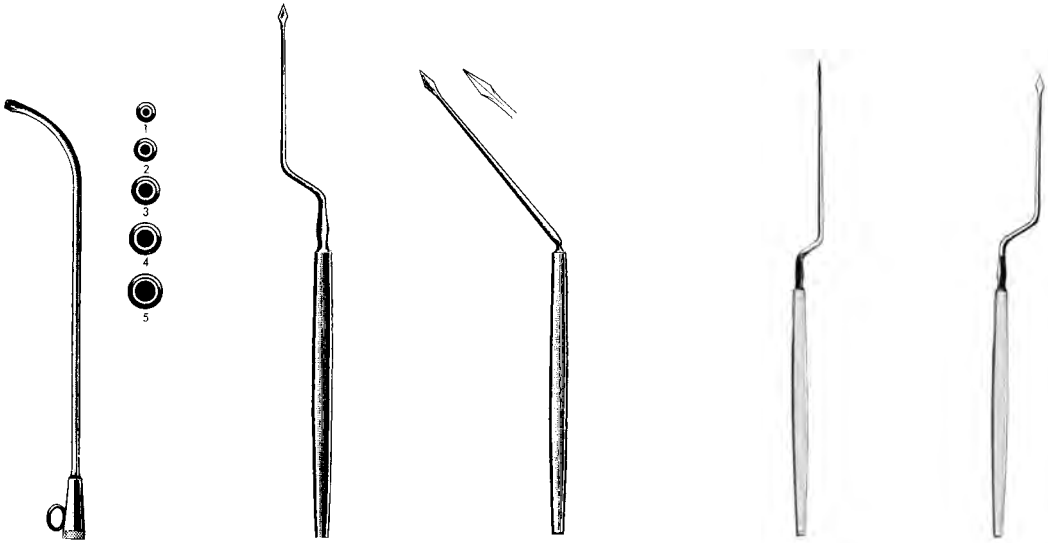


Fig. HARTMANN

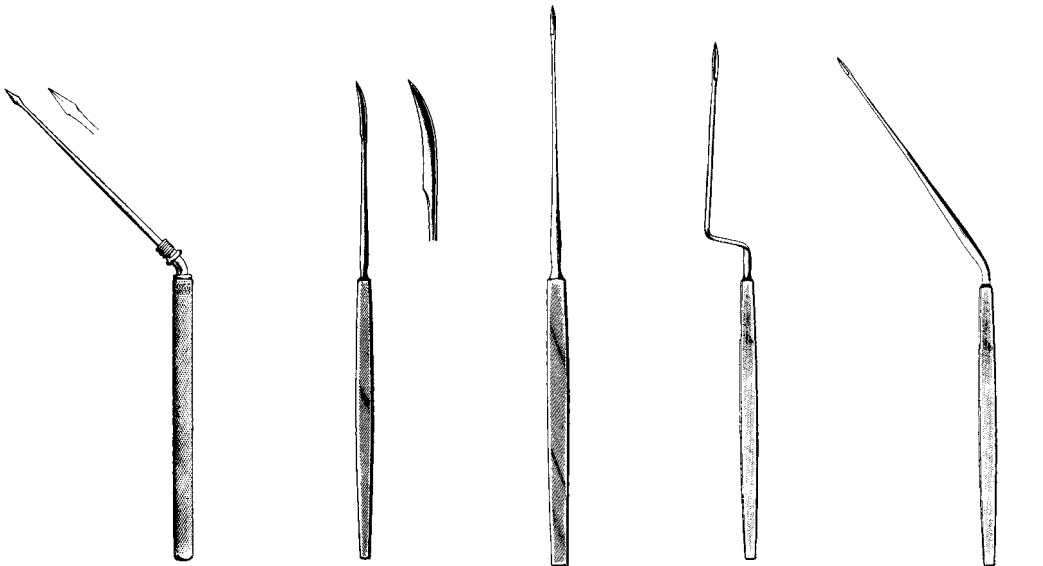
- | | | |
|---|----------|--------|
| 1 | 45133-01 | 3,5 mm |
| 2 | 45133-02 | 4,0 mm |
| 3 | 45133-03 | 4,5 mm |
| 4 | 45133-04 | 5,0 mm |
| 5 | 45133-05 | 6,0 mm |

POLITZER
 45150-18
 18 cm, 7"

POLITZER
 45151-16
 16,5 cm, 6 1/2"

LUCAE
 45152-01
 18 cm, 7"

LUCAE
 45152-02
 18 cm, 7"



POLITZER
 45153-16
 16 cm, 6 1/4"

POLITZER
 45160-15
 15 cm, 6"

SEXTON
 45162-18
 18 cm, 7"

SEXTON
 45164-17
 17 cm, 6 3/4"

SEXTON
 45165-17
 17 cm, 6 3/4"

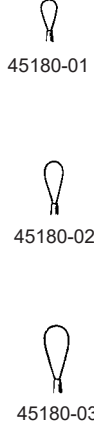
Löffel, Schlingen, Häkchen
 Ear spoons, Loops, Hooklets
 Cucharas, Asas, Ganchitos
 Cucchiai, Anse, Uncinetti



GROSS
 45171-12
 12 cm, 4 3/4"



BILLEAU
 16 cm, 6 1/4"



45180-01
 45180-02
 45180-03



LANGENBECK
 45181-13
 13 cm, 5 1/8"



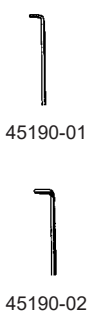
ZAUFAL
 45184-16
 16 cm, 6 1/4"



ZAUFAL-JANSEN
 45185-15
 15 cm, 6"



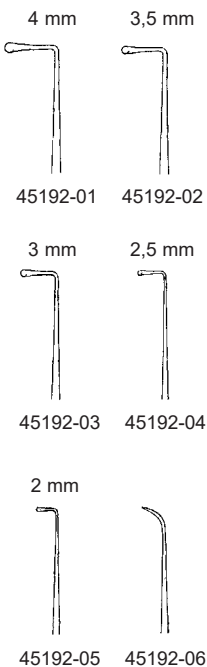
DAY
 16 cm, 6 1/4"



45190-01
 45190-02



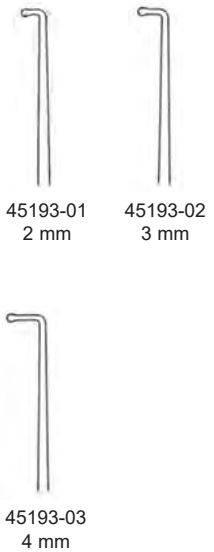
WAGENER
 14 cm, 5 1/2"



4 mm 3,5 mm
 45192-01 45192-02
 3 mm 2,5 mm
 45192-03 45192-04
 2 mm
 45192-05 45192-06

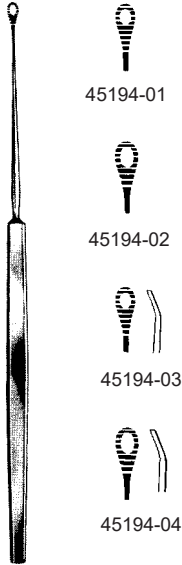


LUCAE
 14 cm, 5 1/2"

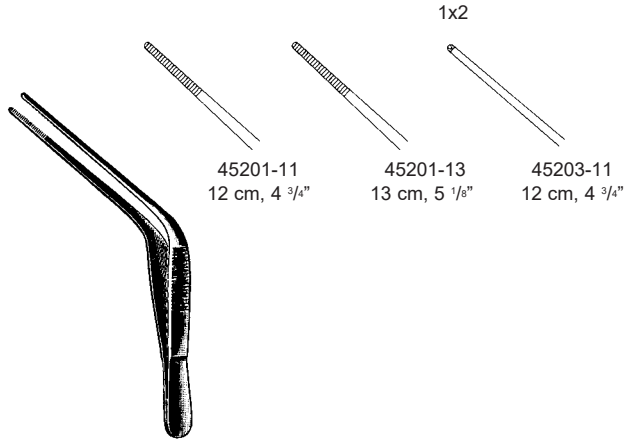


45193-01 45193-02
 2 mm 3 mm
 45193-03
 4 mm

Schlingen, Pinzetten
 Loops, Dressing Forceps
 Asas, Pinzas
 Anse, Pinze



SHAPLEIGH
 13 cm, 5 1/8"



WILDE (TROELTSCH)



LUCAE
 45206-14
 14 cm, 5 1/2"



LUCAE
 16 cm, 6 1/4"

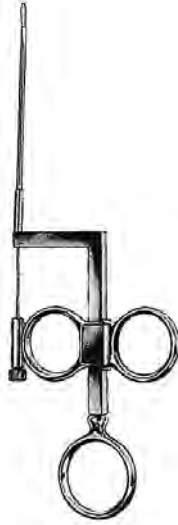


COTTLE
 45208-14
 14 cm, 5 1/2"

Polypenschnürer, Ohrzängchen
Snares, Ear Forceps
Cierra-nudos, Pinzas auriculares
Serranodi, Pinze auricolari



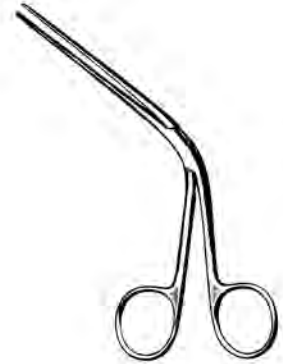
KRAUSE
45220-16
16 cm, 6 1/4"



WILDE
45222-17
17 cm, 6 3/4"



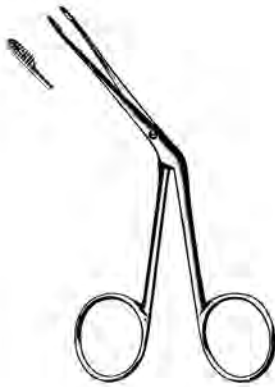
45225-02
doz./doc./dozz.
0,2 mm



TILLEY
45243-14
14 cm, 5 1/2"



LITTAUER
45245-12
12 cm, 4 3/4"



HARTMANN
45246-12
12 cm, 4 3/4"

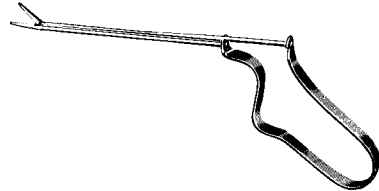


HARTMANN
45246-14
14 cm, 5 1/2"

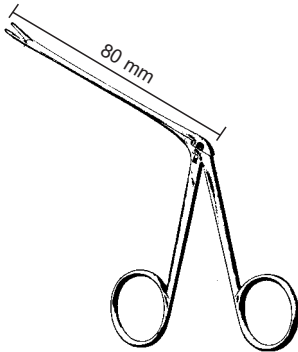
Fremdkörperheber, Fremdkörperzängchen
 Foreign Body Levers, Ear Polypus Forceps
 Elevadores para cuerpos extraños, Pinzas para pólipos
 Leve per corpi estranei, Pinze per polipi



QUIRE
 45251-10
 10 cm, 4"



BUCK
 45253-11
 11 cm, 4 3/8"



45255-08 - 45275-08



HARTMANN-WULLSTEIN
 45255-08
 8,5 cm, 3.4"

o 1 mm Ø



HARTMANN-WULLSTEIN
 45257-08
 8,5 cm, 3.4"



HARTMANN
 45261-08 8,5 cm, 3.4"
 45261-14 14,0 cm, 5 1/2"
 45261-16 16,0 cm, 6 1/4"



HARTMANN
 45263-08 8,5 cm, 3.4"
 45263-14 14,0 cm, 5 1/2"



HARTMANN
 45265-08
 8,5 cm, 3.4"



Ø mm HARTMANN
 2,0 45267-20 8,5 cm, 3.4"
 2,5 45267-25 8,5 cm, 3.4"
 3,0 45267-30 8,5 cm, 3.4"

o 3 mm Ø



HARTMANN
 45269-30
 8,5 cm, 3.4"



STRUEMPEL
 45271-08 8,5 cm, 3.4"
 2,5x5 mm



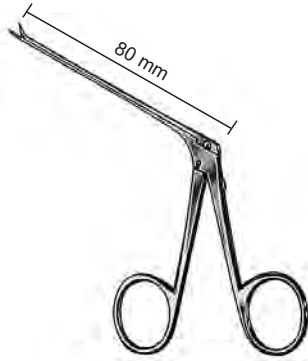
HARTMANN
 45273-08
 8,5 cm, 3.4"

o 2 mm Ø

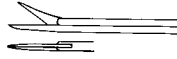


HARTMANN-HOFFMANN
 45275-08
 8,5 cm, 3.4"

Mikro-Ohrscheren, Mikro-Ohrzängchen
 Micro Ear Scissors, Micro Ear Forceps
 Tijeras auriculares micro, Pinzas auriculares micro
 Forbici auricolari micro, Pinze auricolari micro



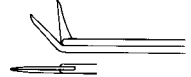
45310-40 - 45322-70



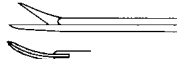
A
 BELLUCCI
 45310-40
 micro mini
 4 mm



A
 BELLUCCI
 45312-55
 micro standard
 5,5 mm



D
 BELLUCCI
 45313-55
 micro standard
 5,5 mm



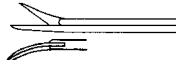
B
 BELLUCCI
 45315-55
 micro standard
 5,5 mm



C
 BELLUCCI
 45317-55
 micro standard
 5,5 mm



A
 SHEA
 45320-70
 7,0 mm



C
 SHEA
 45321-70
 7,0 mm



B
 SHEA
 45322-70
 7,0 mm

- A:** gerade / straight / recta / retta
B: rechts / right / derecha / destra
C: links / left / izquierda / sinistra
D: aufgebogen / curved up / curva in alto / curva hacia arriba
E: nach unten gebogen / curved down / curva in basso / curva hacia abajo



45350-40 - 45360-35



A
 45350-40
 4 mm



A
 45350-70
 7 mm



A
 45352-40
 4 mm



C
 45353-60
 6 mm



B
 45355-60
 6 mm



D
 45357-40
 4 mm



E
 45359-40
 4 mm



A
 45360-35
 3,5 mm

Mikro-Ohrzängchen, Hammerkopfstanze

Micro Ear Forceps, Malleus punch

Pinzas auriculares micro, Pinza saca-bocadas para cabeza de martillo

Pinze auricolari micro, Pinze taglianti per testa del martelletto taglio a scalpello



45362-45 - 45383-30



A
45362-45
4,5 mm



C
45363-45
4,5 mm



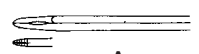
B
45365-45
4,5 mm



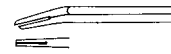
D
45367-50
5,0 mm



E
45369-50
5,0 mm



A
GREVEN
45370-50
5,0 mm



McGEE
45371-40
0,8x4,0 mm



COS
45373-30
1,8x0,8x3,0 mm



JUERS
45375-60
6,0 mm



JUERS
45377-60
6,0 mm



B
HAUGH
45383-30
45° 3 mm

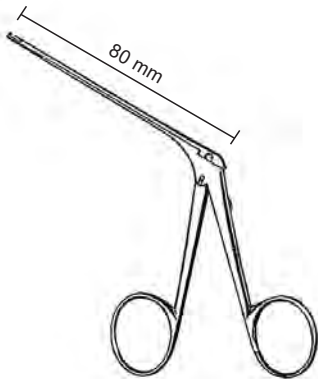
A: gerade / straight / recta / retta

B: rechts / right / derecha / destra

C: links / left / izquierda / sinistra

D: aufgebogen / curved up / curva in alto / curva hacia arriba

E: nach unten gebogen / curved down / curva in basso / curva hacia abajo



DIETER
45385-01 - 45387-02

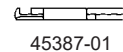
micro ø 1,3 mm



45385-01

aufwärts
upward
arriba
in alto

mini ø 1,8 mm

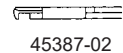


45387-01



45385-02

abwärts
downward
abajo
in basso



45387-02

Mikro-Ohrzangchen
 Micro Ear Forceps
 Pinzas auriculares micro
 Pinze auricolari micro



45390-35
 0,8 x 3,5 mm



45390-50
 1 x 5 mm



45391-35
 0,8 x 3,5 mm



45392-35
 0,8 x 3,5 mm



45393-50
 1 x 5 mm



45394-50
 1 x 5 mm

Mikro-Ohrzängchen
 Micro Ear Forceps
 Pinzas auriculares micro
 Pinze auricolari micro



WULLSTEIN

45400-01
0,9 x 1 mm45400-02
0,8 x 1,3 mm45400-03
1 mm45401-25
1,7 x 2,5 mm45402-10
0,9 x 1 mm45403-13
0,8 x 1,3 mm45404-13
0,8 x 1,3 mm

Mikro-Ohrscheren
Micro Ear Scissors
Tijeras auriculares micro
Forbici auricolari micro



WULLSTEIN



45410-01



45411-01



45412-01



45413-01



45414-01

Messer
Knives
Cuchillos
Coltelli



SCHUKNECHT
45701-01
16 cm, 6 1/4"



SCHUKNECHT
45701-02
16 cm, 6 1/4"



SCHUKNECHT
45703-15
15,5 cm, 6"



WULLSTEIN
45704-15
15,5 cm, 6"



TABB
45705-15
15,5 cm, 6"

3,5 mm Ø



PLESTER
45706-35
15,5 cm, 6"



ROSEN
45709-10 - 45709-30
16 cm, 6 1/4"



45709-10
Ø 1,0 mm



45709-14
Ø 1,4 mm



45709-16
Ø 1,6 mm



45709-20
Ø 2,0 mm



45709-26
Ø 2,6 mm



45709-28
Ø 2,8 mm



45709-30
Ø 3,0 mm

Nadeln und Häkchen
Needles and Hooks
Agujas y Ganchos
Aghi e uncini



16 cm
6 1/4"



BARBARA
45710-15



BARBARA
45711-15



BARBARA
45713-15



BARBARA
45715-17



25°
SHAMBAUGH
mm 0,3 45720-03
0,6 45720-06
1,0 45720-10



45°
SHAMBAUGH
mm 0,3 45722-03
0,6 45722-06
1,0 45722-10
1,2 45722-12
1,5 45722-15
2,0 45722-20
2,5 45722-25



90°
SHAMBAUGH
mm 0,3 45724-03
0,6 45724-06
1,0 45724-10
1,2 45724-12
1,5 45724-15
2,0 45724-20
2,5 45724-25



BARBARA
45725-05=0,5 mm
45725-10=1,0 mm



45730-03 - 45747-10
15,5 cm, 6"



90°
mm 0,3 45730-03
0,6 45730-06
1,0 45730-10



90°
mm 0,3 45732-03
0,6 45732-06
1,0 45732-10



mm 0,5 45733-05
1,0 45733-10



McGEE
mm 0,5 45735-05
1,0 45735-10



BARBARA
45736-15
15,5 cm, 6"



ROSEN
45737-15
15,5 cm, 6"



mm 0,3 45741-03
0,6 45741-06
1,0 45741-10



25°
mm 0,3 45743-03
0,6 45743-06
1,0 45743-10

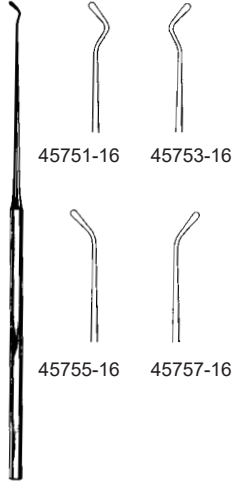


25°
mm 0,3 45745-03
0,6 45745-06
1,0 45745-10

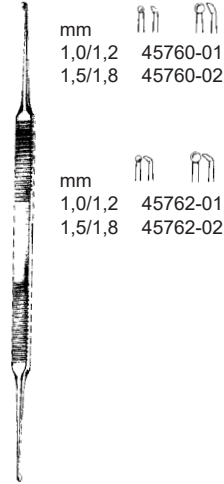


45°
mm 0,3 45747-03
0,6 45747-06
1,0 45747-10

Dissektoren, Küretten, Elevatoren, Mikro-Meßsonde
 Dissectors, Curettes, Elevators, Micro measuring rod
 Dissectores, Curetas, Elevadores, Sonda para medir
 Dissettori, Curette, Elevatori, Sonda auricolare per misurare



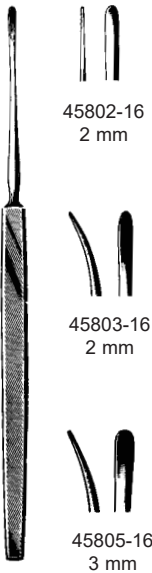
FISCH
 45751-16 - 45757-16
 16 cm, 6 1/4"



HOUSE
 45760-01 - 45762-02
 15 cm, 6"

mm
 1,0/1,2 45760-01
 1,5/1,8 45760-02

mm
 1,0/1,2 45762-01
 1,5/1,8 45762-02

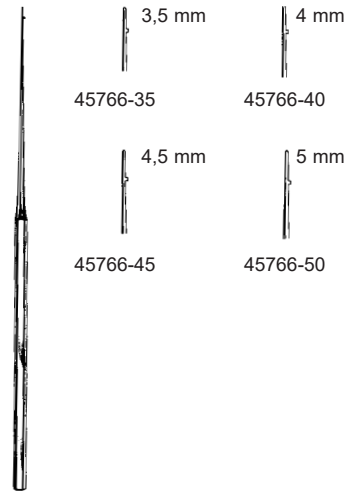


LEMPERT
 45802-16 - 45805-16
 16 cm, 6 1/4"

45802-16
 2 mm

45803-16
 2 mm

45805-16
 3 mm



HOUSE
 45766-35 - 45766-50
 16 cm, 6 1/4"

3,5 mm
 45766-35

4 mm
 45766-40

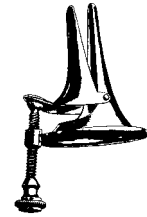
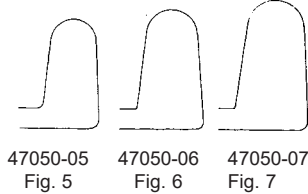
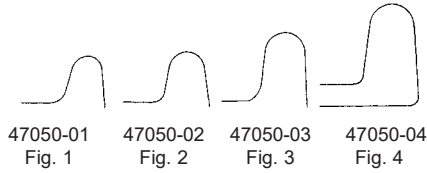
4,5 mm
 45766-45

5 mm
 45766-50

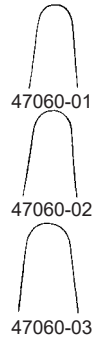
Nasenspekula
Nasal Specula
Especulos nasales
Specoli nasali



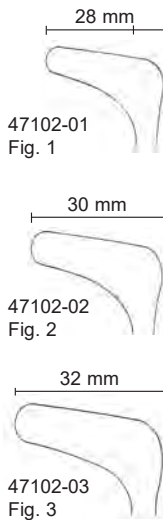
THUDICHUM
47050-01 - 47050-07



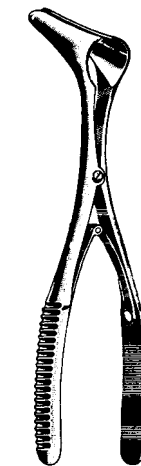
VOLTOLINI
47060-01 - 47060-03



HARTMANN-HALLE
47102-01 - 47102-03
15 cm, 6"



Baby, bébé
Kind, child, niño, bamb.
Erwachs., Adult, adulto



Mod. WIEN
47112-01 25 mm
47112-02 30 mm
47112-03 35 mm



Mod. WIEN
47113-03

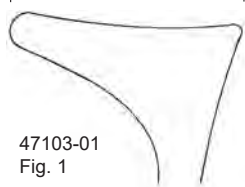
leichtes Modell
lightweight
mod. ligero
mod. leggero

Nasenspekula
Nasal Specula
Espéculos nasales
Specoli nasali



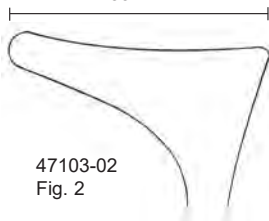
HARTMANN
16 cm, 6 1/4"

30 mm



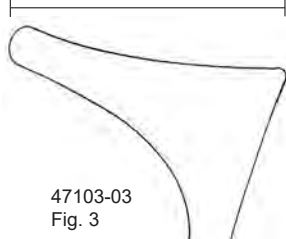
47103-01
Fig. 1

33 mm



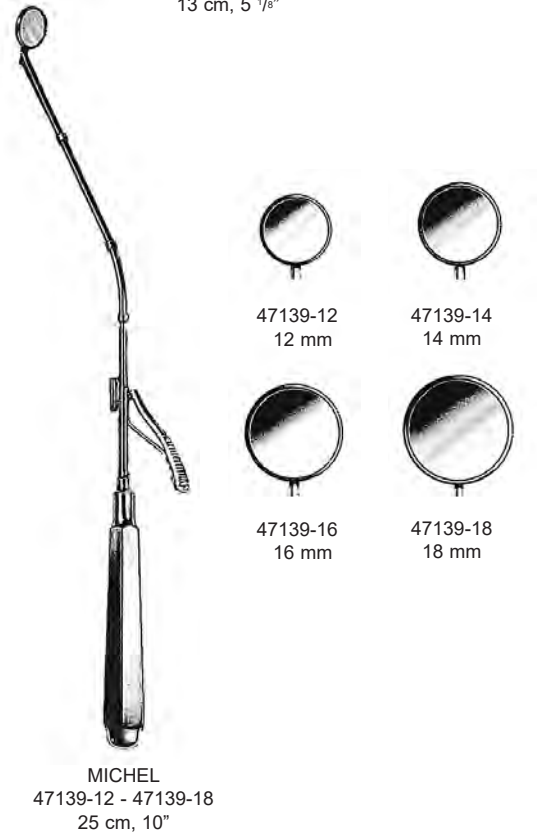
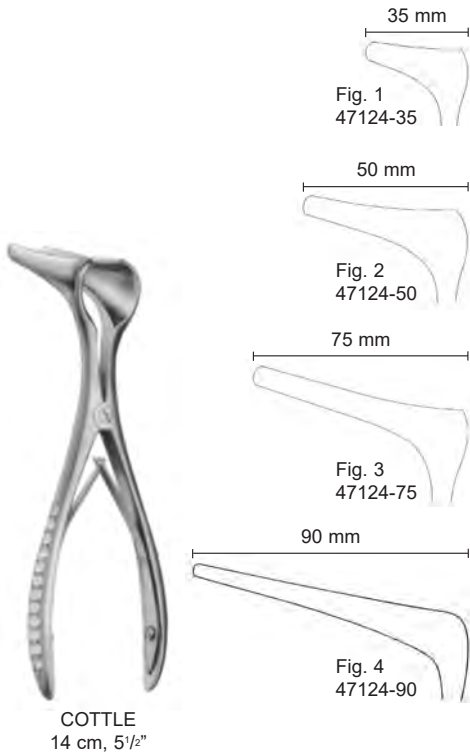
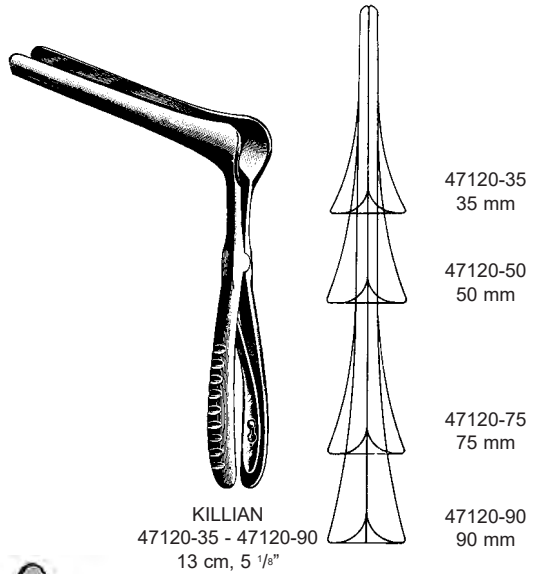
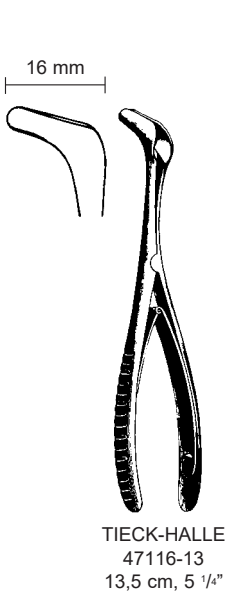
47103-02
Fig. 2

35 mm

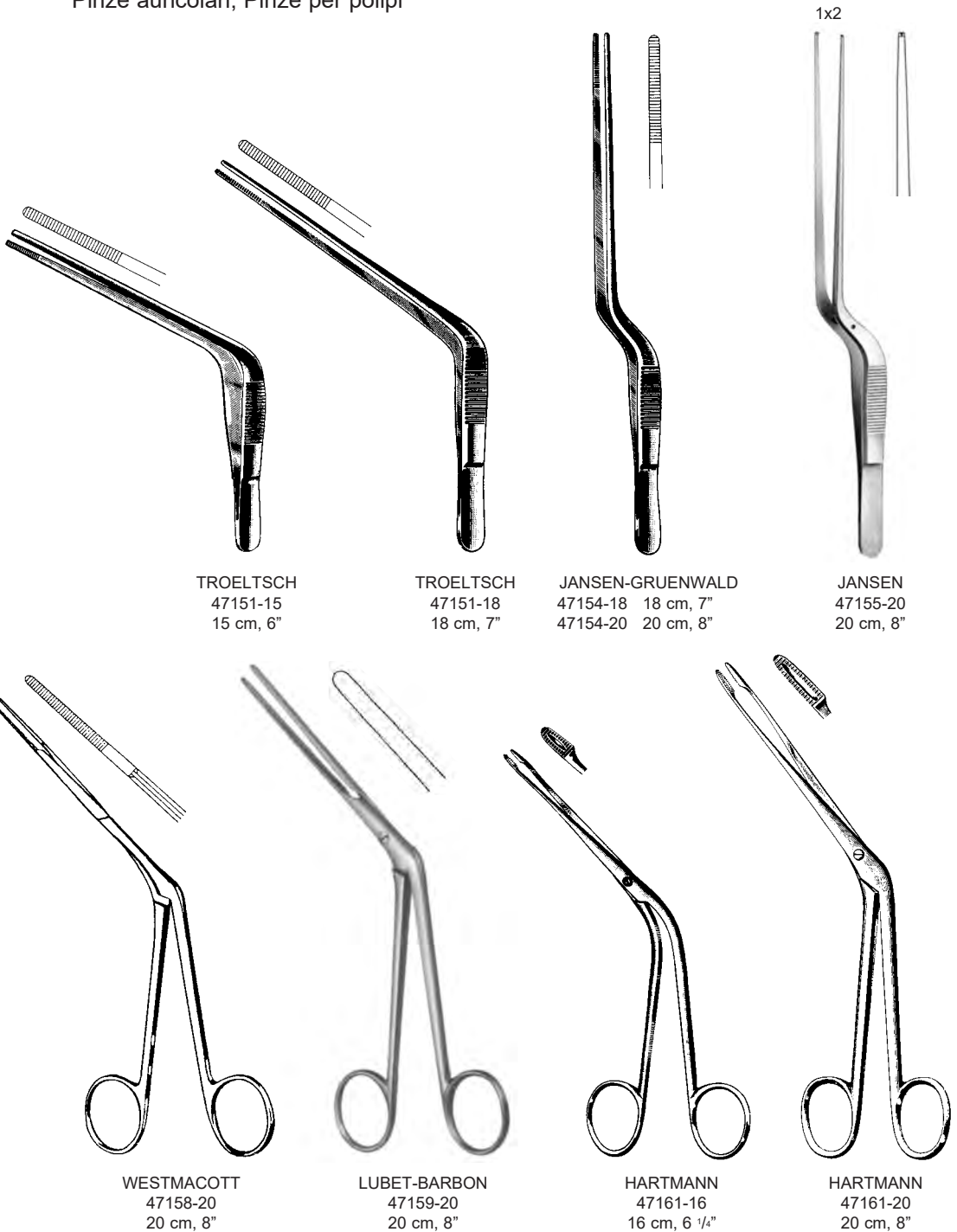


47103-03
Fig. 3

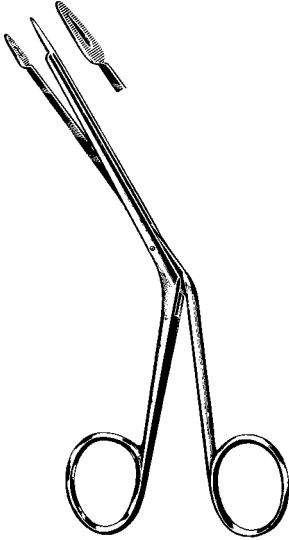
Nasenspekula, Kehlkopfspiegel
 Nasal Specula, Laryngeal Mirrors
 Espéculos nasales, espejos laríngeos
 Specoli nasali, Specchi laringei



Nasenpinzetten, Polypenzange
 Ear Dressing Forceps, Ear Polypus Forceps
 Pinzas auriculares, Pinzas para pólipos
 Pinze auricolari, Pinze per polipi



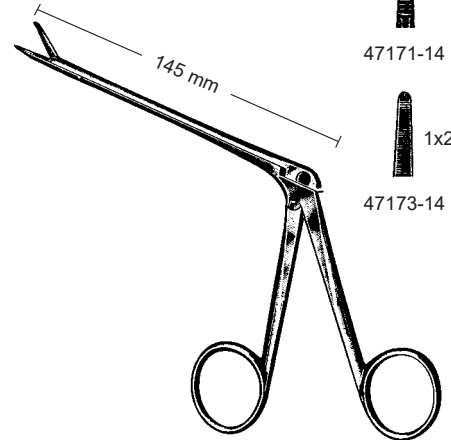
Polypenzangen, Septumzangen
 Nasal Polypus and Septum Forceps
 Pinzas para pólipos y para el tabique nasal
 Pinze per polipi, Pinze per il setto nasale



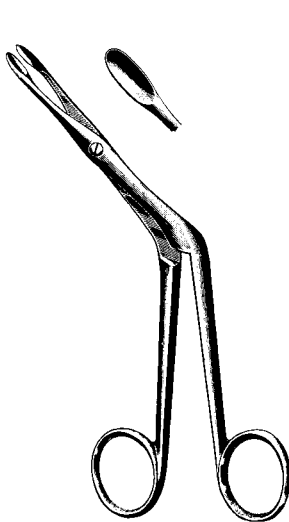
LITTAUER
 47167-18
 18 cm, 7"



HEYMANN-KNIGHT
 47169-18
 18 cm, 7"



NOYES
 47171-14 - 47173-14
 14,5 cm, 5 3/4"



HEYMANN
 47181-18
 18 cm, 7"



KNIGHT
 47185-18
 18 cm, 7"

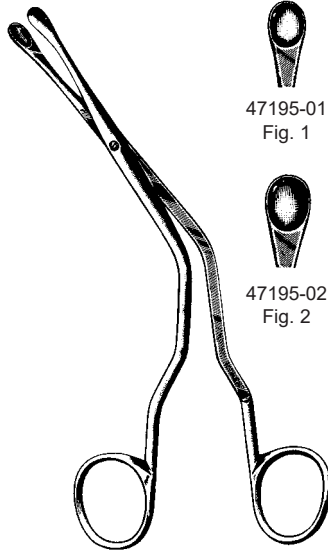


BRUENINGS
 47191-01 - 47191-04
 19 cm, 7 1/2"

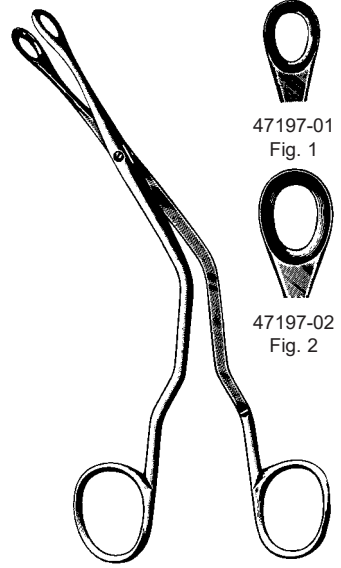
Scharfe Nasenzangen, Septumzangen
 Nasal Cutting Forceps, Septum Forceps
 Pinzas cortantes nasales y para el tabique nasal
 Pinze taglianti nasali, Pinze per il setto nasale



CRAIG
 47192-18
 18 cm, 7"



LUC
 47195-01 - 47195-02
 19 cm, 7 1/2"

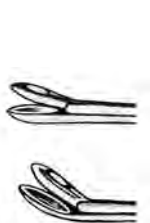








LUC
 47197-01 - 47197-02
 19 cm, 7 1/2"









Fig. 1
 47223-01
 3,0 mm

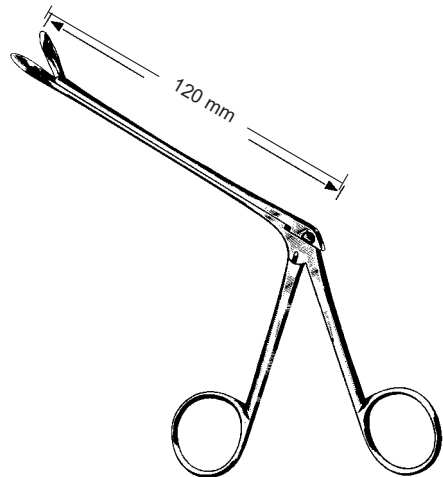
Fig. 2
 47223-02
 3,6 mm



		
Fig. 0 47223-00	Fig. 1 47223-01	Fig. 2 47223-02
2,5 mm	3,0 mm	3,6 mm
		
47224-00	47224-01	47224-02

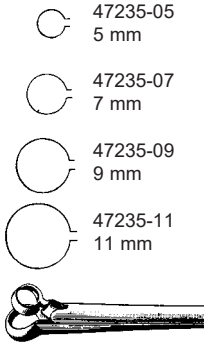


		
Fig. 3 47223-03	Fig. 4 47223-04	Fig. 5 47223-05
4,2 mm	4,8 mm	5,8 mm
		
47224-03	47224-04	47224-05

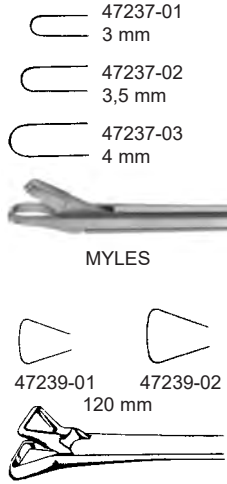


WEIL-BLAKESLEY
 47223-01 - 47224-05

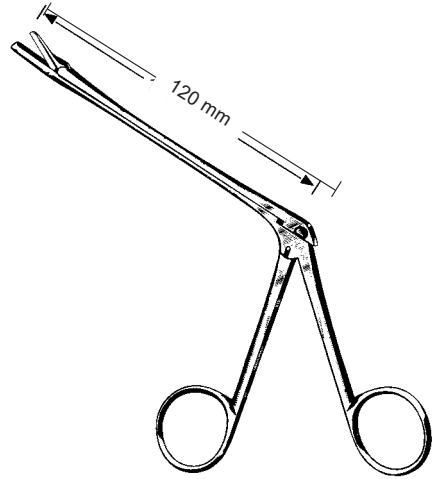
Scharfe Nasenzangen
 Nasal Cutting Forceps
 Pinzas cortantes nasales
 Pinze taglianti nasali



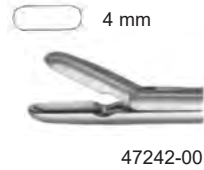
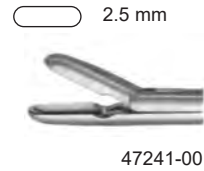
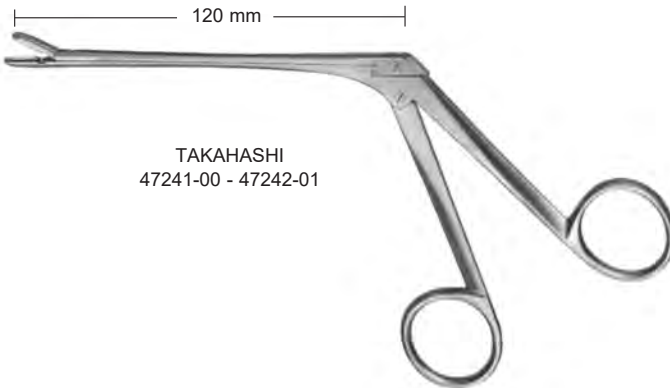
HARTMANN



SCHMEDEN



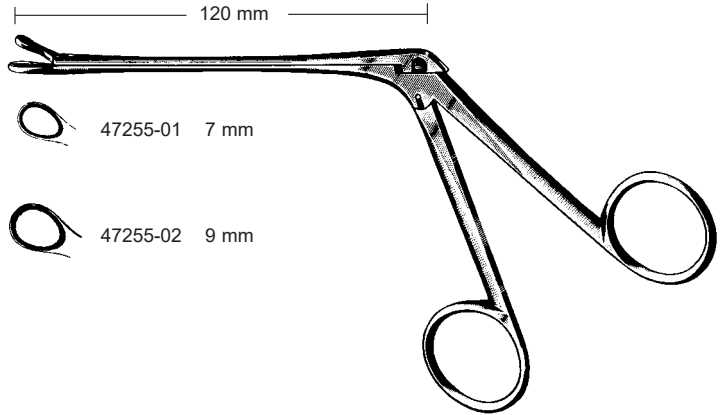
STRUYCKEN
 47240-19
 1.5 mm



Scharfe Nasenzangen, Septumzange, Kieferhöhlenstanze
 Nasal Cutting Forceps, Septum Forceps, Antrum Punch Forceps
 Pinzas cortantes nasales, Pinza para magullar tabique, Pinzas cortantes para maxilares
 Pinze taglianti nasali, Pinza per ammaccare il setto, Pinze taglianti per seno mascellare



RUBIN
 47251-21
 21 cm, 8 1/4"



WATSON-WILLIAMS
 47255-01



CAPLAN
 47256-20
 20 cm, 8"



KERRISON
 3x3 mm 47303-03
 4x4 mm 47303-04
 5x5 mm 47303-05
 6x6 mm 47303-06
 17 cm, 6 3/4"

Kieferhöhlenstanze, Nasenschere
 Antrum Punch Forceps, nasal scissors
 Pinzas cortantes para maxilares, tijera nasal
 Pinze sfenoidali, forbici nasali



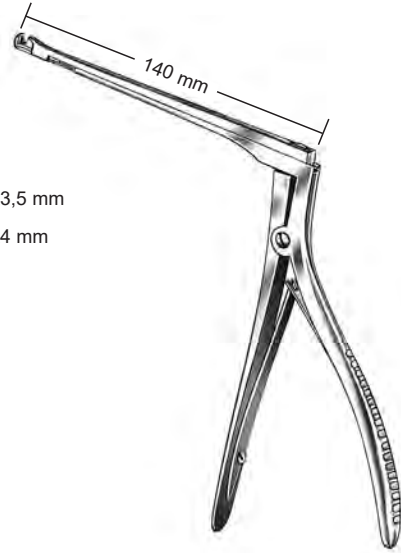
47304-01 5x3,5 mm

47304-03 5x4 mm

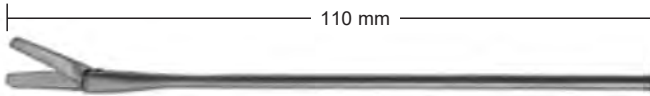


47304-02 5x3,5 mm

47304-04 5x4 mm



HAJEK-KOFLER
 47304-01 - 47304-04



47305-02
 rechts gebogen
 right curved
 curva a la derecha
 curva a destra



47305-03
 links gebogen
 left curved
 curva a la izquierda
 curva a sinistra



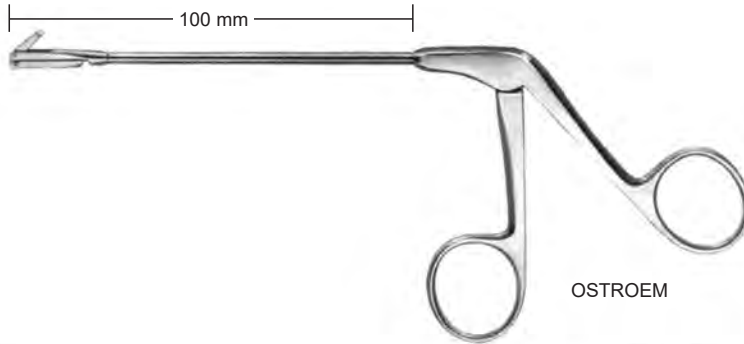
47305-01
 gerade
 straight
 recta
 retta

Knochenstanze, Septumzangen

Punches, Septum Forceps

Pinzas osteótomos, Pinzas para el tabique nasal

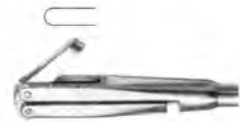
Pinze osteotomi, Pinze per il setto nasale



47315-00
2 mm
oben schneidend
up cutting
cortante por arriba
tagliente in alto



47316-00
2 mm
rechts schneidend
right cutting
cortante a la derecha
tagliente a destra



47317-00
2 mm
links schneidend
left cutting
cortante a la izquierda
tagliente a sinistra



CITELLI
47311-10 1,0 mm
47311-25 2,5 mm
47311-30 3,0 mm



MIDDLETON-JANSEN
47323-19
19 cm, 7 1/2"

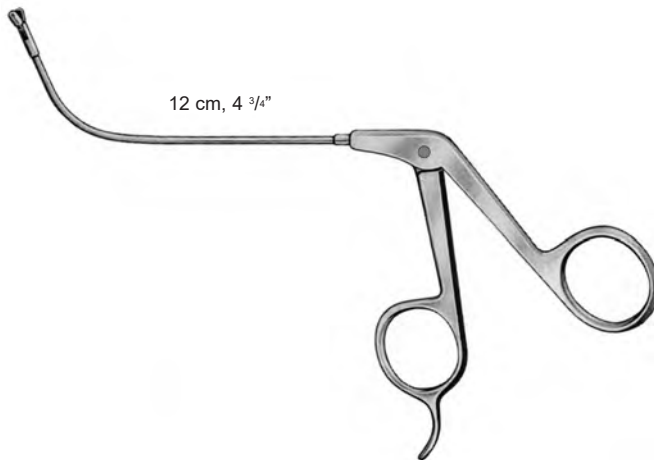


MIDDLETON-JANSEN
47325-19
19 cm, 7 1/2"

Kieferhöhlenstanze, Sinuskopie-Zangen
 Antrum Punch Forceps, Sinuscopy forceps
 Pinzas cortantes para maxilares, Pinzas para senoscopia
 Pinze sfenoidali per seno mascellare, Pinze per sinuscopia



HAJEK-KOFLER
 47316-16
 3,5 mm



12 cm, 4 3/4"

Maul
 jaw
 boca
 morso

horizontal öffnend
 horizontal cutting
 abierta horizontal
 apertura orizzontale

vertikal öffnend
 vertical cutting
 abierta vertical
 apertura verticale

- | | | |
|------|---|-----------|
| 65° | ○ | 3 mm rund |
| 70° | ◌ | } oval |
| 90° | ◌ | |
| 110° | ◌ | |

- | |
|----------|
| 47317-65 |
| 47317-70 |
| 47317-90 |
| 47317-11 |

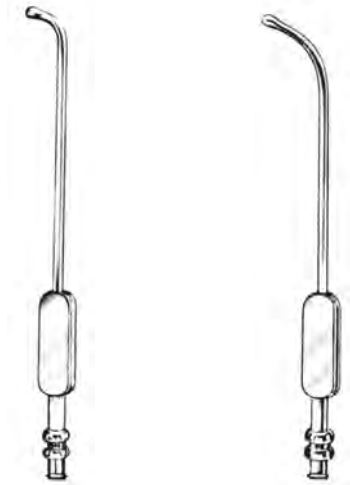
- | |
|----------|
| 47318-65 |
| 47318-70 |
| 47318-90 |
| 47318-11 |

Zirkular Stanze
Circular Forceps
Pinza circular
Pinza circolare



47319-35 3,5 mm
47319-45 4,5 mm

Spülkanülen, Stirnhöhlendilatator
cannulas, Frontal sinus bougies
cánulas, Dilatador para el seno
cannulas, Dilatatore per seno frontale



EICKEN (KILLIAN)

14,5 cm, 5 3/4"

Ø

47331-20	2,0 mm	47332-20
47331-25	2,5 mm	47332-25
47331-30	3,0 mm	47332-30
47331-40	4,0 mm	47332-40



Ø mm RITTER-HALLE

2,5	47342-25
3,0	47342-30
4,0	47342-40

Kiefer- und Stirnhöhlen-Spülkanülen, Saugraspatorium
Antrum and Frontal Sinus Wash Cannulas, Suction Raspatory
Cànulas lavadoras para seno maxilar y seno frontal, Legra de succión
Cannule per seno mascellare e seno frontale, Raspatorio con aspiratore



KILLIAN
Ø 1,5 mm
47345-15



GUILEN
19 cm, 7 1/2"
47347-20

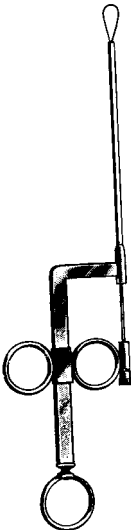
Polypenschnürer
 Nasal Polypus Snares
 Polipótomos
 Serranodi



KRAUSE-VOSS
 47350-26
 26 cm, 10 1/4"



KRAUSE
 47351-26
 26 cm, 10 1/4"



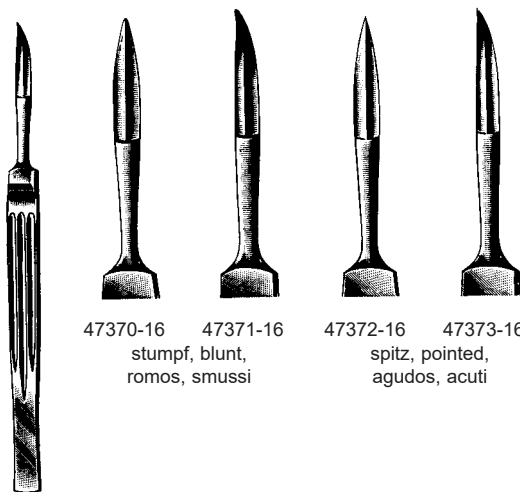
WILDE
 47352-24
 24 cm, 9 1/2"



Bündel mit 12 Stück
 Bundle with 12 pieces
 12 piezas atados
 confezione di 12 pezzi

47355-03 0,3 mm

Nasennmesser
 Nasal Knives
 Bisturies nasales
 Coltelli nasali



47370-16 47371-16
 stumpf, blunt,
 romos, smussi

47372-16 47373-16
 spitz, pointed,
 agudos, acuti

JOSEPH
 47370-16 - 47373-16
 16 cm, 6 1/4"

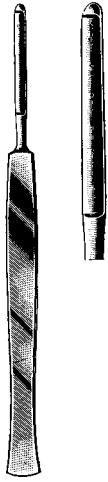


FREER
 47374-16
 16,5 cm, 6 1/2"

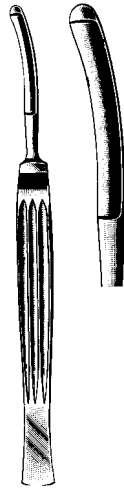


FREER
 47375-19
 19 cm, 7 1/2"

Nasenplastik- und Operationsmesser, Sichelmesser, Küretten
 Rhinoplastic and Nasal Knives, Septum Sickle Knives, Curettes
 Bisturios para plastica y operaciones de la nariz, Bisturios para el tabique nasal, Curetas
 Bisturi per la plastica ed operazioni nasali, coltelli per setto, Curette



JOSEPH
47376-16
16 cm, 6 1/4"



CONVERSE
47379-16
16 cm, 6 1/4"



COTTLE
47380-15
15 cm, 6"



COTTLE
47382-15
15 cm, 6"



JOSEPH
47384-15
15 cm, 6"



JOSEPH
47385-15
15 cm, 6"



REDA
19 cm, 7 1/2"



47386-01
spitz
pointed
agudo
acuto



47386-02
stumpf
blunt
romo
smusso



ANTRUM
19 cm, 7 1/2"



47387-01
vorwärts schneidend
forward cutting
corte hacia adelante
taglio in avanti



47387-02
rückwärts schneidend
backward cutting
corte hacia atras
taglio retrograde

Schwingmesser
 Septum Swivel Knives
 Bisturías para el tabique nasal
 Coltelli per setto



BALLENGER
 47390-03 - 47392-05
 20 cm, 8"



47390-03
 3 mm



47390-04
 4 mm



47390-05
 5 mm



47392-03
 3 mm



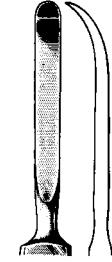
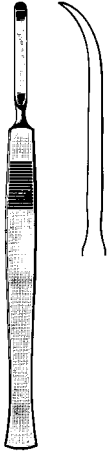
47392-04
 4 mm



47392-05
 5 mm



Septum Elevatoren
Septum Elevators
Elevadores para el tabique
Elevatori per setto



47410-04
4 mm



47410-05
5 mm

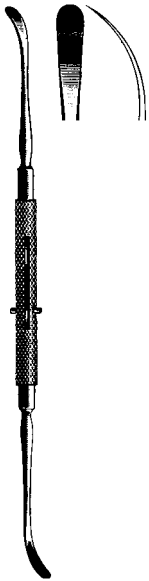


HALLE
47410-16
16.5 cm, 6 1/2"



JOSEPH
47411-16
16 cm, 6 1/4"

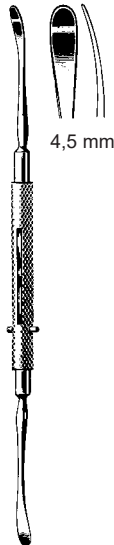
McKENTY
47410-04 - 47410-05
15 cm, 6"



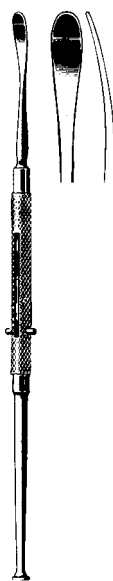
ROGER
47413-19
19 cm, 7 1/2"



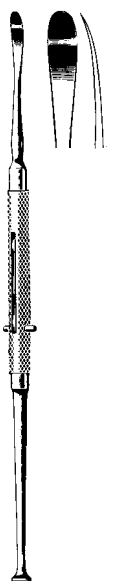
MASING
47414-21
22 cm, 8 3/4"



FREER
47415-18
18 cm, 7"



FREER
47417-19
19 cm, 7 1/2"



FREER
47419-19
19 cm, 7 1/2"

Septum Elevatoren
 Septum Elevators
 Elevadores para el tabique
 Elevatori per setto



KILLIAN
 47420-01
 18,5 cm, 7 1/4"



PIERCE
 47420-02
 21 cm, 8 1/4"



SINUS
 47420-03
 18 cm, 7"



PENNINGTON
 47420-04
 21 cm, 8 1/4"



McKENTY
 47420-20
 22 cm, 8 3/4"

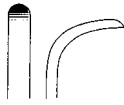


HOWARTH
 47421-21
 21,5 cm, 8 1/2"

Septum Elevatoren
 Septum Elevators
 Elevadores para el tabique
 Elevatori per setto



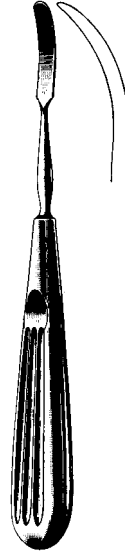
COTTLE
 47421-23
 23 cm, 9"



COTTLE JOSEPH
 47422-22
 22 cm, 8 3/4"



COTTLE
 47423-22
 22 cm, 8 3/4"



COTTLE
 47424-16
 16 cm, 6 1/4"



COTTLE
 47425-19
 19 cm, 7 1/2"



KILLIAN
 47426-22
 22 cm, 8 3/4"



HAJEK-BALLENGER
 47428-21
 22 cm, 8 3/4"



BALLENGER
 47430-22
 22 cm, 8 3/4"

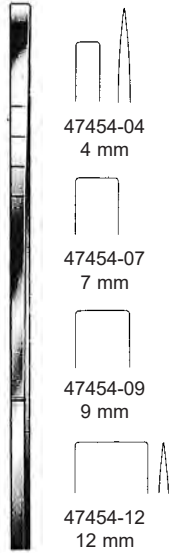


FREER
 47450-04
 15 cm, 6"



FREER
 47451-04
 15 cm, 6"

Osteotome, Knorpelquetscher
 Osteotomes, Cartilage crusher
 Osteótomos, Macha cadera
 Osteotomi, Tritacartilagine



47454-04
4 mm

47454-07
7 mm

47454-09
9 mm

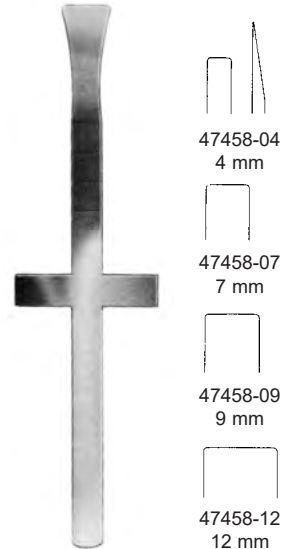
47454-12
12 mm

COTTLE
47454-04 - 47454-12
18 cm, 7"



6 mm

COTTLE
47455-06
18 cm, 7"



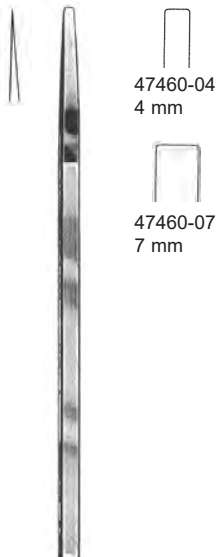
47458-04
4 mm

47458-07
7 mm

47458-09
9 mm

47458-12
12 mm

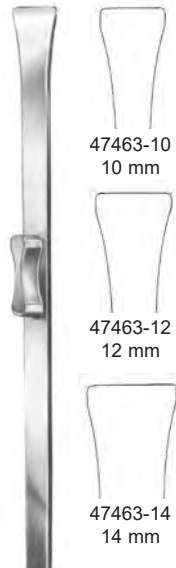
COTTLE
47458-04 - 47458-12
18 cm, 7"



47460-04
4 mm

47460-07
7 mm

COTTLE
18 cm, 7"



47463-10
10 mm

47463-12
12 mm

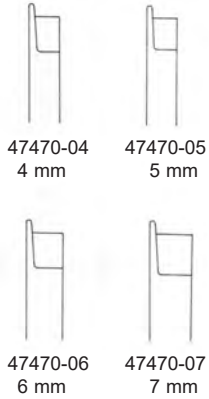
47463-14
14 mm

RUBIN
18,5 cm, 7 1/4"

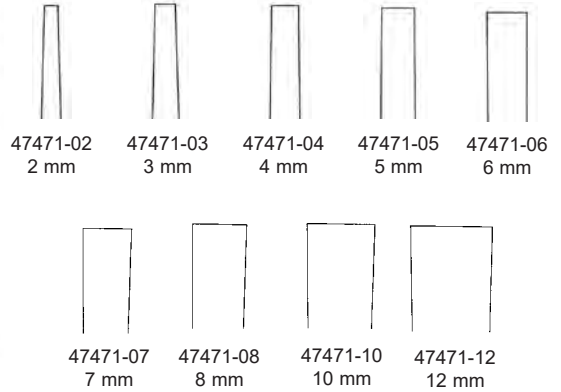


COTTLE
Knorpelquetscher
47461-00

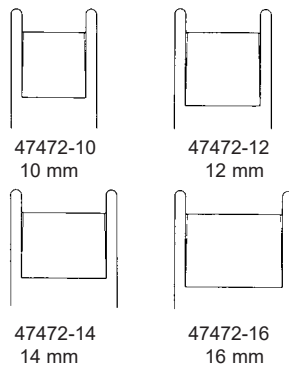
Osteotome, Septum Meißel
 Osteotomes, Rhinoplastic Chisels
 Osteótomos, Cinceles para la plàstica nasal
 Osteotomi, Scalpelli per plastica nasale



FOMON
 47470-04 - 47470-07
 17 cm, 6 3/4"

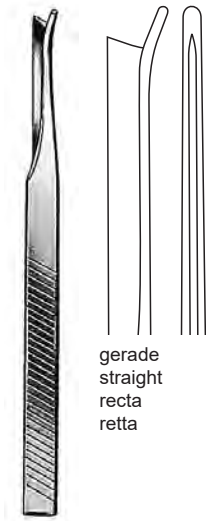


SHEEHAN
 47471-07 - 47471-12
 16 cm, 6 3/4"



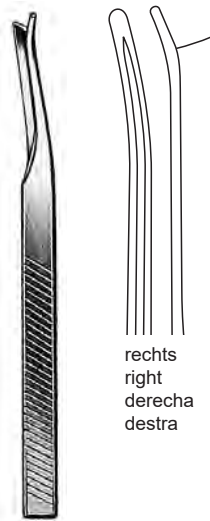
CINELLI
 47472-10 - 47472-16
 16 cm, 6 1/4"

Septum Meißel, Osteotom
 Rhinoplastic Chisels, Osteotom
 Cinceles para la plástica nasal, Osteotom
 Scalpelli per plastica nasale, Osteotom



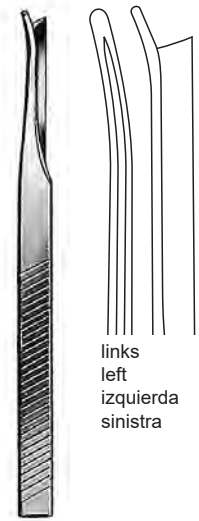
gerade
 straight
 recta
 retta

SILVER
 47473-01
 18 cm, 7"



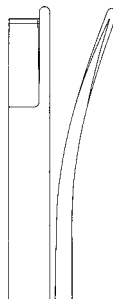
rechts
 right
 derecha
 destra

SILVER
 47473-02
 18 cm, 7"

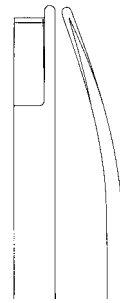


links
 left
 izquierda
 sinistra

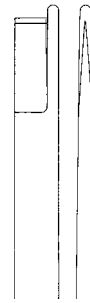
SILVER
 47473-03
 18 cm, 7"



47474-01
 rechts
 right
 derecha
 destra



47474-02
 links
 left
 izquierda
 sinistra



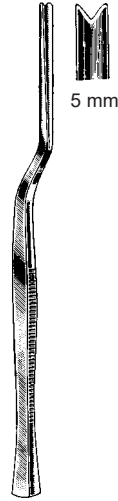
47474-03
 gerade
 straight
 recta
 retta

NEIVERT-ANDERSON
 47474-01 - 47474-03
 20,5 cm, 8" 7 mm

Septum-Hohlmeißel, Osteotom
 Septum Gouges, Osteotom
 Gubias para tabique nasal, Osteótom
 Sgorbie per il setto nasale, Osteotom



KILLIAN
 47481-05
 16 cm, 6 1/4"



KILLIAN-CLAUS
 47482-05
 17 cm, 6 3/4"



mm HAJEK
 4 47484-04
 6 47484-06
 8 47484-08
 16 cm, 6 1/4"



WEST
 47486-16
 16 cm, 6 1/4"

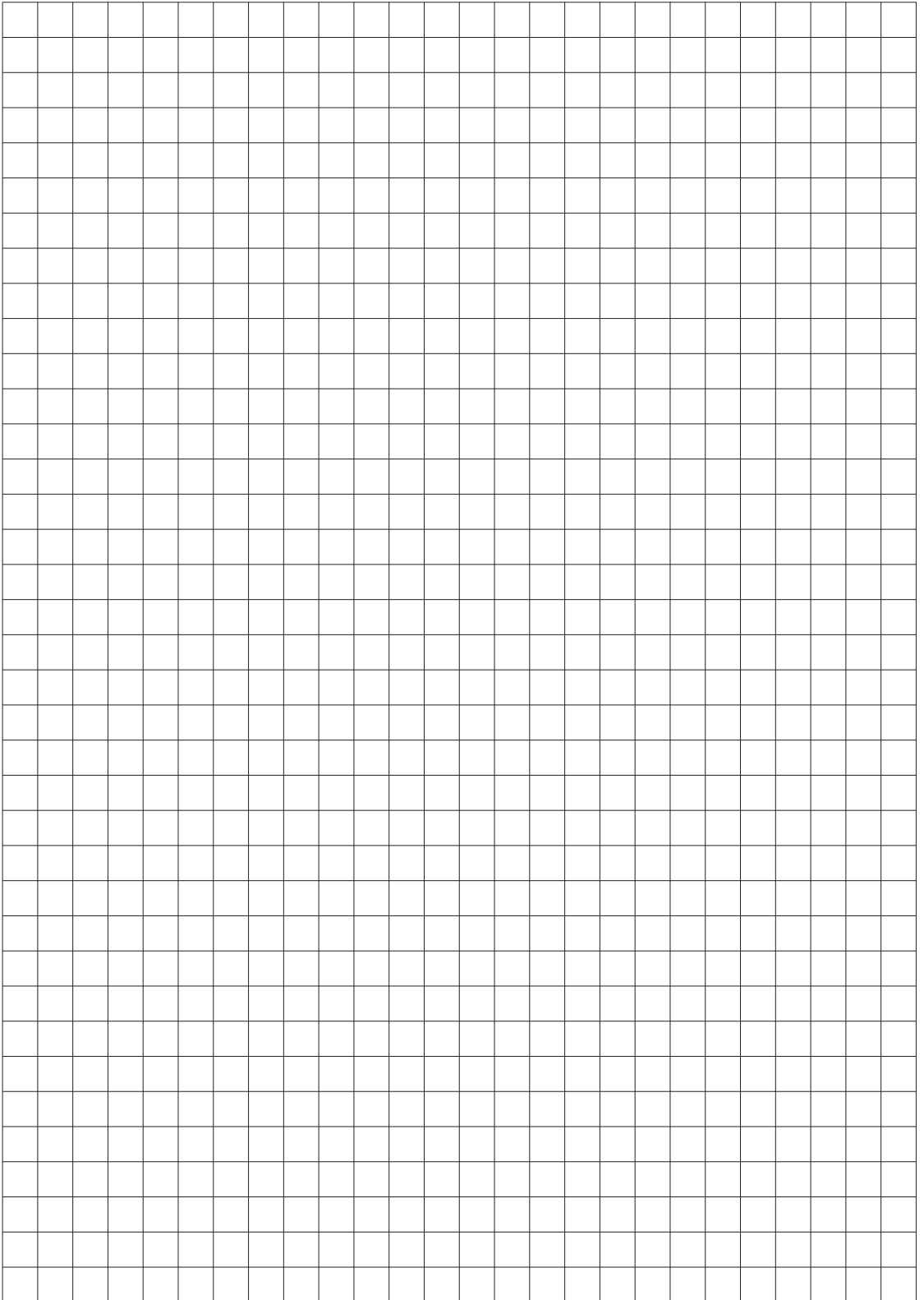


WEST
 47487-16
 16 cm, 6 1/4"

6 mm



FREER
 47489-16
 16 cm, 6 1/4"



Knochenfeile, Nasenraspeln
Bone File, Nasal Rasps
Limas para hueso, Escofinas nasales
Lime per ossa, Raspa nasale



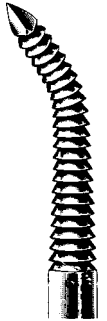
JOSEPH
47502-16
16 cm, 6 1/4"



MALTZ
47504-18
18 cm, 7"



WIENER
47507-17 - 47507-19
18 cm, 7"



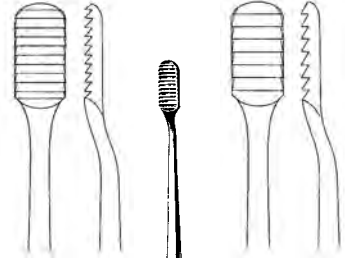
47507-17



47507-19



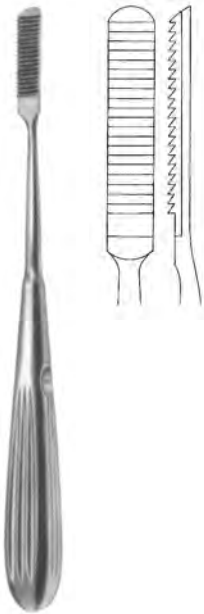
AUFRICHT
47511-21 21 cm, 8 1/4" 47513-21



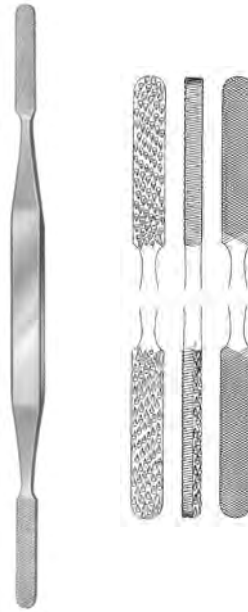
JOSEPH (LEWIS)
47514-16 18 cm, 7" 47516-16



Nasenraspeln
 Nasal Rasps
 Escofinas nasales
 Raspa nasale



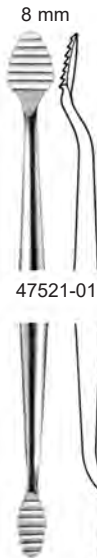
MALTZ (COTTLE)
 47518-21
 21 cm, 8 1/4"



FOMON
 47520-21
 21 cm, 8 1/4"



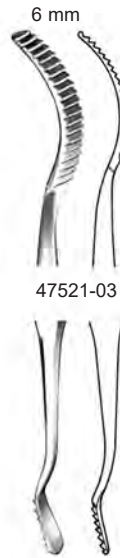
MILLER
 18 cm, 7"



8 mm
 47521-01
 5 mm

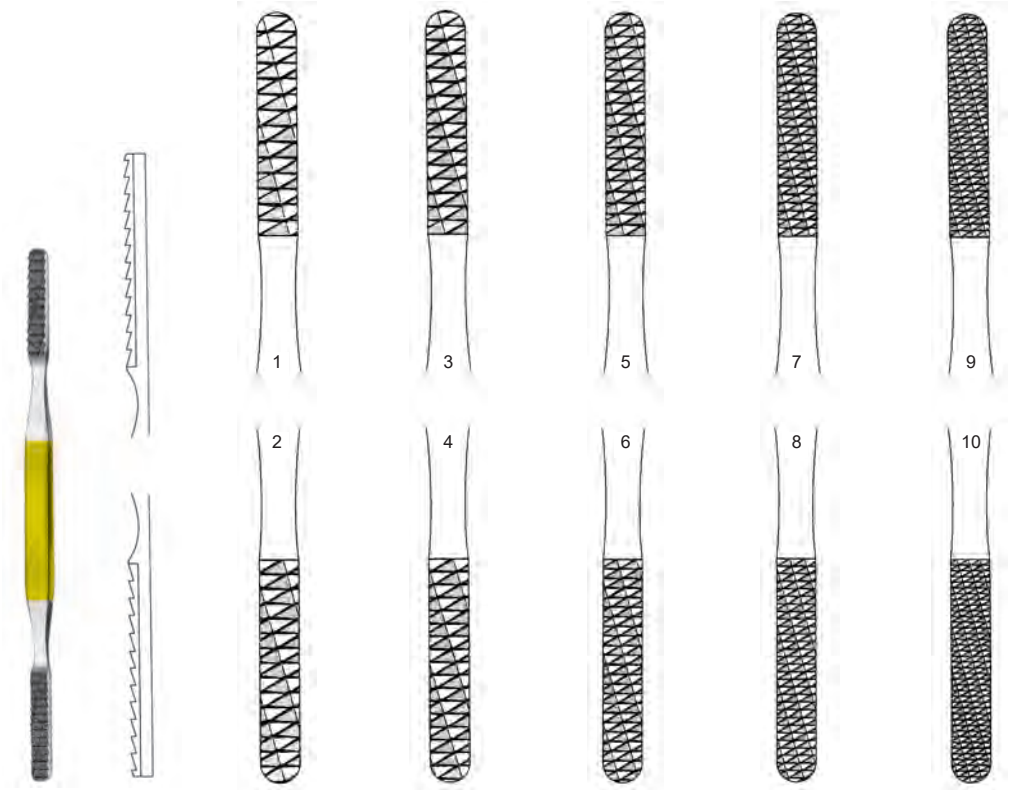


6 mm
 47521-02
 4,3 mm



6 mm
 47521-03
 5 mm

Nasenraspeln
Nasal Rasps
Escofinas nasales
Raspa nasale



FOMON
47522-01 - 47522-09 TC
20 cm, 8"

Fig. 1/2
47522-01 TC

Fig. 3/4
47522-04 TC

Fig. 5/6
47522-05 TC

Fig. 7/8
47522-07 TC

Fig. 9/10
47522-09 TC

Nasenraspeln, Nasensägen
 Nasal Rasps, Nasal Saws
 Escofinas nasales, Sierras nasales
 Raspa nasale, Seghe nasale



PEET
 47523-01 —
 47523-02 —
 19 cm, 7 1/2"



GALLAHER
 47526-16 - 47529-16
 16 cm, 6 1/4"



Fig. 1
 47526-16



Fig. 2
 47527-16

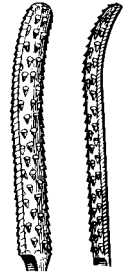


Fig. 3
 47529-16



JOSEPH
 19 cm, 7 1/2"



47533-19

gerade
 straight
 recta
 retta



47532-19

links
 left
 izquierda
 sinistra



47534-19

rechts
 right
 derecha
 destra

Nasenhaken
 Nasal retractor
 Retractores nasales
 Retrattori nasali



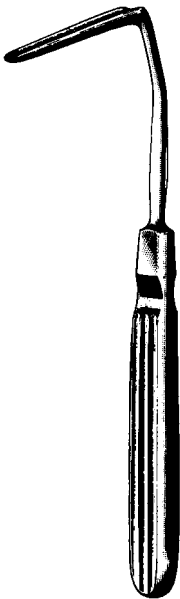
COTTLE
 47540-16
 16 cm, 6 1/4"



MASING
 47541-14
 14 cm, 5 1/2"



AUFRICHT
 47542-12
 12 cm, 4 3/4"



AUFRICHT
 47551-16
 16 cm, 6 1/4"



AUFRICHT
 47551-16CL
 16 cm, 6 1/4"



MASING-NEIVERT
 47552-16
 16 cm, 6 1/4"

Nasenhaken, Hauthäkchen
 Nasal retractor
 Retractores nasales, Ganchos para la piel
 Retrattori nasali, uncini nasali

10 x 12 mm



COTTLE
 47553-15
 15 cm, 6"



COTTLE
 14,5 cm, 5 3/4"



47554-01



47554-02

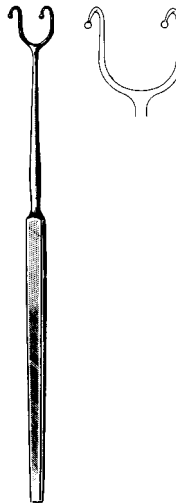


47554-03

3 x 11 mm



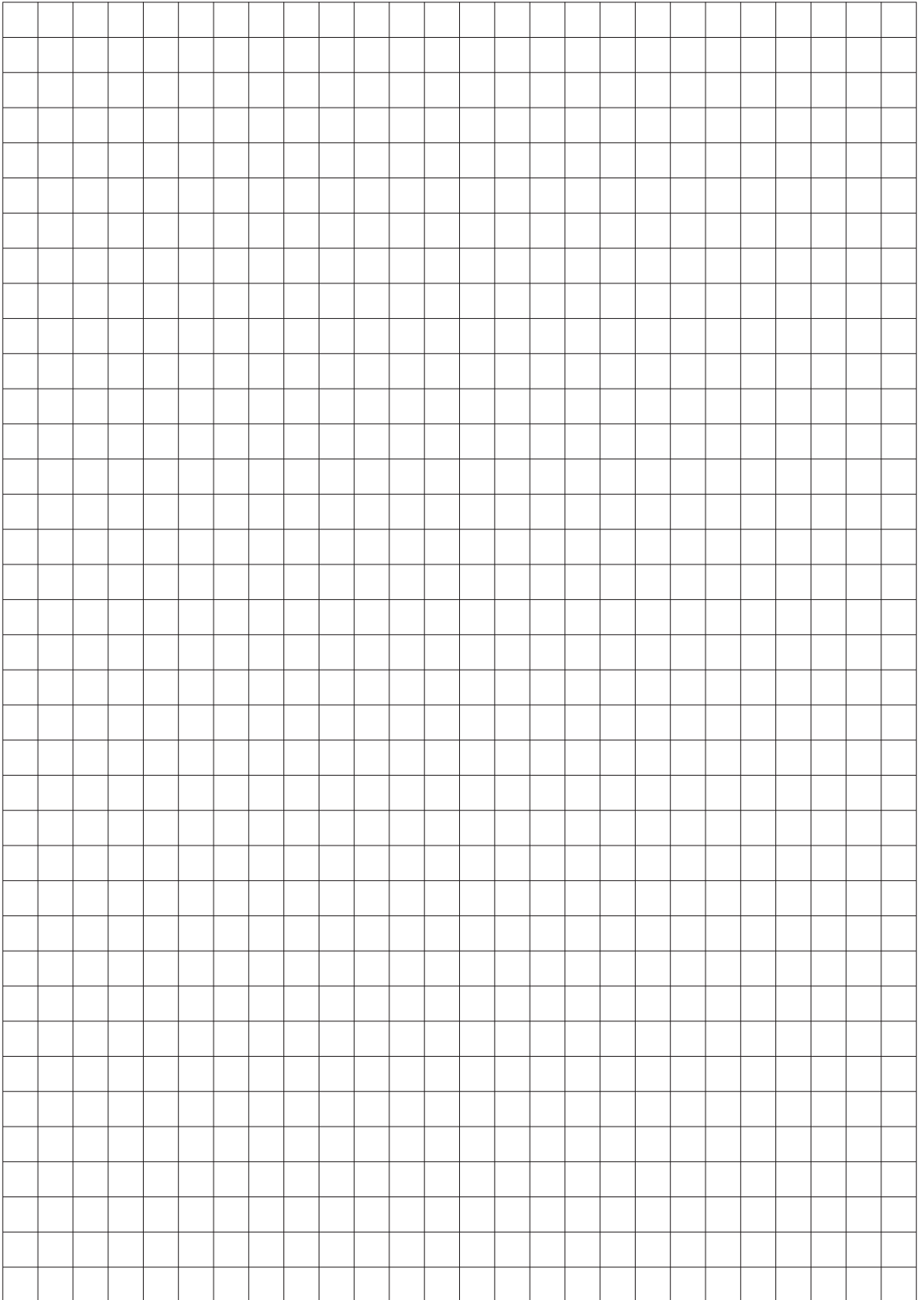
KILNER
 47555-08
 8 cm, 3 1/8"



FOMON
 47556-16
 16 cm, 6 1/4"



FOMON
 47557-17
 17 cm, 6 3/4"



Hauthäkchen, Columella Pinzette
 Retractor, Columnella forceps
 Ganchos para la piel, Pinza para columnela
 Uncini, Pinzetta columella



FREER
 47558-15
 15 cm, 6"



COTTLE-NEIVERT
 47559-20
 20 cm, 8"



Fig. 1
 47560-18



Fig. 2
 47562-18

GILLIES
 18 cm, 7"



LANGE
 47563-22
 23 cm, 9"



COTTLE
 47564-16
 16 cm, 6 1/4"



COTTLE
 47565-10
 10 cm, 4"



CONVERSE
 47566-12
 12 cm, 4 3/4"

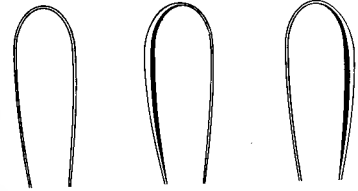
Septumrichtzangen, Küretten
 Septum Straightening Forceps, Curettes
 Pinza para enderezar el tabique nasal, curetas
 Pinza per la plastica nasale, Curette



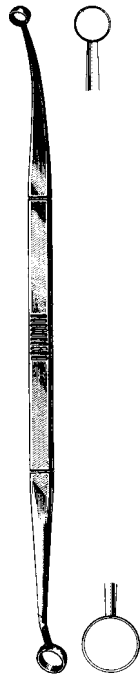
ASCH
 47571-23
 23 cm, 9"



WALSHAM
 47572-23 - 47575-23
 23 cm, 9"



47572-23 gerade straight recta retta	47573-23 links left izquierda a sinistra	47575-23 rechts right derecha a destra
--	--	--



FAULKNER
 47601-21
 21 cm, 8 1/4"



COAKLEY
 47607-01 - 47607-06
 17 cm, 6 3/4"

5,5 mm



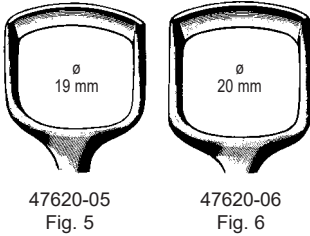
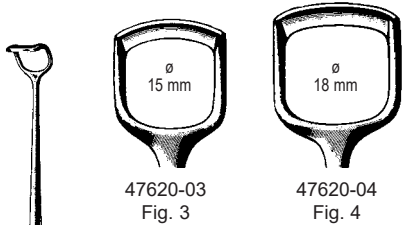
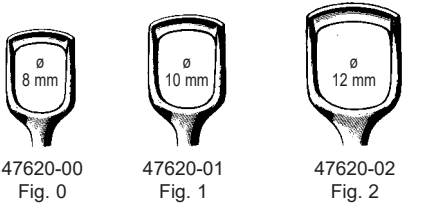
47607-01 Fig. 1	47607-02 Fig. 2	47607-03 Fig. 3
--------------------	--------------------	--------------------

7,0 mm



47607-04 Fig. 4	47607-05 Fig. 5	47607-06 Fig. 6
--------------------	--------------------	--------------------

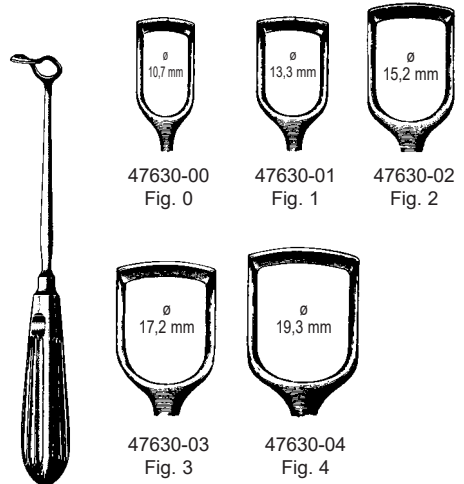
Ringmesser
 Adenoid Currettes
 Cuchillos para vegetaciones adenoides
 Coltelli per vegetazioni adenoide



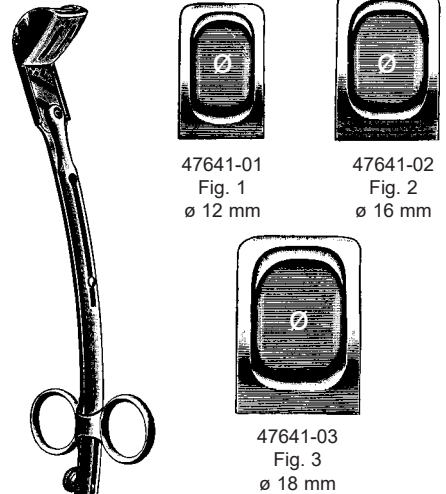
BECKMANN
 47620-01 - 47620-06
 22 cm, 8 3/4"



St. CLAIR-THOMSON
 47636-01 - 47636-04
 21 cm, 8 1/4"



BARNHILL
 47630-01 - 47630-04
 21 cm, 8 1/4"



Ersatzklingen allein, gelocht
 Spare blades, perforated
 Hojas de repuesto, perforadas
 Lame di ricambio, forate

Fig. 1 47642-01
 Fig. 2 47642-02
 Fig. 3 47642-03

LAFORCE
 47641-01 - 47641-03
 25 cm, 10"

Zungenspatel, Wangen- und Lippenhalter
 Tongue Depressors, Cheek and Lip Retractors
 Baja-lenguas, Separadores para labios y mejillas
 Abbassalingua, Divaricatori per guance e labbra

Holz
 wood
 madera
 legno



49102-16
 16 cm, 6 1/4"
 Pack. à 100

21,7 mm



MAYO
 49103-17
 17 cm, 6 3/4"

21,4 mm

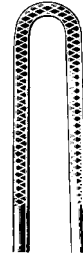


KROENIG
 49104-15
 15 cm, 6"

23 mm



FRENZEL
 49105-16
 16,5 cm, 6 1/2"



13 mm

16 mm



49106-01
 14,5 cm, 5 3/4"

15 mm



49106-02
 14,5 cm, 5 3/4"

15 mm



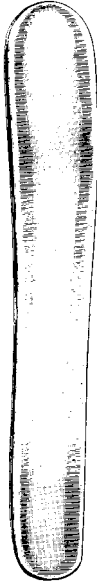
BRUENINGS
 49107-19
 19 cm, 7 1/2"

20 mm



CAWOOD-MINNESOTA
 49108-15
 15 cm, 6"

23 mm



BUCHWALD
 49109-19
 19 cm, 7 1/2"



DOYEN



49119-01
 13 cm / 5 1/8"

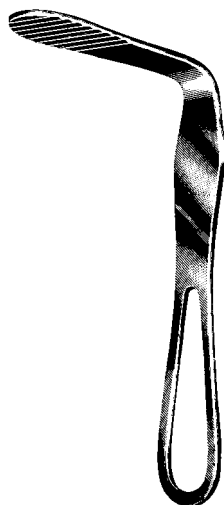


49119-02
 16 cm, 6 1/4"

Zungendrucker
Tongue Depressors
Baja-lenguas
Abassalingua



MORITZ-SCHMIDT
49110-19
19 cm, 7 1/2"



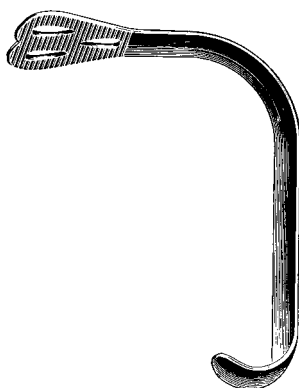
HARTMANN
49111-15
15 cm, 6"



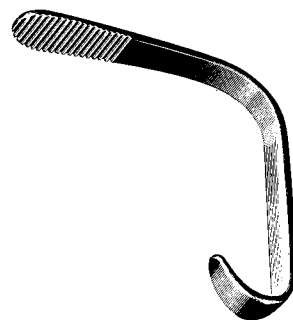
49115-01
Fig. 1
14 cm, 5 1/2"



49115-02
Fig. 2
15 cm, 6"

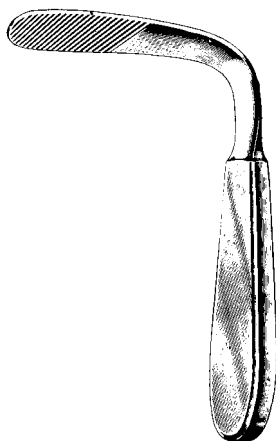


WIEDER
49115-01 - 49115-02

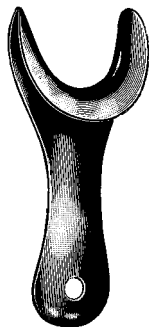


ANDREW
49117-11
11 cm, 4 3/8"

Zungendrucker, Wangen- und Lippenhalter, Zungenzangen
 Tongue Depressor, Cheek and Lip Retractor, Tongue Holding Forceps
 Baja-lenguas, Separadores para labios y mejillas, Pinza tira-lenguas
 Abassalingua, Divaricatori per guance e labbra, Pinza tiralingua



TOBOLD
 49119-14
 14,5 cm, 5 3/4"



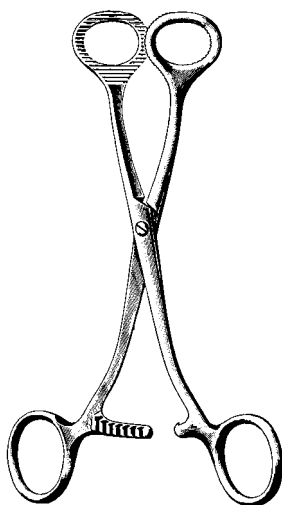
49230-11
 11 cm, 4 3/8"



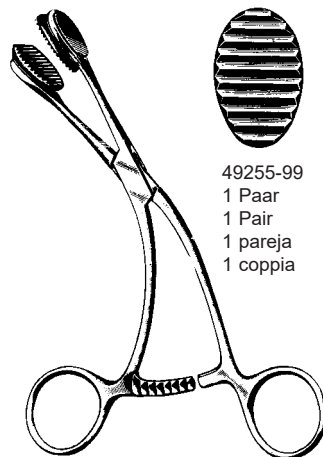
STERNBERG
 49231-12 12 cm, 4 3/4"
 49231-14 14 cm, 5 1/2"
 49231-16 16 cm, 6 1/4"



49235-19
 19 cm, 7 1/2"

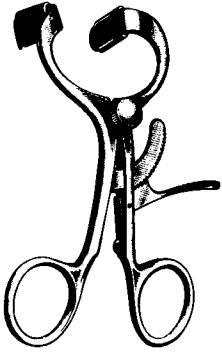


COLLIN
 49250-16 16 cm, 6 1/4"
 49250-18 18 cm, 7"

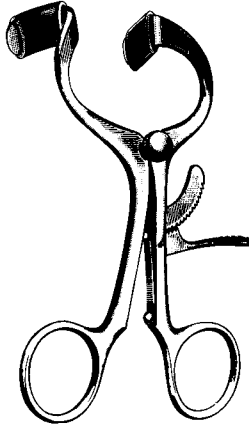


49255-99
 1 Paar
 1 Pair
 1 pareja
 1 coppia
 YOUNG
 49255-16
 16 cm, 6 1/4"

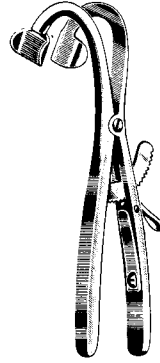
Mundsperrer
 Mouth Gags
 Abre-Bocas
 Apribocca



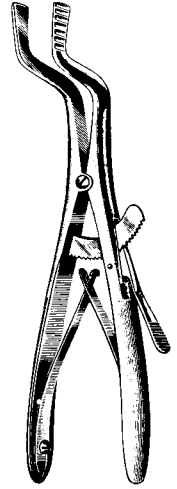
DOYEN-JANSEN (MOLT)
 49265-12
 12 cm, 4 3/4"



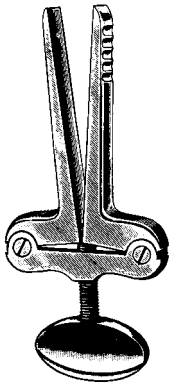
DOYEN-JANSEN (MOLT)
 49265-14
 14 cm, 5 1/2"



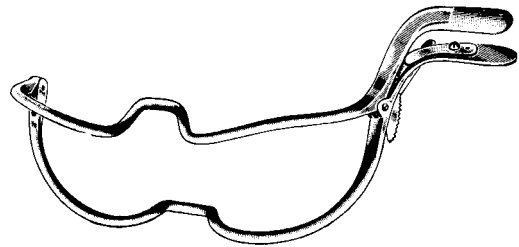
DENHART
 49267-12
 12 cm, 4 3/4"



ROSER-KOENIG
 49270-16 16 cm, 6 1/4"
 49270-19 19 cm, 7 1/2"

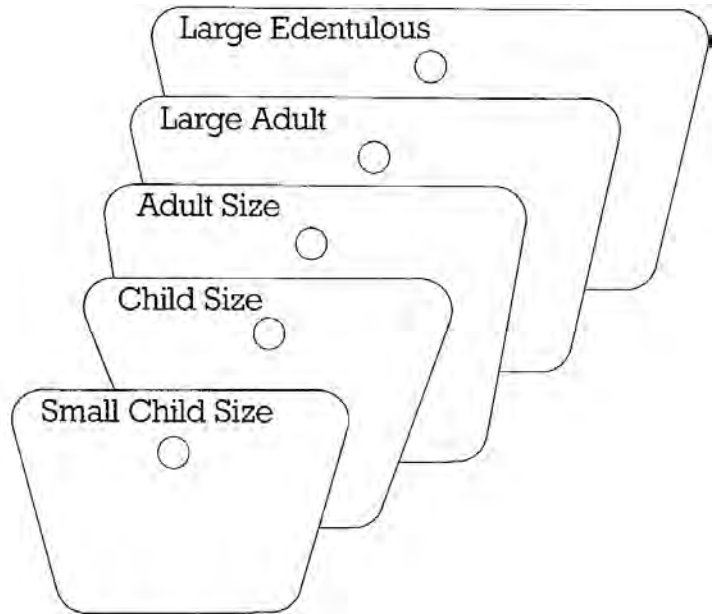


HEISTER
 49272-13
 13 cm, 5 1/8"



JENNINGS
 49274-09 9 cm, 3 1/2"
 49274-11 11 cm, 4 3/8"
 49274-13 13 cm, 5 1/8"
 49274-15 15 cm, 6"

Metallrahmen
Metal frame
Cuadro metálico
Telaio metallico



McKESSON

kunststoffbeschichteter Metallrahmen
ohne Kette

plastic coated metal frame
without chain

cuadro metálico, cubierto de plástico
sin cadena

telaio metallico, ricoperto in plastica
senza catena

49275-01

groß, für Erwachsene
large, for adults
grande, para adultos
grande, per adulti

49275-04

normal, für Erwachsene
regular, for adults
regular, para adultos
regolare, per adulti

49275-02

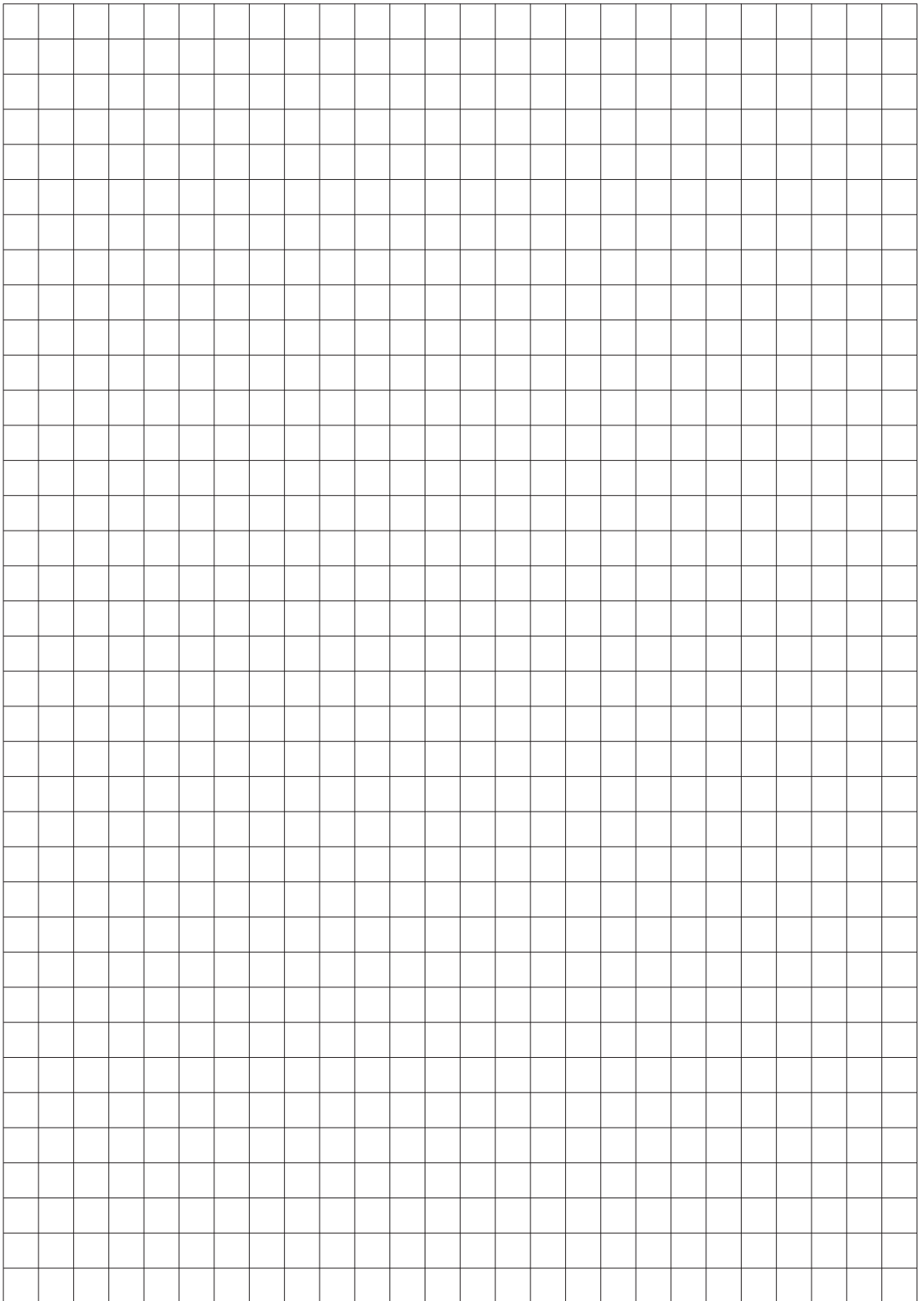
klein, für Kinder
small, for children
pequeño, para niños
piccolo, per bambini

49275-05

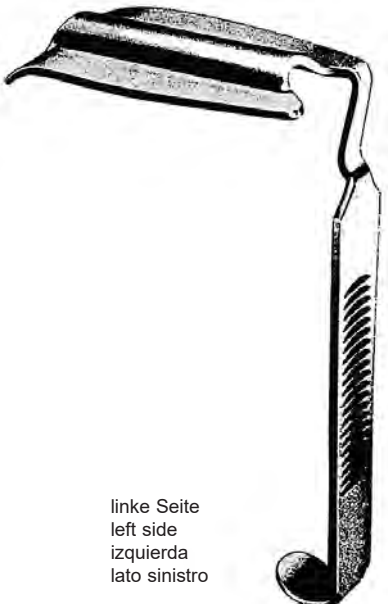
klein, für Kleinkinder
small, for babies
pequeño, para bebés
piccolo, per neonati

49275-03

extra groß, für Zahnlose
extra large, for edentulous
muy grande, para desdentados
molto grande, per sdentati



Zungenspatel, Mundsperrer
 Tongue depressor, Mouth Gags
 Baja-lengua, Abrebocas
 Abbassalingua, Apribocca

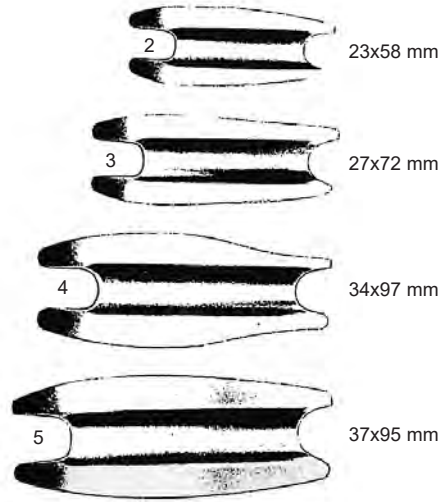


linke Seite
 left side
 izquierda
 lato sinistro

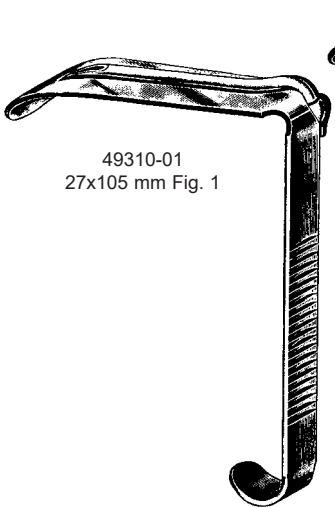
rechte Seite
 right side
 derecha
 lato destro

RING

- 49287-02 Fig. 2 49288-02
- 49287-03 Fig. 3 49288-03
- 49287-04 Fig. 4 49288-04
- 49287-05 Fig. 5 49288-05



- 2 23x58 mm
- 3 27x72 mm
- 4 34x97 mm
- 5 37x95 mm



49310-01
 27x105 mm Fig. 1

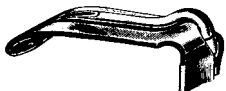
DAVIS-BOYLE
 49310-00
 compl.



49310-02
 25x90 mm Fig. 2



49310-03
 25x75 mm Fig. 3

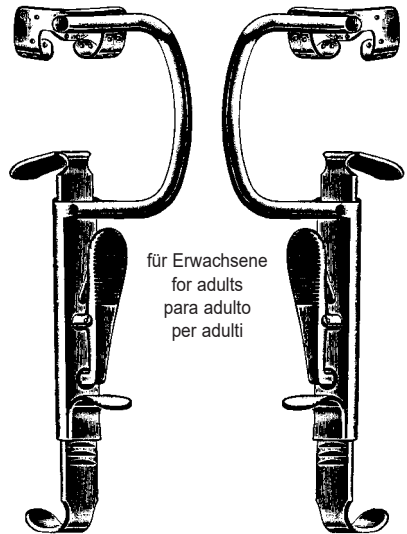


49310-04
 22x60 mm Fig. 4



49310-05
 20x25 mm Fig. 5

49310-08 Silikoneinlagen/Silicone pads
 inserto de silicona/inserto in silicone

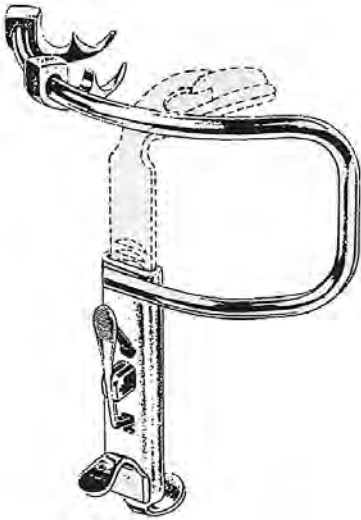


für Erwachsene
 for adults
 para adulto
 per adulti

49310-10
 Sperrer allein, links
 Gag only, left
 Abre-boca suelta, izquierda
 Apribocca solo, sinistra

49310-12
 Sperrer allein, rechts
 Gag only, right
 Abre-boca suelta, derecha
 Apribocca solo, destra

Mundsperrer
Mouth Gags
Abre-Bocas
Apribocca



49315-10
Sperrer allein
Gag only
Abre-boca solo
Apribocca solo



49315-01
37 x 80 mm
Fig. 1



49315-02
32 x 75 mm
Fig. 2



49315-03
28 x 65 mm
Fig. 3

KILNER-DOUGHTY

49315-00
komplett
complete
completo

49317-00 DINGMANN, complete
mit 3 auswechselbaren Zungendrucker,
2 seitliche Wangenhaken und 2 Zahnhaken

with 3 interchangeable tongue depressors,
2 rotating cheek holders
2 movable tooth hooks and thread guide

con 3 baja lenguas intercambiables,
2 valvas giratorias p. los labios,
2 ganchos graduables

con 3 depressori intercambiabili,
2 valve laterali rotative
2 uncini a denti mobile



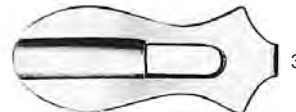
DINGMANN
49317-10
Sperrer allein, Gag only
Abre-boca solo, Apribocca solo



1 24x62 mm
49317-01



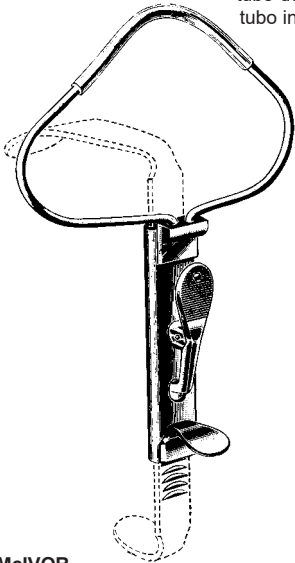
2 28x65 mm
49317-02



3 31x75 mm
49317-03

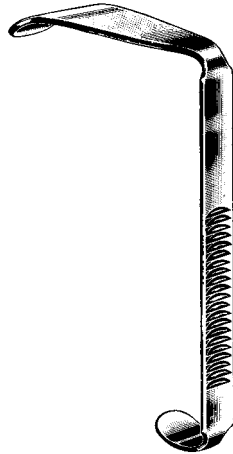
Mundsperrer
Mouth Gag
Abre-bocas
Apribocca

49320-20
Silikon-Schlauch
Silicon Tubing
tubo de silicona
tubo in silicone



McIVOR
49320-00
compl.

49320-10



49320-01
27x95 mm Fig. 1



49320-02
22x85 mm Fig. 2

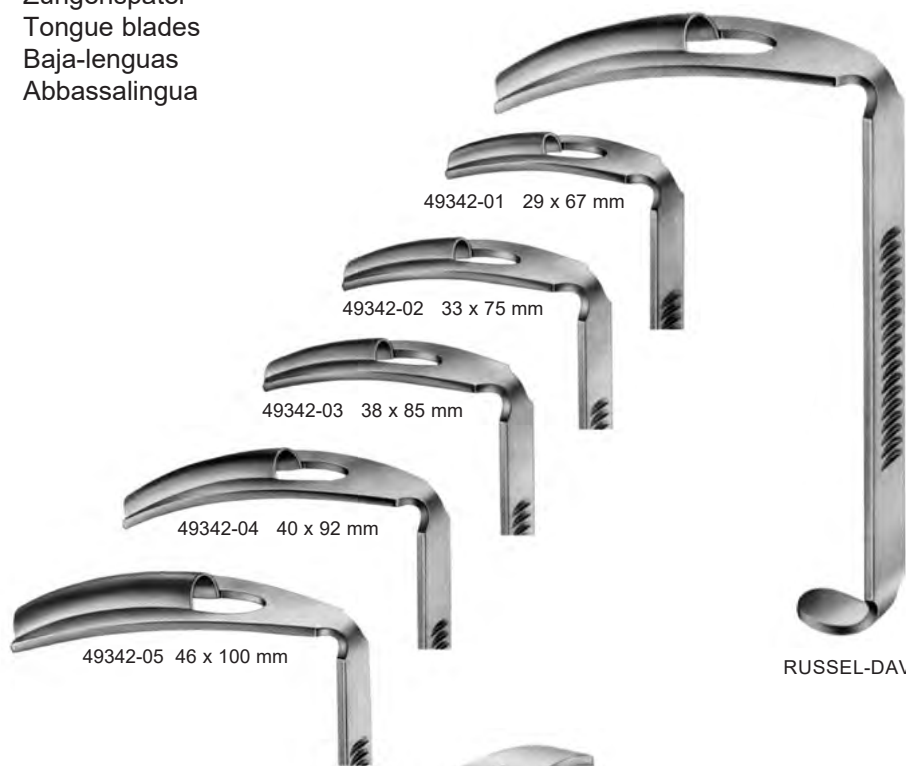


49320-03
22x70 mm Fig. 3

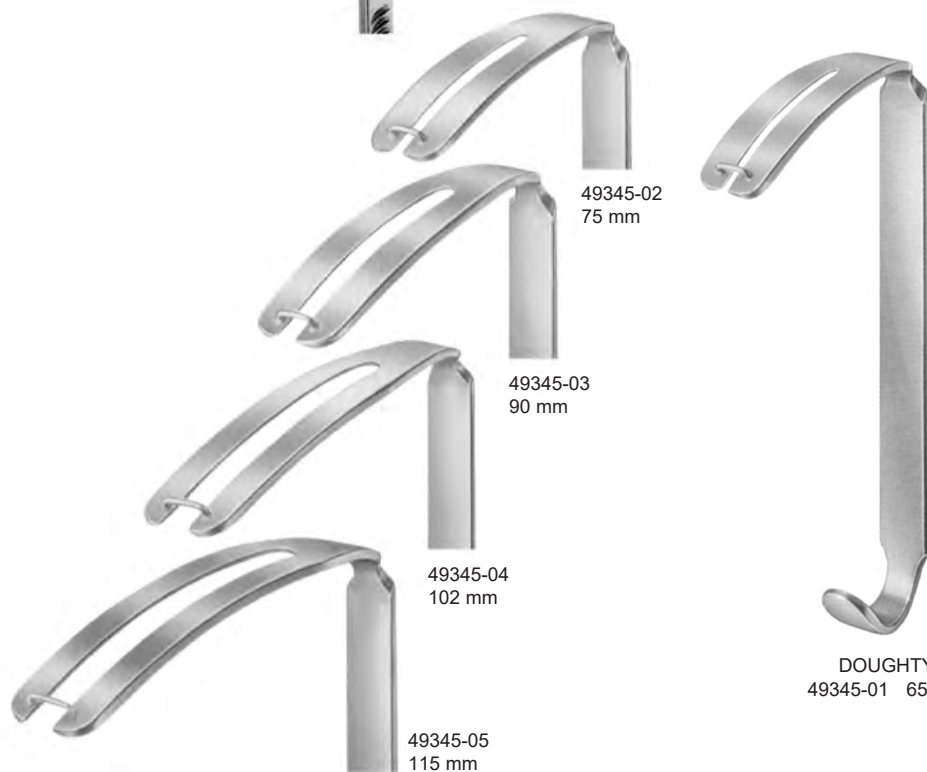


DAVIS-MEYER
49340-00

Zungenspatel
Tongue blades
Baja-lenguas
Abbassalingua



RUSSEL-DAVIS

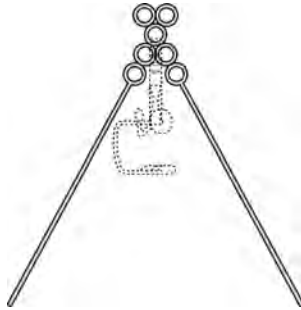


DOUGHTY
49345-01 65 mm

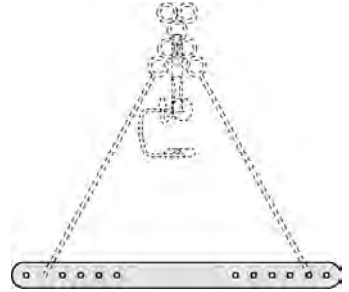
Mundkeil, Bruststütze, Repositionszange
 Oral wedges, Chest support, Disimpaction forceps
 Abreboca, Soporte de pecho, Pinzas para reposiciones
 Apribocca, Supporto per petto, Pinze per riposizione



NEGUS
49400-01



DRAFFIN
49350-01



MAGAURAN
49350-02



links
left side
izquierda
lato sinistro



rechts
right side
derecha
lato destro

Holz
wood
madera
legno



MAUNDER
49360-10

ROWE
49501-22 22,5 cm, 8.9"
49501-23 23,5 cm, 9 1/4"
49501-24 24,0 cm, 9 1/2"

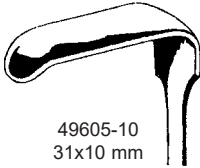
Baby, baby, bebé, lattante
Kind, child, niño, bambino
Erwachs., adult, adulto

ROWE
49503-22 22,5 cm, 8.9"
49503-23 23,5 cm, 9 1/4"
49503-24 24,0 cm, 9 1/2"

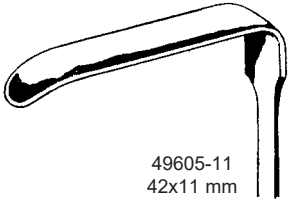
Wundhaken für Mund-Kiefer-Gesicht
 Retractors for Mouth-, Jaw- and Face Surgery
 Separadores para cirugía plástica
 Divaricatori per chirurgia plastica



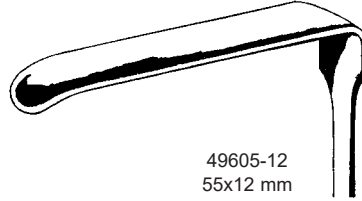
49605-07
25x7 mm



49605-10
31x10 mm



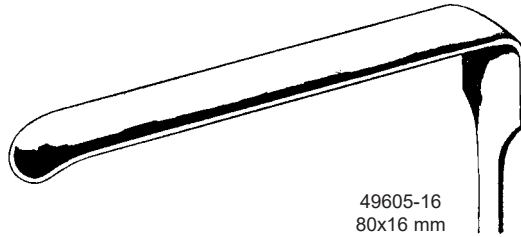
49605-11
42x11 mm



49605-12
55x12 mm



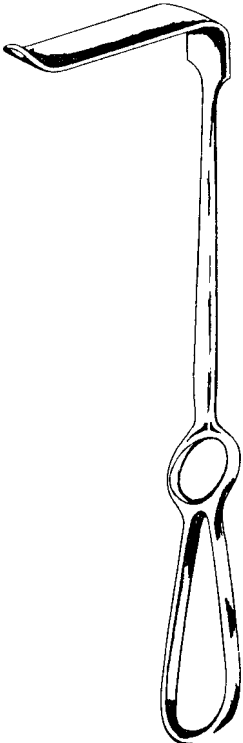
49605-14
70x14 mm



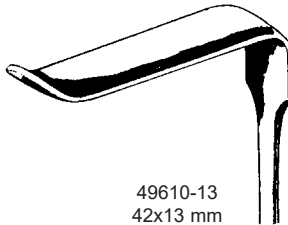
49605-16
80x16 mm



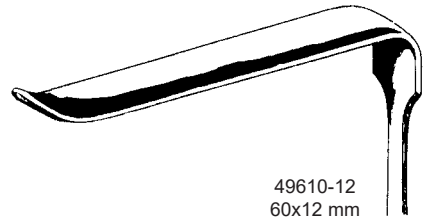
OBWEGESER
49605-07 - 49605-16
22 cm, 8 3/4"



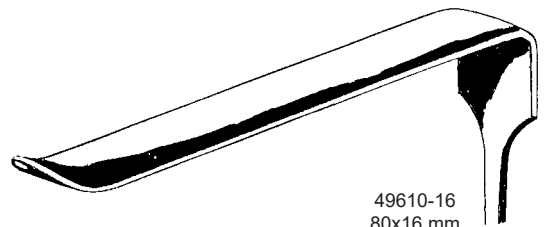
OBWEGESER
49610-12 - 49610-16
22 cm, 8 3/4"



49610-13
42x13 mm

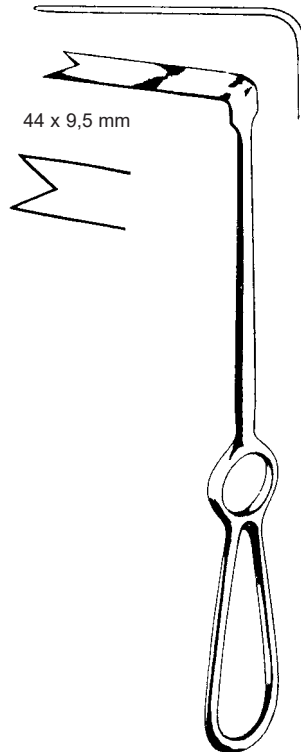


49610-12
60x12 mm



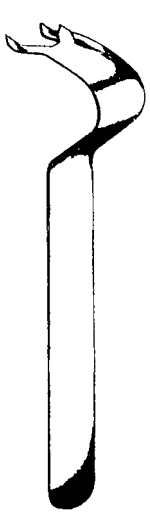
49610-16
80x16 mm

Wundhaken für Mund-Kiefer-Gesicht
Retractors for Mouth-, Jaw- and Face Surgery
Separadores para cirugía plástica
Divaricatori per chirurgia plastica

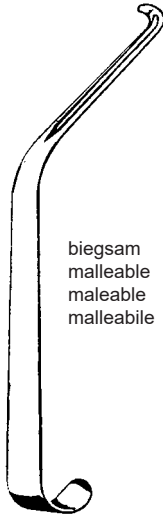


SPINA-NASALIS
49613-10
22 cm, 8 3/4"

Wundhaken für Mund-Kiefer-Gesicht, Raspatorien
 Retractors for Mouth-, Jaw- and Face Surgery, Periosteal Elevators
 Separadores para cirugía plástica, Periostótomos
 Divaricatori per chirurgia plastica, Periostotomi

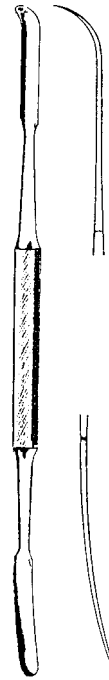


OBWEGESER
 49620-15
 15,5 cm, 6"

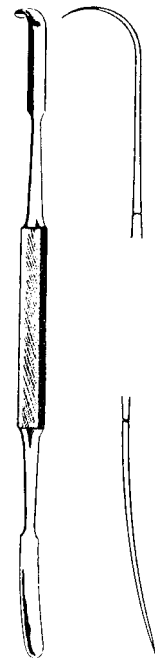


biegsam
 malleable
 maleable
 malleabile

OBWEGESER
 16 cm, 6 1/4"
 49624-10 8 mm
 49623-16 10 mm

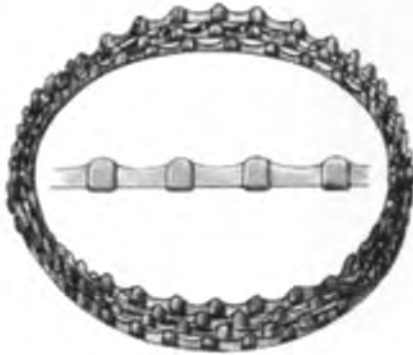


OBWEGESER
 49627-01
 21 cm, 8 1/4"



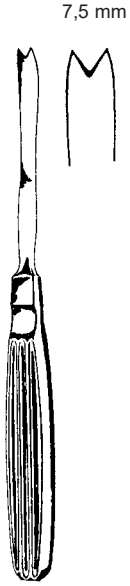
OBWEGESER
 49630-02
 20,5 cm, 8"

Drahtbogen
Wire Pushers
Empujadores de alambres
Posizionatori per filo



ERICH
49631-00
20,5 cm, 8"

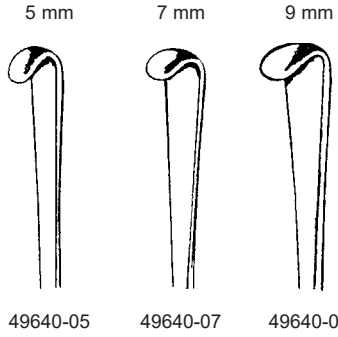
Raspatorien
 Periosteal Elevators
 Periostótomos
 Periostotomi



OBWEGESER
 49635-18
 17,5 cm, 7"



OBWEGESER
 49640-05 - 49640-09
 20 cm, 8"



49640-05 49640-07 49640-09



OBWEGESER
 49650-06 - 49650-11
 17,5 cm, 7"



49650-06



49650-07

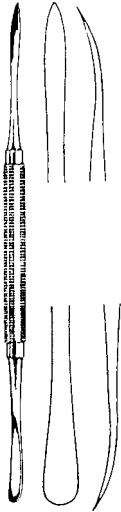


49650-09



49650-11

Elevator, Osteotom, Ahle
 Elevator, Osteotome, Awls
 Elevadores, Osteotomos, Agujas
 Elevatori, Osteotomo, Aghi



DINGMAN
 49660-18
 18 cm, 7"



OBWEGESER
 49665-24
 23,5 cm, 9 1/4"



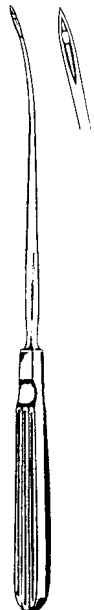
HARGIS
 49670-19
 19 cm, 7 1/2"

Vorderrandstripper
 Anterior Border Stripper
 Separador para el borde anterior
 Separatore per il bordo anteriore



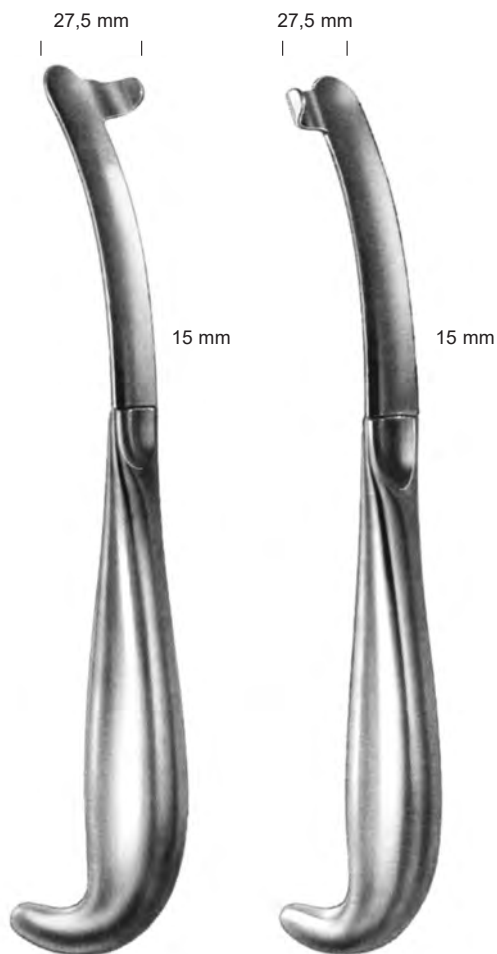
SMITH
 49670-20
 23,5 cm, 9 1/4"

Spreizzange
 Ramus Separator
 Pinza para separar la rama
 Pinza per separare il ramo



OBWEGESER
 49670-23
 23 cm, 9"

Intraorale Retraktoren
Intra Oral Retractors
Separadores intra orales
Retrattori intraorali



49671-01
21 cm, 8 1/4"
rechts
right
droite
destra

49671-02
21 cm, 8 1/4"
links
left
gauche
sinistra

Raspatorien
 Periosteal Elevators
 Legras
 Elevatori per periostio



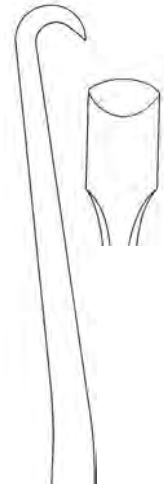
HARGIS
 23 cm, 9"



49673-01
 6,5 mm
 rechts
 right
 derecha
 destra



49673-02
 9 mm
 rechts
 right
 derecha
 destra



49673-03
 6,5 mm
 links
 left
 izquierda
 sinistra



49673-04
 9 mm
 links
 left
 izquierda
 sinistra

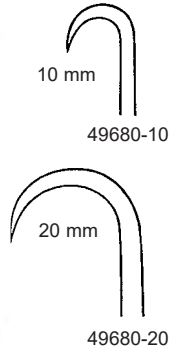
Ahle, Haken, Elevator
 Awls, Retractors for Mouth-, Jaw- and Face Surgery
 Agujas, Separadores para cirugía plástica
 Aghi, Divaricatori per chirurgia plastica



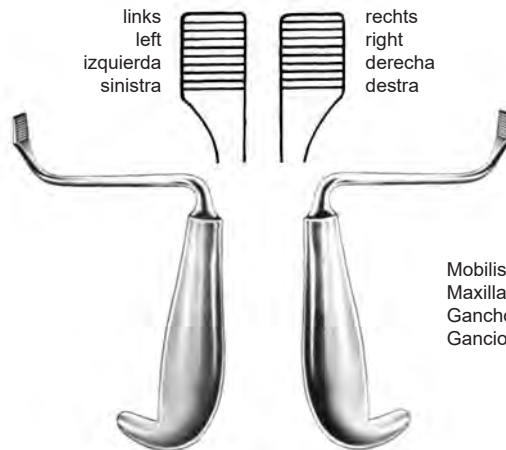
OBWEGESER
 49675-18
 18 cm, 7"



19 cm, 7 1/2"



DINGMAN
 49685-21
 21 cm, 8 1/4"

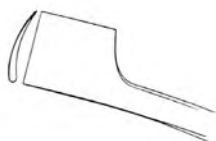


TESSIER
 49691-15 15 cm, 6"

TESSIER
 49692-15 15 cm, 6"

Mobilisierhaken
 Maxillary Mobilizer
 Gancho para movilización
 Gancio per mobilizzare

Sagittalspreizer
Sagittal Split Separators
Separadores sagitales
Separatori sagittali



rechts
right
derecha
destra

SMITH
49695-01
18,5 cm, 7 1/4"
9 mm



links
left
izquierda
sinistra

SMITH
49695-02
18,5 cm, 7 1/4"
9 mm

Unterkieferkörperhaken
Mandibular Body Retractor
Separador para el cuerpo mandibular
Separatore per il corpo mandibolare



HARGIS
49696-18
18 cm, 7"

Osteotome
Osteotome
Osteótomos
Osteotomi

7 mm



49700-01
21,5 cm, 8 1/2"

10 mm



49700-02
21,5 cm, 8 1/2"

Blattosteotom
Blade Osteotomes
Osteótomos de hoja
Osteotomo a lama



OBWEGESER
22 cm, 8 3/4"



49705-08
8 mm



49705-12
12 mm



49705-16
16 mm

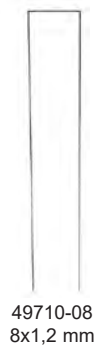
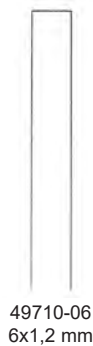
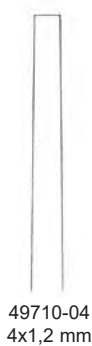


49705-20
20 mm

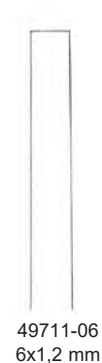
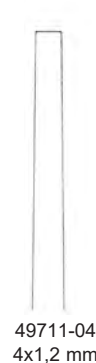
Osteotome
 Osteotome
 Osteótomos
 Osteotomi



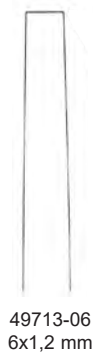
EPKER
 18 cm, 7"



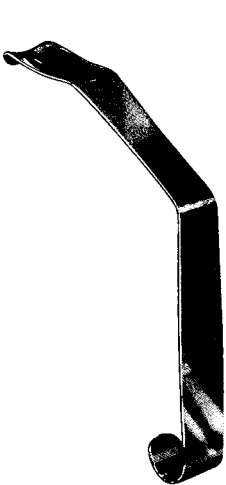
EPKER
 18 cm, 7"



EPKER
 18 cm, 7"



Wundhaken, Tonsillen-Elevatoren, Tamponstopfer
 Retractors, Tonsil-Elevators, Gauze packer
 Separadores, Elevadores para amígdalas, Tamponeador
 Divaricatori, Elevatori, Tamponatore



LOVE
 15 cm, 6"
 51103-18 18 mm
 51103-20 20 mm
 51103-22 22 mm



HOFER
 51109-24
 24 cm, 9 1/2"



NAGER
 51111-23
 23 cm, 9"



HURD
 51131-22
 22 cm, 8 1/4"



LOPEZ-REINKE
 51133-23
 23 cm, 9"



GWYNNE EVANS
 20 cm, 8"
 51112-06 6 mm
 51112-08 8 mm



51135-01



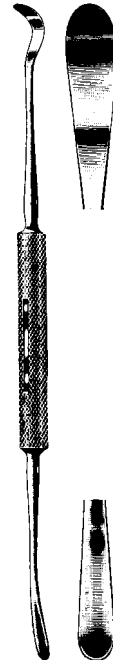
51135-02



HENKE
 23 cm, 9"



CARPENTER
 51139-25
 25 cm, 10"



CARPENTER
 51143-24
 24 cm, 9 1/2"



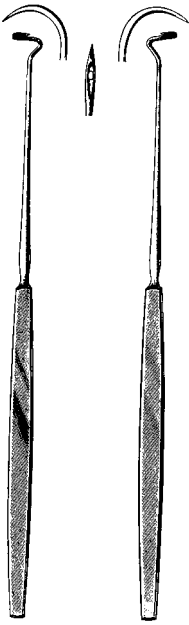
LUNIATSCHEK
 51151-19
 19 cm, 7 1/2"

Tonsillen-Nadeln, Tonsillen-Messer

Tonsil Needles, Tonsil-Knives

Agujas para suturas de amígdalas, Bisturios para amígdalas

Aghi per tonsille, Coltelli per tonsille



DUPUY-WEISS
51165-22 51167-22
22 cm, 8 3/4"



CLAUS
51168-23
23 cm, 9"



CLAUS-EICKEN
51169-23
23 cm, 9"



NAGER
51170-24
24 cm, 9 1/2"



FISHER
51171-22
22,5 , 9"



ABRAHAM
51172-19
19 cm, 7 1/2"



ABRAHAM
51173-21
21 cm, 8 1/4"

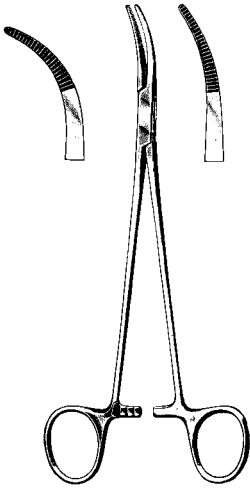


CANFIELD
51174-21
21 cm, 8 1/4"

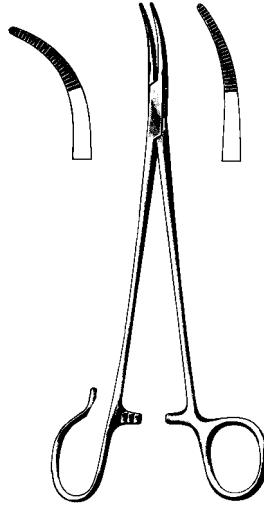


BRUENINGS
51177-23
23 cm, 9"

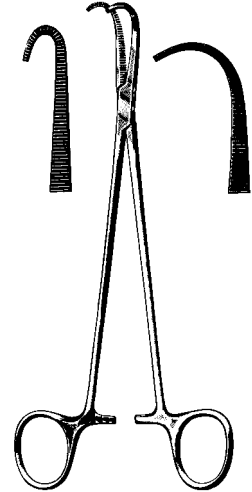
Tonsillenzange
Tonsil Seizing Forceps
Pinzas para coger las amígdalas
Pinze per tonsille



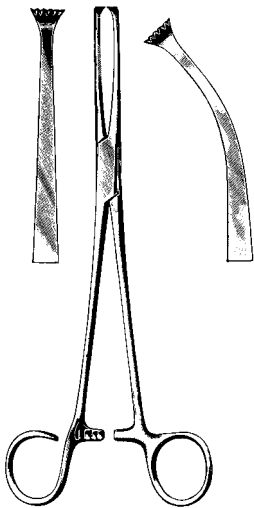
19 cm, 7 1/2"
SAWTELL SCHNIDT
51181-19 51183-19



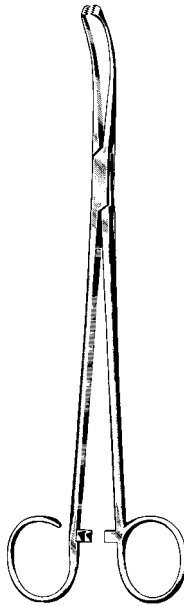
19 cm, 7 1/2"
SAWTELL SCHNIDT
51185-19 51187-19



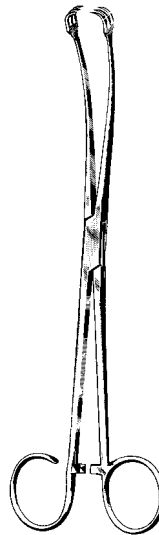
19 cm, 7 1/2"
NEGUS NEGUS
51191-19 51193-19



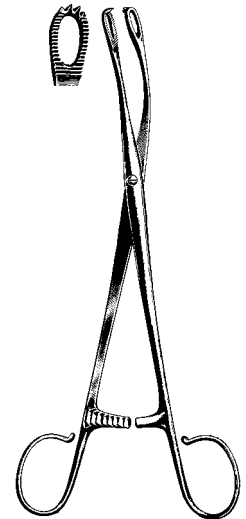
19 cm, 7 1/2"
COLVER
51202-19 51203-19



WHITE
51205-18 18 cm, 7"
51205-23 23 cm, 9"



BALLENGER
51207-21
21,5 cm, 8 1/2"

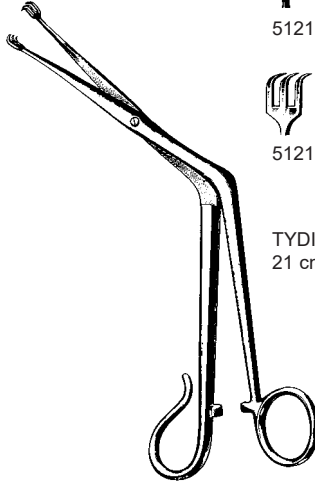


BLOHMKE
51209-20
20 cm, 8"

Tonsillen-Zangen u. -Pinzetten, Tonsillen-Kompressoren, Tonsillen-Schnürer
 Tonsil-Forceps, Tonsil-Snares
 Pinzas, Compresores para amígdalas, Cierra-nudos para amígdalas
 Pinze, Compresori per tonsille, Serranodi per tonsille



ABRAHAM
 51210-20
 20 cm, 8"

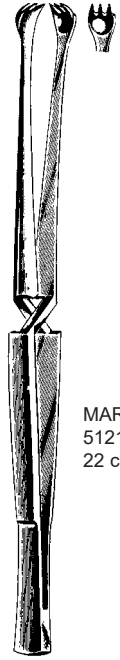


51211-21



51213-21

TYDING
 21 cm, 8 1/4"



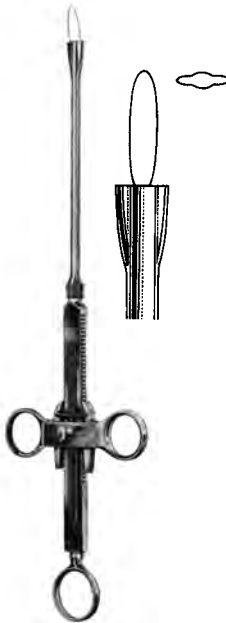
MARSCHIK
 51219-22
 22 cm, 8 3/4"



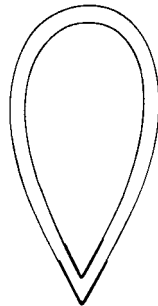
EVES
 51250-28
 28 cm, 11"



EVES
 51252-28
 28 cm, 11"



BRUENINGS
 51256-28
 28 cm, 11"

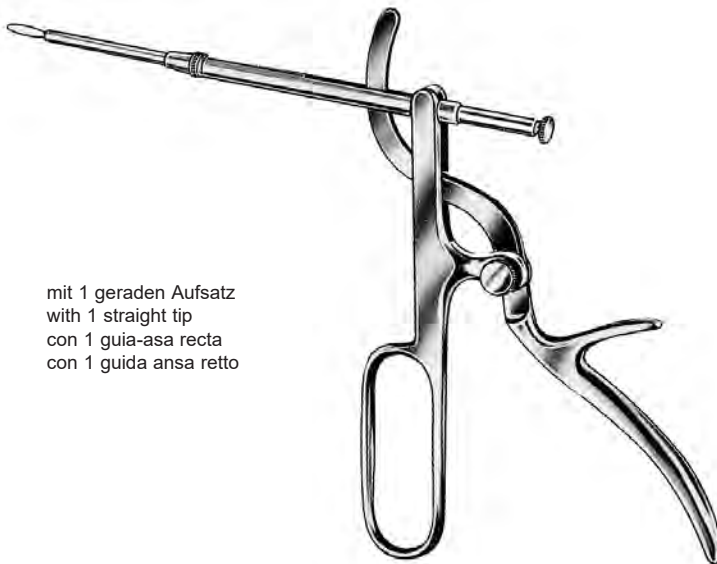


51257-40 40 mm
 51257-50 50 mm
 Pack of 100 pcs



51259-03 0,3 mm
 51259-04 0,4 mm
 51259-05 0,5 mm
 Pack of 12 pcs

Tonsillotom
Tonsillectomes
Amigdalótomos
Tonsillotomi



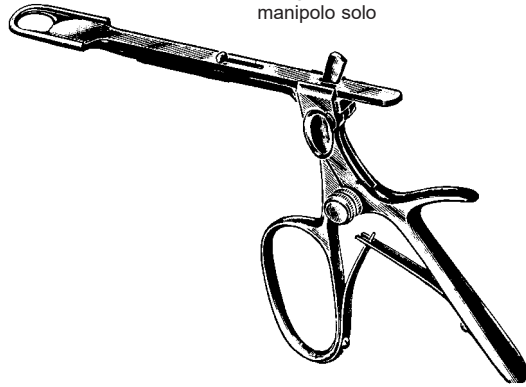
mit 1 geraden Aufsatz
with 1 straight tip
con 1 guida-asa recta
con 1 guida ansa retto

TYDING
51260-00

Tonsillotom, Spritzen, Septum Nadeln
 Tonsillectomes, Syringes, Septum needles
 Amigdalótomos, Jeringas, Septum aguja
 Tonsillotomi, Siringhe, Septum aghi



51291-00
 2,5 mm Ø



51270-04
 Handgriff allein
 Handle only
 mango para
 manipolo solo

SLUDER-BALLENGER
 51270-00
 mit 3 Aufsätzen
 with 3 blades
 con 3 hojas
 con 3 lame



51292-00



51293-45
 45°



51293-90
 90°

Septum-Schere, Kehlkopfpolypenzangen, Deckelhalter
 Septum-Scissors, Laryngeal Polypus Forceps, Epiglottis Retractor
 Tijeras para septo, Pinzas para pólipos laríngeos, Depresor para epiglottis
 Forbice per il setto nasale, Pinze per polipi laringei, Depressore per epiglottide



KILLIAN
 53102-20
 20 cm, 8"



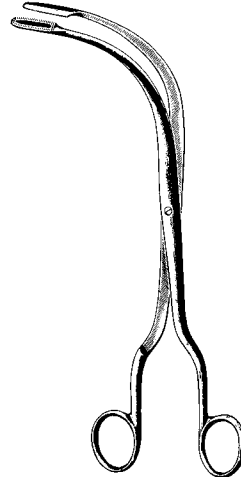
53101-22



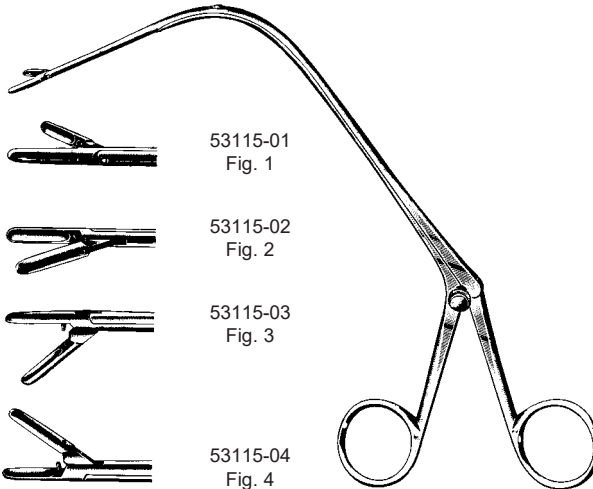
53103-22



JACKSON
 53101-22 - 53103-22
 22 cm, 8 3/4"



FRAENKEL
 53111-18
 18 cm, 7"



53115-01
 Fig. 1

53115-02
 Fig. 2

53115-03
 Fig. 3

53115-04
 Fig. 4

JURASZ
 53115-01 - 53115-04
 23 cm, 9"

Universalgriffe, Verlängerungsrohre, Aufsätze
 Universal Handles, Interchangeable Tips, Tubes
 Mangos universales y Tubos de extension, Puntas
 Manici universali e Tubi di prolungamento, Terminale laringeo



BRUENINGS
 53131-20
 20 cm, 8"



BRUENINGS
 53132-20 20 cm, 8" 53132-50 50 cm, 19 3/4"
 53132-30 30 cm, 11 3/4" 53132-60 60 cm, 23 1/2"
 53132-40 40 cm, 15 3/4"



HUBER
 53130-00



FRAENKEL
 53150-00



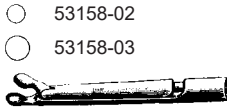
SEIFERT
 53152-00



FRAENKEL
 53154-00



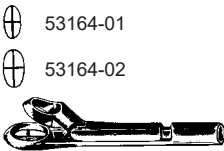
SCHEINMANN
 53157-00



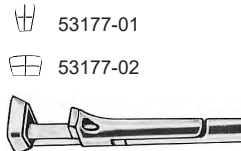
BRUENINGS
 53158-02 - 53158-03



LANGE
 53162-00



53164-01
 53164-02
 KRAUSE
 53164-01 - 53164-02



53177-01
 53177-02
 CORDES
 53177-01 - 53177-02

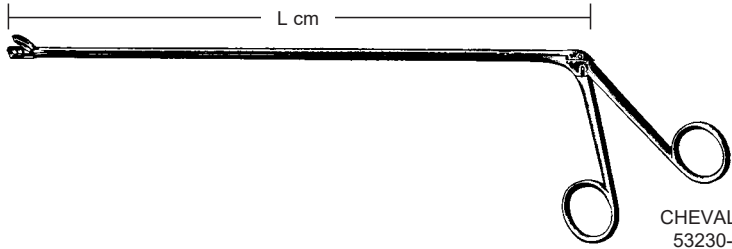


SCHUMACHER
 53170-00



BARACANI
 53175-00

Broncho-Oesophagoskopiezangen, Kehlkopfspiegel, Griffe
 Broncho-Esophagoscopy Forceps, Laryngeal Mirrors, Handles
 Pinzas para bronco-esofagoscopia, Espejos laringeos, Mangos
 Pinze per bronco-esofagoscopia, Specchi laringei, Manici



CHEVALIER-JACKSON
 53230-01 - 53260-08



cm	Fig. 1	Fig. 2	Fig. 3	Fig. 4	Fig. 5	Fig. 6	Fig. 7	Fig. 8
30 / 11 3/4"	53230-01	53230-02	53230-03	53230-04	53230-05	53230-06	53230-07	53230-08
40 / 15 3/4"	53240-01	53240-02	53240-03	53240-04	53240-05	53240-06	53240-07	53240-08
50 / 19 3/4"	53250-01	53250-02	53250-03	53250-04	53250-05	53250-06	53250-07	53250-08
60 / 23 1/2"	53260-01	53260-02	53260-03	53260-04	53260-05	53260-06	53260-07	53260-08

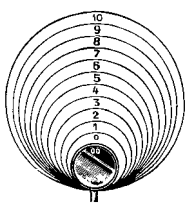


Fig.	mm	Ø
53270-08	00	8
53270-10	0	10
53270-12	1	12
53270-14	2	14
53270-16	3	16
53270-18	4	18
53270-20	5	20
53270-22	6	22
53270-24	7	24
53270-26	8	26
53270-28	9	28
53270-30	10	30



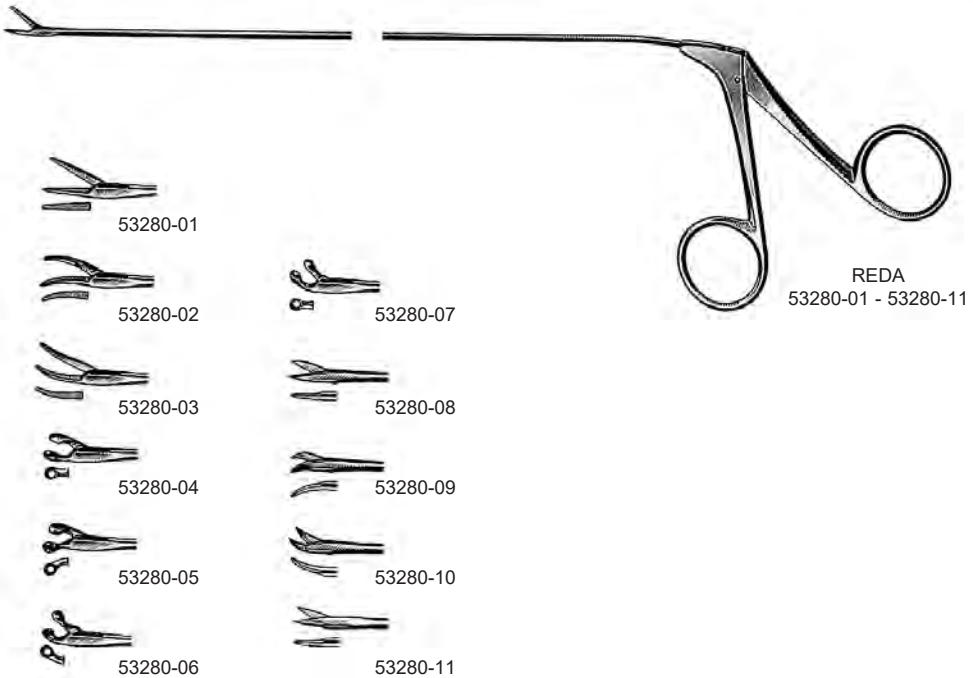
53270-08 - 53270-30
 13,5 cm, 5 1/4"

53272-08 - 53272-30

53274-12

53276-10

Mikro-Rohrschaftzangen
 Micro Laryngeal Forceps
 Pinzas para la micro-cirugía de la laringe
 Pinze ad asta tubolare per microchirurgia



REDA Mikro-Rohrschaftzangen 23 cm (9")

- 53280-01 gerieftes Maul, gerade 1,5 x 10 mm
- 53280-02 gerieftes Maul, links gebogen 1,5 x 8,5 mm
- 53280-03 gerieftes Maul, rechts gebogen 1,5 x 8,5 mm
- 53280-04 Löffelmaul, gerade 2,5 mm
- 53280-05 Löffelmaul, links abgewinkelt 2,5 mm
- 53280-06 Löffelmaul, rechts abgewinkelt 2,5 mm
- 53280-07 Löffelmaul, aufwärts abgewinkelt 2,5 mm
- 53280-08 Schere, gerade, vertikal
- 53280-09 Schere, links gebogen
- 53280-10 Schere, rechts gebogen
- 53280-11 Schere, horizontal schneidend, gerade

REDA Micro-Laryngeal Forceps 23 cm (9")

- 53280-01 Grasping tip, straight, serrated, 1,5 x 10 mm
- 53280-02 Grasping tip, curved to left, serrated, 1,5 x 8,5 mm
- 53280-03 Grasping tip, curved to right, serrated, 1,5 x 8,5 mm
- 53280-04 Cup forceps, straight, 2,5 mm
- 53280-05 Cup forceps, angled to left, 2,5 mm
- 53280-06 Cup forceps, angled to right, 2,5 mm
- 53280-07 Cup forceps, angled up, 2,5 mm
- 53280-08 Scissors, straight, vertical
- 53280-09 Scissors, curved to left
- 53280-10 Scissors, curved to right
- 53280-11 Scissors, straight, horizontal

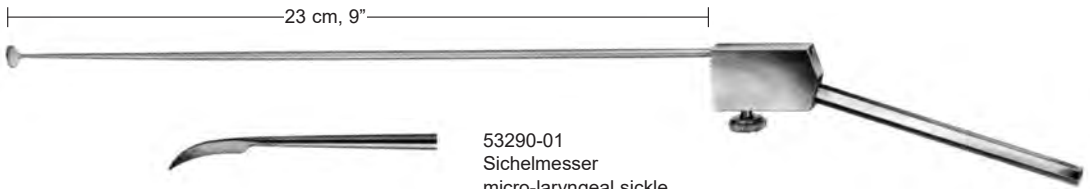
REDA Pinza microlaringea 23 cm (9")

- 53280-01 boca estriada recta 1,5 x 10 mm
- 53280-02 boca estriada curva a la izquierda 1,5 x 8,5 mm
- 53280-03 boca estriada curva a la derecha 1,5 x 8,5 mm
- 53280-04 boca redonda cortante recta 2,5 mm Ø
- 53280-05 boca redonda cortante angulada al la izquierda 2,5 mm Ø
- 53280-06 boca redonda cortante angulada a la derecha 2,5 mm Ø
- 53280-07 boca redonda cortante angulada hacia arriba 2,5 mm Ø
- 53280-08 Tijera recta corte vertical
- 53280-09 Tijera curva a la izquierda
- 53280-10 Tijera curva a la derecha
- 53280-11 Tijera recta corte horizontal

REDA Pinze ad asta tubolare per microchirurgia 23 cm (9")

- 53280-01 morsi zigrinati, retti, 1,5 x 10 mm
- 53280-02 morsi zigrinati, curvi a sinistra, 1,5 x 8,5 mm
- 53280-03 morsi zigrinati, curvi a destra, 1,5 x 8,5 mm
- 53280-04 morsi a forma di cucchiaino rotondo retto, 2,5 mm
- 53280-05 morsi a forma di cucchiaino rotondo angolati a sinistra, 2,5 mm
- 53280-06 morsi a forma di cucchiaino rotondo angolati a destra, 2,5 mm
- 53280-07 morsi a forma di cucchiaino rotondo angolati in alto, 2,5 mm
- 53280-08 forbici, rette, taglio verticale
- 53280-09 forbici, curve a sinistra
- 53280-10 forbici, curve a destra
- 53280-11 forbici, rette, taglio orizzontale

Instrumente für Laryngoskopie
 Instruments for Laryngology
 Instrumentos Laringoscopia
 Strumenti per la Laringoscopia



53290-01
 Sichelmesser
 micro-laryngeal sickle
 microlaringeo cuchillo de hoz
 Coltello falcato



53290-02
 Schälmesser, quer, oval
 micro-laryngeal separator oval, horizontal
 microlaringeo separador ovalado, horizontal
 Separatore ovale verticale



53290-03
 Schälmesser, längs, oval
 micro-laryngeal separator oval, vertical
 microlaringeo separador ovalado, vertical
 Separatore ovale orizzontale



53290-04
 Schälmesser, 45° abgewinkelt
 micro-laryngeal round cutting knife, 45° angled
 microlaringeo cuchillo para cortes redondos, 45° angulado
 Separatore angolato 45°



53290-05
 Häkchen, 90° gebogen stumpf
 micro-laryngeal hook 90° angled, blunt
 microlaringeo ganchito 90° angulado, romo
 Uncino angolato 90° smusso



53290-06
 Häkchen, 30° retrograd gebogen
 micro-laryngeal probe, 30° backwards curved blunt with button
 microlaringeo ganchito, 30° curvo retrogrado
 Uncino angolato retrogrado 30°



53290-07
 Fadengabel
 micro-laryngeal ligature adjuster
 microlaringeo horquilla de hilos
 Forchetta da sutura



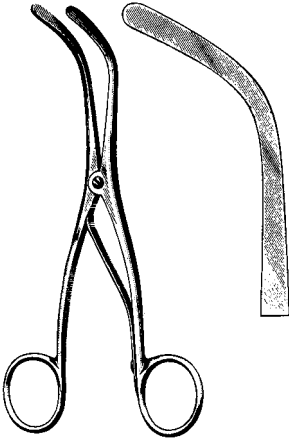
53290-08
 Handgriff für Stabinstrumente
 Handle for microlaryngeal instruments
 Mango para microlaringeos instrumentos
 Manico per strumenti microlaringei

Tracheal Dilatatore, Trachealhaken, Tracheal-Wundspreizer

Trachea Dilators, Trachea hooks, Tracheal Retractors

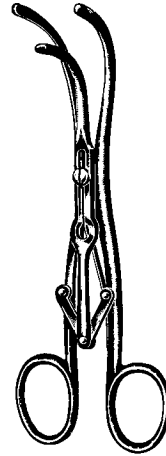
Dilatadores para la tráquea, Ganchos para traqueotomía, Retractor traqueal

Dilatatori per tracheotomia, Ganci per tracheotomia, Divaricatori tracheali



TROUSSEAU-BABY
55111-13 13 cm, 5 1/8"

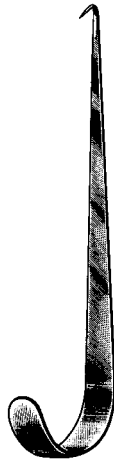
TROUSSEAU
55111-14 14 cm, 5 1/2"



LABORDE
55113-14
14 cm, 5 1/2"



BOSE
55115-07
7 cm, 2 3/4"



JACKSON
55116-15
15 cm, 6"

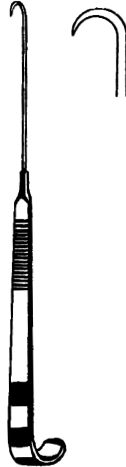


JACKSON
55117-17
17 cm, 6 3/4"

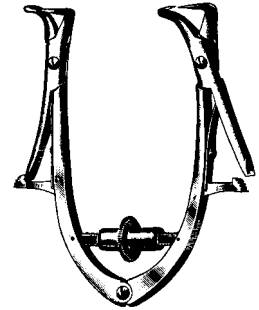
Trachealhaken, Kanüle
 Trachea Hooks, Tubes
 Ganchos para traqueotomía, Cánula
 Ganci per tracheotomia, Cannule



ITERSON
 55118-16 - 55119-16
 16 cm, 6 1/4"



NEWS
 55120-15
 15 cm, 6"

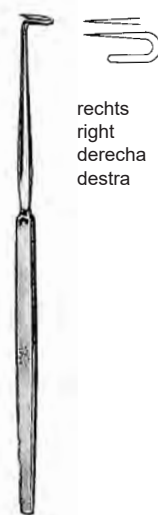


FRIEDMANN
 71351-10 10 cm, 4"
 71351-15 15 cm, 6"



links
 left
 izquierda
 sinistra

BOSE
 55122-16
 16 cm, 6 1/4"

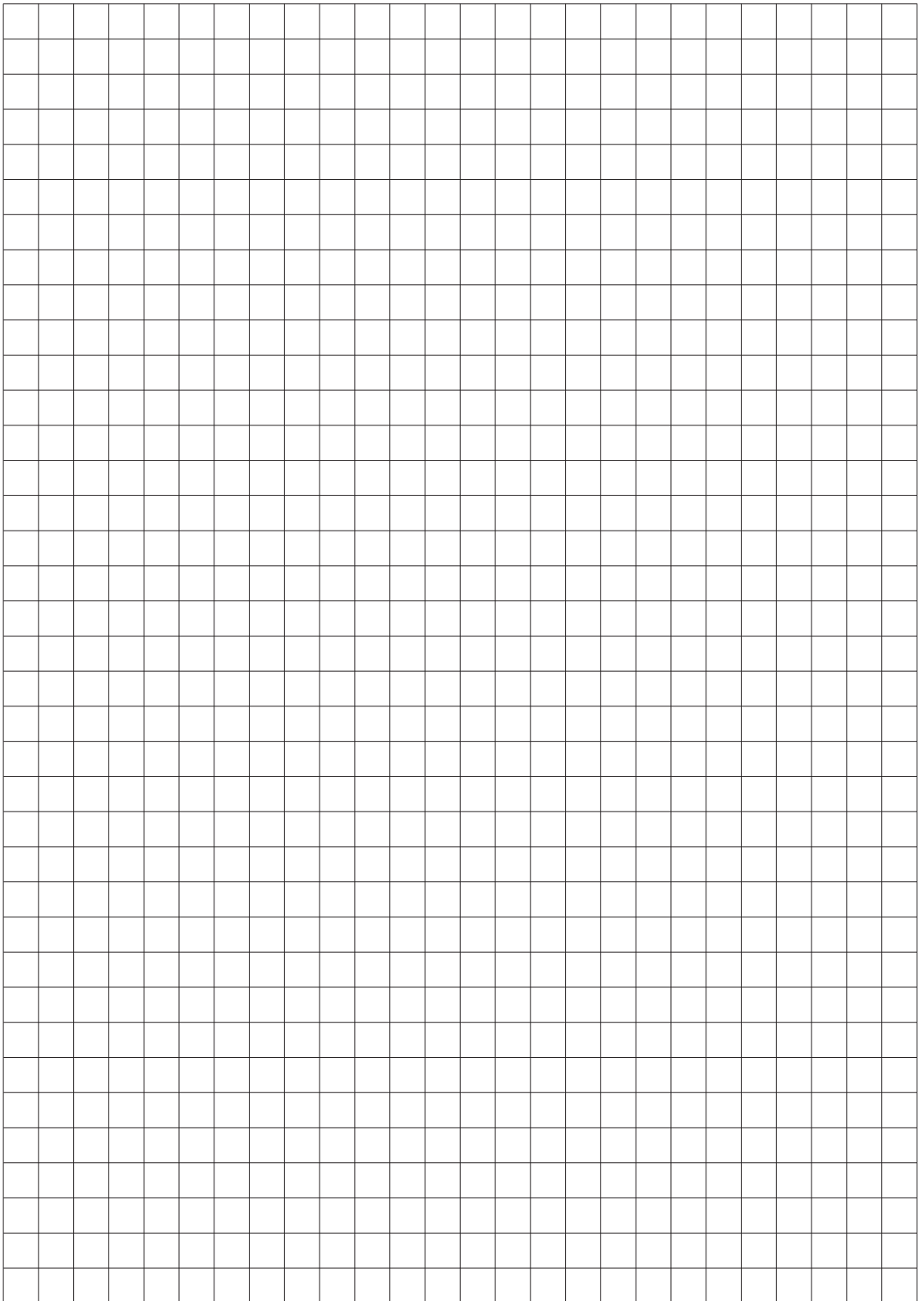


rechts
 right
 derecha
 destra

BOSE
 55124-16
 16 cm, 6 1/4"



WAGENER-MOSHER
 55151-05 5 mm
 55151-07 7 mm
 55151-09 9 mm



Tracheal-Kanülen, Schilddrüsenhaken, Sonde, Kropffaßzange, Muskelklemme
 Tracheal Tubes, Thyroid Gland Retractor, Directors-Enucleators, Goitre Seizing Forceps, Muscular Clamp
 Cánulas traqueales, Separador para la glándula tiroidea, Sondas,
 Pinza para coger el bocio, Pinza-clamp para músculos
 Cannule tracheali, Divaricatori per la tiroide, Sonde, Pinze per gozzo, Pinza muscolare



LUER

Neusilber
 German silver
 alpaca
 argentone



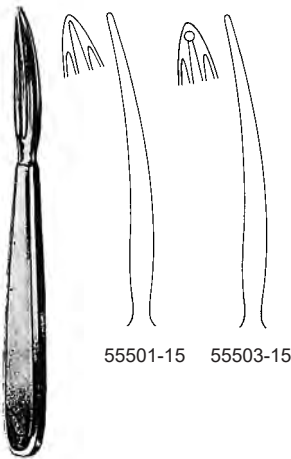
CHEVALIER-JACKSON

Neusilber
 German silver
 alpaca
 argentone

Fig.	Ø mm	Länge des Außenrohrs Length of outer tube Largo de la cánula exterior Lunghezza del tubo esterno
0	4	45 mm
1	5	50 mm
2	6	55 mm
3	7	60 mm
4	8	65 mm
5	9	70 mm
6	10	75 mm
7	11	80 mm
8	12	85 mm
9	13	90 mm

55220-04
 55220-05
 55220-06
 55220-07
 55220-08
 55220-09
 55220-10
 55220-11
 55220-12
 55220-13

55240-04
 55240-05
 55240-06
 55240-07
 55240-08
 55240-09
 55240-10
 55240-11
 55240-12
 55240-13

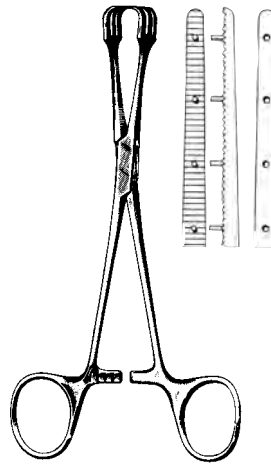


55501-15 55503-15

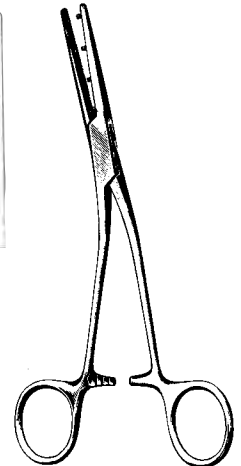
KOCHER
 55501-15 - 55503-15
 15 cm, 6"



SCHOENBORN
 55511-21
 21 cm, 8 1/4"



LAHEY
 55520-15 15 cm, 6"
 55520-20 20 cm, 8"



MASTIN
 55523-17
 17 cm, 6 3/4"

Rippenscheren
Rib Shears
Costótomos
Costotomi



COLLIN
57102-23
23 cm, 9"



57105-22
22 cm, 8 3/4"



GLUCK
57107-22
22 cm, 8 3/4"

mit ziehendem Schnitt
with eccentric sliding blade
con hoja de retroacción
con lama di retroazione



STILLE
57111-21
21 cm, 8 1/4"



CORYLLOS
57123-35
35 cm, 13 3/4"

CORYLLOS
57125-35
35 cm, 13 3/4"

Rippenscheren, Sternumscheren
 Rib Shears, Sternum Scissors
 Costótomos, Tijeras de esternón
 Costotomi, Forbici per sterno



BETHUNE
 57126-34
 34 cm, 13 1/2"



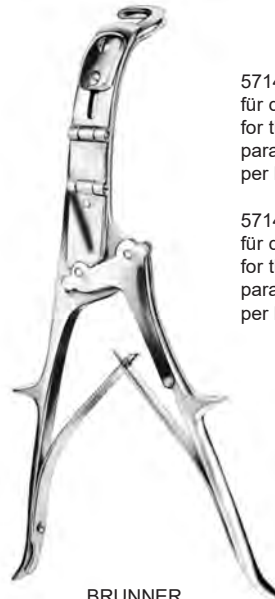
SAUERBRUCH
 57131-26
 26 cm, 10 1/4"



GIERTZ-STILLE
 57137-27
 27 cm, 10 1/2"



SCHUMACHER
 57138-21
 21 cm, 8 1/4"



BRUNNER
 57146-28 - 57147-28
 28 cm, 11"

57146-28
 für die rechte Hand
 for the right hand
 para la mano derecha
 per la mano destra

57147-28
 für die linke Hand
 for the left hand
 para la mano izquierda
 per la mano sinistra

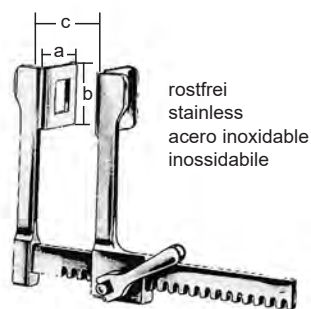
Rippensperrer
Rib Spreaders
Separadores costales
Divaricatori costali



rostfrei
stainless
acero inoxidable
inossidabile

FINOCHIETTO

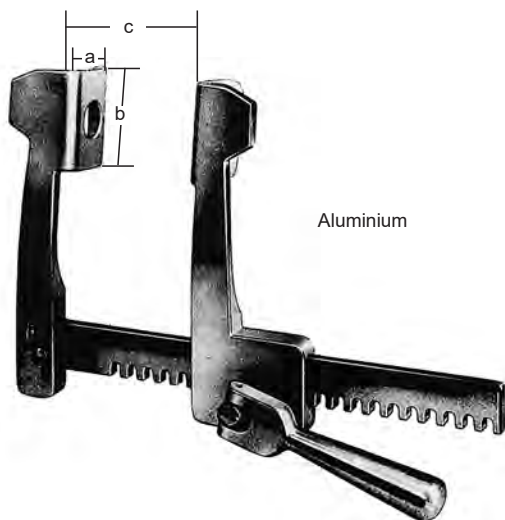
	a	b	c
	mm	mm	mm
57210-16	38	44	160
57210-20	52	62	200
57210-25	65	85	250



rostfrei
stainless
acero inoxidable
inossidabile

FINOCHIETTO-BABY

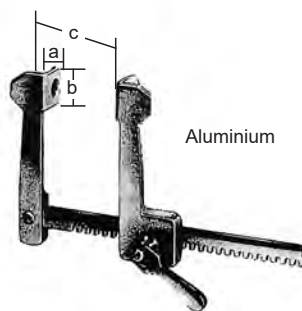
	a	b	c
	mm	mm	mm
57214-75	18	20	75



Aluminium

FINOCHIETTO

	a	b	c
	mm	mm	mm
57230-13	38	44	135
57230-18	85	65	175



Aluminium

FINOCHIETTO-BABY

	a	b	c
	mm	mm	mm
57234-75	15	15	75

Rippensperrer
Rib Spreaders
Separadores costales
Divaricatori costali

FINOCHIETTO-BURFORD

	a	b	c
	mm	mm	mm
57236-20	65	62	200
	47	62	
57236-25	65	62	250
	47	62	
57236-30	65	62	300
	47	52	



rostfrei
stainless
acero inoxidable
inoxidabile

Erwachsene
Adult Size
para adultos
per adulti

FINOCHIETTO-BURFORD

	a	b	c
	mm	mm	mm
57242-20	65	62	200
	47	62	
57242-25	65	62	250
	47	62	
57242-30	65	62	300
	47	52	



Aluminium

Kinder
Child Size
para niños
per bambini

FINOCHIETTO-BURFORD

	a	b	c
	mm	mm	mm
57244-13	34	42	135
	48	42	

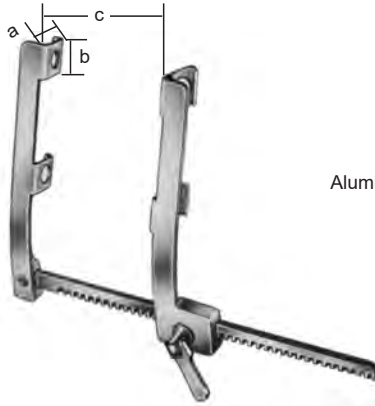


Aluminium

Rippensperrer
Rib Spreaders
Separadores costales
Divaricatori costali

FINOCHIETTO

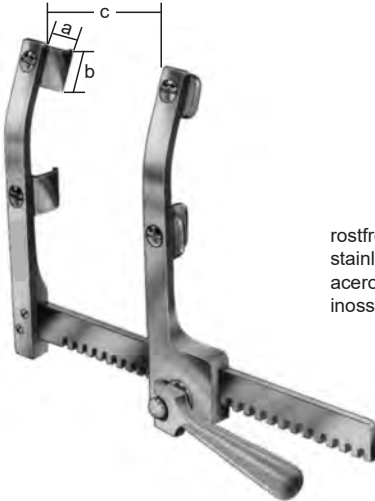
	a	b	c
	mm	mm	mm
57245-13	14	14	120



Aluminium

MORSE

	a	b	c
	mm	mm	mm
57246-16	17	22	160

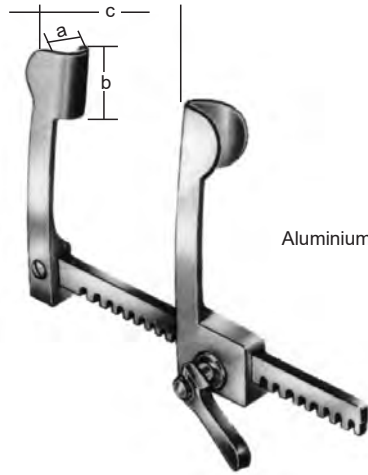
rostfrei
stainless
acero inoxidable
inossidabile

MORSE-FAVALORO

	a	b	c
	mm	mm	mm
57246-21	19	27	210

rostfrei
stainless
acero inoxidable
inossidabile

Rippensperrer
 Rib Spreaders
 Separadores costales
 Divaricatori costali

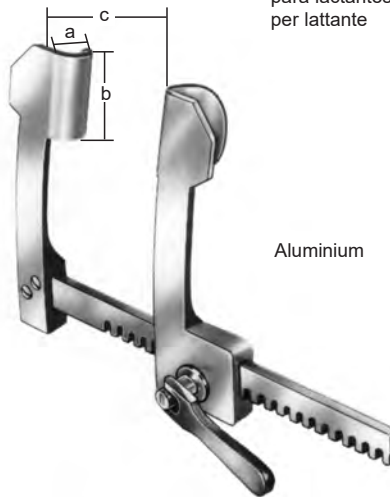


Aluminium

COOLEY-NEONATAL

	a	b	c
	mm	mm	mm
57247-95	12	16	95

Kleinstkinder
 Pediatric size
 para lactantes
 per lattante

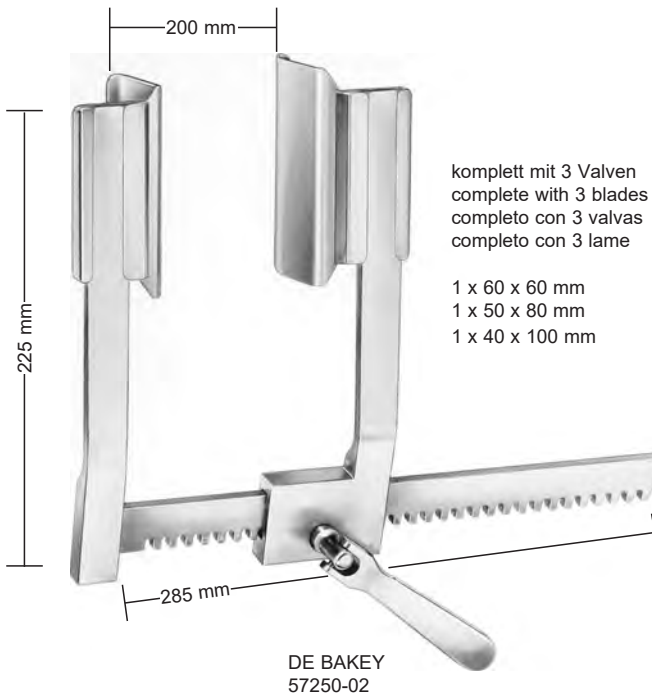
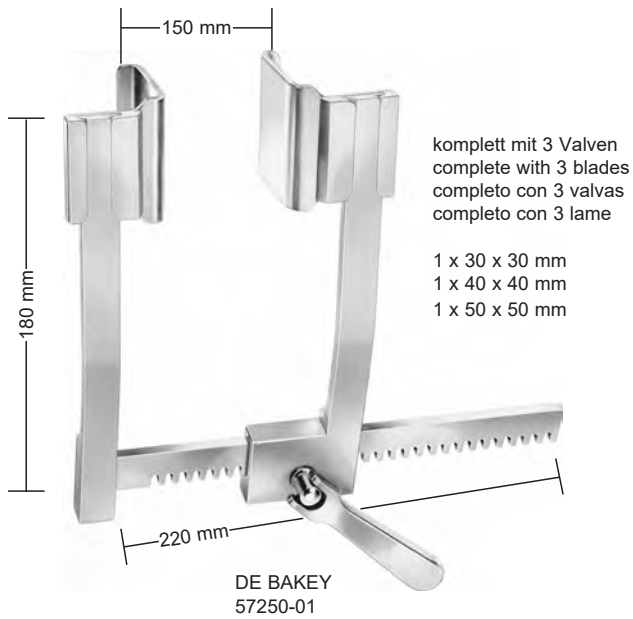


Aluminium

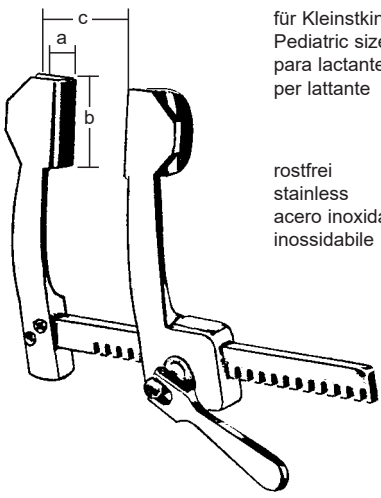
COOLEY

	a	b	c
	mm	mm	mm
57248-14	15	30	140

Rippensperrer
 Rib Spreaders
 Separadores costales
 Divaricatori costali



Rippensperrer
Rib Spreaders
Separadores costales
Divaricatori costali

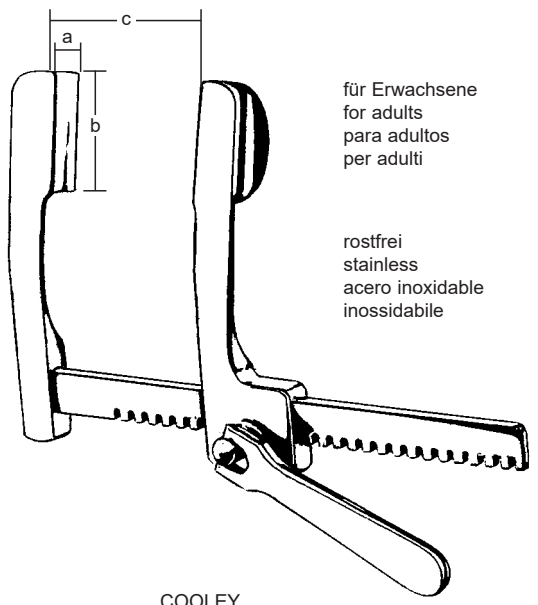


für Kleinstkinder
Pediatric size
para lactantes
per lattante

rostfrei
stainless
acero inoxidable
inossidabile

COOLEY

	a	b	c
	mm	mm	mm
57260-02	16	30	105
57260-03	21	44	150



für Erwachsene
for adults
para adultos
per adulti

rostfrei
stainless
acero inoxidable
inossidabile

COOLEY

	a	b	c
	mm	mm	mm
57260-04	37	49	200



rostfrei
stainless
acero inoxidable
inossidabile

HAIGHT

	a	b	c	h
	mm	mm	mm	mm
57260-09	30	30	90	90

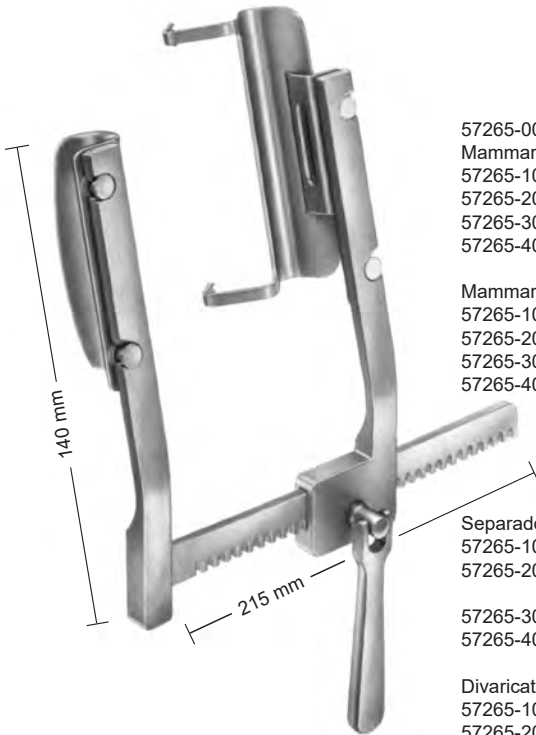


rostfrei
stainless
acero inoxidable
inossidabile

TUFFIER

	a	b	c
	mm	mm	mm
57264-16	50	45	165

Sternum-Sperrer
Sternum Retractors
Separador de esternón
Divaricatore sternale



57265-00

Mammaria Sperrer, komplett bestehend aus:

57265-10 Sperrer allein

57265-20 Mammariablatt, komplett mit Aufnahmeblatt links und rechts

57265-30 1 Paar Sternumblätter 30x100 mm

57265-40 1 Paar Sternumblätter 40x100 mm

Mammaria spreader, complete consisting of:

57265-10 Retractor only

57265-20 Mammaria blade complete with holding blades left and right

57265-30 1 pair of sternum blades 30x100 mm

57265-40 1 pair of sternum blades 40x100 mm

Separador de mamaria, completo compuesto por:

57265-10 Sólo retractor

57265-20 Hoja de mamaria completa

con hojas de sujeción a la izquierda y a la derecha

57265-30 1 par de hojas de esternón 30x100 mm

57265-40 1 par de hojas de esternón 40x100 mm

Divaricatore per mammarie, completo di:

57265-10 Solo divaricatore

57265-20 Lama per mammaria completa

di lame di contenimento destra e sinistra

57265-30 1 coppia di lame per sterno 30x100 mm

57265-40 1 coppia di lame per sterno 40x100 mm



57265-20

Mammariablatt, komplett

Mammaria blade, complete

Hoja de mamaria, completa

Lama di mammaria, completa



57265-30

Sternumblätter 30x100 mm

Sternum blades 30x100 mm

Hojas de esternón 30x100 mm

Lame per sterno 30x100 mm

57265-40

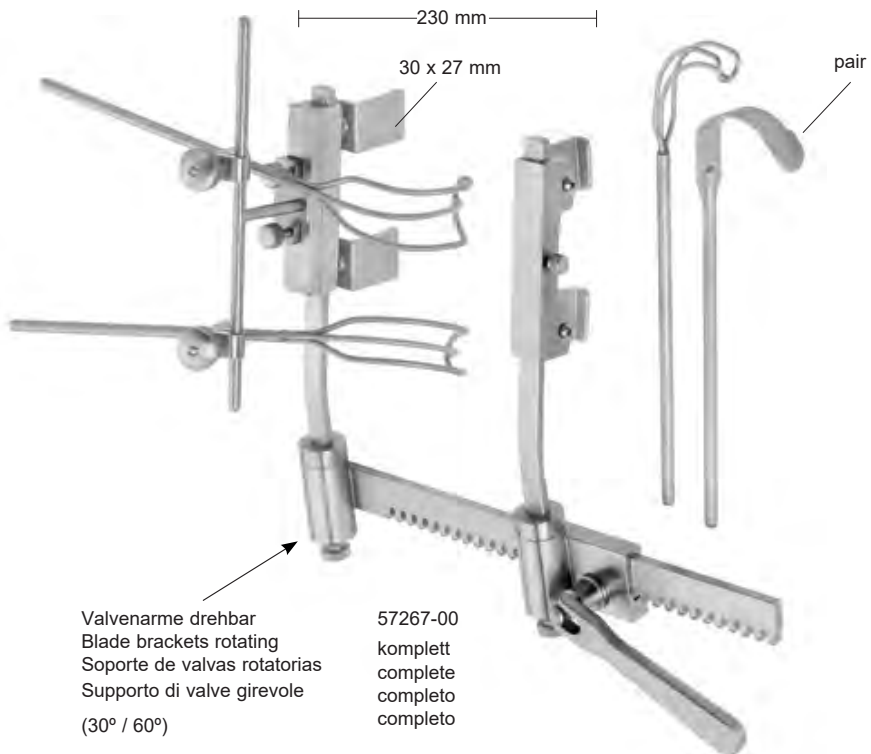
Sternumblätter 40x100 mm

Sternum blades 40x100 mm

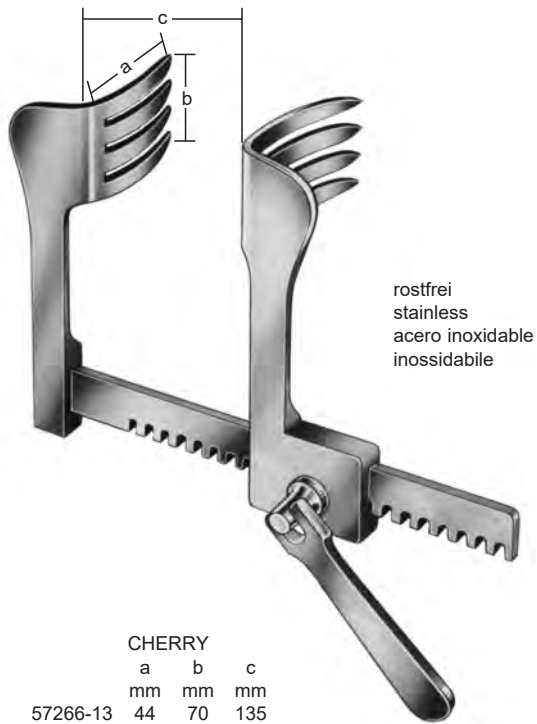
Hojas de esternón 40x100 mm

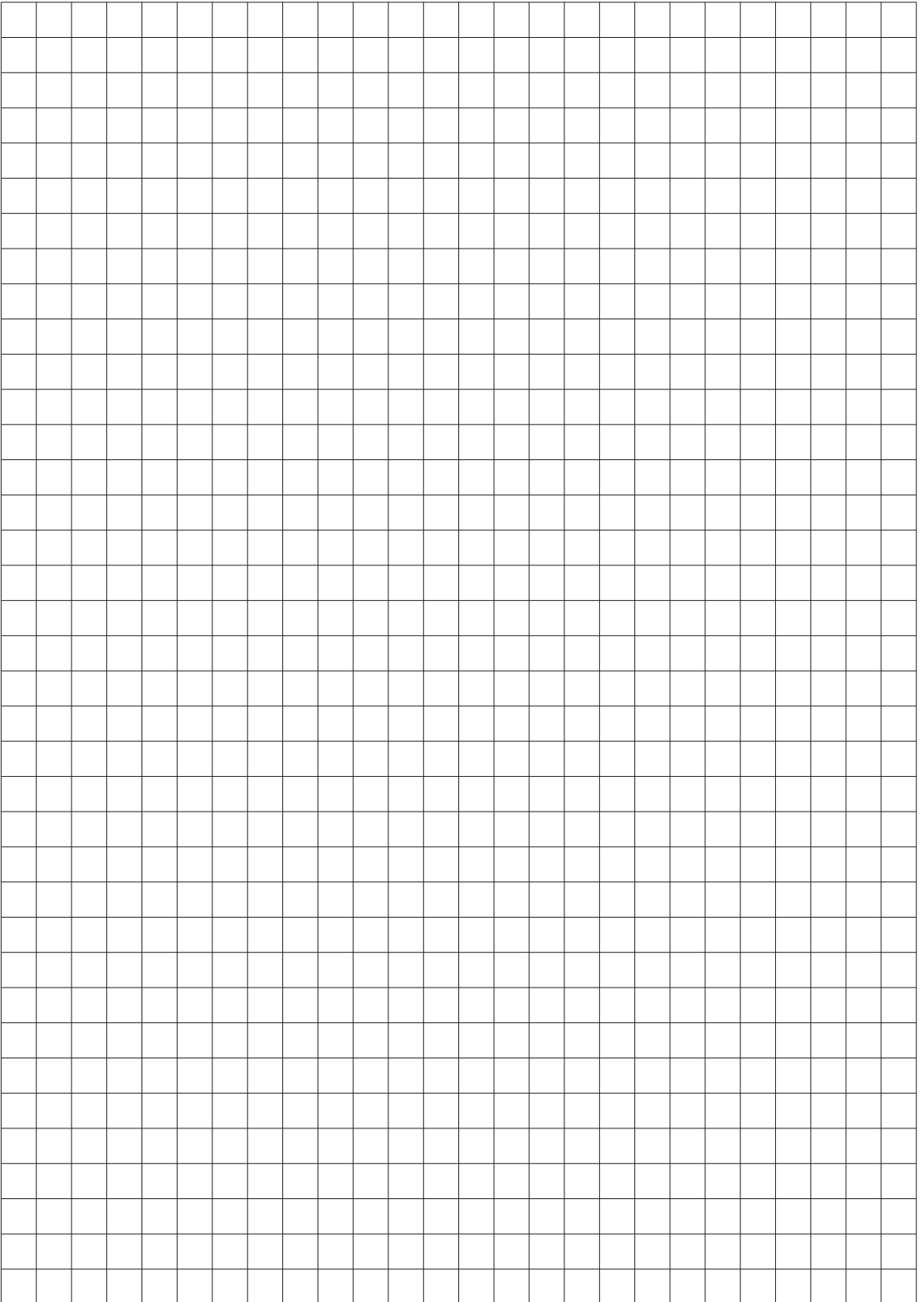
Lame per sterno 40x100 mm

Rippensperrer
Rib Spreaders
Separadores costales
Divaricatori costali



Laminektomie-Sperrer
 Laminectomy-Retractor
 Separadores para laminectomía
 Divaricatori Laminectomia





Rippenkontraktoren
 Rib Contractors
 Aproximadores para costillas
 Approssimatori costali



SELLORS
 57280-19
 20 cm, 8"



BAILEY-BABY
 57283-14
 14 cm, 5 1/2"



BAILEY
 57284-16
 16 cm, 6 1/4"

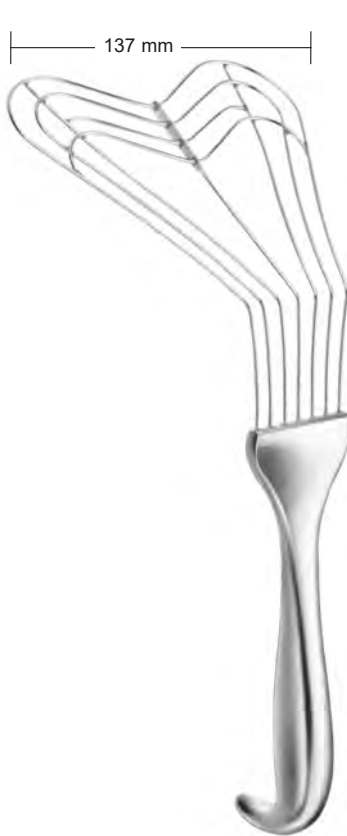
kurze Klauen
 short claws
 garras cortas
 pinze corte



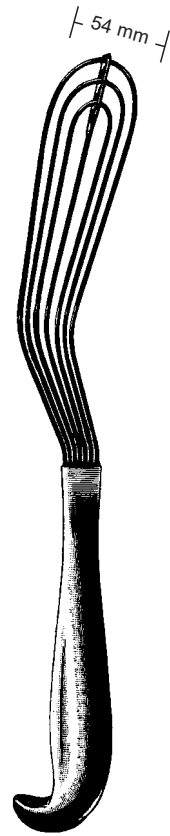
BAILEY-GIBBON
 57286-16
 16 cm, 6 1/4"

lange Klauen
 long claws
 garras largas
 pinze lunghe

Lungenspatel
Lung Spatulas
Espátulas pulmonares
Spatole per polmone

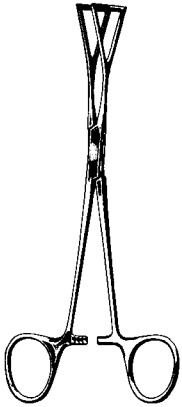


57288-30
30 cm, 11 ³/₄"

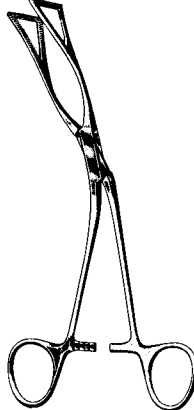
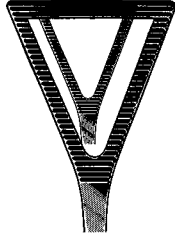


ALLISON
57289-32
32 cm, 12 ³/₄"

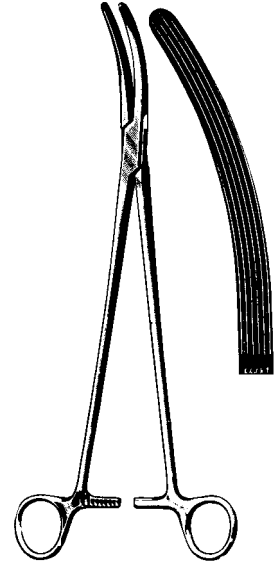
Lungenfaßzange, Bronchusklemmen
 Lung Grasping Forceps, Bronchus Forceps
 Pinzas para coger el pulmón, Pinzas clamps bronquiales
 Pinze per afferrare il polmone, Pinze per bronchi



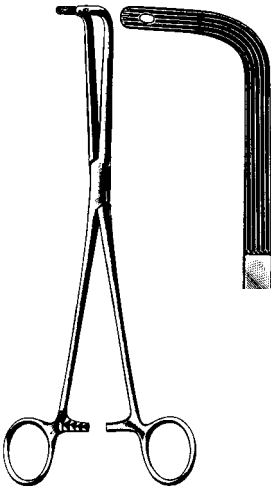
LOVELACE
 57290-20
 20 cm, 8"



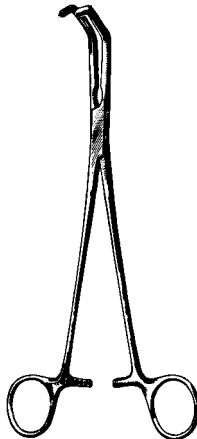
LOVELACE
 57291-20
 20 cm, 8"



HARRINGTON
 57301-30
 30,5 cm, 12"

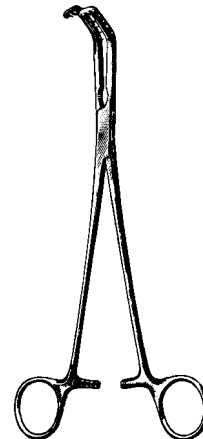


FINOCIETTO
 57307-24
 24 cm, 9 1/2"



PRICE-THOMAS
 57309-22
 22 cm, 8 3/4"

57311-22
 Zähne links
 tooth left
 dientes izquierda
 denti sinistro



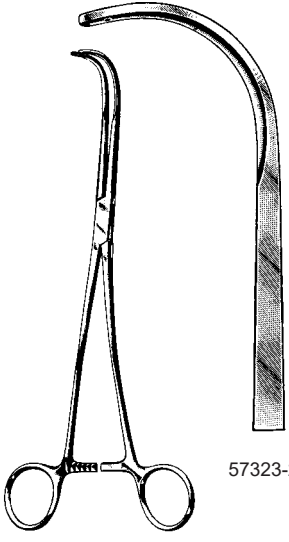
PRICE-THOMAS
 22 cm, 8 3/4"

57313-22
 Zähne rechts
 tooth right
 dientes derecha
 denti destro

Bronchusklemmen, Gefäßklemmen
Bronchus Forceps, Blood Vessel Clamps
Pinzas clamps bronquiales, Pinzas-clamps para vasos
Pinze per bronchi, Pinze cardiovascolari

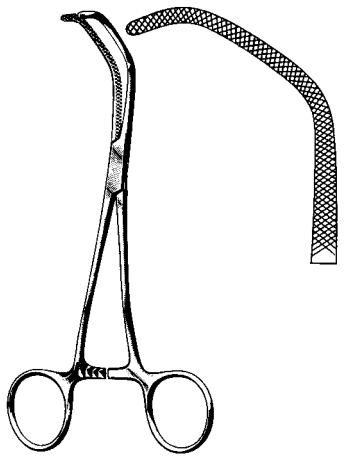


57321-23

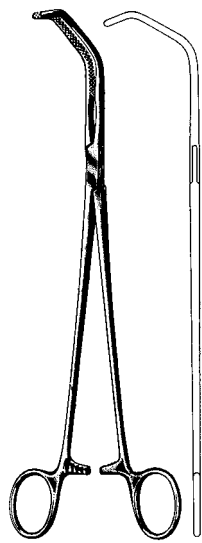


SEMB
23 cm, 9"

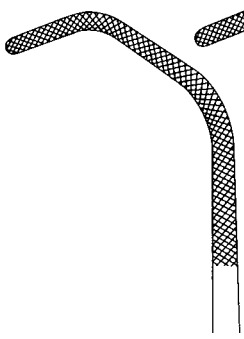
57323-23



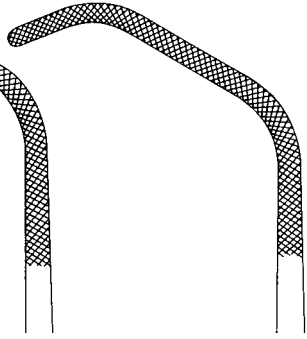
SATINSKY
57325-15
15 cm, 6"



SATINSKY
57327-26 - 57329-26
26 cm, 10 1/4"

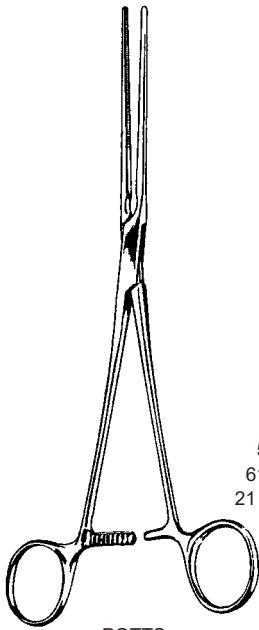


57327-26
Fig. 1

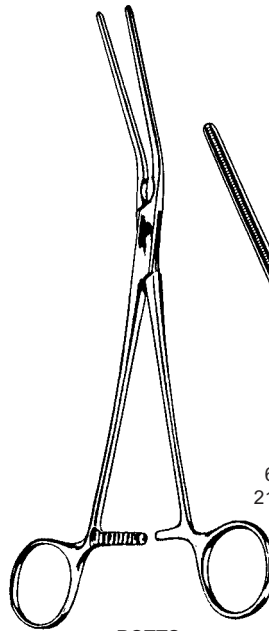
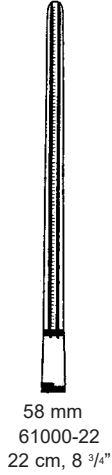
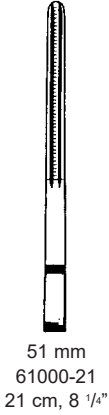


57329-26
Fig. 2

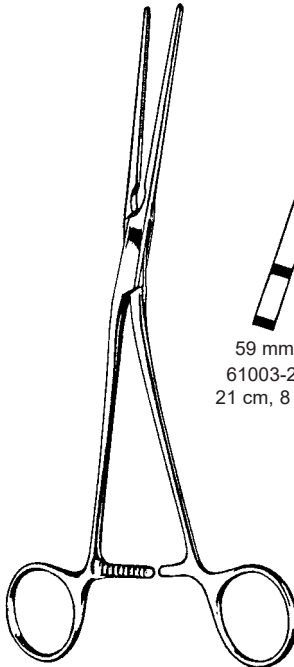
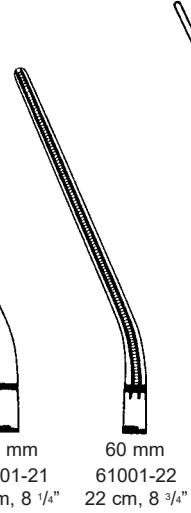
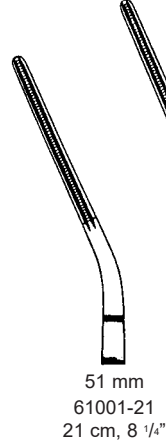
Coarctations-Klemmen
 Coarctation clamps
 Pinzas clamps para coartación
 Pinza per coartazione



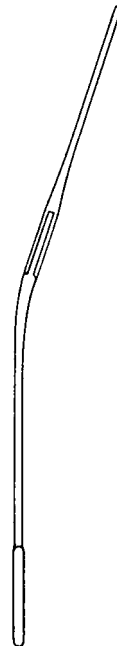
POTTS
 61000-21 - 61000-22



POTTS
 61001-21 - 61001-22

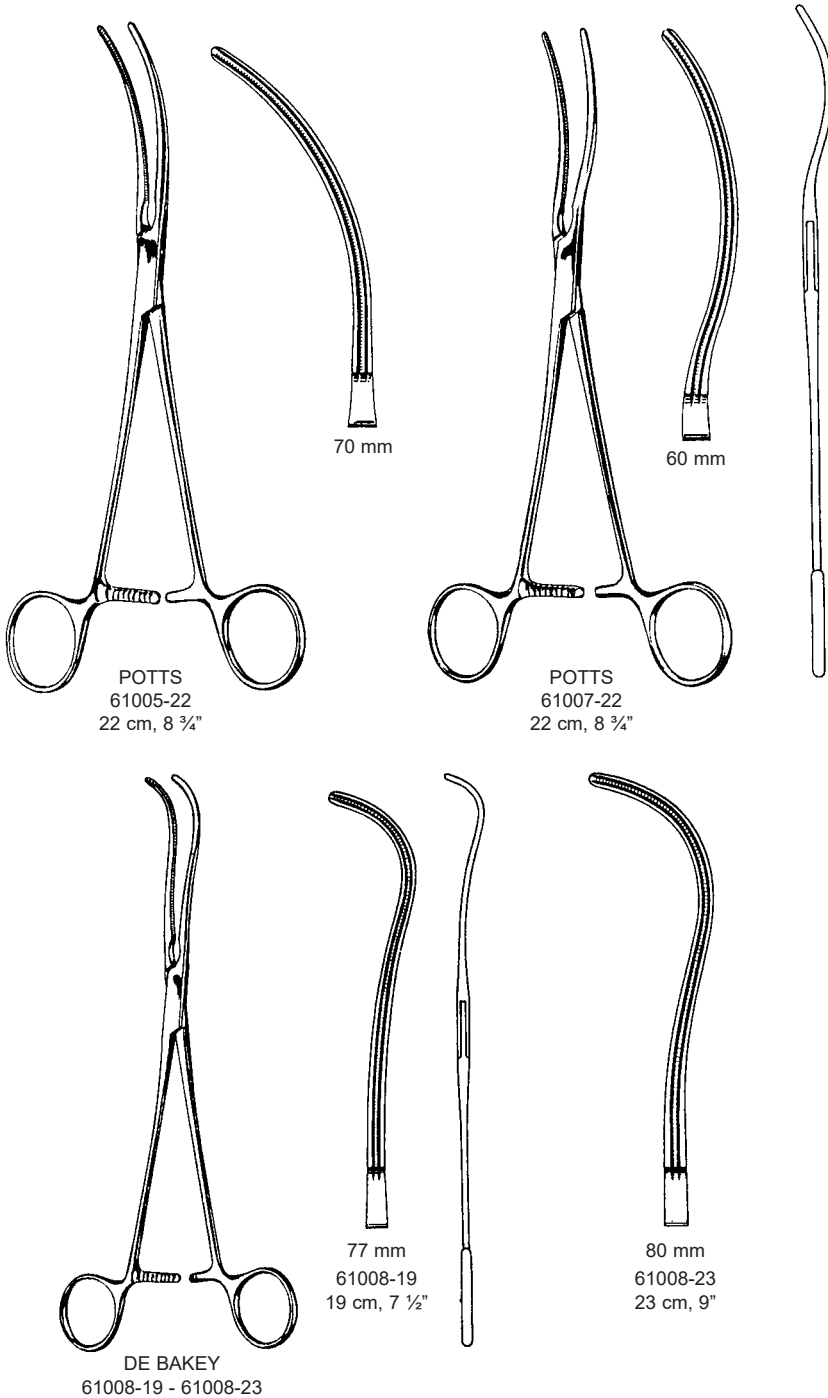


POTTS
 61003-21 - 61003-22

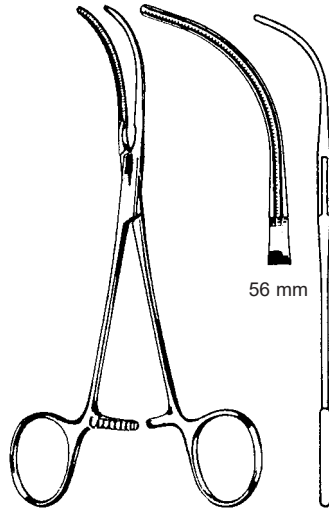


Atrauma

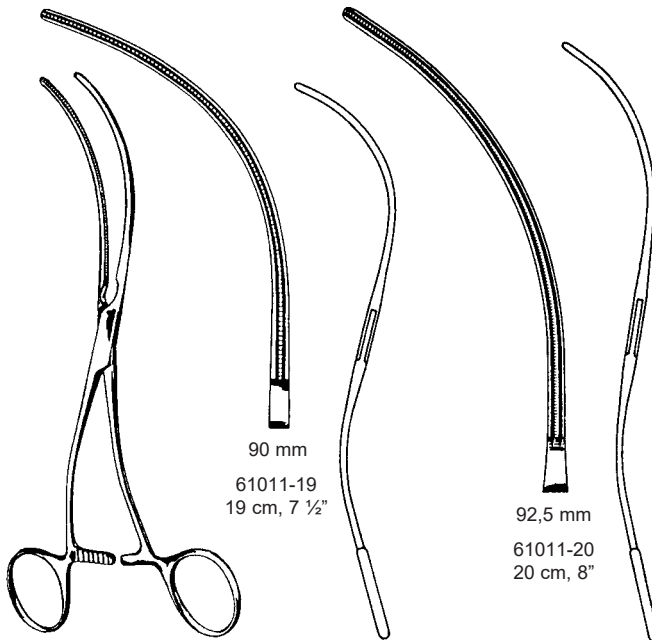
Anastomosens-Klemmen, Präparier- und Ligaturklemmen
 Anastomosis clamps, Dissecting and ligature forceps
 Pinzas clamps para anastomosis, Pinzas para preparaciones y ligaduras
 Pinze per anastomosi, Pinze per preparazioni e legature



Peripheral-Gefäßklemmen
 Peripheral vascular clamps
 Pinzas-clamps para vasos periféricos
 Pinze vascolari periferici



DE BAKEY
 61009-16
 16 cm, 6 1/4"



90 mm
 61011-19
 19 cm, 7 1/2"

92,5 mm
 61011-20
 20 cm, 8"

DE BAKEY
 61011-19 - 61011-20

Atrauma

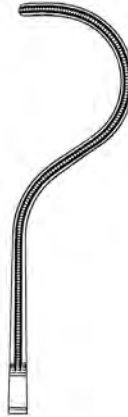
Peripheral-Gefäßklemmen
 Peripheral vascular clamps
 Pinzas-clamps para vasos periféricos
 Pinze vascolari periferici



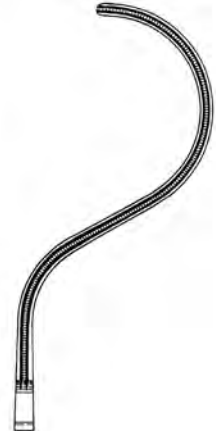
DALE



61012-17
17,5 cm, 7"



61012-18
18 cm, 7"



61012-19
18,5 cm, 7 1/4"



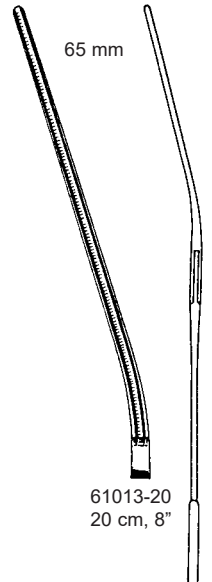
LELAND-JONES
61013-18 - 61013-20



61013-18
18 cm, 7"

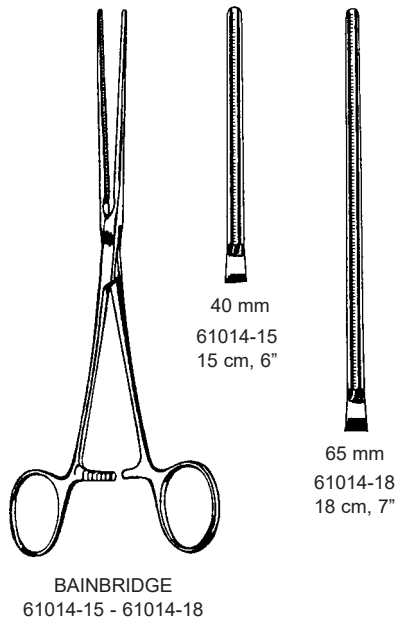


61013-19
19 cm, 7 1/2"



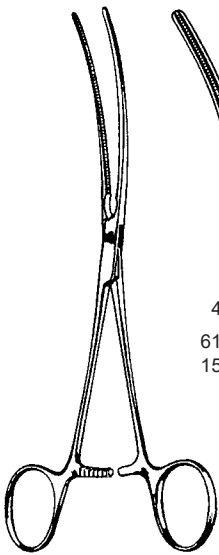
61013-20
20 cm, 8"

Peripheral-Gefäßklemmen
Peripheral vascular clamps
Pinzas-clamps para vasos periféricos
Pinze vascolari periferici



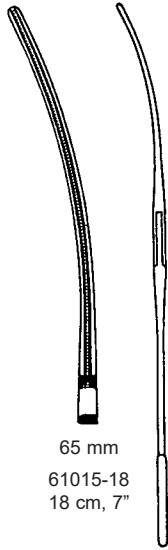
Atrauma

Peripheral-Gefäßklemmen
 Peripheral vascular clamps
 Pinzas-clamps para vasos periféricos
 Pinze vascolari periferici

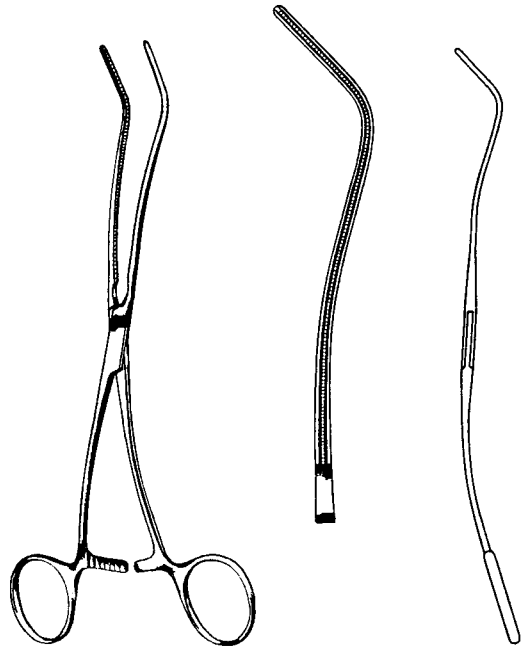


BAINBRIDGE
 61015-15 - 61015-18

40 mm
 61015-15
 15 cm, 6"

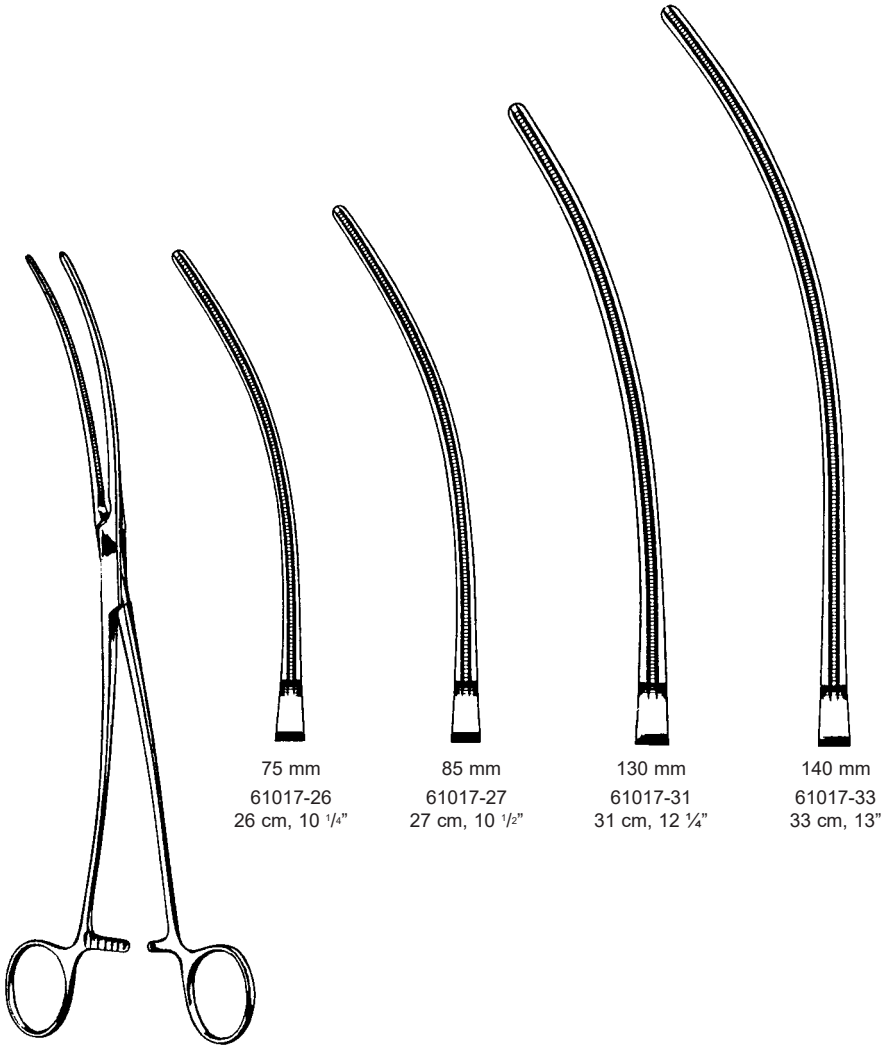


65 mm
 61015-18
 18 cm, 7"



DE BAKEY
 61016-20
 20 cm, 8"

Aorta-Aneurysmaklemmen
 Aortic aneurysm clamps
 Pinzas-clamps para aneurisma de la aorta
 Pinze per aneurisma aorta



75 mm
 61017-26
 26 cm, 10 1/4"

85 mm
 61017-27
 27 cm, 10 1/2"

130 mm
 61017-31
 31 cm, 12 1/4"

140 mm
 61017-33
 33 cm, 13"

DE BAKEY
 61017-26 - 61017-33

Atrauma

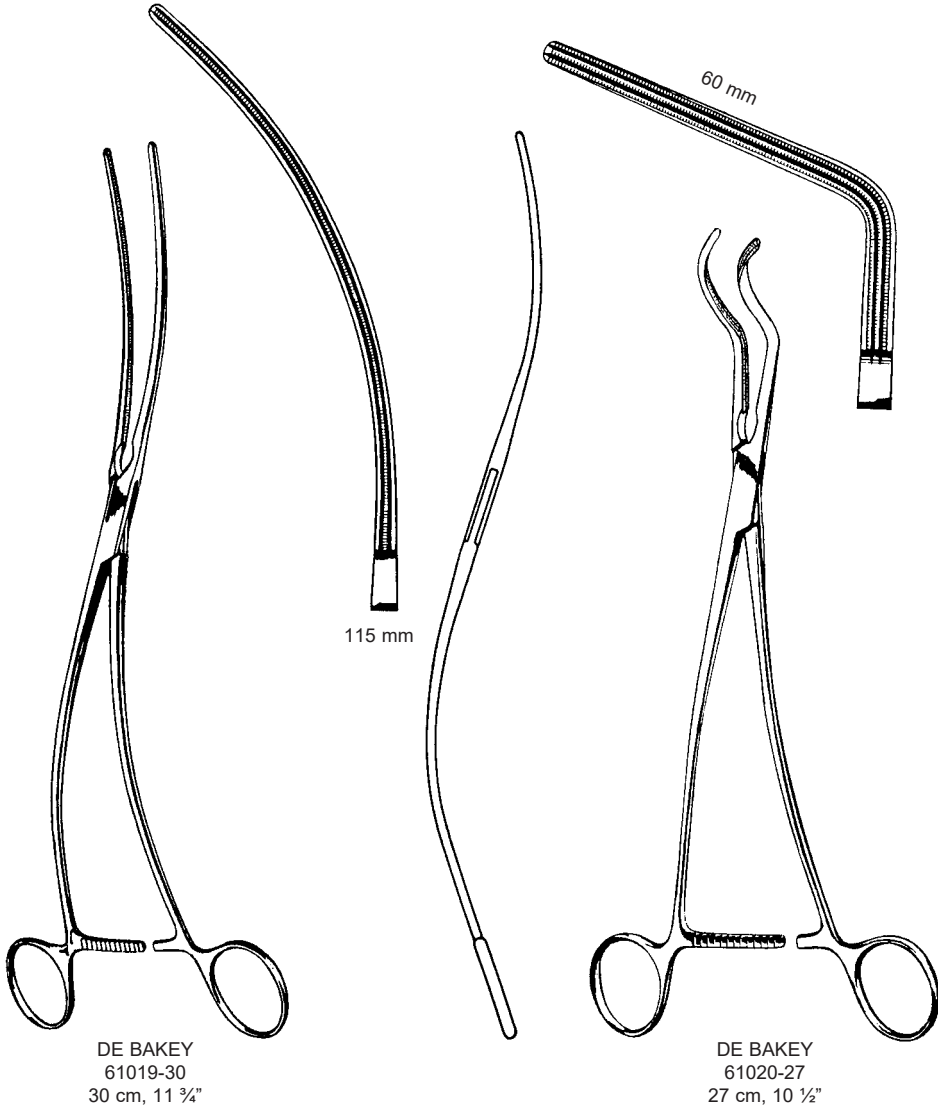
Aorta-Aneurysmaklemmen
Aortic aneurysm clamps
Pinzas-clamps para aneurisma de la aorta
Pinze per aneurisma aorta



86 mm

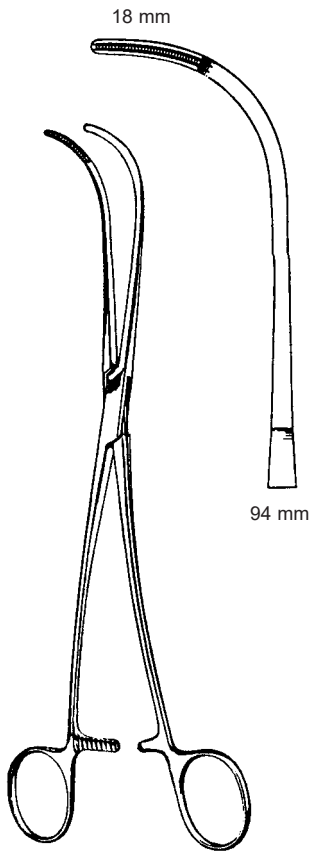
DE BAKEY
61018-28
28 cm, 11"

Aorta-Aneurysmaklemmen
 Aortic aneurysm clamps
 Pinzas-clamps para aneurisma de la aorta
 Pinze per aneurisma aorta

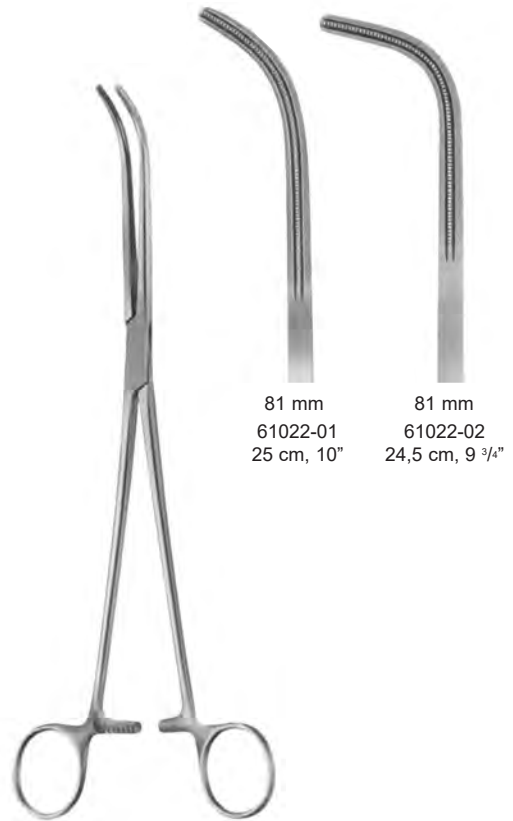


Atrauma

Präparier- und Ligaturklemme
 Dissecting- and Ligature clamp
 Pinzas clamps para disección, ligaduras
 Pinze per dissezione, legature



DE BAKEY
 61021-24
 24 cm, 9 1/2"

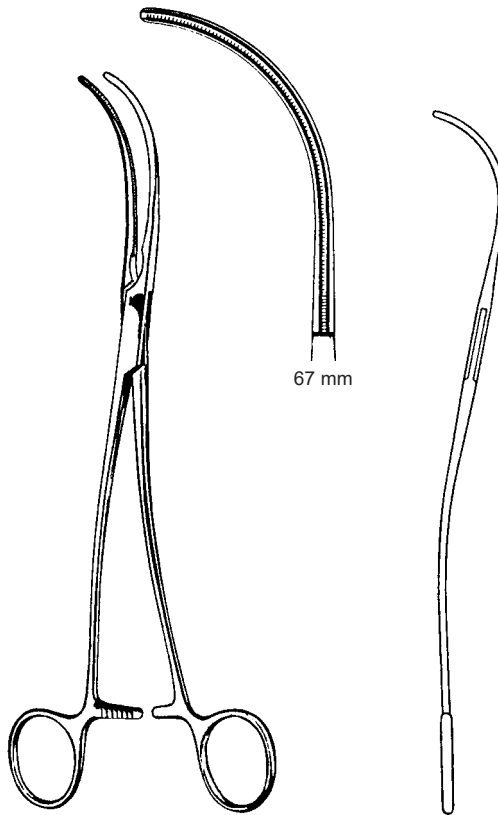


81 mm
 61022-01
 25 cm, 10"

81 mm
 61022-02
 24,5 cm, 9 3/4"

DE BAKEY-RUMEL

Ligaturklemmen
Ligature clamps
Pinzas clamps para ligaduras
Pinze per legature



67 mm

DE BAKEY
61022-24
24 cm, 9 1/2"

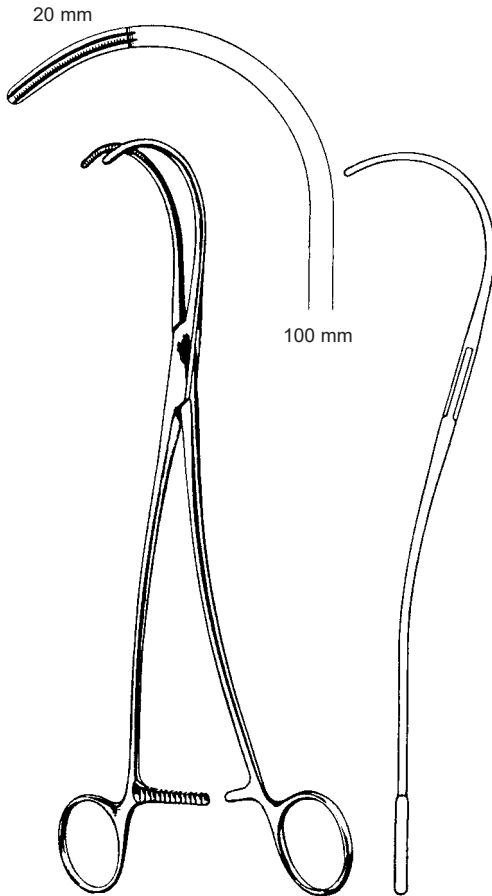
Atrauma

Präparier- und Ligaturklemmen
Dissecting- and Ligature clamps
Pinza para disección y ligatura
Pinze per dissezione e legature

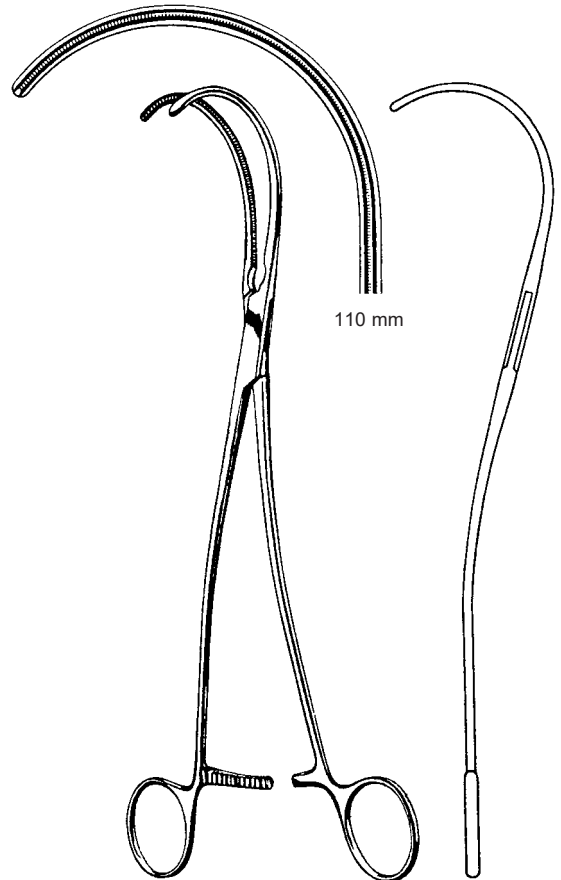


DE BAKEY-MIXTER
61022-28
28,5 cm, 11 1/4"

Ligaturklemme
Ligature clamp
Pinzas clamps para ligaduras
Pinze per legature



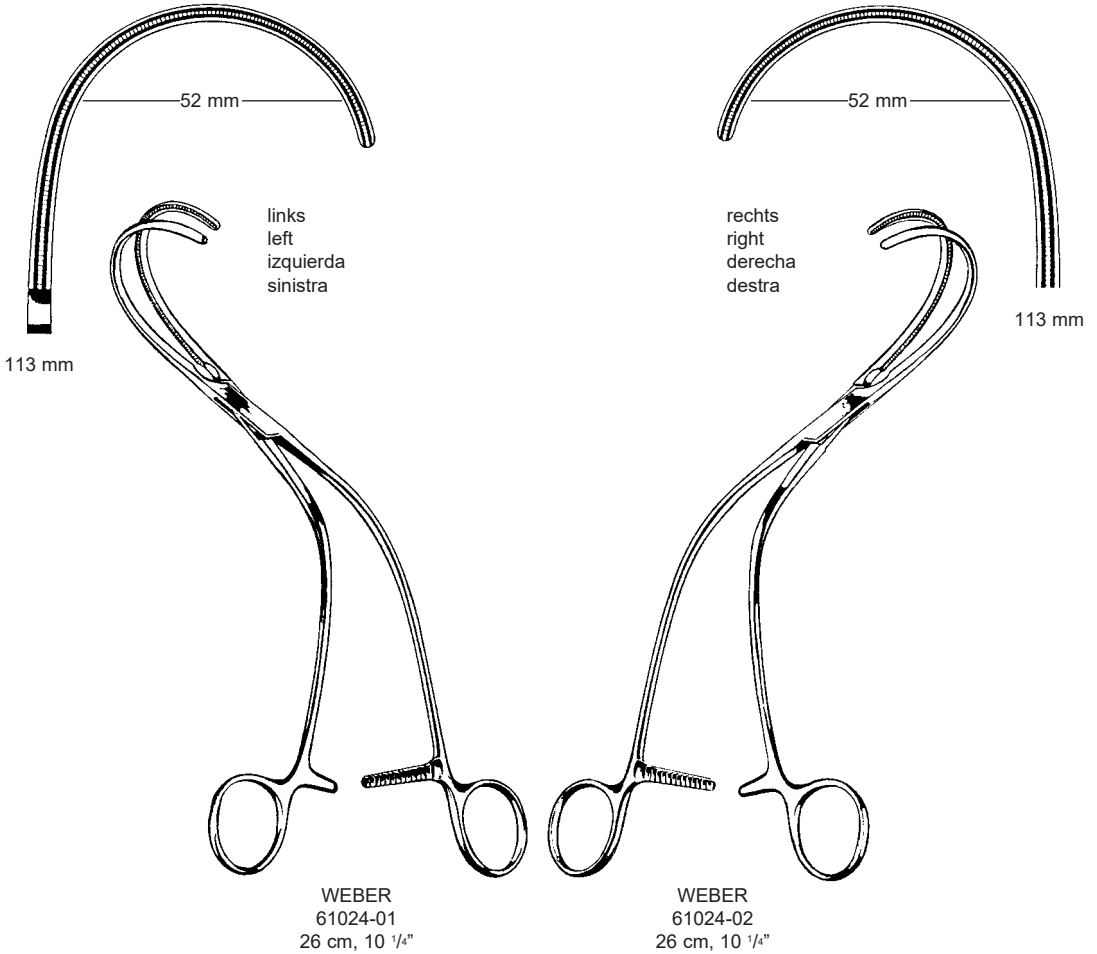
DE BAKEY
61023-25
25 cm, 10"



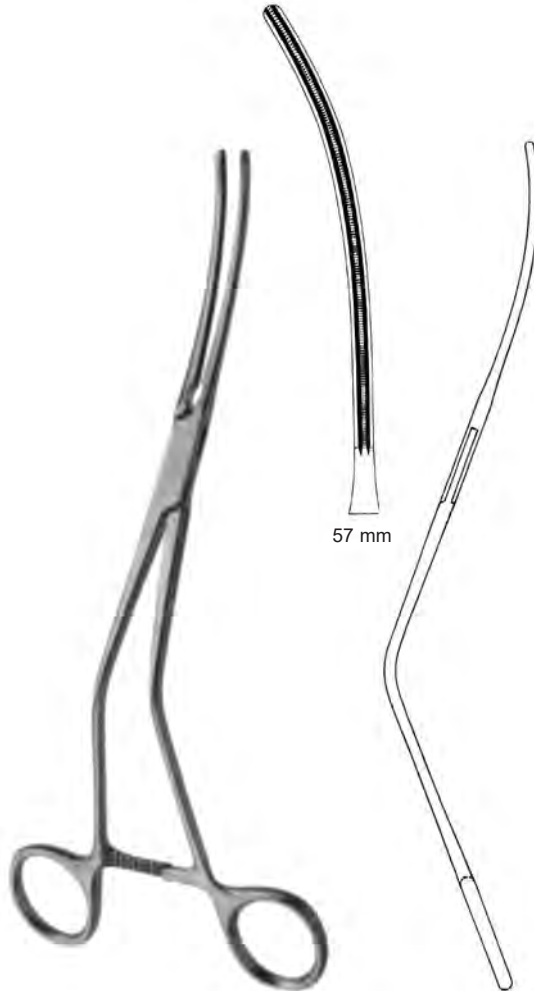
DE BAKEY
61023-26
26 cm, 10 1/4"

Atrauma

Aortaklemmen
Aortic clamps
Pinzas-clamps para la aorta
Pinze per aorta



Aortaklemmen
Aortic clamps
Pinzas-clamps para la aorta
Pinze per aorta

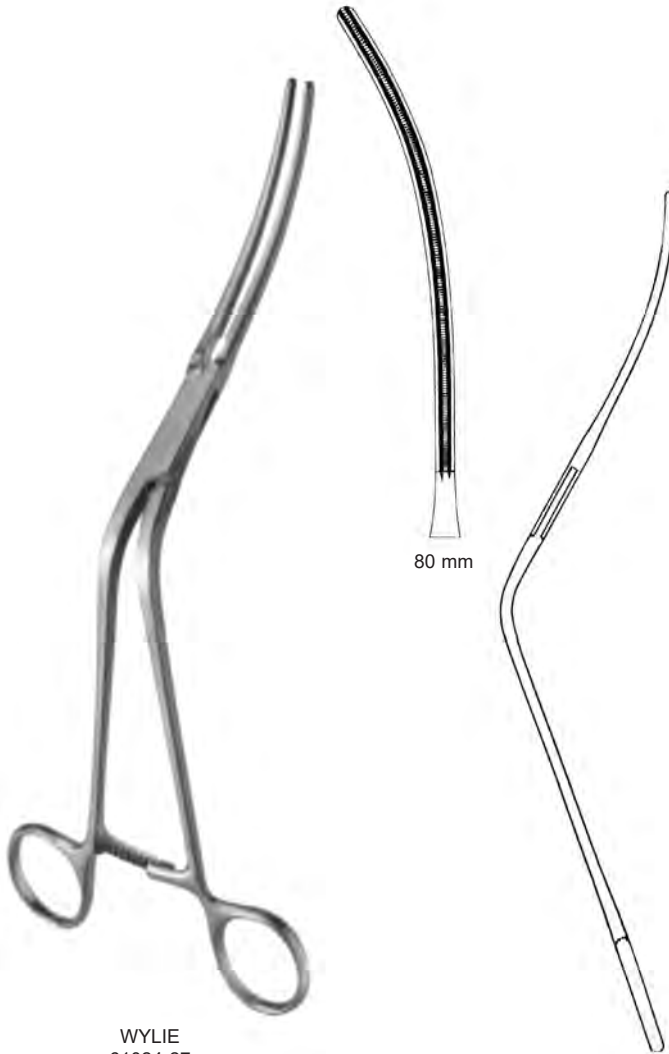


57 mm

WYLIE
61024-24
24 cm, 9 1/2"

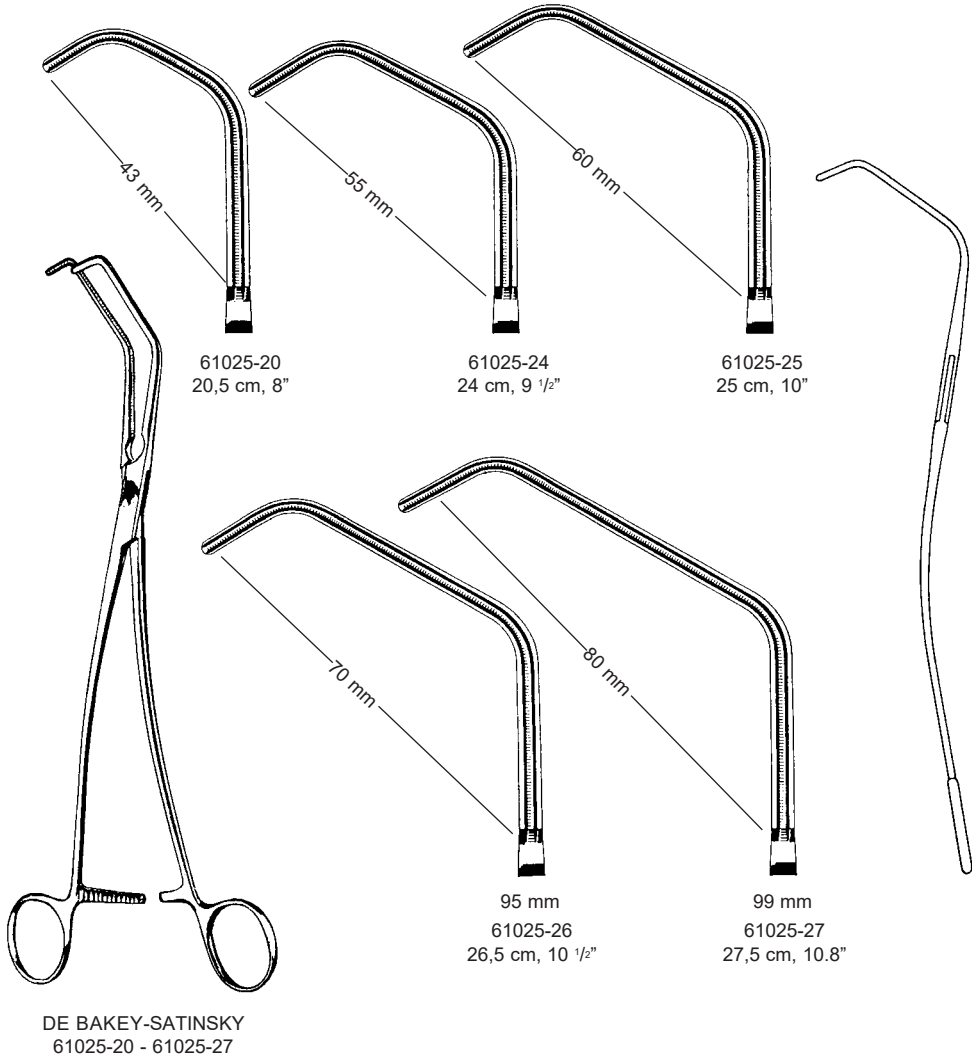
Atrauma

Aortaklemmen
Aortic clamps
Pinzas-clamps para la aorta
Pinze per aorta



WYLIE
61024-27
27 cm, 10 1/2"

Tangentialklemmen
 Tangential occlusion clamps
 Pinzas-clamps para oclusión tangencial
 Pinze per occlusione tangenziale

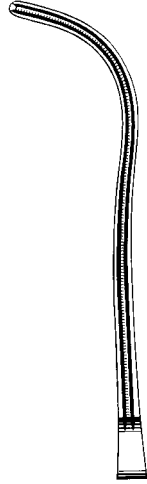


Atrauma

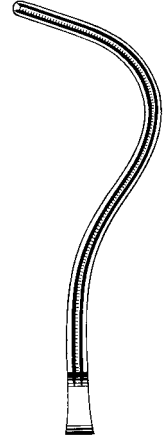
Aurikelklemmen
 Auricle clamps
 Pinza-clamps auriculares
 Pinza auricula



HARKEN
 61026-01 - 61026-04



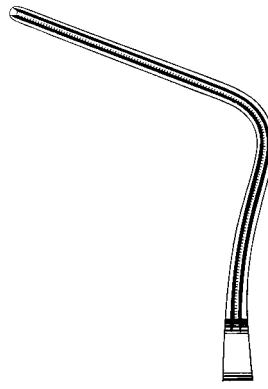
86 mm
 61026-01
 24 cm, 9 1/2"



86 mm
 61026-02
 24 cm, 9 1/2"



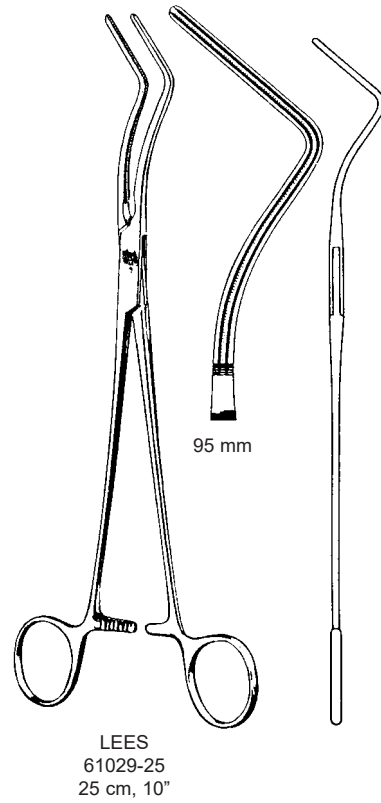
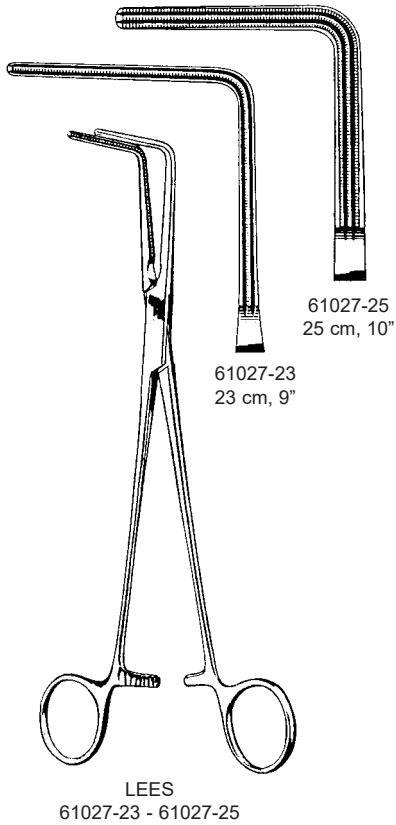
86 mm
 61026-03
 24 cm, 9 1/2"



86 mm
 61026-04
 24 cm, 9 1/2"

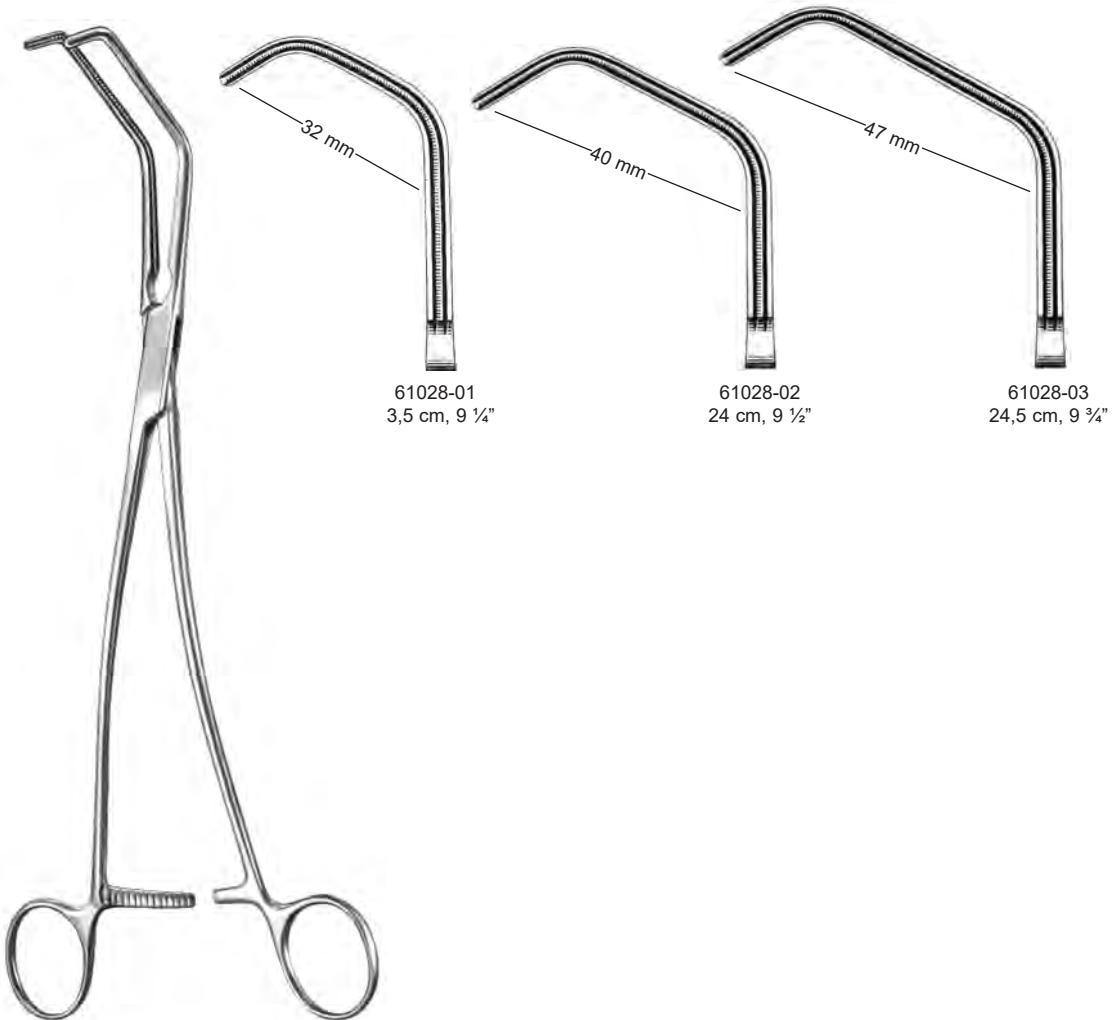


Bronchusklemmen
 Bronchus clamp
 Pinzas-clamps bronquiales
 Pinze per bronchi

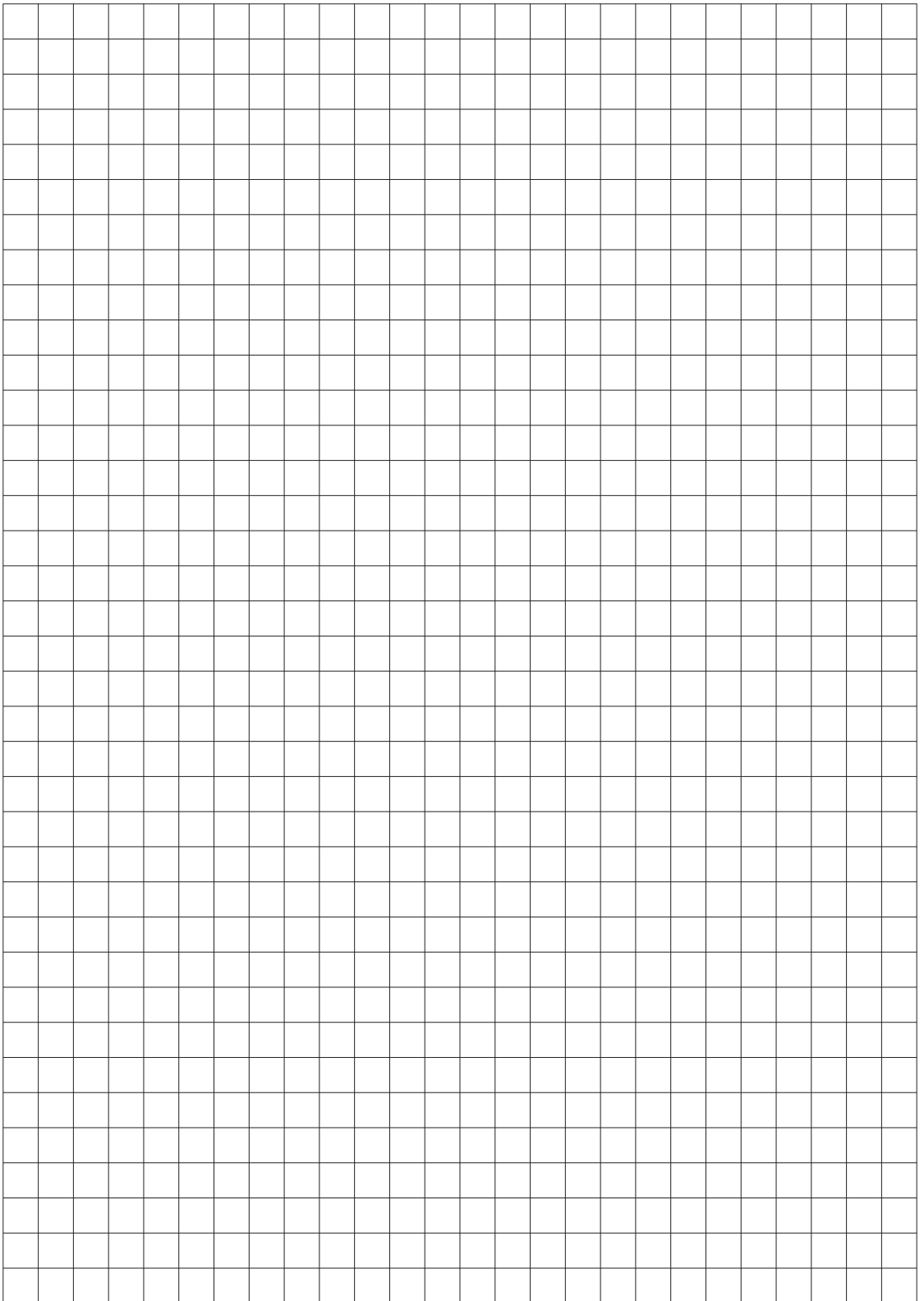


Atrauma

Präparier- und Ligaturklemmen
Dissecting- and Ligature clamps
Pinza para disección y ligatura
Pinze per dissezione e legature

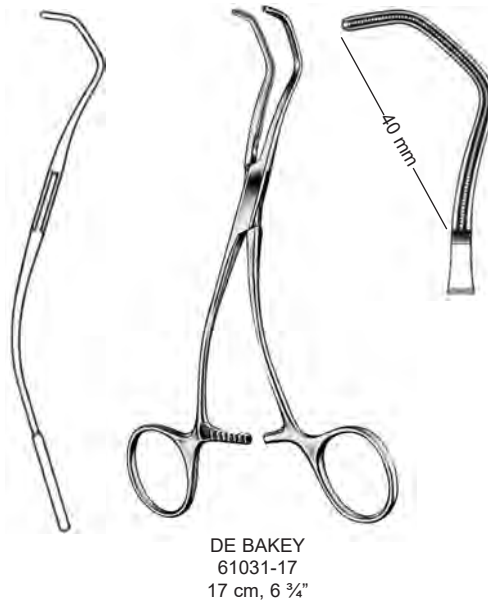
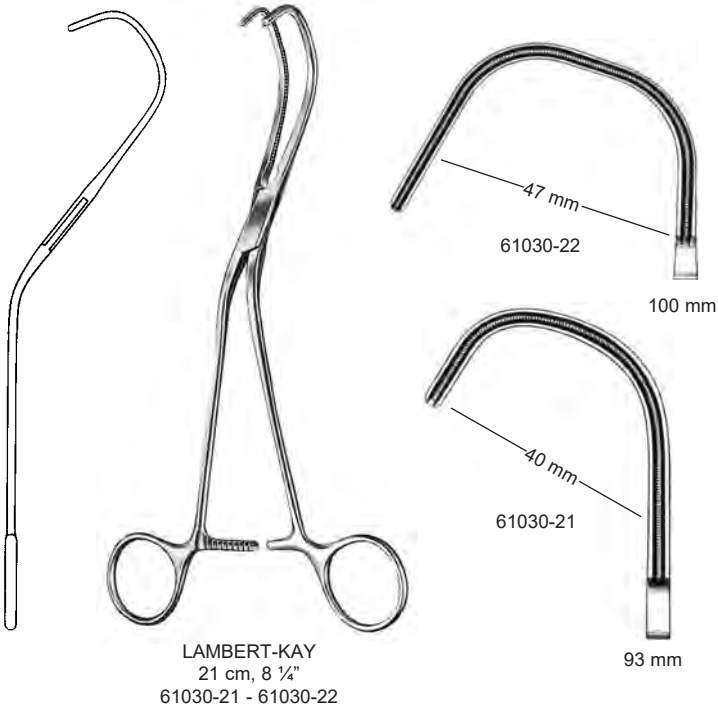


DE BAKEY SATINSKY

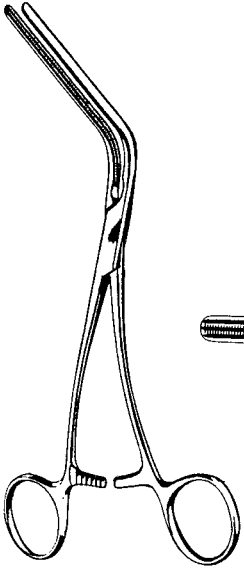


Atrauma

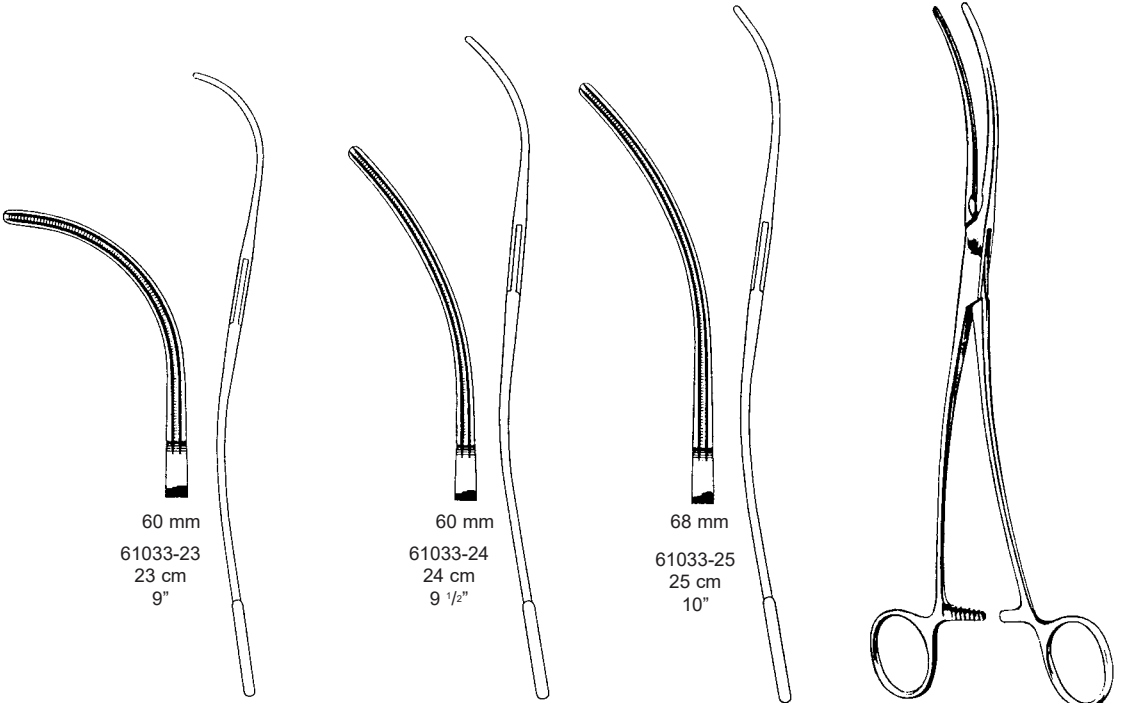
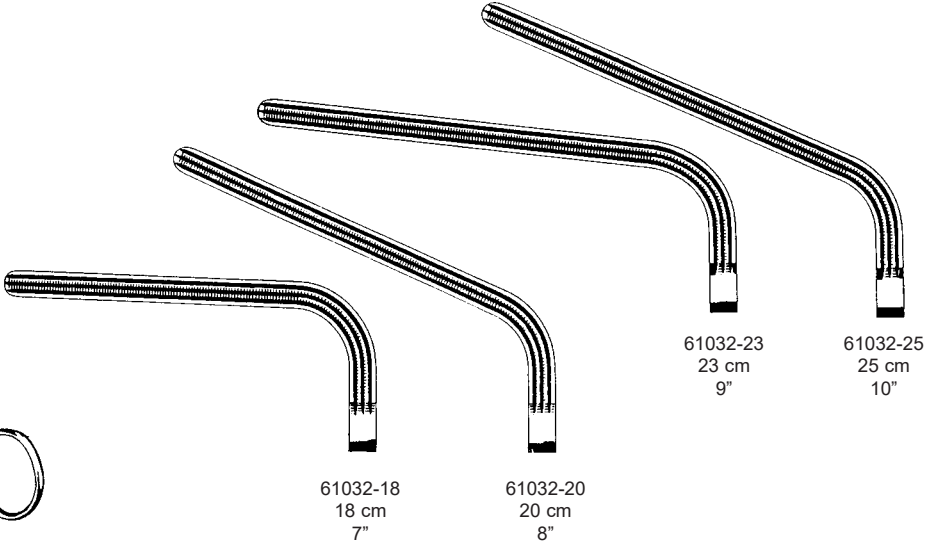
Aorta-Anastomosenklemmen
 Aortic anastomosis Clamps
 Pinzas-clamps para anastomosis
 Pinze anastomosi aorta



Aorta- und Aneurysmaklemme
 Aortic- and Aneurysm Clamps
 Pinzas aórticas y para aneurisma
 Pinze per aorta e per aneurisma



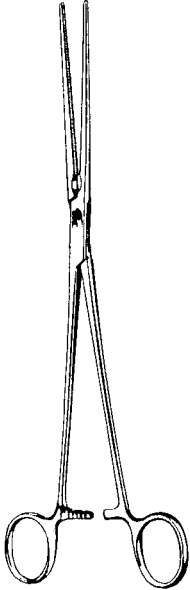
MORRIS-DE BAKEY
 61032-18 - 61032-25



DE BAKEY-BAHNSON
 61033-23 - 61033-25

Atrauma

Mehrzweck-Gefäßklemme
Multi purpose Vascular Clamps
Pinzas vasculares de usos multiples
Pinze vascolari universali



DE BAKEY
61034-21 - 61034-31



53 mm
61034-21
21,5 cm
8 1/2"



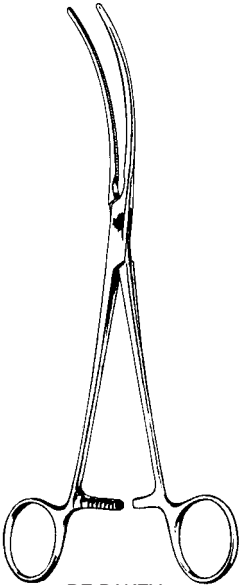
68 mm
61034-23
23 cm
9"



75 mm
61034-27
27 cm
10 1/2"



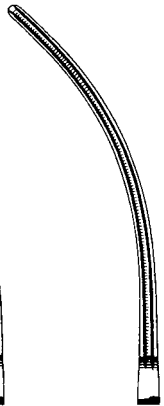
112 mm
61034-31
31,5 cm
12 1/2"



DE BAKEY
61035-21 - 61035-31



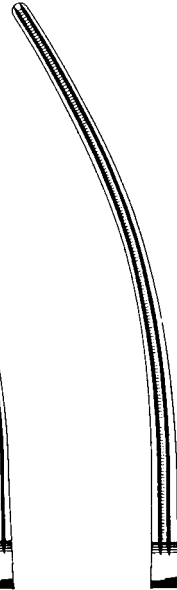
60 mm
61035-21
21,5 cm
8 1/2"



77 mm
61035-23
23 cm
9"

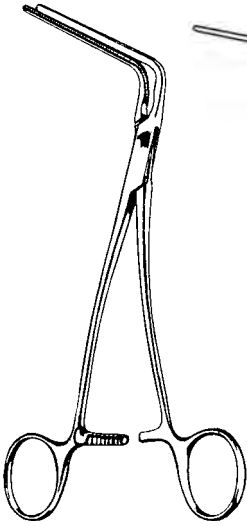


89 mm
61035-27
27 cm
10 1/2"

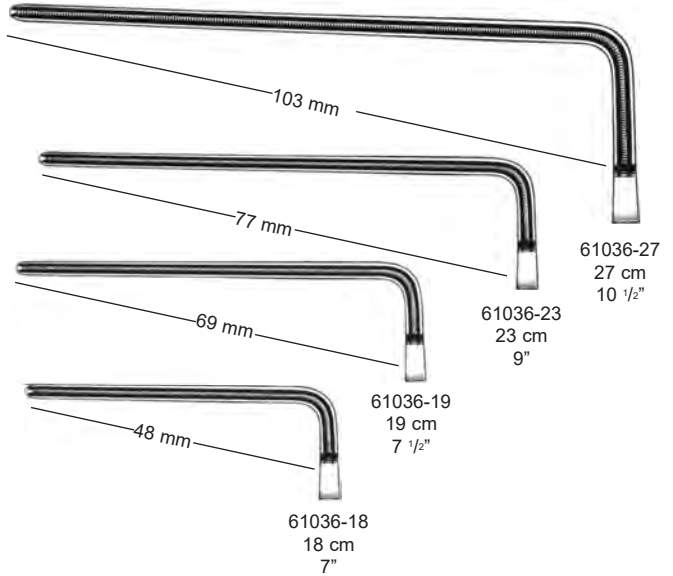


111 mm
61035-31
31 cm
12 1/4"

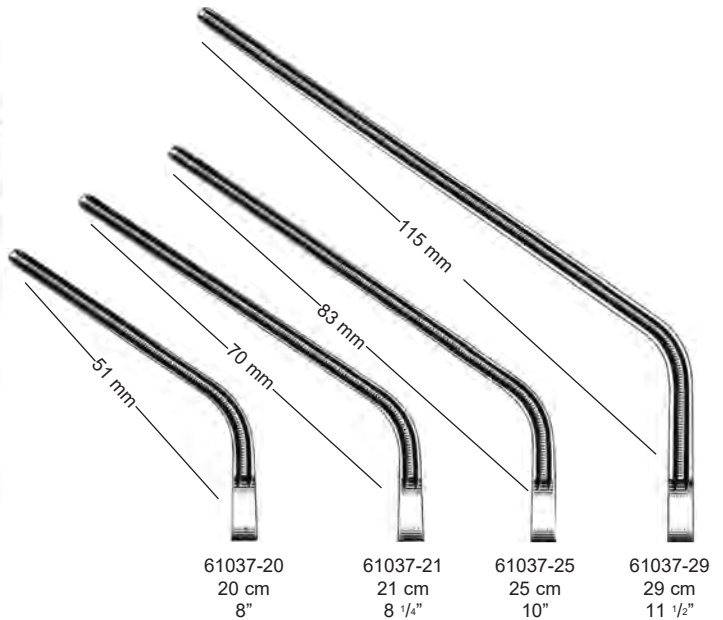
Mehrzweck-Gefäßklemme
 Multi purpose Vascular Clamps
 Pinzas vasculares de usos multiples
 Pinze vascolari universali



DE BAKEY
 61036-18 - 61036-27

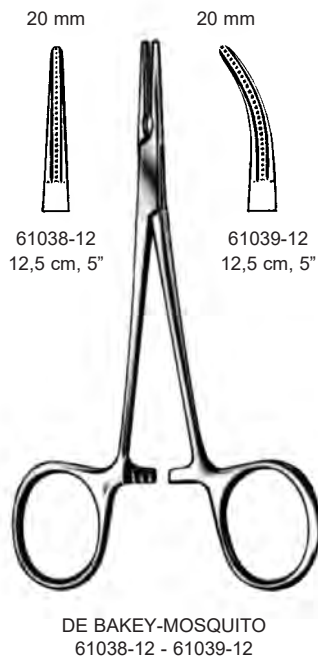


DE BAKEY
 61037-20 - 61037-29



Atrauma

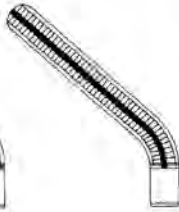
Arterienklemmen
Hemostatic forceps
Pinzas hemostáticas
Pinze emostatiche



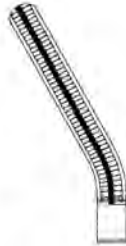
Mehrzweck-Gefäßklemme
Multi purpose Vascular Clamps
Pinzas vasculares de usos múltiples
Pinze vascolari universali



38 mm
61039-90
13 cm
5 1/4"
90°



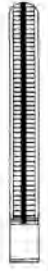
38 mm
61039-45
15 cm
6"
45°



38 mm
61039-30
15 cm
5 1/2"
30°



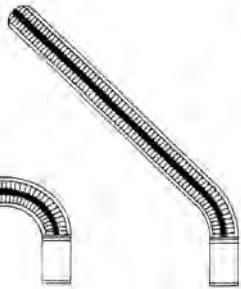
38 mm
61039-15
15 cm
5 1/2"
15°



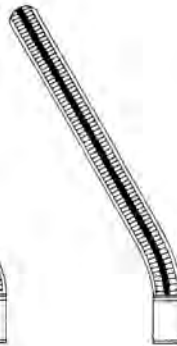
38 mm
61039-00
15 cm
5 1/2"



58 mm
61041-90
13,5 cm
5 1/4"
90°



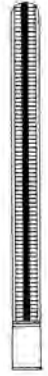
58 mm
61041-45
16 cm
6 1/4"
45°



58 mm
61041-30
17 cm
6 3/4"
30°



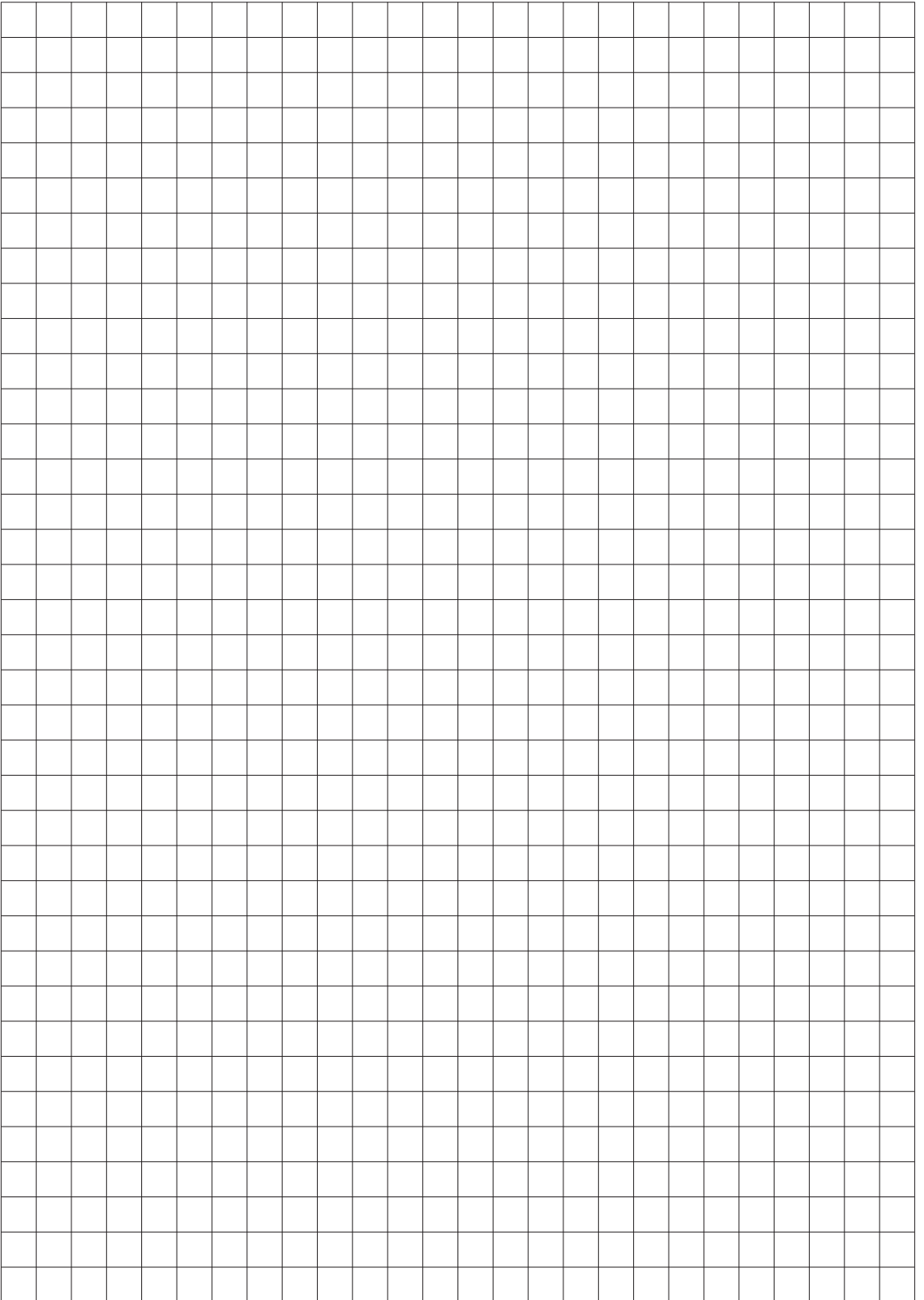
58 mm
61041-15
17 cm
6 3/4"
15°



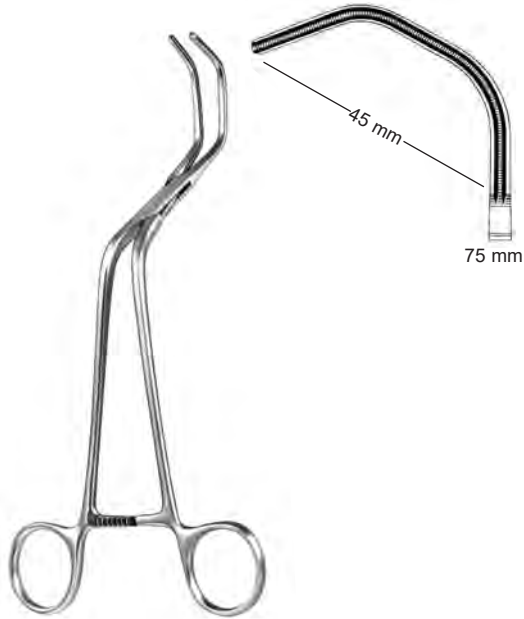
58 mm
61041-00
17 cm
6 3/4"



DARDIK



Aortaklemme, Katheterklemme
 Aortic Clamps, Catheter Clamps
 Pinzas-clamps para aorta, Pinzas para catéteres
 Pinze per aorta, Pinze per cateteri



DIETRICH
 61040-21 21 cm, 8 1/4"



COOLEY
 61050-01 - 61050-07

Charrière (French)	Länge Length Largo Lungo	
24	16 cm, 6 1/4"	61050-01
26	16 cm, 6 1/4"	61050-02
32	20 cm, 8"	61050-05
36	20 cm, 8"	61050-07

61050-01 - 61050-02
 für Kinder
 for children
 para niños
 per bambini

61050-03 - 61050-07
 für Erwachsene
 for adults
 para adultos
 per adulti

Atrauma

Carotis-Shuntklemmen
Carotid Shunt Clamps
Pinzas para shunt carótido
Pinze per carotide

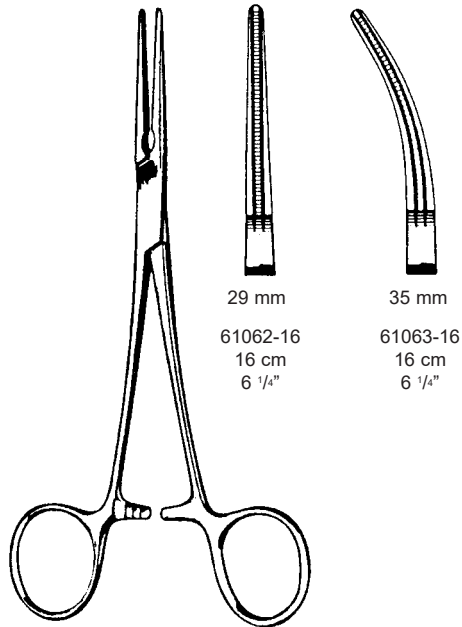


JAVID
61045-18
17,5 cm, 6.9"



JAVID
61046-19
18 cm, 7"

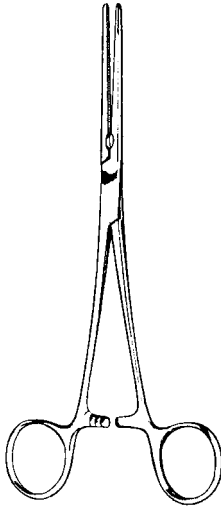
Arterienklemmen
Haemostatic Forceps
Pinzas hemostáticas
Pinze emostatiche



DE BAKEY-RANKIN
61062-16 - 61063-16

Atrauma

Arterienklemmen
Haemostatic Forceps
Pinzas hemostáticas
Pinze emostatiche



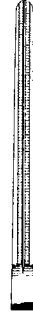
DE BAKEY-PEAN
61138-14 - 61138-20



32 mm
61138-14
14 cm
5 1/2"



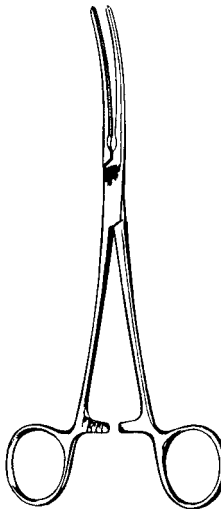
42 mm
61138-16
16 cm
6 1/4"



50 mm
61138-18
18 cm
7"



53 mm
61138-20
20 cm
8"



DE BAKEY-PEAN
61139-14 - 61139-20



38 mm
61139-14
14 cm
5 1/2"



45 mm
61139-16
16 cm
6 1/4"

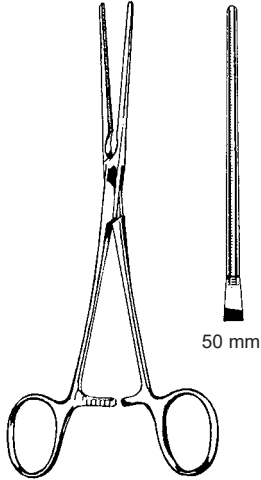


50 mm
61139-18
18 cm
7"

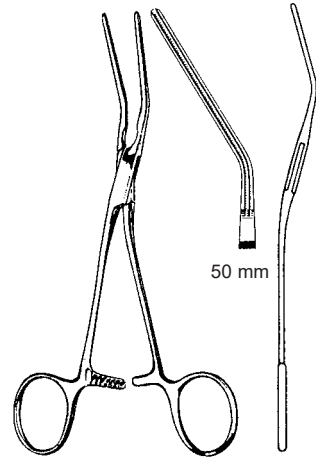


53 mm
61139-20
20 cm
8"

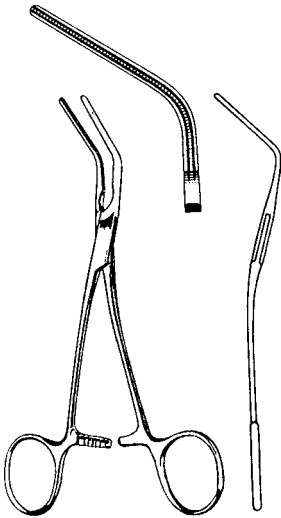
Mehrzweck-Gefäßklemmen
 Multi purpose Vascular Clamps
 Pinzas vasculares de usos múltiples
 Pinze vascolari universali



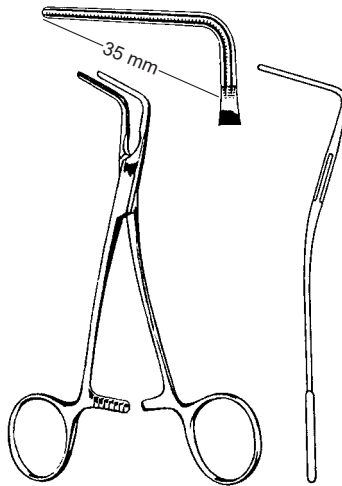
DE BAKEY
 61140-17
 17 cm, 6 ³/₄"



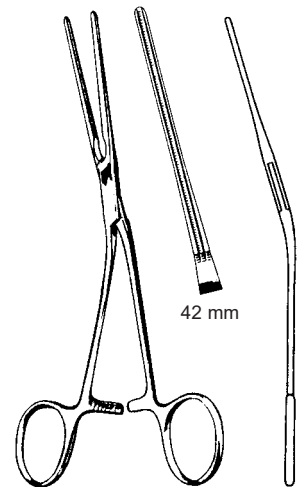
DE BAKEY
 61141-16
 16 cm, 6 ¹/₄"



DE BAKEY
 61143-15
 15 cm, 6"



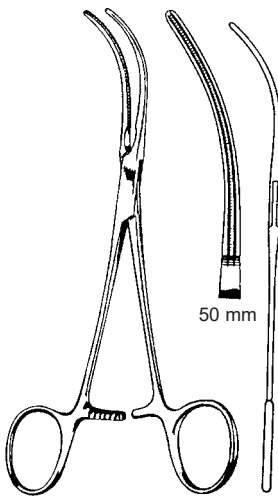
DE BAKEY
 61145-15
 15 cm, 6"



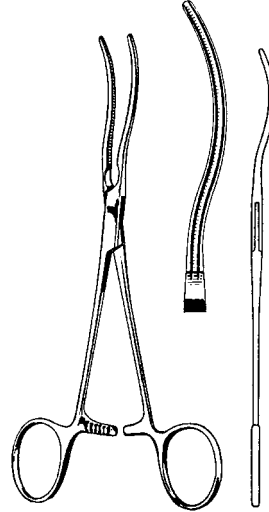
DE BAKEY
 61147-17
 17 cm, 6 ³/₄"

Atrauma

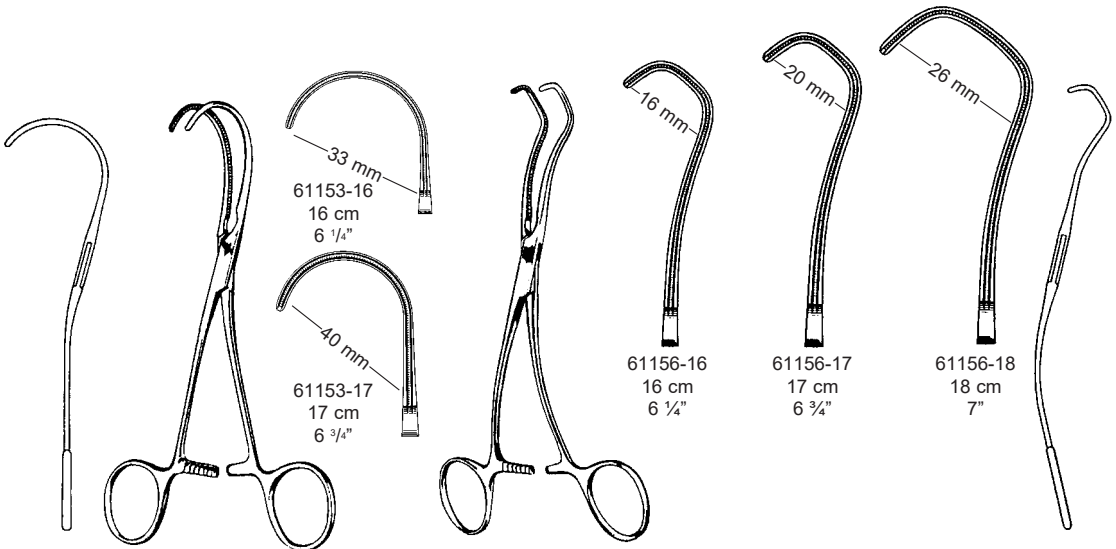
Mehrzweck-Gefäßklemmen, Anastomosenklemmen
 Multi purpose Vascular Clamps, Anastomosis Clamps
 Pinzas vasculares de usos múltiples, Pinzas para anastomosis
 Pinze vascolari universali, Pinze per anastomosi



GLOVER
 61149-17
 17 cm, 6 3/4"



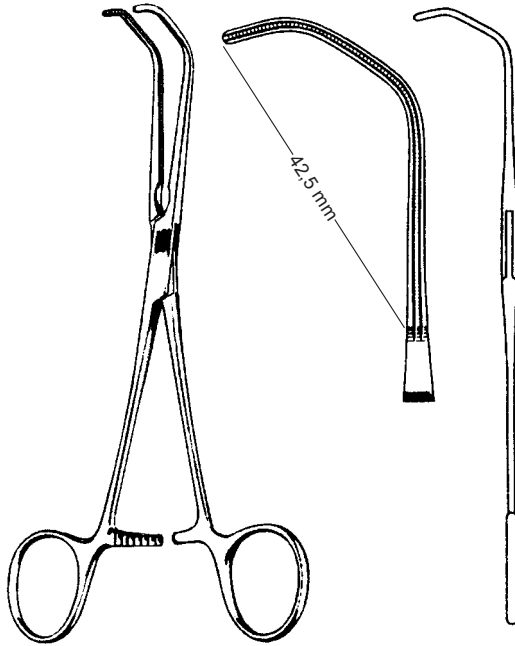
GLOVER
 61151-17
 17 cm, 6 3/4"



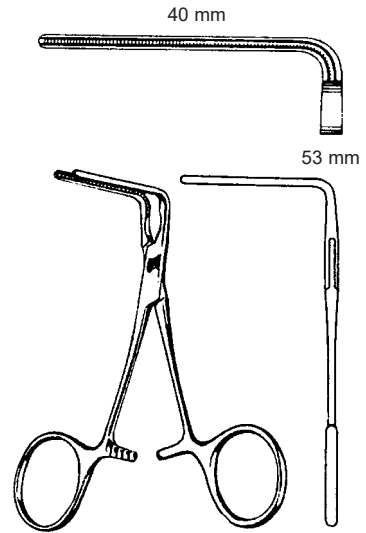
DE BAKEY
 61153-16 - 61153-17

DERRA
 61156-16 - 61156-18

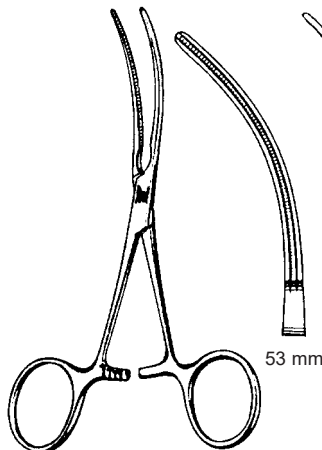
Anastomosenklemmen, Kinder-Gefäßklemmen
 Anastomosis Clamps, Pediatric Vascular Clamps
 Pinzas para anastomosis, Pinzas vasculares pediátricas
 Pinze per anastomosi, Pinze vascolari pediatriche



DE BAKEY-BECK
 61157-17 17 cm, 6 $\frac{3}{4}$ "



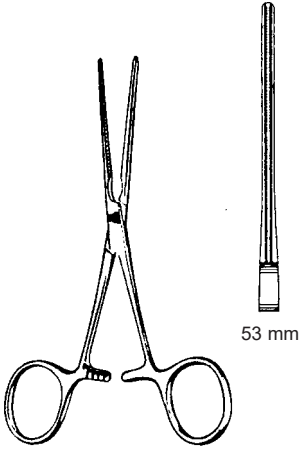
DE BAKEY
 61158-10 10 cm, 4"



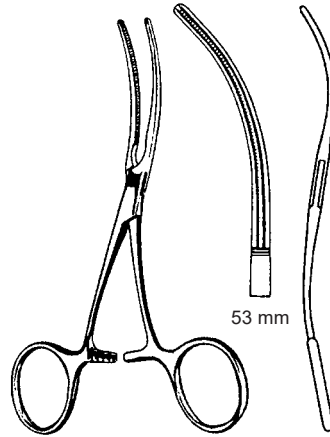
DE BAKEY
 61158-11 11 cm, 4 $\frac{3}{8}$ "

Atrauma

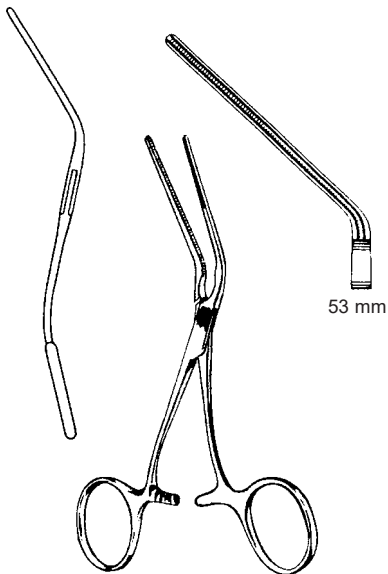
Kinder-Gefäßklemmen, Profundaklemmen
 Pediatric Vascular Clamps, Profunda Clamps
 Pinzas vasculares pediátricas, Pinzas para la profunda
 Pinze vascolari pediatriche, Pinze profunda



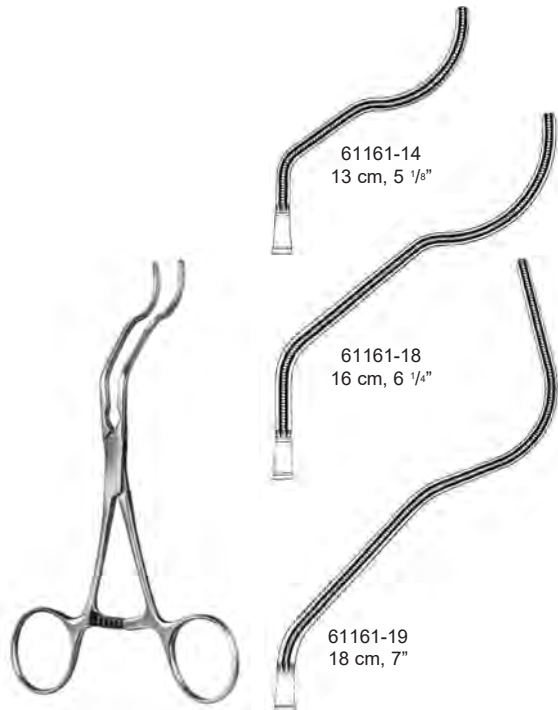
DE BAKEY
 61158-12 12 cm, 4 $\frac{3}{4}$ "



DE BAKEY
 61159-12 11,5 cm, 4 $\frac{1}{2}$ "



DE BAKEY
 61159-13 13 cm, 5 $\frac{1}{8}$ "



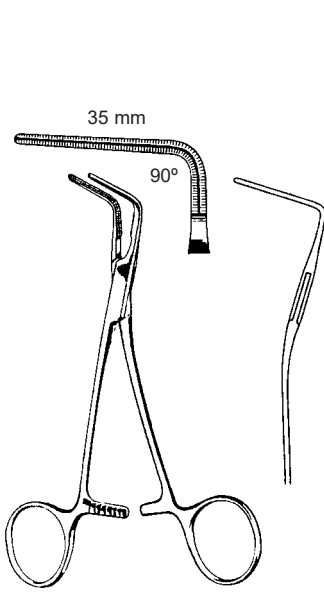
61161-14
 13 cm, 5 $\frac{1}{8}$ "

61161-18
 16 cm, 6 $\frac{1}{4}$ "

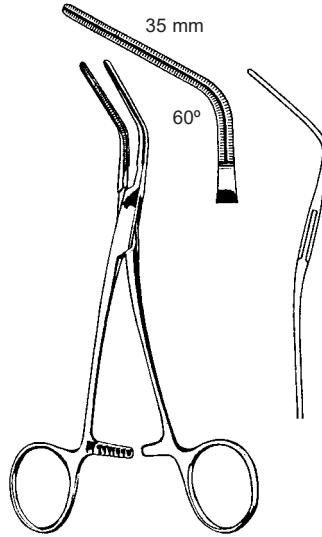
61161-19
 18 cm, 7"

GREGORY

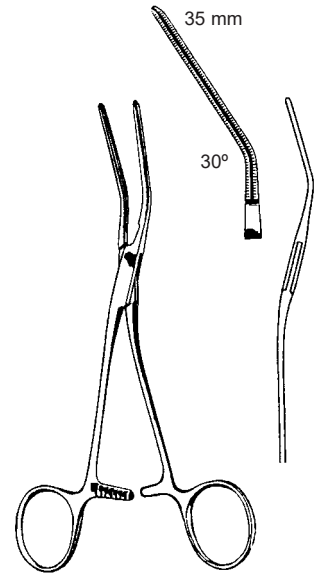
Mehrzweck-Gefäßklemmen
 Multi purpose Vascular Clamps
 Pinzas vasculares de usos múltiples
 Pinze vascolari universali



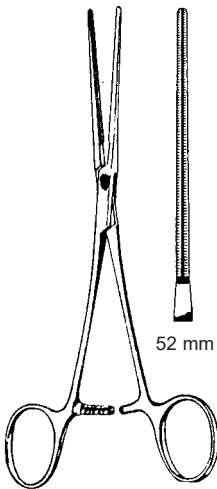
COOLEY
 61172-15
 15 cm, 6"



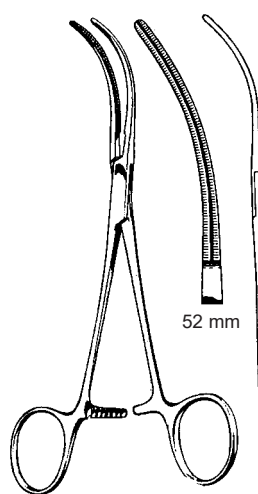
COOLEY
 61173-16
 15,5 cm, 6"



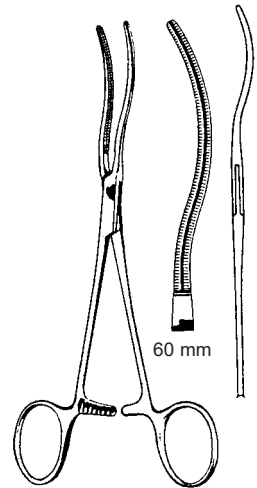
COOLEY
 61174-17
 17 cm, 6 3/4"



COOLEY
 61175-17
 17 cm, 6 3/4"



COOLEY
 61176-17
 17 cm, 6 3/4"



COOLEY
 61177-17
 17 cm, 6 3/4"

Atrauma

Mehrzweck-Gefäßklemmen
 Multi purpose Vascular Clamps
 Pinzas vasculares de usos múltiples
 Pinze vascolari universali



COOLEY-DERRA
 61178-16 - 61179-18



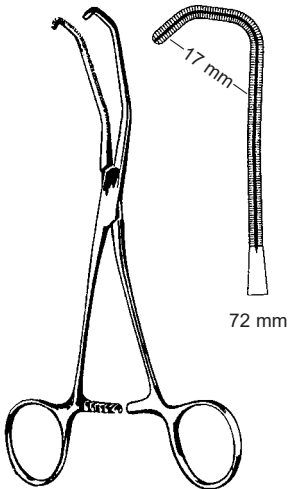
71 mm
 61178-16
 16 cm
 6 1/4"



76 mm
 61178-17
 17 cm
 6 3/4"



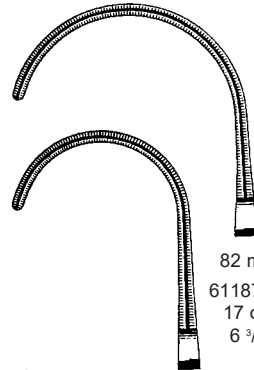
80 mm
 61179-18
 18 cm
 7"



COOLEY
 61180-17
 17 cm, 6 3/4"



COOLEY
 61187-16 - 61187-17

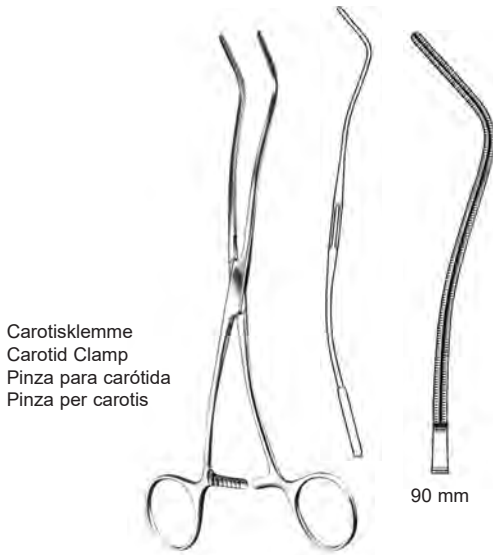


82 mm
 61187-17
 17 cm
 6 3/4"

82 mm
 61187-16
 16 cm
 6 1/4"

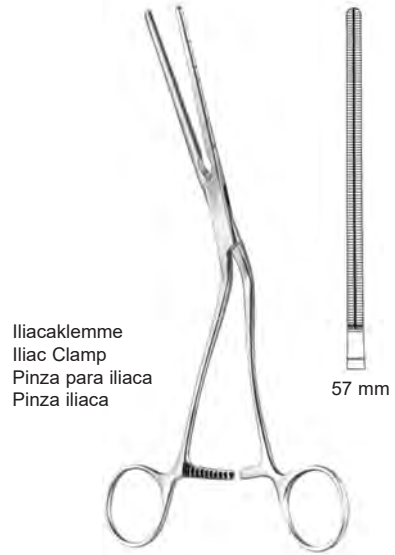


Anastomosenklemmen, Mehrzweck-Gefäßklemme
 Anastomosis Clamp, Multi purpose Vascular Clamps
 Pinza clamp para iliac y anastomosis, Pinzas vasculares de usos multiples
 Pinze anastomosi, Pinze vascolari universali



Carotisklemme
 Carotid Clamp
 Pinza para carótida
 Pinza per carotis

COOLEY
 61188-20 20 cm, 8"



Iliacaklemme
 Iliac Clamp
 Pinza para iliaca
 Pinza iliaca

COOLEY
 61189-21 21 cm, 8 1/4"



BECK
 61190-17 17 cm, 6 3/4"



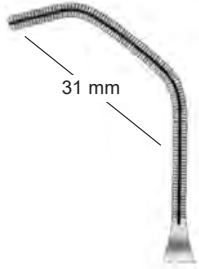
COOLEY
 61191-16 16 cm, 6 1/4"



COOLEY
 61192-17 17 cm, 6 3/4"

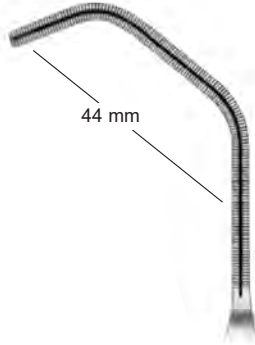
Atrauma

Anastomosenklemmen
 Anastomosis Clamp
 Pinza clamp para iliac y anastomosis
 Pinze anastomosi



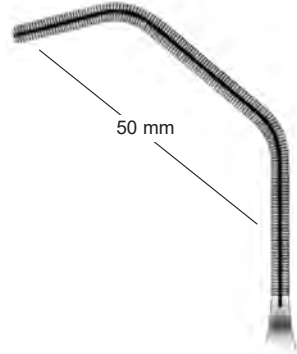
31 mm

61193-01
 20,5 cm, 8"



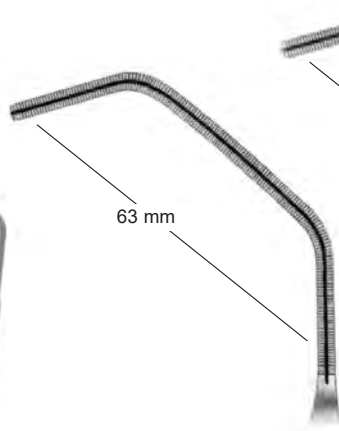
44 mm

61193-02
 26 cm, 10 1/4"



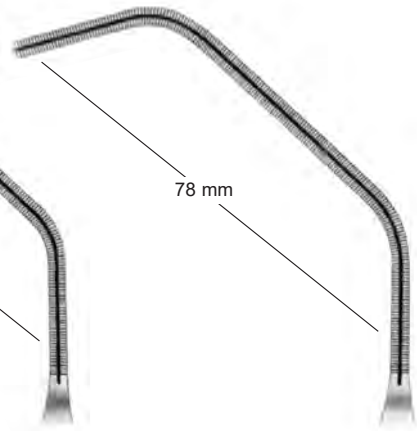
50 mm

61193-03
 26,5 cm, 10 1/2"



63 mm

61193-04
 26,5 cm, 10 1/2"



78 mm

61193-05
 27,5 cm, 10 3/4"



COOLEY

Mehrzweck-Gefäßklemme
 Multi purpose Vascular Clamps
 Pinzas vasculares de usos multiples
 Pinze vascolari universali



COOLEY
 61194-26 26 cm, 10 $\frac{3}{4}$ "



COOLEY
 61195-28 28,5 cm, 11 $\frac{1}{4}$ "

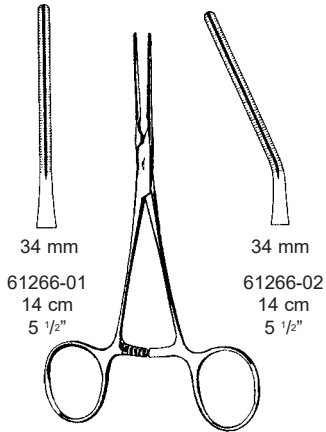
Atrauma

Anastomosenklemmen
Anastomosis Clamp
Pinza clamp para iliac y anastomosis
Pinze anastomosi

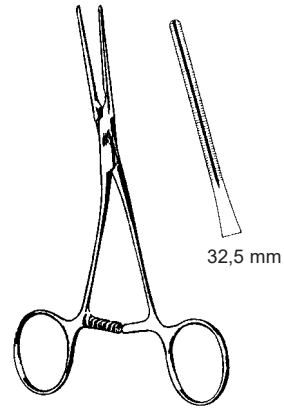


COOLEY
61196-26 26 cm, 10 1/4"

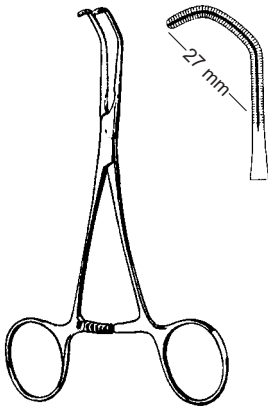
Kinder-Gefäßklemmen
 Pediatric Vascular Clamps
 Pinzas vasculares pediátricas
 Pinze vascolari pediatriche



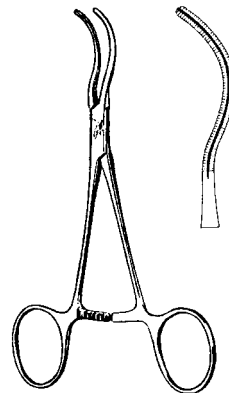
COOLEY
 61266-01 - 61266-02
 14 cm, 5 1/2"



COOLEY
 61266-03 14 cm, 5 1/2"



COOLEY
 61266-04 14 cm, 5 1/2"



COOLEY
 61266-05 14 cm, 5 1/2"

Atrauma

Kinder-Gefäßklemmen Pediatric Vascular Clamps Pinzas vasculares pediátricas Pinze vascolari pediatriche

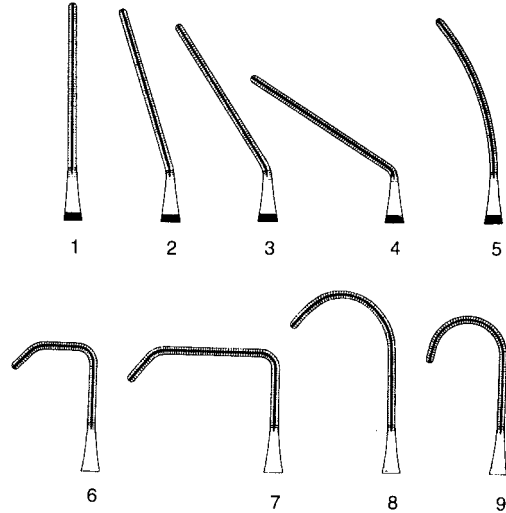
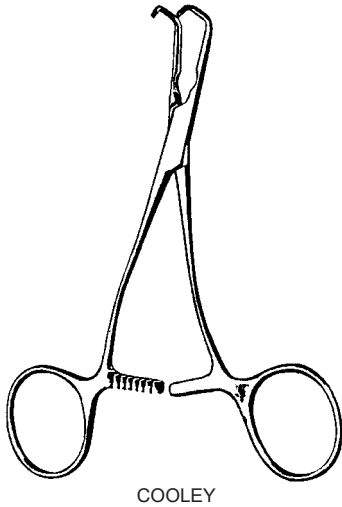


Fig.	gerade straight rectas rette
1	61372-01 14 cm, 5 1/2"
2	61372-02 14 cm, 5 1/2"
3	61372-03 14 cm, 5 1/2"
4	61372-04 13 cm, 5 1/8"
5	61372-05 14 cm, 5 1/2"
6	61372-06 13 cm, 5 1/8"
7	61372-07 13 cm, 5 1/8"
8	61372-08 14 cm, 5 1/2"
9	61372-09 13,5 cm, 5 1/4"



Fig.	stark abgewinkelt strongly angled ramas anguladas forte angolata
1	61373-01 14 cm, 5 1/2"
2	61373-02 14 cm, 5 1/2"
3	61373-03 14 cm, 5 1/2"
4	61373-04 13 cm, 5 1/8"
5	61373-05 14 cm, 5 1/2"
6	61373-06 13 cm, 5 1/8"
7	61373-07 13 cm, 5 1/8"
8	61373-08 14 cm, 5 1/2"
9	61373-09 13,5 cm, 5 1/4"

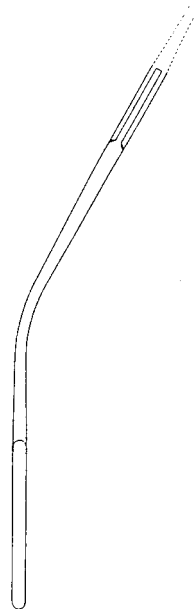


Fig.	abgewinkelt angled acodadas angolata
1	61374-01 14 cm, 5 1/2"
2	61374-02 14 cm, 5 1/2"
3	61374-03 14 cm, 5 1/2"
4	61374-04 13 cm, 5 1/8"
5	61374-05 14 cm, 5 1/2"
6	61374-06 13 cm, 5 1/8"
7	61374-07 13 cm, 5 1/8"
8	61374-08 14 cm, 5 1/2"
9	61374-09 13,5 cm, 5 1/4"



Clipanlegezangen für die offene Chirurgie 25° aufgebogen
 Clip Appliers for open Surgery 25° upcurved
 Pinza applicadora de clips para cirugía abierta con ángulo de 25°
 Pinza applicatore clips per chirurgia aperto, curvo in alto 25°



15 cm, 6"

SLS Clips

61464-15 Micro weiss / white / blanc / blanco / bianco
 61465-15 Small gelb / yellow / jaune / amarillo / giallo
 61466-15 Small medium lila / lilac / lilas / lila / lilla
 61467-15 Medium blau / blue / bleu / azul / blu

Ethicon

61470-15 Small blau / blue / bleu / azul / blu
 61471-15 Medium weiss / white / blanc / blanco / bianco

Pilling

61481-15 Small gelb / yellow / jaune / amarillo / giallo
 61482-15 Medium blau / blue / bleu / azul / blu

Horizon

61460-19 Small gelb / yellow / jaune / amarillo / giallo
 61461-19 Medium blau / blue / bleu / azul / blu
 61462-19 Medium Large grün / green / verde / verde
 61463-19 Large orange / naranja / arancione

SLS Clips

61464-19 Micro weiss / white / blanc / blanco / bianco
 61465-19 Small gelb / yellow / jaune / amarillo / giallo
 61466-19 Small medium lila / lilac / lilas / lila / lilla
 61467-19 Medium blau / blue / bleu / azul / blu
 61468-19 Medium Large grün / green / verde / verde
 61469-19 Large orange / naranja / arancione

Ethicon

61470-19 Small blau / blue / bleu / azul / blu
 61471-19 Medium weiss / white / blanc / blanco / bianco
 61472-19 Medium Large grün / green / verde / verde
 61473-19 Large gelb / yellow / jaune / amarillo / giallo

Pilling

61481-19 Small gelb / yellow / jaune / amarillo / giallo
 61482-19 Medium blau / blue / bleu / azul / blu
 61484-19 Medium Large grün / green / verde / verde
 61483-19 Large orange / naranja / arancione



19 cm, 7 1/2"

Clipanlegezangen für die offene Chirurgie 25° aufgebogen
 Clip Appliers for open Surgery 25° upcurved
 Pinza aplicadora de clips para cirugía abierta con ángulo de 25°
 Pinza applicatore clips per chirurgia aperto, curvo in alto 25°

Horizon

61461-28 Medium blau / blue / bleu / azul / blu
 61462-28 Medium Large grün / green / verde / verde
 61463-28 Large orange / naranja / arancione

SLS Clips

61464-28 Micro weiss / white / blanco / bianco
 61465-28 Small gelb / yellow / jaune / amarillo / giallo
 61466-28 Small medium lila / lilac / lilas / lila / lilla
 61467-28 Medium blau / blue / bleu / azul / blu
 61468-28 Medium Large grün / green / verde / verde
 61469-28 Large orange / naranja / arancione

Ethicon

61471-28 Medium weiss / white / blanco / bianco
 61472-28 Medium Large grün / green / verde / verde
 61473-28 Large gelb / yellow / jaune / amarillo / giallo

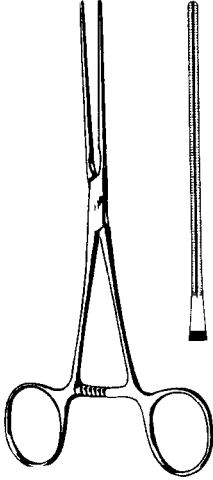
Pilling

61482-28 Medium blau / blue / bleu / azul / blu
 61484-28 Medium Large grün / green / verde / verde
 61483-28 Large orange / naranja / arancione

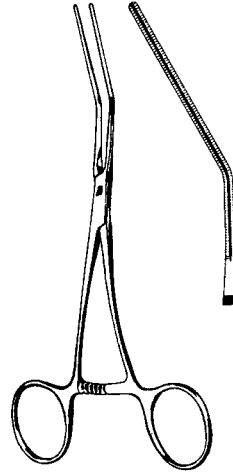


28 cm, 11"

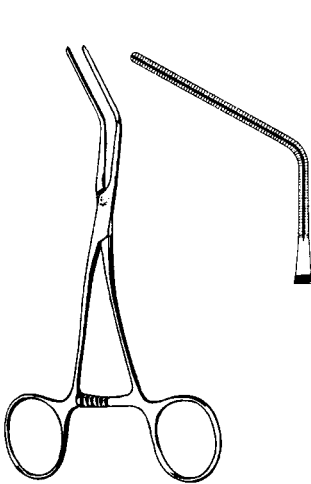
Kinder-Gefäßklemmen
 Pediatric Vascular Clamps
 Pinzas vasculares pediátricas
 Pinze vascolari pediatriche



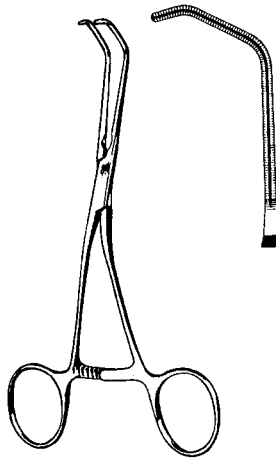
61488-16
 16,5 cm, 6 1/2"



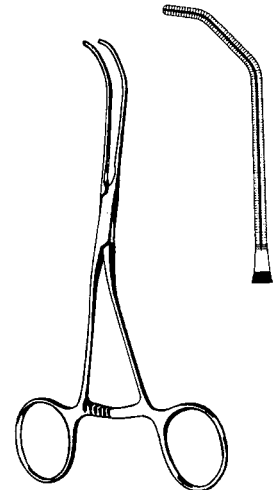
61489-16
 16 cm, 6 1/4"



61490-15
 15 cm, 6"

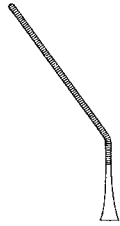


61491-15
 15 cm, 6"

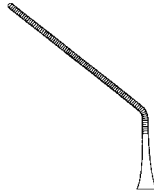


61492-16
 15,5 cm, 6"

Kinder-Gefäßklemmen
 Pediatric Vascular Clamps
 Pinzas vasculares pediátricas
 Pinze vascolari pediatriche



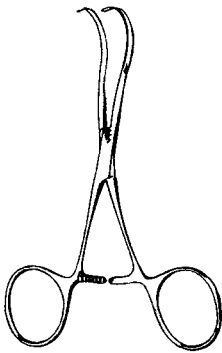
61493-01
 13 cm
 5 1/8"



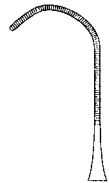
61493-02
 13 cm
 5 1/8"



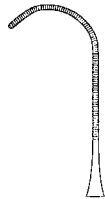
61493-03
 11 cm
 4 3/8"



CASTANEDA
 61493-01 - 61495-04



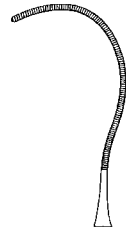
61495-01
 12 cm
 4 3/4"



61495-02
 12 cm
 4 3/4"



61495-03
 12 cm
 4 3/4"



61495-04
 12 cm
 4 3/4"

Tourniquets
 Tourniquets
 Tourniquets
 Tornichetti

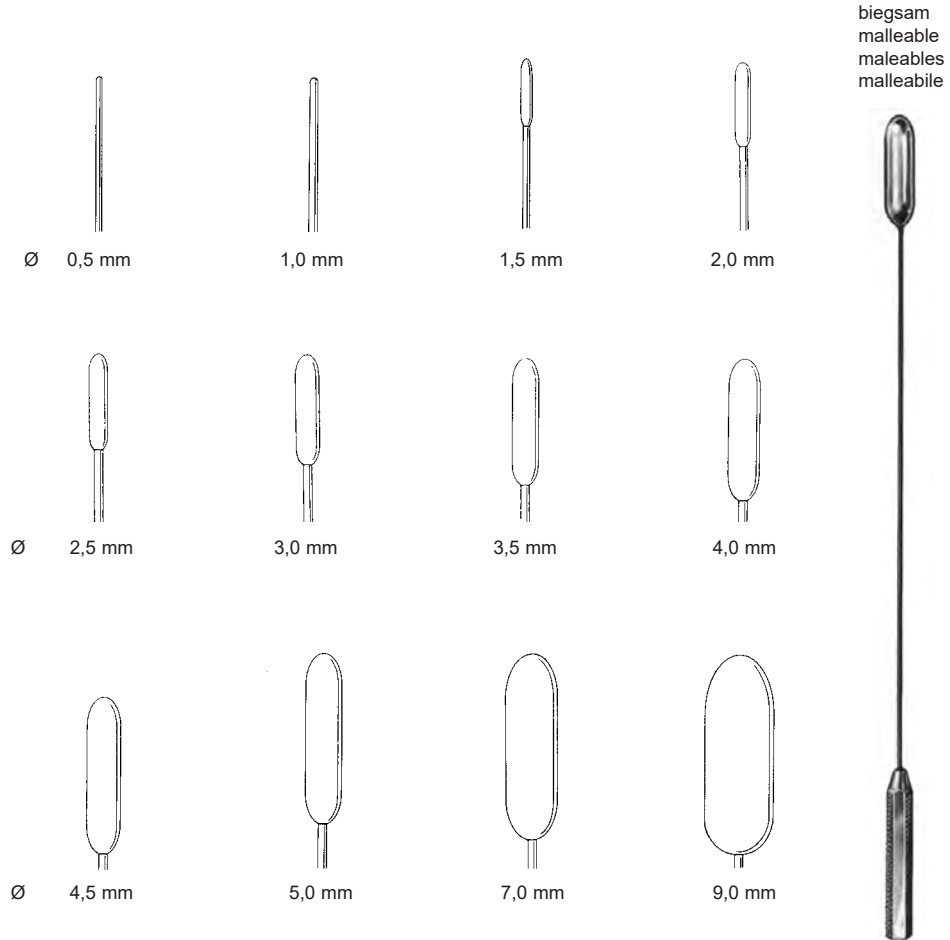


61700-01
 61710-01
 Mandrin alleine
 Guide only
 Guida sola



RUMEL-BELMONT
 61700-33 3,2 mm Ø
 61710-33 6,4 mm Ø
 33 cm, 13"
 flexibel, flexible,
 flexible, flessibile

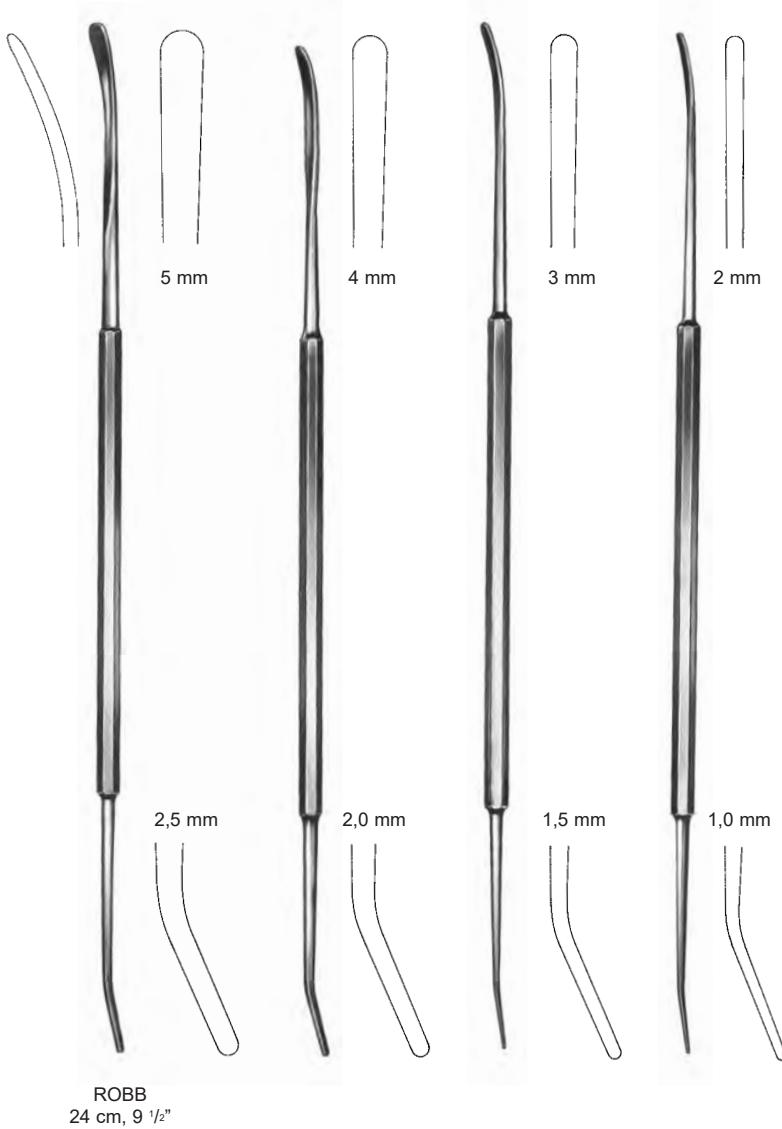
Gefäß-Dilatatoren
 Vascular Dilators
 Dilatadores vasculares
 Dilatatori vascolari



DE BAKEY / GARRETT

15 cm, 6"	19 cm, 7½"	Ø mm	35 cm, 13¾"
61805-05	61810-05	0,5	61820-05
61805-10	61810-10	1,0	61820-10
61805-15	61810-15	1,5	61820-15
61805-20	61810-20	2,0	61820-20
61805-25	61810-25	2,5	61820-25
61805-30	61810-30	3,0	61820-30
61805-35	61810-35	3,5	61820-35
61805-40	61810-40	4,0	61820-40
61805-45	61810-45	4,5	61820-45
61805-50	61810-50	5,0	61820-50
61805-70	61810-70	7,0	61820-70
61805-90	61810-90	9,0	61820-90

Gefäßdissektoren
 Vascular Dissectors
 Disecadores vasculares
 Dissettori vascolari



ROBB
 24 cm, 9 1/2"

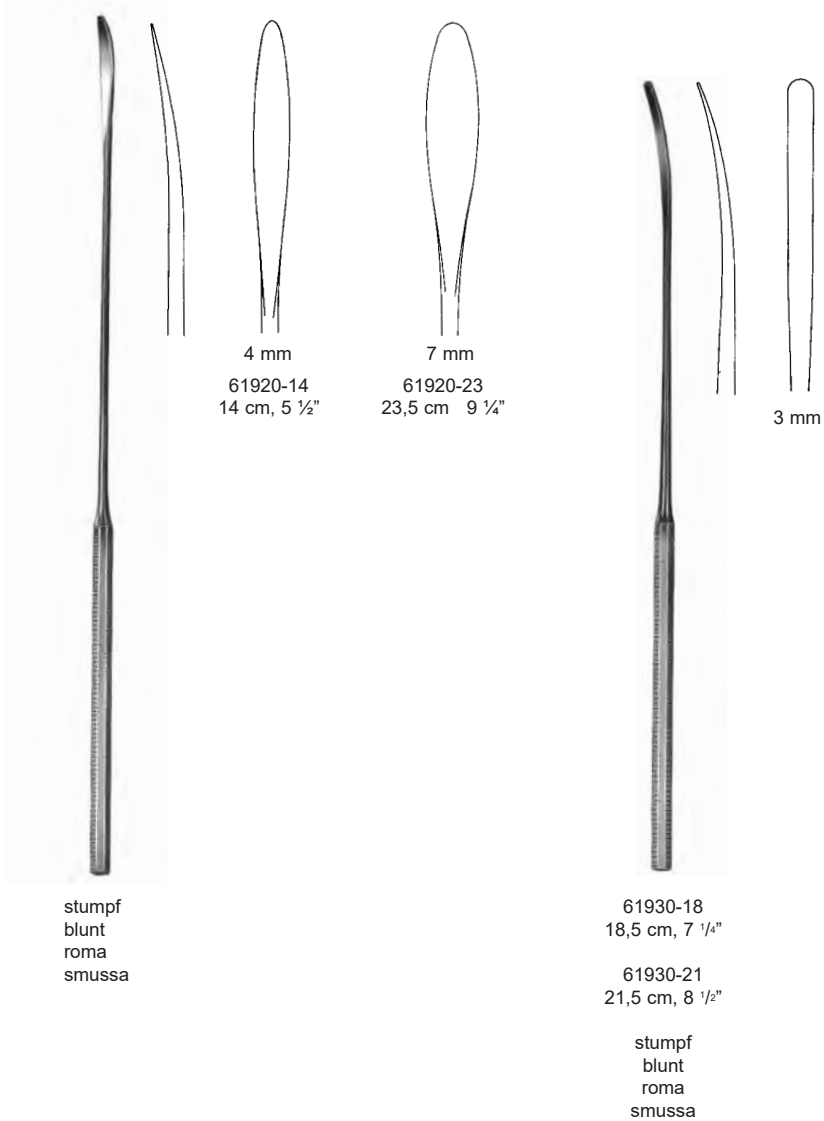
Fig. 1
 61910-01

Fig. 2
 61910-02

Fig. 3
 61910-03

Fig. 4
 61910-04

Intimaspatel
Intima Spatulas
Espátulas para la intima
Spatole per intima



Gallensteinzangen
 Gall Stone Forceps
 Pinzas para cálculos biliares
 Pinze per calcoli biliari



DESJARDINS
 23 cm, 9"

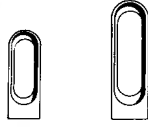
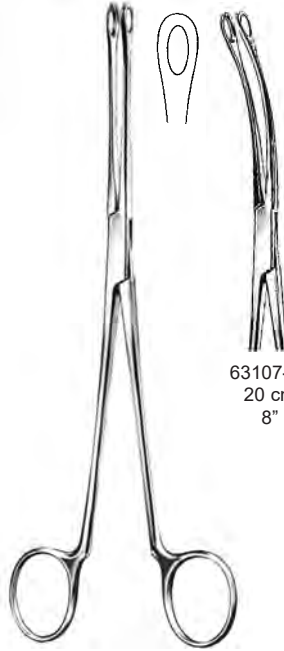


Fig. 1
 63101-23



Fig. 2
 63103-23



BLAKE
 63106-20 20 cm, 8"

63107-20
 20 cm
 8"



MAYO-BLAKE
 63110-20 20 cm, 8"



MAYO-BLAKE
 63111-20 20 cm, 8"

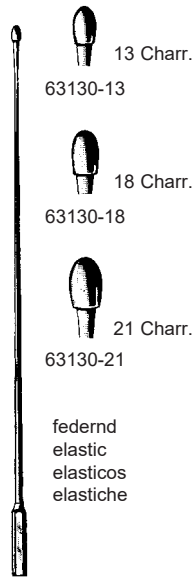


MIXTER
 63117-22 22 cm, 8 3/4"

Gallensteinsonden, Gallengangdilatoren
 Gall Stone Probes, Bile duct dilators
 Exploradores para cálculos biliares, Dilatadores para conductos biliares
 Sonde per calcoli biliari, Dilatatori per condotti biliari

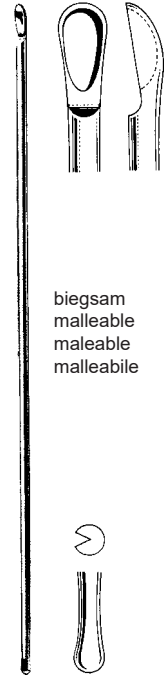


OCHSNER
 63128-35
 40 cm, 15 3/4"



DESJARDINS
 63130-13 - 63130-21
 28 cm, 11"

federnd
 elastic
 elasticos
 elastiche



MOYNIHAN
 63142-34 34 cm, 13 1/2"

biegsam
 malleable
 maleable
 malleabile

Gallensteinsonden, Gallengangdilatatoren

Gall Stone Probes, Bile duct dilators

Exploradores para cálculos biliares, Dilatadores para conductos biliares

Sonde per calcoli biliari, Dilatatori per condotti biliari

biegsam
malleable
maleable
malleabile



Ø mm 1
63150-01

2
-02

3
-03

4
-04

5
-05

6
-06

7
-07

Ø mm 8
63150-08

9
-09

10
-10

11
-11

12
-12

13
-13

63150-00 = Satz à 9 St. / set of 9 size 3 to 11
juego de 9 fig. 3-11 / serie di 9 pezzi

BAKES

63150-01 - 63150-13
30 cm, 11 3/4"

Gallensteinlöffel
 Gall Stone Scoops
 Cucharillas para cálculos biliares
 Cucchiari per calcoli biliari

biegsam
 malleable
 malleables
 malleabile



LUER-KOERTE
 63173-01 - 63173-08
 32 cm, 12 3/4"

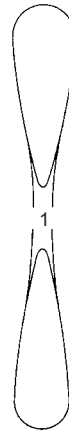


FERGUSSON
 63170-21 - 63170-23

8,5 mm

11,5 mm

12,5 mm



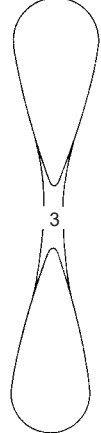
10,5 mm

63170-21
 24 cm
 9 1/2"



12,5 mm

63170-22
 24 cm
 9 1/2"



13,0 mm

63170-23
 24 cm
 9 1/2"



2,5 mm

Fig. 000
 63173-01



3,2 mm

Fig. 00
 63173-02



3,6 mm

Fig. 0
 63173-03



5,5 mm

Fig. 1
 63173-04



6,7 mm

Fig.2
 63173-05



8,0 mm

Fig. 3
 63173-06



11 mm

Fig. 4
 63173-07



15 mm

Fig. 5
 63173-08

Gallensteinlöffel, Gallengangsonde
 Gall Stone Scoops, Gall Duct Probes
 Cucharillas para cálculos biliares, sonda para conducto biliar
 Cucchiari per calcoli biliari, sonda per bile



17 Charr.

Fig. 1
63180-17



21 Charr.

Fig. 2
63180-21



24 Charr.

Fig. 3
63180-24



27 Charr.

Fig. 4
63180-27

federnd
 elastic
 elásticas
 elastiche

DESJARDINS
 63180-17 - 63180-27
 30 cm, 11 $\frac{3}{4}$ "



MAYO
 63175-27
 27 cm, 10 $\frac{1}{2}$ "



biegsam
 malleable
 malleable
 malleabile

MAYO
 63210-32
 32 cm, 12 $\frac{3}{4}$ "

Nierensteinzange
Kidney Stone Forceps
Pinzas para cálculos renales,
Pinze per calcoli renali

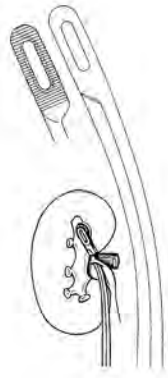


Fig. 1
63231-01 23 cm, 9"

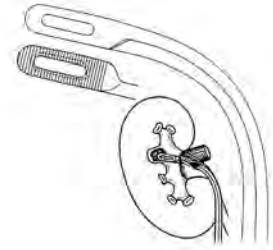


Fig. 2
63231-02 22 cm, 8 3/4"

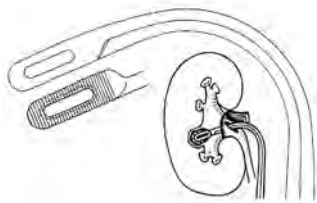


Fig. 3
63231-03 22 cm, 8 3/4"

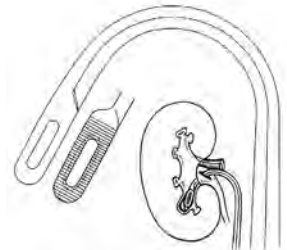


Fig. 4
63231-04 22 cm, 8 3/4"



Fig. 5
63231-05 19 cm, 7 1/2"

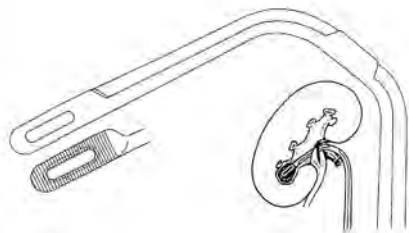


Fig. 6
63231-06 19 cm, 7 1/2"

RANDALL

Nierensteinzange
Kidney Stone Forceps
Pinzas para cálculos renales
Pinze per calcoli renali



HEIMING

für Kinder
for children
para niños
per bambini



63232-01
17 cm, 6 3/4"

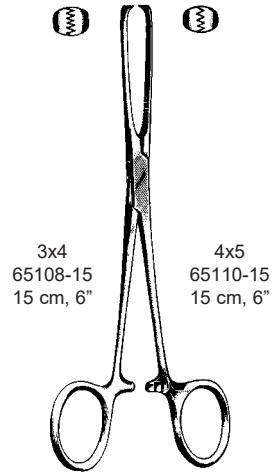


63232-02
16 cm, 6 1/4"

Darm- und Gewebefasszangen
 Intestinal and Tissue Grasping Forceps
 Pinzas para intestinos y tejidos
 Pinze per afferrare intestino e tessuti



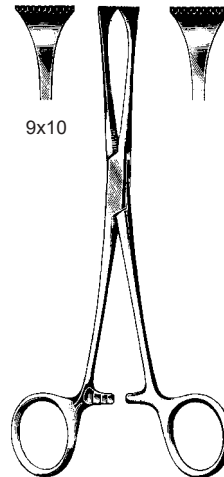
ALLIS-BABY
 65102-12 12 cm, 4 3/4"
 65102-14 14 cm, 5 1/2"



ALLIS 5x6
 65120-15 15 cm, 6"
 65120-19 19 cm, 7 1/2"
 65120-22 22 cm, 8 3/4"
 65120-24 24 cm, 9 1/2"
 65120-30 30 cm, 12"



ALLIS
 65124-16 16 cm, 6 1/4"
 65124-20 20 cm, 8"
 65124-22 22 cm, 8 3/4"
 65124-25 25 cm, 10"
 65124-30 30 cm, 11 3/4"

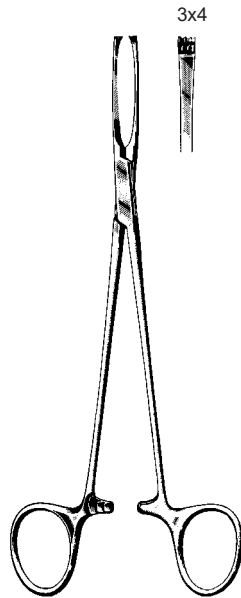


ALLIS-ADAIR
 65130-15
 15,5 cm, 6"

Darm- und Gewebefasszangen
 Intestinal and Tissue Grasping Forceps
 Pinzas para intestinos y tejidos
 Pinze per afferrare intestino e tessuti



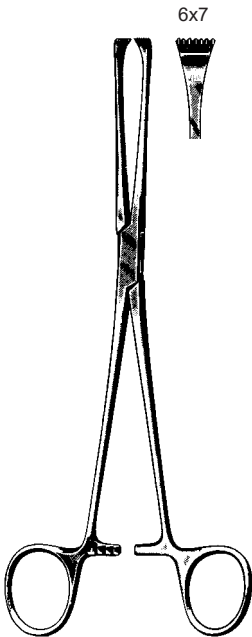
LOCKWOOD-ALLIS
 65132-16 16 cm, 6 1/4"
 65132-20 20 cm, 8"



JUDD-ALLIS
 65140-15 15 cm, 6"
 65140-19 19 cm, 7 1/2"



BOYS-ALLIS
 65145-15 15 cm, 6"



THOMS-ALLIS
 65150-20 20 cm, 8"



LITTLEWOOD
 65154-18 18,5 cm, 7 1/4"



GREGOIRE
 65155-18 18 cm, 7"
 65155-20 20 cm, 8"

Darm- und Gewebefassungen
 Intestinal and Tissue Grasping Forceps
 Pinzas para intestinos y tejidos
 Pinze per afferrare intestino e tessuti

Atrauma

10 mm

65168-16 16 cm, 6 1/4"
 65168-20 20 cm, 8"

BABCOCK

65160-14 14 cm, 5 1/2"
 65160-16 16 cm, 6 1/4" **65164-16 TC 16 cm**
 65160-18 18 cm, 7"
 65160-20 20 cm, 8" **65164-20 TC 20 cm**
 65160-24 24 cm, 9 1/2"

DUVAL

13 mm

25 mm

65170-18 18 cm, 7"
 65170-20 20 cm, 8" **65174-20 TC**
 20 cm, 8"
 23 cm, 9" 65172-23 65172-23

65170-18 - 65172-23

Atrauma

21 mm

23 mm

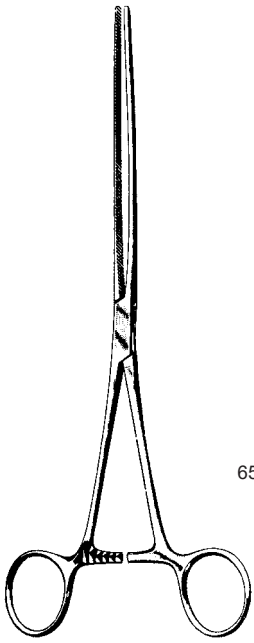
65178-19 19 cm 7 1/2"
 65178-23 23 cm 9"

COLLIN

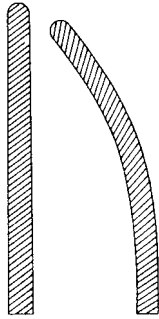
WILLIAMS

65180-16 16,5 cm, 6 1/2"

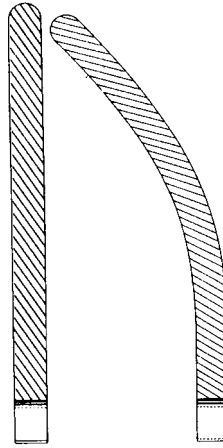
Darmklemmen
 Intestinal Forceps
 Pinzas intestinales
 Pinze intestinali



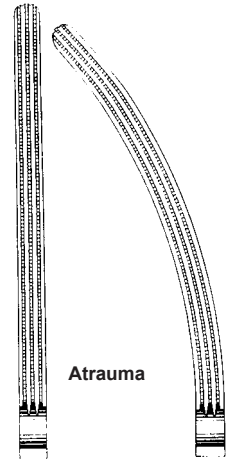
DOYEN
 65210-18 - 65217-23



DOYEN-BABY
 65210-18 18 cm, 7"
 65211-18



DOYEN
 65210-21 21 cm, 8 1/4"
 65210-23 23 cm, 9" 65211-21
 65211-23

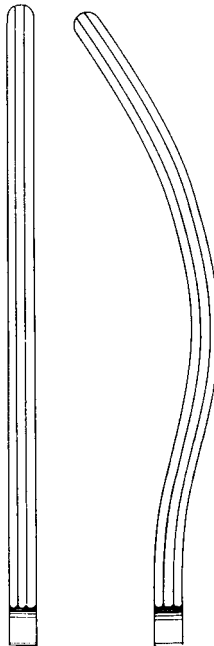


Atrauma

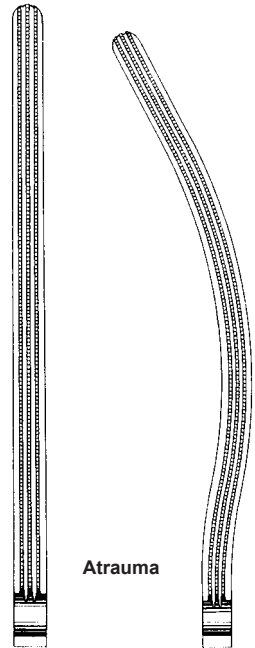
DOYEN
 65216-13 13 cm, 5 1/8" 65217-13
 65216-16 16 cm, 6 1/4" 65217-16
 65216-18 18 cm, 7" 65217-18
 65216-21 21 cm, 8 1/4" 65217-21
 65216-23 23 cm, 9" 65217-23



KOCHER
 65220-22 - 65227-28



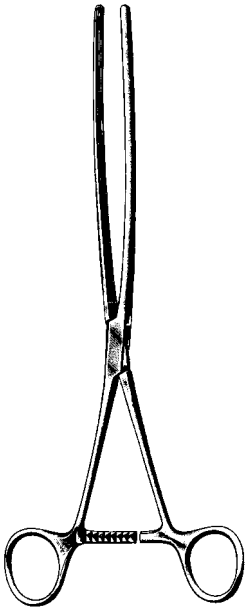
65220-13 13 cm, 5 1/8" 65221-13 BABY-KOCHER
 65220-22 22 cm, 8 3/4" 65221-22
 65220-25 25 cm, 10" 65221-25
 65220-28 28 cm, 11" 65221-28



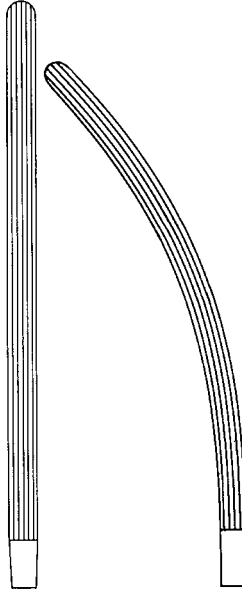
Atrauma

65226-22 22 cm, 8 3/4" 65227-22
 65226-25 25 cm, 10" 65227-25
 65226-28 28 cm, 11" 65227-28

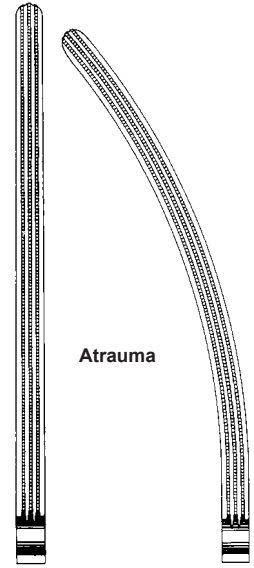
Darmklemmen
Intestinal Forceps
Pinzas intestinales
Pinze intestinali



MAYO-ROBSON
65230-21 21 cm, 8 1/4"
65237-25 25 cm, 10"



65230-21 21 cm, 8 1/4" 65231-21
65230-23 23 cm, 9" 65231-23
65230-25 25 cm, 10" 65231-25



Atrauma
65236-25 25 cm, 10" 65237-25



SCUDDER
65238-33
33 cm, 13"



Atrauma



65239-33
33 cm, 13"

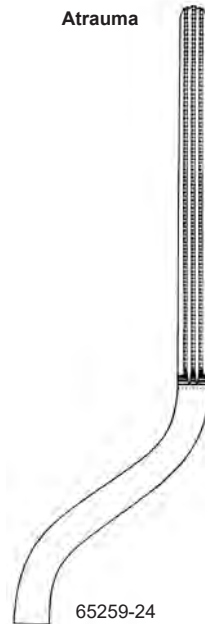
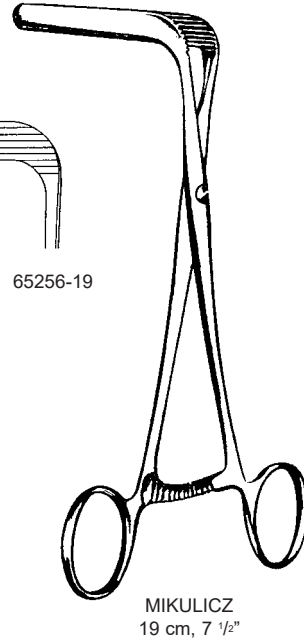
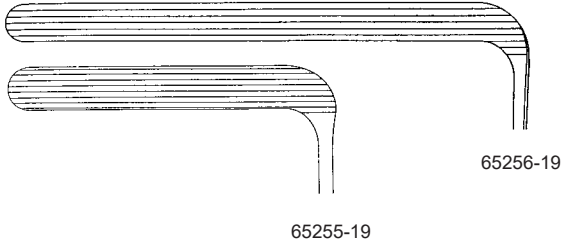
Darmklemmen
Intestinal Forceps
Pinzas intestinales
Pinze intestinali



FEHLAND
65241-23
23,5 cm 9 1/4"

RESANO
65242-30
30 cm, 11 3/4"

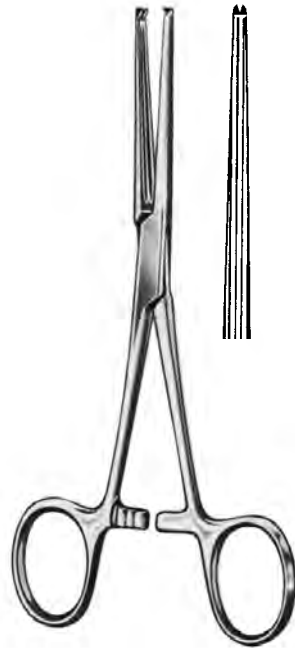
Magen-Darmklemmen
 Intestinal and Stomach Clamps
 Pinzas-clamps intestinales y estomacales
 Pinze intestinali e stomacali



Pylorusspreizer, Blinddarmklemmen
Pylorus spreader, Blindgut forceps
Separador para píloro, Pinzas para apéndice
Divaricatori per piloro, Pinza per appendice



BENSON
65261-15
15,5 cm, 6"

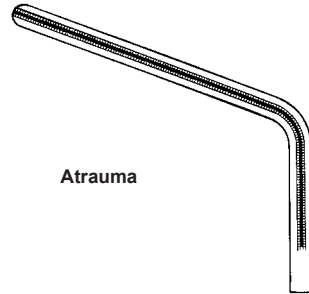


ALLEN
65263-15 15 cm, 6"
65263-20 20 cm, 8"

Darm-Anastomosenklemmen
 Intestinal Anastomosis Clamps
 Clamps para anastomosis intestinales
 Pinze per anastomosi intestinali

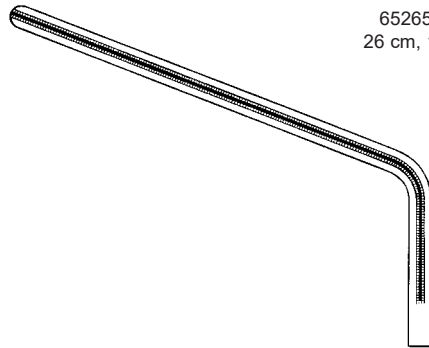


HAYES
 65265-26 26 cm, 10 1/4"
 65265-28 28 cm, 11"



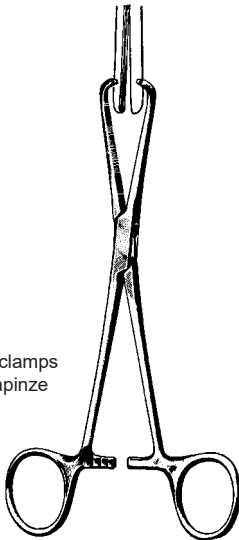
Atrauma

65265-26
 26 cm, 10 1/4"



65265-28
 28 cm, 11"

Schließklemme
 Closing Forceps
 Pinza para cerrar clamps
 Serrapinze e portapinze



STONE-WATT
 65270-15
 15,5 cm, 6"



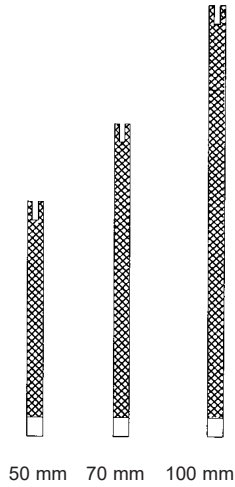
STONE-WATT
 65272-07 7,5 cm, 3"
 65272-10 10,0 cm, 4"

Klemmschloß
 Locking Device
 Cierre para clamps intestinales
 Serratura per pinze intestinali



STONE-WATT
 65274-00

Darm-Anastomosenklemmen
 Intestinal Anastomosis Clamps
 Clamps para anastomosis intestinales
 Pinze per anastomosi intestinali



DE MARTEL-WOLFSON
 65280-05 5 cm, 2" set of 3
 65280-07 7 cm, 2 3/4" set of 3
 65280-10 10 cm, 4" set of 3

Klemmschließzange
 Closing Forceps
 Pinza para cerrar grapas
 Serrapinze



DE MARTEL-WOLFSON
 65282-26 26 cm, 10 1/4"

Darm-Anastomosenklemmen
Intestinal Anastomosis Clamps
Clamps para anastomosis intestinales
Pinze per anastomosi intestinali

Klemmenhalterung
Clamp Holder
Porta-clamp
Portapinze



DE MARTEL-WOLFSON
65284-08 8,5 cm, 3 1/2"

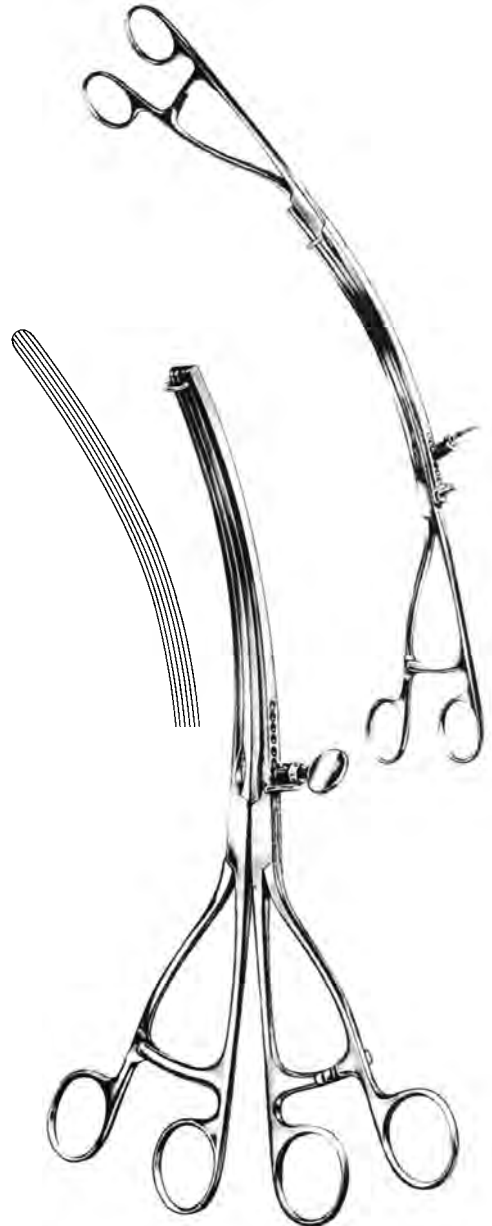


DE MARTEL-WOLFSON
65284-23 23 cm, 9"

Magen- und Darm-Zwillingsklemmen
 Stomach and Intestinal Anastomosis Twin Clamps
 Pinzas gastro-intestinales gemelas
 Pinze gastrointestinali gemelle

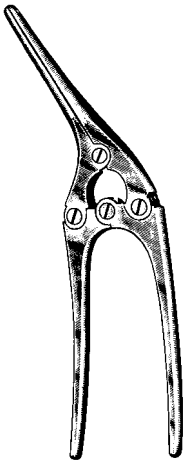


LANE
 65290-30 30 cm, 11 3/4"

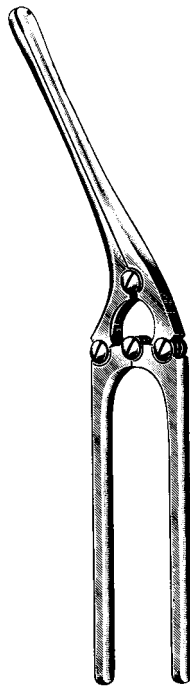


LANE
 65291-30 30 cm, 11 3/4"

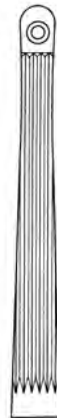
Darm- und Magenquetschklemmen
Intestinal and Stomach Clamps
Pinzas-clamps intestinales y estomacales
Pinze e Schiacciatori per l'intestino e lo stomaco



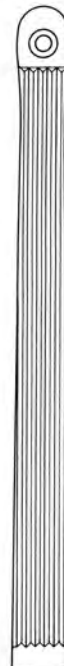
PAYR-BABY
65310-15
15 cm, 6"



PAYR



65310-21
21 cm, 8 1/4"



65310-29
29 cm, 11 1/2"



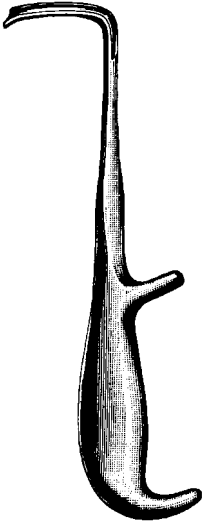
65310-35
35 cm, 14"

Prostatahaken, Prostatafaßzange, Kapsel­faßzange

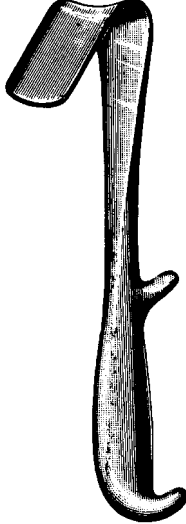
Prostatic retractors, Grasping forceps for the capsule – anterior lobe and ligature carrier

Separador para prostata, pinza de agarre para capsula y prostate

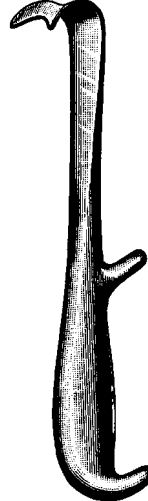
Divaricatori per prostata, pinza per afferrare la capsula e prostata



YOUNG
67101-21
21 cm, 8 1/4"



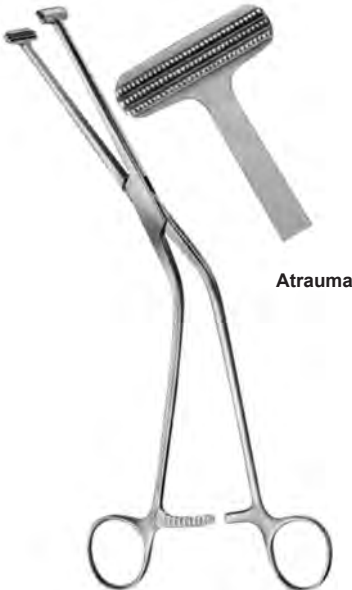
YOUNG
67103-22
22 cm, 8 3/4"



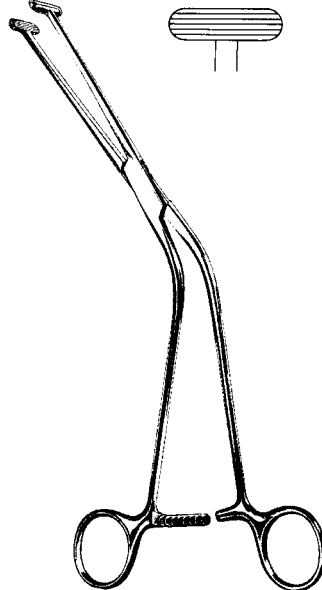
YOUNG
67105-21
21 cm, 8 1/4"



YOUNG
67105-22
22 cm, 8 3/4"

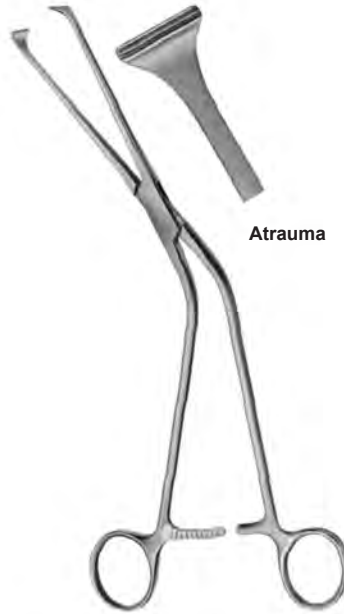


MILLIN
67110-23
23,5 cm, 9 1/4"



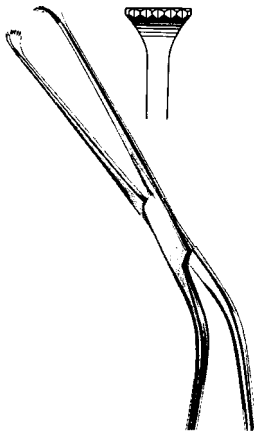
MILLIN
67111-23
23 cm, 9"

Kapselfasszange, Fadenführungszange
 Capsule Forceps, Ligature Carrying Forceps
 Pinzas capsulares, Pinza porta ligaduras
 Pinze per afferrare capsule, Pinza porta-filo

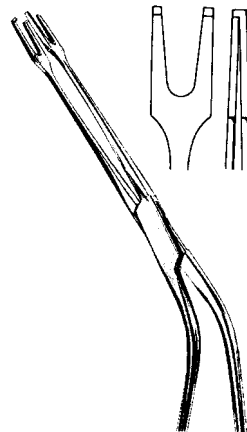


Atrauma

MILLIN
 67122-23
 24,5 cm, 9 3/4"



MILLIN
 67123-23
 23 cm, 9"



MILLIN
 67125-24
 24 cm, 9 1/2"

Blasenwundspreizer, Blasenspatel
 Bladder Retractors
 Separadores vesicales, Espátula vesical
 Divaricatori vescicali, Spatoli vescicali



MILLIN

67130-00 komplett, ohne Kaltlicht
 complete, without fiber optic
 completo, sin soporte de luz fría
 completo, senza fibre ottiche

67132-00 komplett, mit Kaltlicht
 complete, with fiber optic
 completo, con soporte de luz fría
 completo, con fibre ottiche

35 mm

67 mm

LEGUEU
67147-27KOCHER
67149-27

JUDD-MASSON

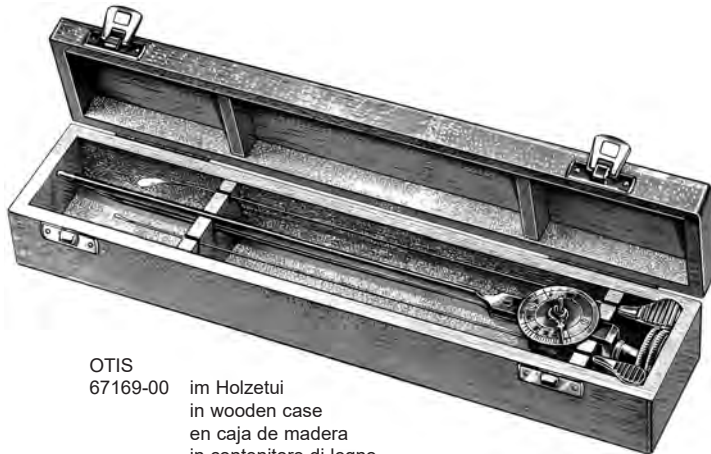
67150-00 mit Mittelvalve, with Central Blade
 con valva central, con valva centrale

THOMSON-WALKER
67160-00

Blasenwundspreizer, Urethrotome
 Bladder Retractors, Urethrotomes
 Separadores vesicales, Uretrótomos
 Divaricatori vescicali, Uretrotomi



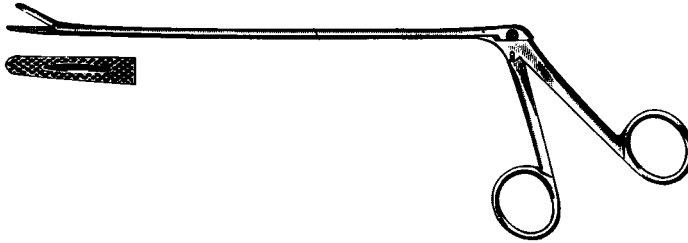
HRYNTSCHAK
 67170-00



OTIS
 67169-00 im Holzetui
 in wooden case
 en caja de madera
 in contenitore di legno

67169-01 Ersatzblatt alleine
 Blade only
 Hoja de repuesto
 Lame di ricambio

Fremdkörperzange, Penisklemmen
 Foreign Body Forceps, Penis Seizing Forceps
 Pinzas para cuerpos extraños, Compresores uretrales
 Pinze per corpi estranei, Serrapene



MATHIEU

67172-20 20 cm, 8"

67172-28 28 cm, 11"



STOCKMANN

67175-08

8 cm, 3 1/8"



STRAUSS

67177-11

11 cm, 4 3/8"

Vasektomie-Klemme
 Vasectomy Forceps
 Pinza para vasectomia
 Pinza per vasectomia



67178-12
 12 cm, 4 3/4"

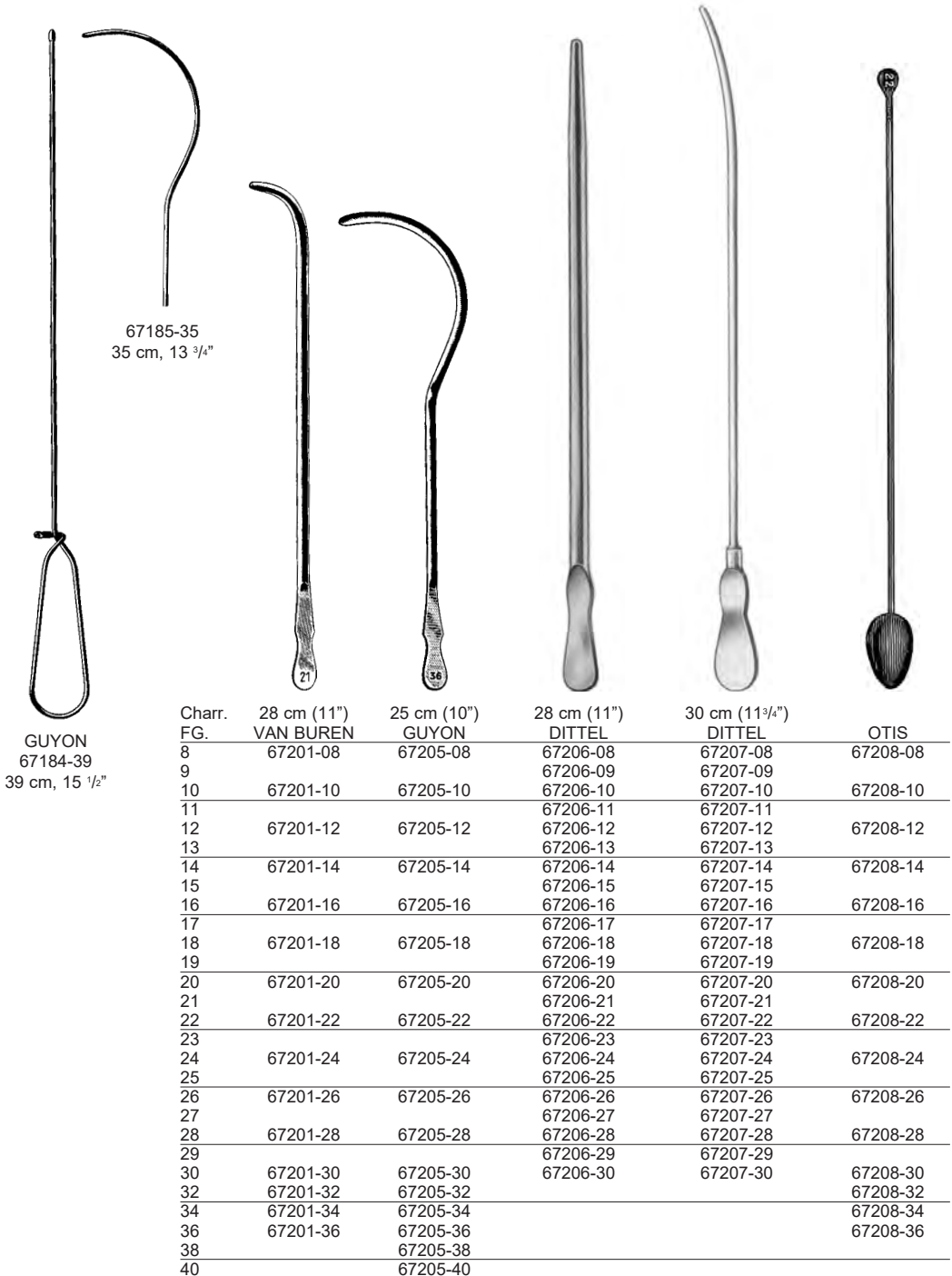


14 cm, 5 1/2"
 67178-14 Ø 3 mm
 67178-15 Ø 4 mm
 67178-16 Ø 5 mm

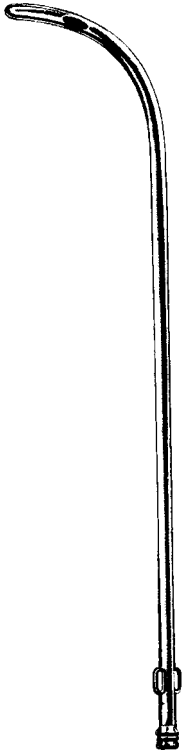


67179-14
 14,5 cm, 5 3/4"

Kathetereinführungsinstrumente, Dilatationsbougies
 Catheter Introducer, Dilating Bougies
 Introducitor de catéteres, Bujías dilatadoras
 Mandrini per sonda uretrali, Candelette dilatatrici



Metallkatheter
Metal Catheters
Sondas metálicas
Sonde metalliche



29 cm, 11 1/2"



15 cm, 6"



COXETER

Charr.
FG

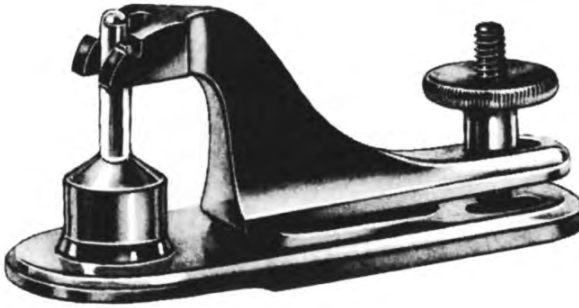
6		67213-06	
8	67211-08	67213-08	67219-08
10	67211-10	67213-10	67219-10
12	67211-12	67213-12	67219-12
14	67211-14	67213-14	67219-14
16	67211-16	67213-16	67219-16
18	67211-18	67213-18	67219-18
20	67211-20	67213-20	67219-20
22		67213-22	67219-22
24		67213-24	67219-24



WALTHER
13,5 cm, 5 1/4"
67220-00 (Set)

67220-12	12 Fr.
67220-14	14 Fr.
67220-16	16 Fr.
67220-18	18 Fr.
67220-20	20 Fr.
67220-22	22 Fr.
67220-24	24 Fr.
67220-26	26 Fr.
67220-28	28 Fr.
67220-30	30 Fr.
67220-32	32 Fr.
67220-34	34 Fr.
67220-36	36 Fr.
67220-38	38 Fr.

Beschneidungsinstrument
Circumcision Instrument
Instrumentos para circuncisión
Strumenti per circoncisione



67240-08	8 mm Ø
67240-11	11 mm Ø
67240-13	13 mm Ø
67240-16	16 mm Ø
67240-21	21 mm Ø
67240-26	26 mm Ø
67240-32	32 mm Ø

67240-08 - 67240-32



MOGEN

67250-07	7,5 cm (3")	2,5 mm
67251-07	7,5 cm (3")	1,5 mm
		für Kinder
		for children
		para niños
		per bambini

Mastdarm-Spekula
Rectal Specula
Especulos rectales
Specoli rettali



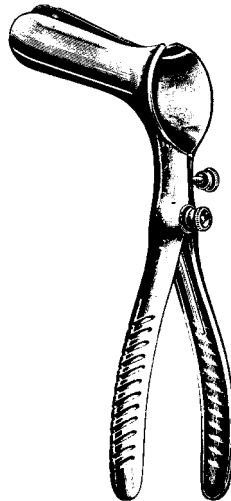
CZERNY
69105-22
22 cm, 8 3/4"



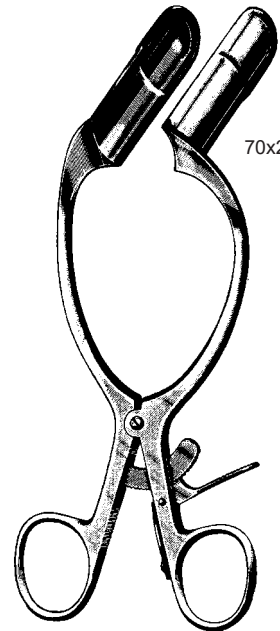
SIMS
69110-15
15 cm, 6"



BODENHAMMER
69115-15
15 cm, 6"



PRATT
69121-00
19 cm, 7 1/2"



BARR
69125-17
17 cm, 6 3/4"

70x22 mm

Mastdarm-Spekula
Rectal Specula
Espéculos rectales
Specoli rettali



HILL-FERGUSON, 20 cm, 8"
69126-01 6,4x2,2 cm 2 1/2" x 7/8"
69126-02 7,6x3,0 cm 3" x 1 3/16"
69126-03 7,6x3,6 cm 3" x 1 7/16"



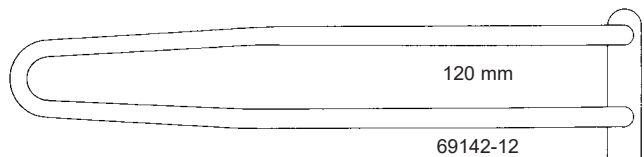
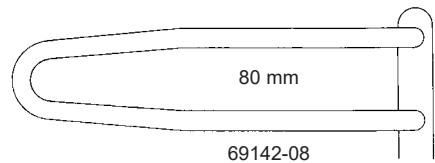
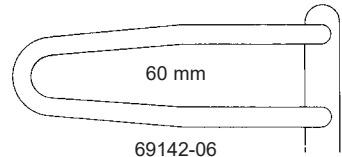
SAWYER, 25 cm, 9 3/4"
69127-01 6,4x2,2 cm 2 1/2" x 7/8"
69127-02 7,6x2,9 cm 3" x 1 1/8"
69127-03 8,9x3,8 cm 3 1/2" x 1 1/2"



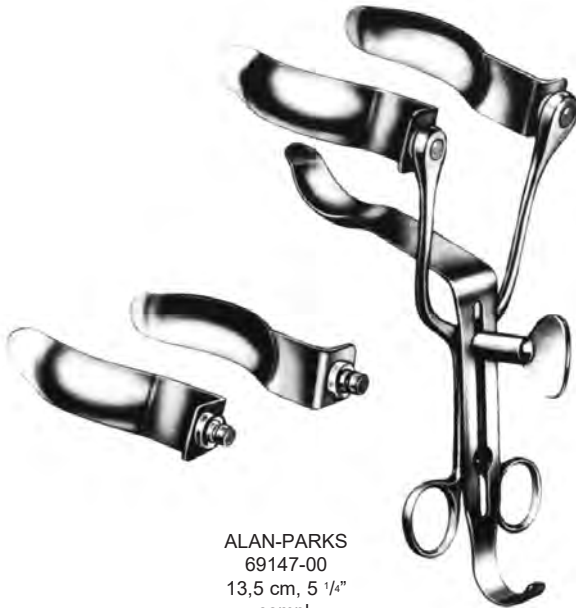
MATHIEU
69130-19
19,5 cm, 7 3/4"



SCHULZE-BERGMANN
69142-06 - 69142-12

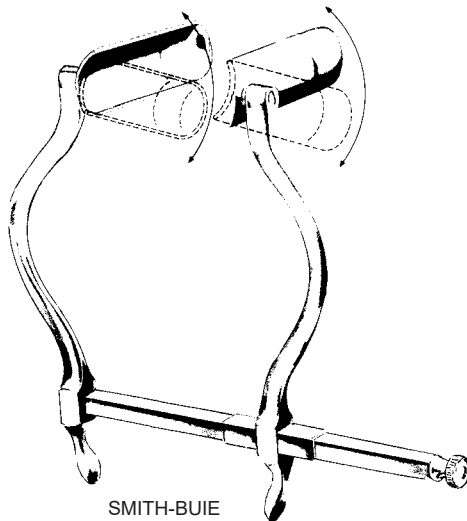


Anal spreizer
Anal Retractors
Separadores rectales
Dilatatori per l'ano e il retto



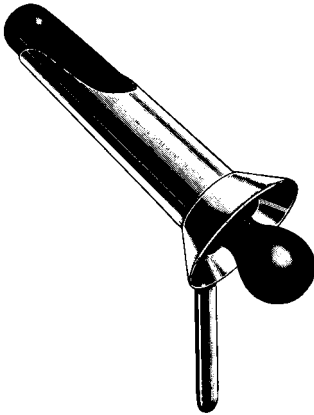
ALAN-PARKS
69147-00
13,5 cm, 5 1/4"
compl.

69148-00
Kaltlicht Zubehör für 69147-00
Cold Light Attachment for 69147-00
Adaptador para luz fría 69147-00
Adattatore luce fredda per 69147-00



SMITH-BUIE
69150-15
15 cm, 6"
75x23 mm

Anuskope, Proktoskope
 Anoscopes, Proctoscopes
 Anoscopios, Proctoscopios
 Anoscopi, Proctoscopi



IVES-FANSLER
 69210-22 22 mm Ø
 L = 80 mm



Ø mm HIRSCHMANN
 16 69212-16
 19 69212-19
 22 69212-22
 L = 65 mm

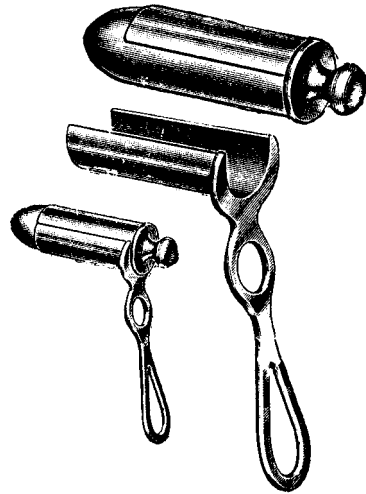


mm
 ØxL KELLY
 22x 50 69220-05
 22x100 69220-10
 22x140 69220-14
 22x200 69220-20

Sphinkteroskope, Proktoskope, Fistelsonde
 Sphincteroscopes, Proctoscopes, Fistula Probe
 Esfinteroscopios, Proctoscopios, Sondas para fistulas
 Sfinteroscopi, Protoscopi, Sonde per fistole



Ø mm KELLY
 21 69224-21
 27 69224-27
 L = 50 mm, 2"



Ø mm CHELSEA-EATON
 22 x 65 69225-22
 30 x 65 69225-30



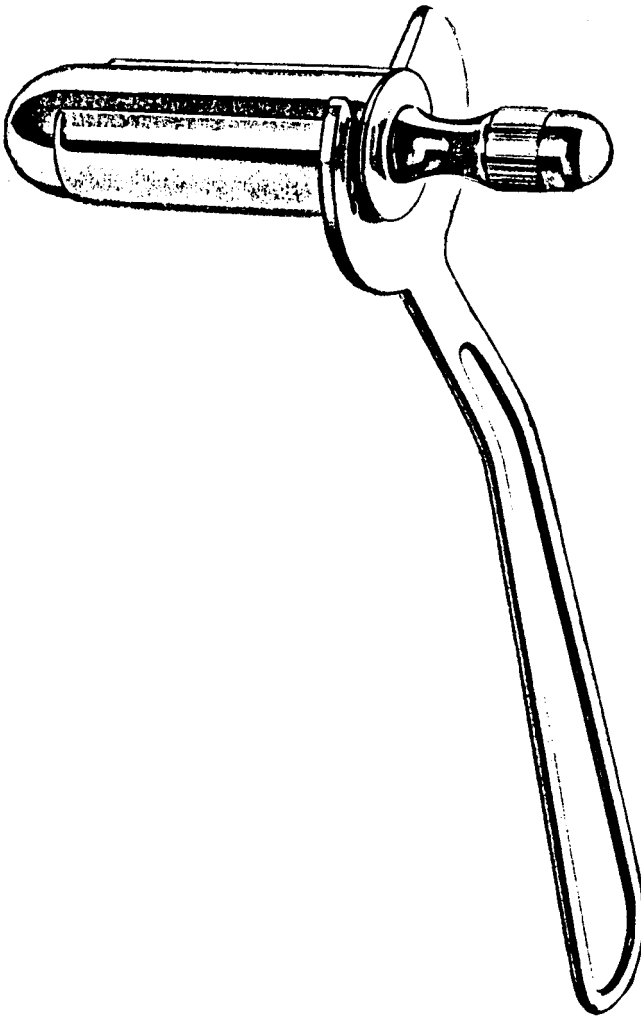
Fig. 1
 69251-01

Fig. 2
 69251-02

Fig. 3
 69251-03

PRATT
 21 cm, 8 1/4"
 69251-01 - 69251-03

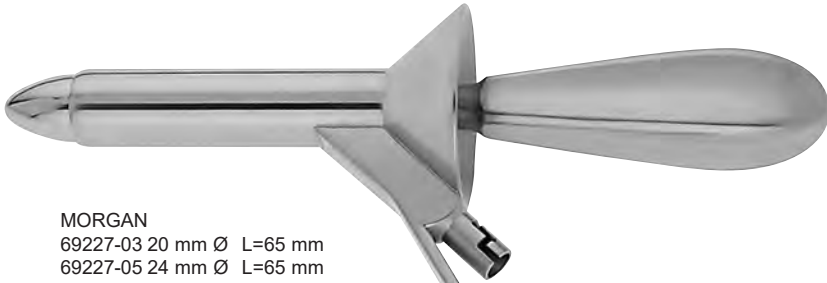
Proktoskope
Proctoscopes
Proctoscopios
Protoscopi



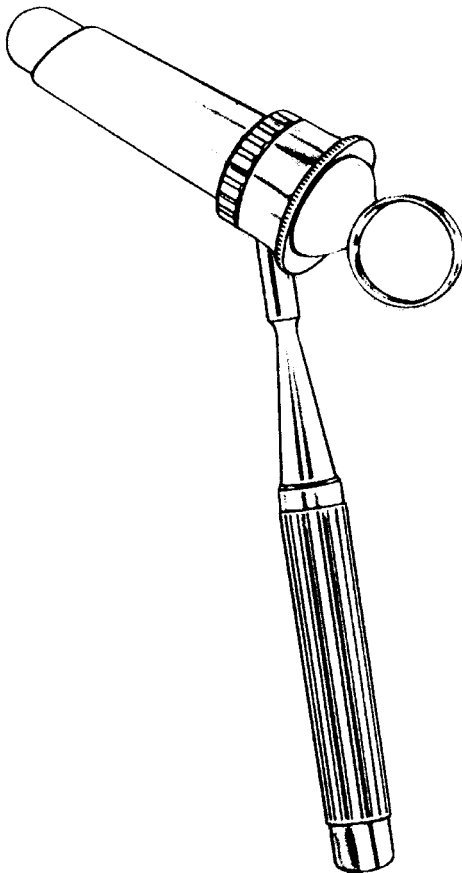
FANSLER
24 cm, 9 1/2"

Ø	L	
25 x 65 mm	69226-25	
29 x 65 mm	69226-29	
38 x 70 mm	69226-38	

Proktoskope
Proctoscopes
Proctoscopios
Protoscopi



MORGAN
69227-03 20 mm Ø L=65 mm
69227-05 24 mm Ø L=65 mm



BENSAUDE
69229-01 19 mm Ø L=70 mm
69229-02 22 mm Ø L=70 mm

Mastdarmbiopsiezangen
 Rectal Biopsy Specimen Forceps
 Pinzas para biopsia rectal
 Pinze taglienti per biopsia rettale

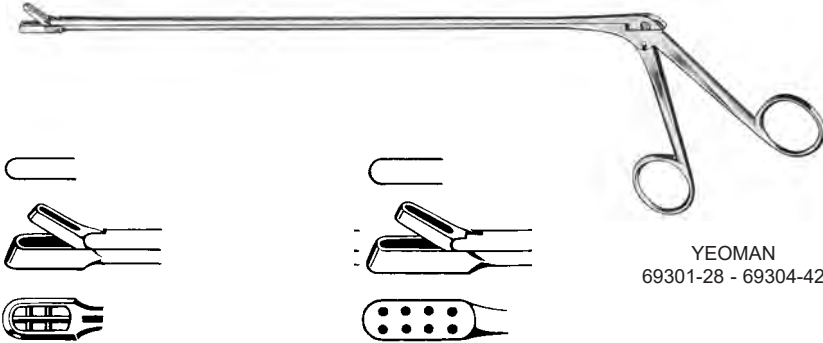


Fig. 1

69301-28 28 cm, 11"
 69301-35 35 cm, 13 3/4"
 69301-42 42 cm, 16 1/2"

Fig. 2

69302-28 28 cm, 11"
 69302-35 35 cm, 13 3/4"
 69302-42 42 cm, 16 1/2"



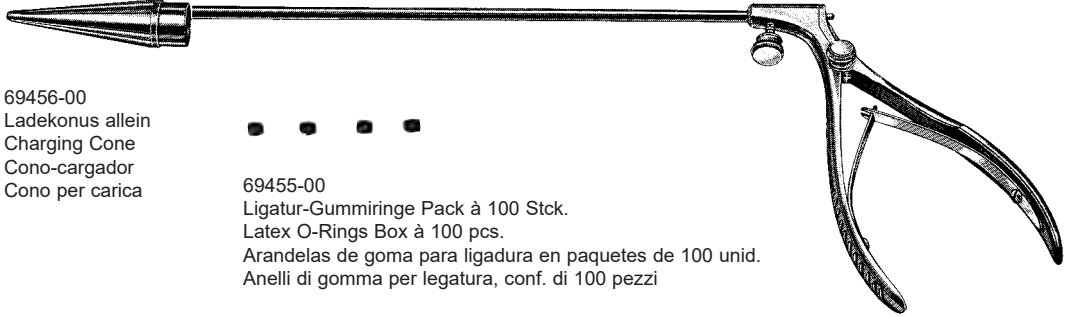
BUIE
 69261-41
 41 cm, 16"

Hämorrhoidalzange
Haemorrhoidal Forceps
Pinzas-clamps hemorroidales
Pinze per emorroidi



HEYWOOD-SMITH
69402-21 21 cm, 8 1/4"
69402-25 25 cm, 10"

Hämorrhoidal-Ligatoren, Hämorrhoidal-Fasszange
 Haemorrhoidal Ligators, Haemorrhoidal Forceps
 Ligadores para hemorroides, Pinzas-clamps para hemorroides
 Legatori emorroidali, Pinze per emorroidi

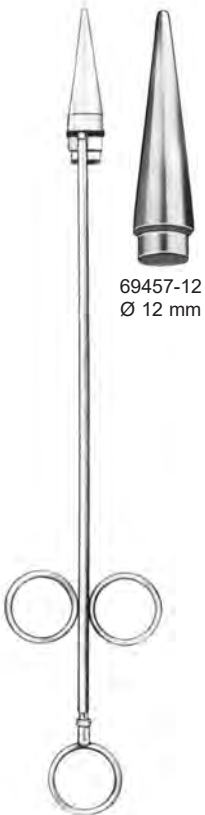


69456-00
 Ladekonus allein
 Charging Cone
 Cono-cargador
 Cono per carica



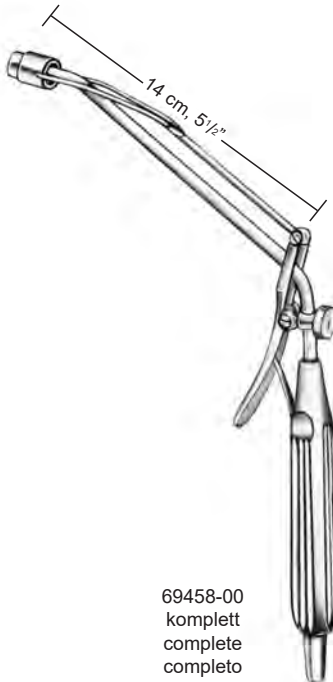
69455-00
 Ligatur-Gummiringe Pack à 100 Stck.
 Latex O-Rings Box à 100 pcs.
 Arandelas de goma para ligadura en paquetes de 100 unid.
 Anelli di gomma per legatura, conf. di 100 pezzi

MC GIVNEY
 69450-18
 18 cm, 7"



69457-12
 Ø 12 mm

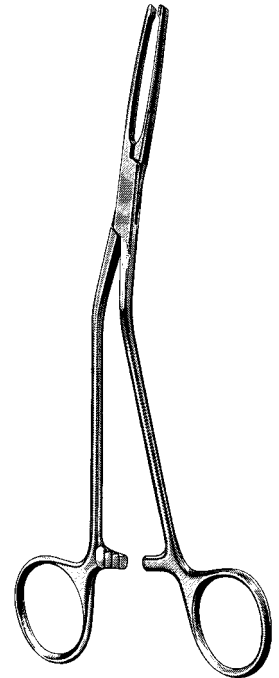
RUDD
 69457-31
 31,5 cm, 12 1/2"
 kplt./cplt.



69458-00
 komplett
 complete
 completo



Ø 10 mm
 69458-10
 Ladekonus
 Charging cone
 Cono-cargador
 Cono per carica



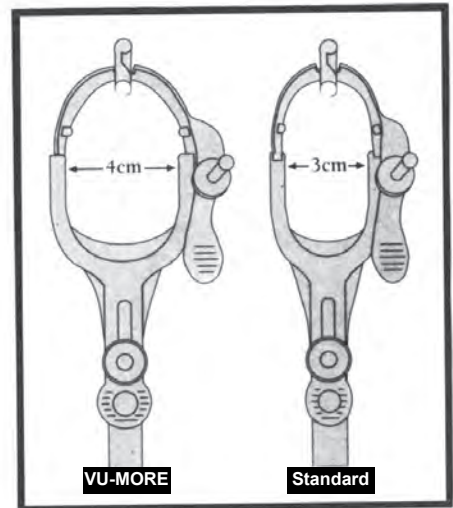
MC GIVNEY
 69460-00
 19 cm, 7 1/2"

Lateral-Scheidenspekula
 Lateral Vaginal Retractor
 Espéculos vaginales
 Specoli vaginali



71100-00

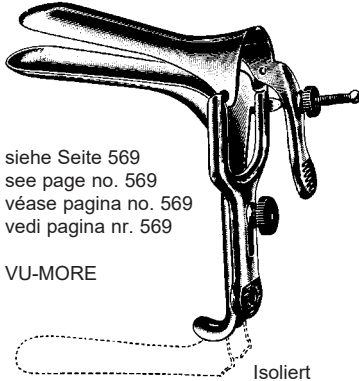
Lateralspreizer allein
 Vaginal retractor lateral only
 Espéculo vaginal solo
 Specolo vaginale laterale, solo



VU-MORE

Fig.	mm	
2	95x35	71115-02
3	115x35	71115-03

Scheidenspekula
Vaginal Specula
Espéculos vaginales
Specoli vaginali

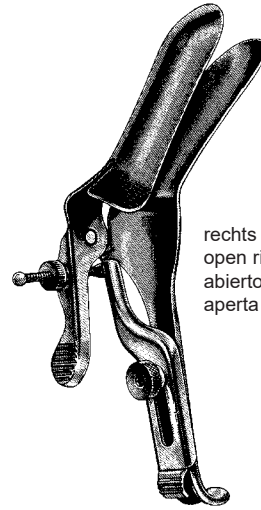


siehe Seite 569
see page no. 569
véase pagina no. 569
vedi pagina nr. 569

VU-MORE

GRAVE

Fig.	mm	Standard	Isoliert Insulated Aislado Isolato
1	75x20	71110-01	71110-01 INS
2	95x35	71110-02	71110-02 INS
3	115x35	71110-03	71110-03 INS



rechts offen
open right-side
abierto a la derecha
aperta a destra

GRAVE
71116-02

mittel, medium, mediano, medio
101x35 mm

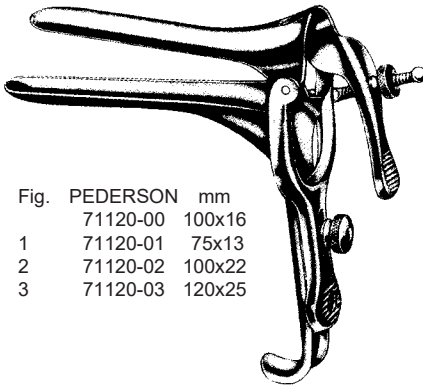


Fig.	PEDERSON	mm
	71120-00	100x16
1	71120-01	75x13
2	71120-02	100x22
3	71120-03	120x25

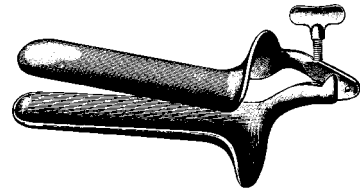
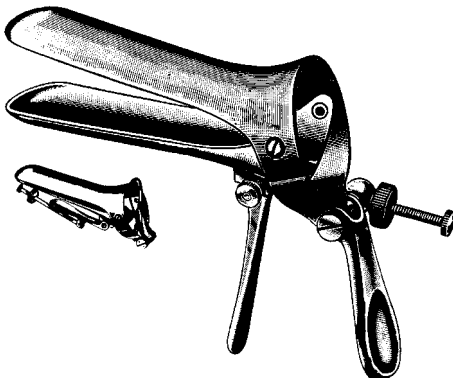


Fig.	COLLIN	mm
1	71130-01	85x30
2	71130-02	100x35
3	71130-03	110x40

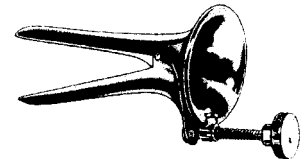


Seitliche Schraube
Lateral Screw
Tornillo lateral
Vite laterale

CUSCO

Fig.	mm	Standard
1	75x32	71140-01
2	85x35	71140-02
3	100x35	71140-03
4	75x17	71142-04

für Jungfrauen
for virgin
para vírgenes
per vergini



COLLIN
71132-00
65x10 mm

Scheidenspekula
 Vaginal Specula
 Espéculos vaginales
 Specoli vaginali

Mittelschraube
 Central Screw
 Tornillo central
 Vite centrale

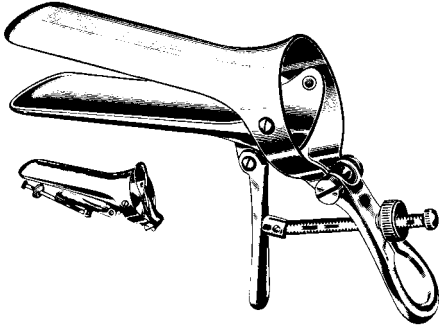


Fig.	CUSCO	mm
1	71150-01	75x32
2	71150-02	85x35
3	71150-03	100x37

Schweizer Modell
 Swiss Pattern
 Modelo suizo
 Modello svizzero

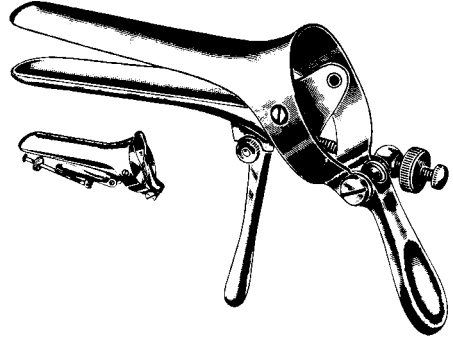


Fig.	CUSCO	mm
1	71160-01	90x23-25
2	71160-02	100x25-27
3	71160-03	110x27-30



SEMM	mm
71161-17	100 x 17 - 20 mm
71161-25	100 x 25 - 30 mm

Scheidenspekula
Vaginal Specula
Espéculos vaginales
Specoli vaginali

Satz bestehend aus je 1 Spekula und 1 Halter
Set consisting of 1 specula and 1 retractor
Juego de 1 espéculo y 1 valva
Serie da 1 specolo e 1 valva

Spekula
Speculum
Espéculo
Specolo

Halter
Retractor
Valva
Valve



Fig. KRISTELLER
1 71210-01
2 71210-02
3 71210-03

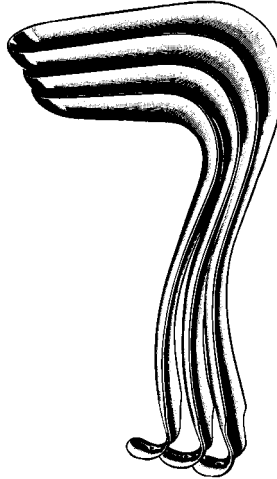


Fig. KRISTELLER mm
1 71211-01 70x27
2 71211-02 80x30
3 71211-03 90x36



Fig. KRISTELLER mm
1 71212-01 75x23
2 71212-02 85x26
3 71212-03 100x32



Fig. KRISTELLER
00 71240-00
0 71240-10
1 71240-01
2 71240-02
3 71240-03

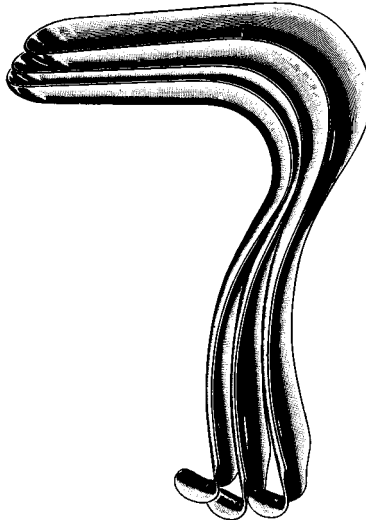


Fig. KRISTELLER mm
00 71241-00 110x18
0 71241-10 110x21
1 71241-01 110x27
2 71241-02 110x30
3 71241-03 110x36

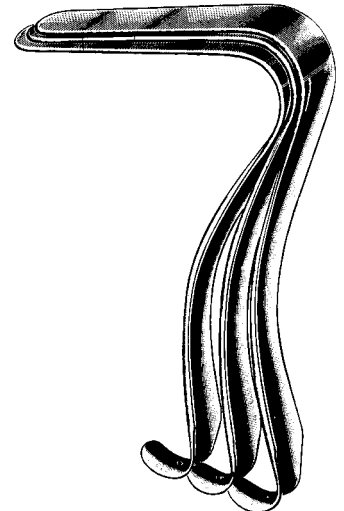
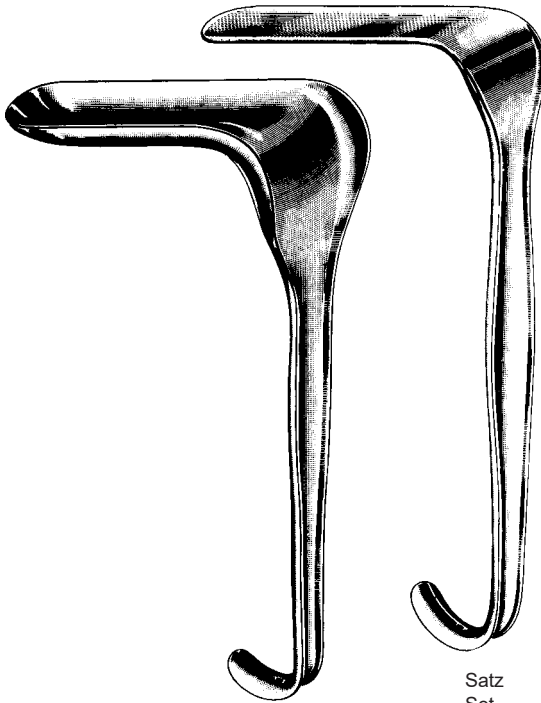


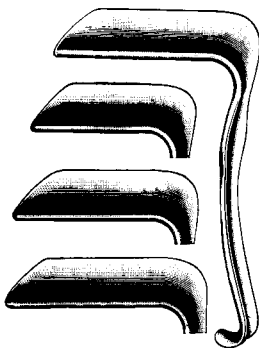
Fig. KRISTELLER mm
00 71242-00 115x14
0 71242-10 115x17
1 71242-01 115x23
2 71242-02 115x26
3 71242-03 115x32

Scheidenspekula
Vaginal Specula
Espéculos vaginales
Specoli vaginali



KALLMORGEN
71260-01 - 71262-02

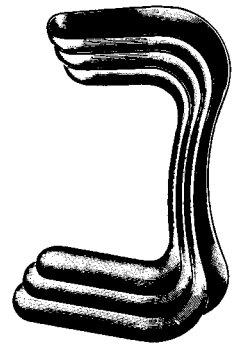
Fig.	Satz Set Juego Serie	Spekula Speculum Espéculo Specolo	mm	Halter Retractor Valva Valve	mm
1	71260-01	71261-01	70x40	71262-01	70x33
2	71260-02	71261-02	90x40	71262-02	90x33



JACKSON
Fig. mm
1 71271-01 75x38
2 71271-02 90x38
3 71271-03 100x38

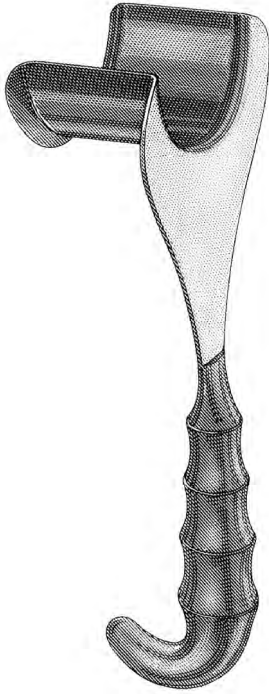


SIMS
Fig. mm
1 71281-01 63x32
2 71281-02 76x32
3 71281-03 89x38



SIMS
Fig. mm
1 71291-01 60x25+30
2 71291-02 70x30+35
3 71291-03 80x35+40
Set 71291-00 (Fig. 1,2,3)

Scheidenspekula
Vaginal Specula
Espéculos vaginales
Specoli vaginali



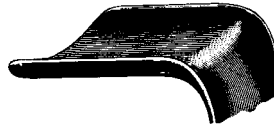
DELEE
71300-01
23,5 cm, 9 1/4"

leicht hohl
slightly concave
ligeramente concavos
leggermente concavi

Fig.		mm
1	71301-01	55x35
2	71301-02	85x35
3	71301-03	115x35

Fig.		mm
1	71303-01	55x45
2	71303-02	85x45
3	71303-03	115x45
4	71303-04	160x45
5	71303-05	180x45

Fig.		mm
1	71305-01	55x60
2	71305-02	85x60
3	71305-03	115x60
4	71305-04	160x60
5	71305-05	180x60



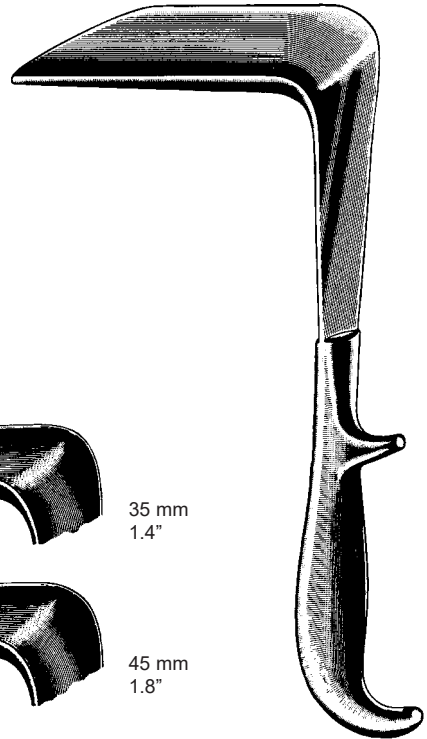
35 mm
1.4"



45 mm
1.8"



60 mm
2.4"



DOYEN
24 cm, 9 1/2"

Scheidenspekula
Vaginal Specula
Espéculos vaginales
Specoli vaginali

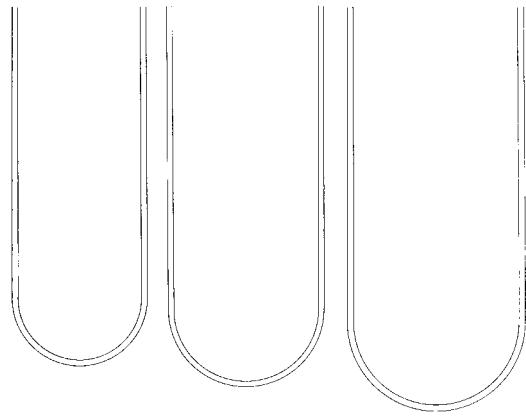
71306-01
80 x 30 mm

71306-02
85 x 35 mm

71306-03
90 x 40 mm

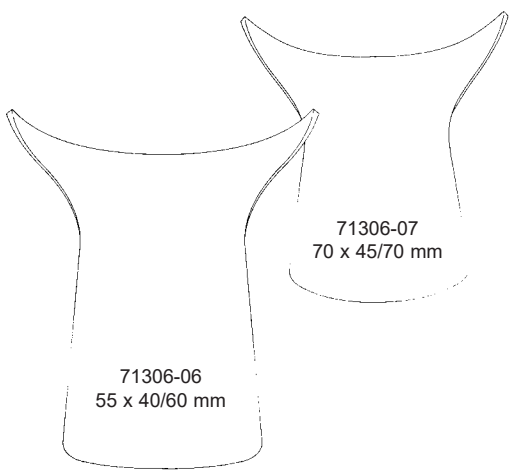


71306-01 - 71306-03



71306-04
Gewicht 400 gr
weight 400 grs
peso 400 grs
peso 400 grs

71306-05
Gewicht 800 grs
weight 800 grs
peso 800 grs
peso 800 grs



71306-06
55 x 40/60 mm

71306-07
70 x 45/70 mm

SCHERBAK
71306-00
Set komplett
complete set
juego completo
set completo



71306-08
Griff, handle,
mango, manico

Scheidenspekula
Vaginal Specula
Espéculos vaginales
Specoli vaginali



O'SULLIVAN-O'CONNOR
71308-00

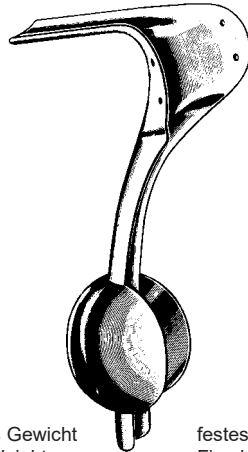
71308-00

komplett bestehend aus:
1 Rahmen mit 2 beweglichen Seitenvälven
3 austauschbare Mittelvälven Fig. 1-3

1 frame with 2 mobile lateral blades
3 interchangeable blades Fig. 1-3

1 Marco con 2 separadores móviles laterales
3 separadores centrales intercambiables fig. 1-3

1 telaio regolabile con 2 valve laterali mobili
3 valve intercambiabili fig. 1-3



abnehmbares Gewicht
Detachable Weight
Peso desmontable
Peso smontabile

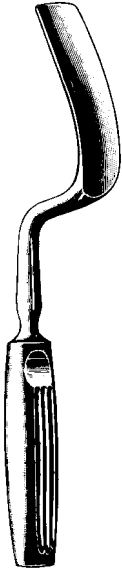
71307-00
1,4 kg
75 x 38 mm

AUVARD
24 cm, 9½"

festes Gewicht
Fixed Weight
Peso fijo
Peso fisso

71309-00
1,4 kg
105 x 38 mm

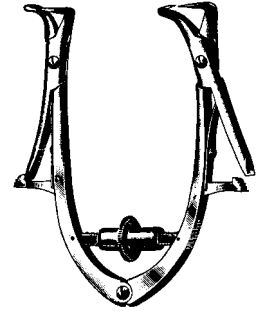
Scheidenspekula, Endospekula
Vaginal Specula, Endospekula
Espécúlos vaginales, Endo-espécúlos
Specoli vaginali, Endospecoli



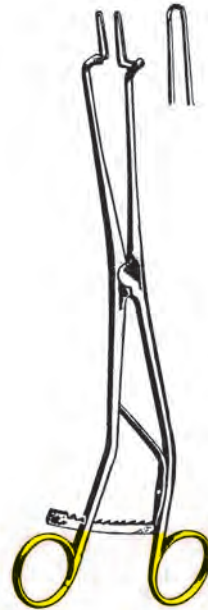
mm	BREISKY	
100x20	71310-20	28 cm, 11"
100x25	71310-25	28 cm, 11"
100x30	71310-30	28 cm, 11"
100x35	71310-35	28 cm, 11"
100x40	71310-40	28 cm, 11"
130x20	71313-20	33 cm, 13"
130x25	71313-25	33 cm, 13"
130x30	71313-30	33 cm, 13"
130x35	71313-35	33 cm, 13"
130x40	71313-40	33 cm, 13"
155x40	71315-40	35 cm, 13 $\frac{3}{4}$ "



mm	LANDAU	
100x28	71319-28	29 cm, 11 $\frac{1}{2}$ "
100x38	71319-38	29 cm, 11 $\frac{1}{2}$ "



	JOLL (FRIEDMANN)	
71351-10	10 cm, 4"	
71351-15	15 cm, 6"	

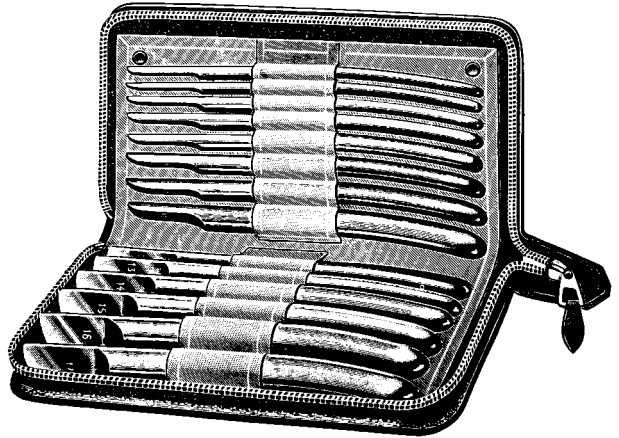


	KOGAN	
71360-24	3 mm	24 cm, 9 $\frac{1}{2}$ "
71361-24	4 mm	24 cm, 9 $\frac{1}{2}$ "
71362-24	5 mm	24 cm, 9 $\frac{1}{2}$ "



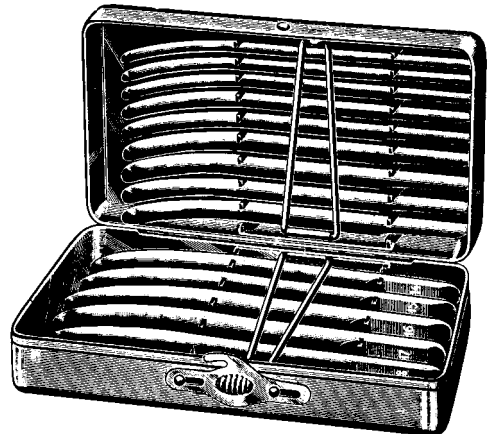
	KOGAN	
71363-24	3 mm	24 cm, 9 $\frac{1}{2}$ "
71364-24	4 mm	24 cm, 9 $\frac{1}{2}$ "
71365-24	5 mm	24 cm, 9 $\frac{1}{2}$ "

Uterus Dilatatore
 Uterine Dilators
 Diladores uterinos
 Dilattori uterini



mm Ø	HEGAR		mm Ø
1	71410-01	71415-01	1,5
2	71410-02	71415-02	2,5
3	71410-03	71415-03	3,5
4	71410-04	71415-04	4,5
5	71410-05	71415-05	5,5
6	71410-06	71415-06	6,5
7	71410-07	71415-07	7,5
8	71410-08	71415-08	8,5
9	71410-09	71415-09	9,5
10	71410-10	71415-10	10,5
11	71410-11	71415-11	11,5
12	71410-12	71415-12	12,5
13	71410-13	71415-13	13,5
14	71410-14	71415-14	14,5
15	71410-15	71415-15	15,5
16	71410-16	71415-16	16,5
17	71410-17	71415-17	17,5
18	71410-18	71415-18	18,5
19	71410-19	71415-19	19,5
20	71410-20		
21	71410-21		
22	71410-22		
23	71410-23		
24	71410-24		
25	71410-25		
26	71410-26		
27	71410-27		
28	71410-28		
29	71410-29		
30	71410-30		

HEGAR
 71405-14 4-17 mm
 14 St./pces./pzas./pezzi



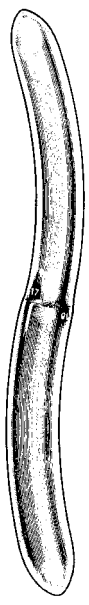
mm HEGAR
 4-17 71406-14 14 St./pces./pzas./pezzi
 1-26 71406-26 26 St./pces./pzas./pezzi

71404-14 Satz/Set/Juego/Set
 71410-04 - 71410-17 = 14

71404-26 Satz/Set/Juego/Set
 71410-01 - 71410-26 = 26

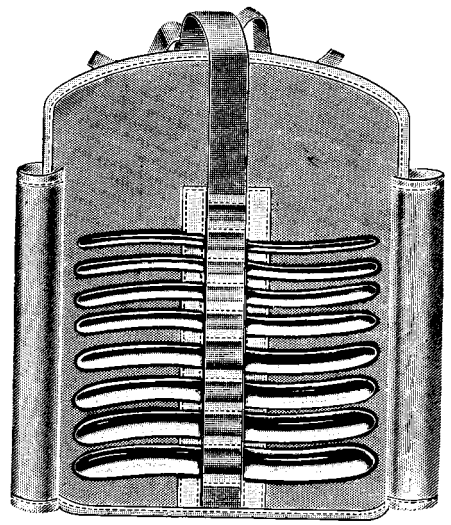
in Metalletui, in metal case,
 en estuche de metal, in astuccio metallico

Uterus Dilatatore
 Uterine Dilators
 Dilatadores uterinos
 Dilatatori uterini

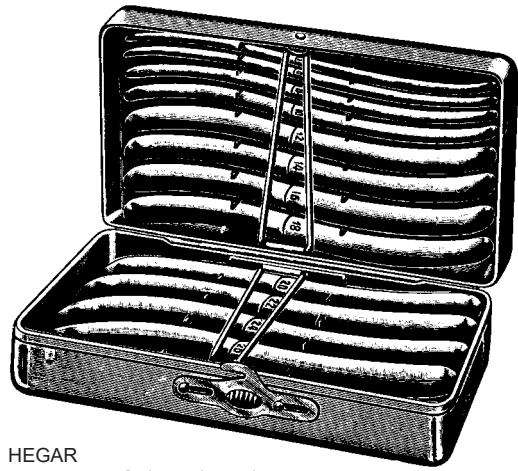


mm	HEGAR
1/2	71420-01
3/4	71420-03
5/6	71420-05
7/8	71420-07
9/10	71420-09
11/12	71420-11
13/14	71420-13
15/16	71420-15
17/18	71420-17
19/20	71420-19
21/22	71420-21
23/24	71420-23
25/26	71420-25

- 71424-08 Satz/Set/Juego/Set
 71420-03 - 71420-17 = 8
 3/4 - 17/18 mm
- 71424-13 Satz/Set/Juego/Set
 71420-01 - 71420-25 = 13
 1/2 - 25/26 mm

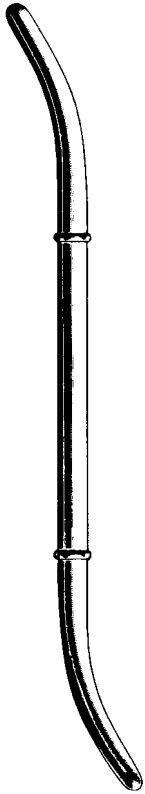


mm HEGAR
 3/4 - 17/18 71425-08 8 St./pces./pzas./pezzi
 in Stofftasche, in khaki roll,
 en bolsa de tela, in borsa di tela



mm HEGAR
 3/4 - 17/18 71426-08 8 St./pces./pzas./pezzi
 1/2 - 25/26 71426-13 13 St./pces./pzas./pezzi
 in Metalletui, in metal case,
 en estuche de metal, in astuccio metallico

Uterus Dilatatore
 Uterine Dilators
 Diladores uterinos
 Dilattatori uterini



in Stofftasche
 in khaki roll
 en bolsa de tela
 in borsa di tela

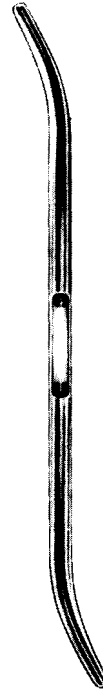
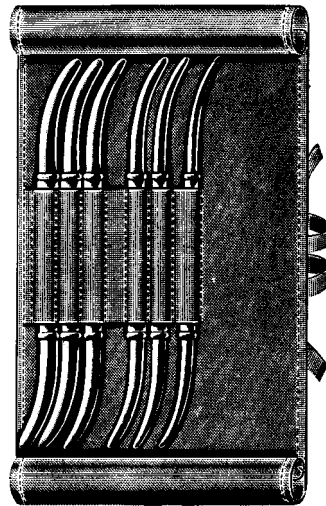


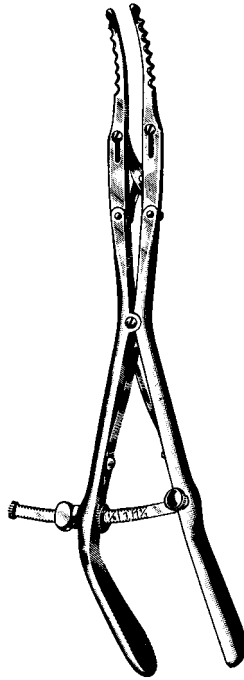
Fig.	mm/Ø	HANK
9/10	4,5/5	71430-10
11/12	5,5/6	71430-12
13/14	6,5/7	71430-14
15/16	7,5/8	71430-16
17/18	8,5/9	71430-18
19/20	9,5/10	71430-20

71436-06
 Satz, set, juego, serie = 6

Fig./U.S.	mm/Ø	PRATT
13/15	4,5/5	71438-13
17/19	5,6/6,3	71438-17
21/23	7/7,6	71438-21
25/27	8,3/9	71438-25
29/31	9,6/10,3	71438-29
33/35	11/11,6	71438-33
37/39	12,3/13	71438-37
41/43	13,6/14,3	71438-41

71438-00
 Satz, set, juego, serie = 8

Uterus Dilatatoren
Uterine Dilators
Dilatadores uterinos
Dilatatori uterini

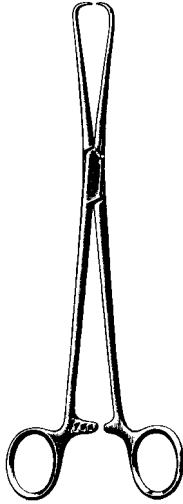


GOZELL
71441-34
34 cm, 13 1/2"

Hakenzangen
 Tenaculum Forceps
 Pinzas para coger el cuello del útero
 Pinze per abbassare il collo dell'utero



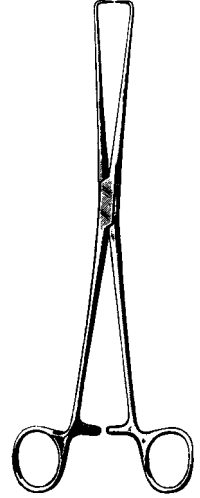
ADAIR
 71500-18
 19 cm, 7 1/2"



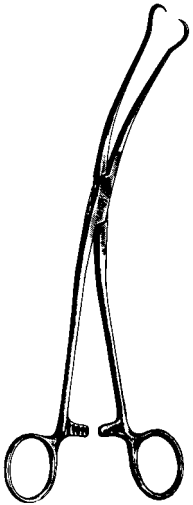
SCHRÖDER (POZZI)
 71502-25
 25 cm, 10"



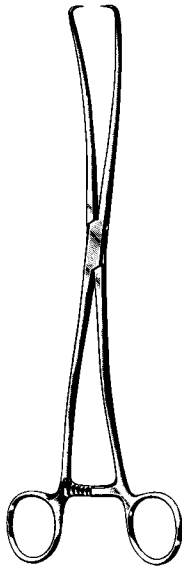
POZZI-PALMER
 71503-25
 25 cm, 10"



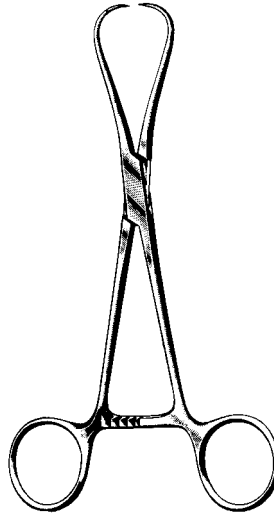
BRAUN
 71504-25
 25 cm, 10"



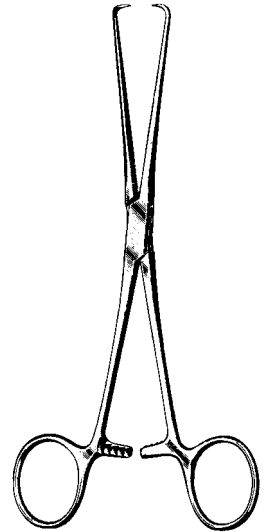
SKENE
 71505-24
 24 cm, 9 1/2"



DUPLAY
 71507-28
 28 cm, 11"

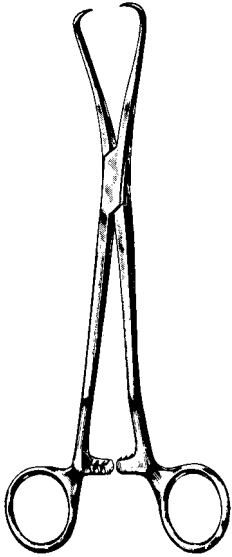


STAUDE-MOORE
 71508-17
 17 cm, 6 3/4"

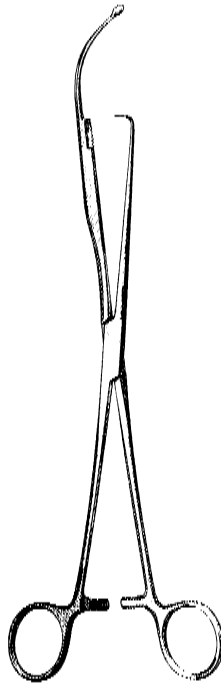


BARRETT
 71510-18
 18 cm, 7"

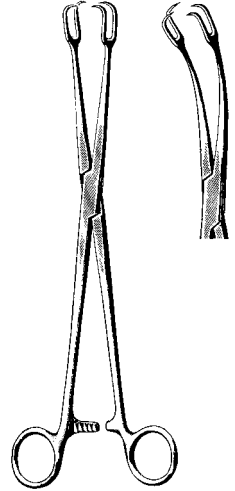
Hakenzangen
 Tenaculum Forceps, Vulsellum Forceps
 Pinzas para coger el cuello del útero
 Pinze per abbassare il collo dell'utero



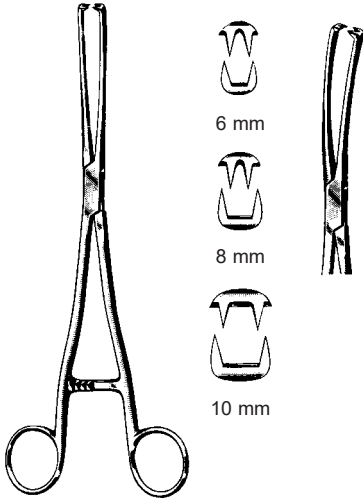
JARCHO
 71512-20
 20 cm, 8"



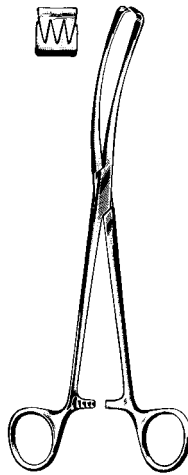
HULKA
 71512-28
 28 cm, 11"



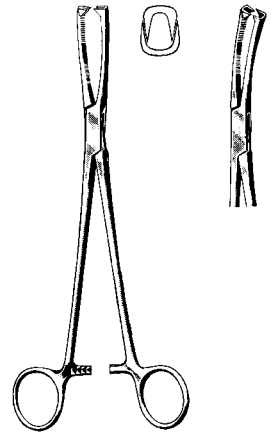
SCHRÖDER
 71514-24 71515-24
 24 cm, 9 1/2"



MUSEUX
 71524-06 6 mm 71525-06
 71524-08 8 mm 71525-08
 71524-10 10 mm 71525-10
 24 cm, 9 1/2"



TEALE
 71531-23
 23 cm, 9"



JACOBS
 71532-21 71533-21
 21 cm, 8 1/4"

Hakenzangen
 Tenaculum Forceps, Vulsellum Forceps
 Pinzas para coger el cuello del útero
 Pinze per abbassare il collo dell'utero



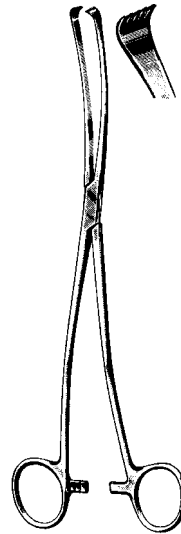
CZERNY
 71536-21
 20 cm, 8"



PRATT
 71536-28
 28 cm, 11"

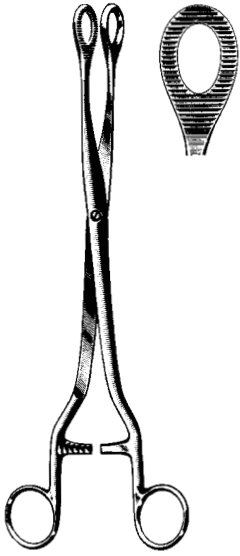


SCHRÖDER
 71537-27
 27 cm, 10 1/2"

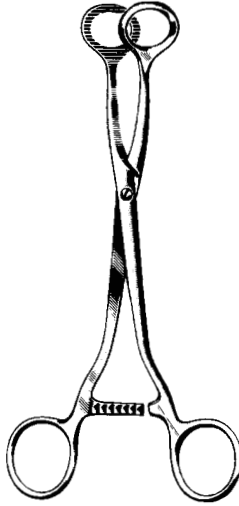


IOWA
 71539-26
 26 cm, 10 1/4"

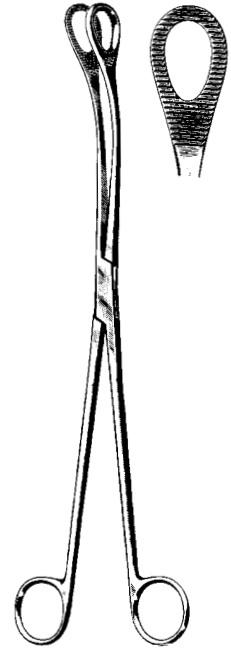
Uterus Polypenzangen, Uterus-Faßzangen
 Uterine Polypus Forceps, Uterine Elevating Forceps
 Pinzas para pólipos uterinos, Pinzas para el útero
 Pinze per polipi uterini, Pinze per afferrare l'utero



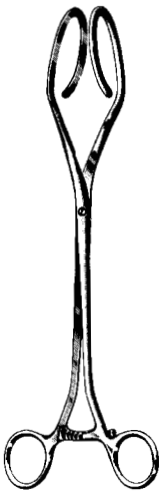
NOTO
 71540-27
 27 cm, 10 1/2"



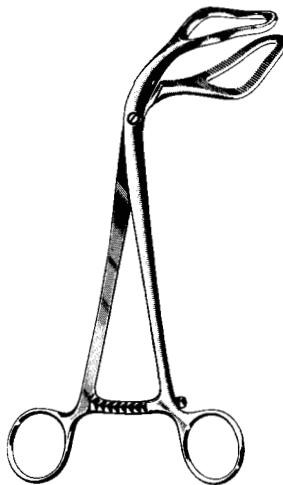
DOYEN
 71542-20
 20 cm, 8"



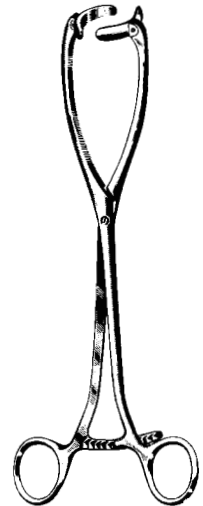
KELLY
 71543-32
 32 cm, 12 3/4"



DARTIGUES
 71545-27
 27 cm, 10 1/2"



SOMER
 71547-23
 23 cm, 9"



COLLIN
 71549-25
 25 cm, 10"

Amniotom, Uterus Depressoren, Uterus-Sonden
 Amniotome, Uterine Depressors, Uterine Sounds
 Amniótomo, Depresores uterinos, Histerómetros
 Amniotomo, Depressori uterini, Isterometri



BEACHAM
 71559-26
 26 cm, 10 1/4"



BRAUN
 71565-28
 28 cm, 11"



SIMS
 71567-26
 26 cm, 10 1/4"



fest
 rigid
 rigido
 rigida
 biegsam
 malleable
 maleable
 malleabile
 SIMS
 71580-32 71581-32
 32 cm, 12 3/4"



fest
 rigid
 rigido
 rigida
 biegsam
 malleable
 maleable
 malleabile
 MARTIN
 71582-32 71583-32
 32 cm, 12 3/4"

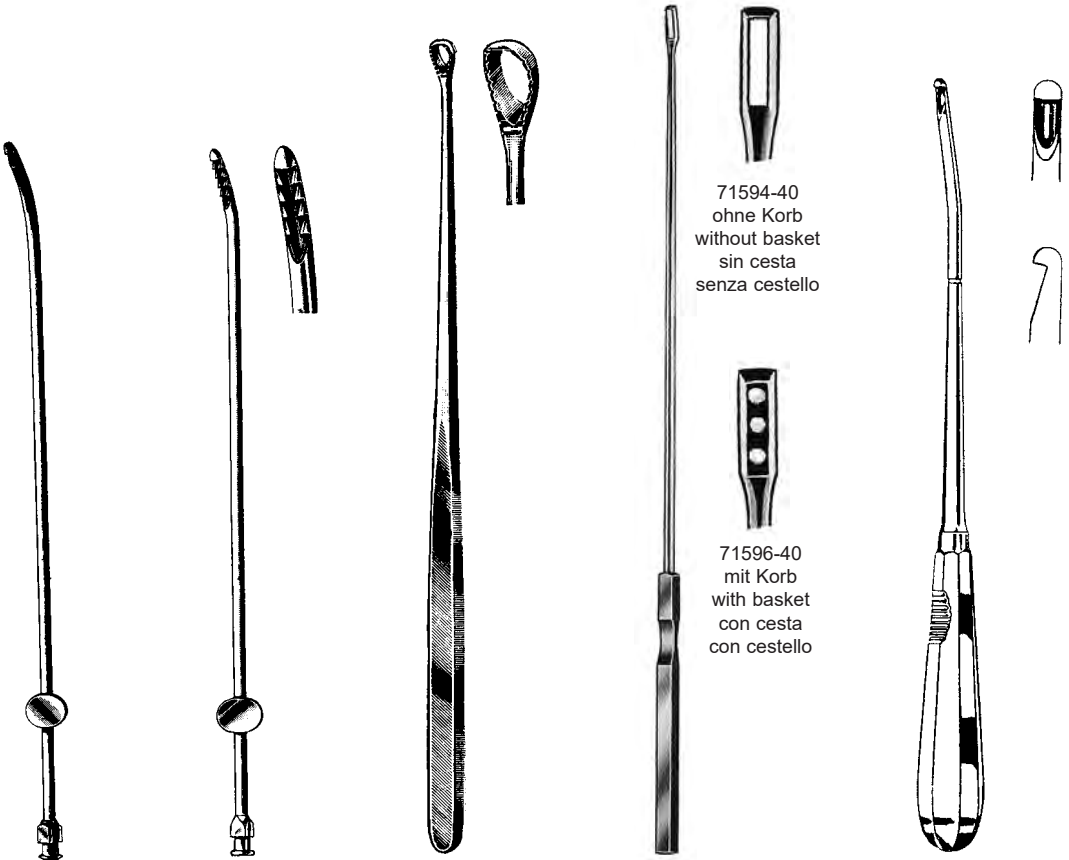


COLLIN
 71584-28
 28 cm, 11"



VALLEIX
 71585-25
 25 cm, 10"

Saugkürretten, Biopsiekürretten
 Biopsy Curettes
 Curetas para biopsia
 Curette per biopsia



RANDALL
 71590-04
 24 cm, 9 1/2"
 Ø 4 mm

NOVAK
 71592-01 Ø 1 mm
 71592-02 Ø 2 mm
 71592-03 Ø 3 mm
 71592-04 Ø 4 mm

HEANY
 71593-00
 22,5 cm, 9"

KEVORKIAN
 4,0 mm
 30 cm, 11 3/4"

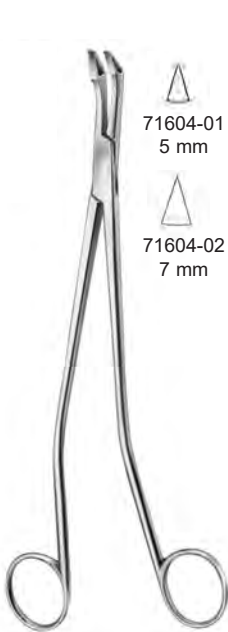
71594-40
 ohne Korb
 without basket
 sin cesta
 senza cestello

71596-40
 mit Korb
 with basket
 con cesta
 con cestello

MOD. MUENCHEN
 71598-27
 27 cm, 10 1/2"

mit Luer-Lock Ansatz
 with Luer-Lock connection
 con conexión Luer-Lock
 con raccordo Luer-Lock

Biopsiezangen
 Biopsy Forceps
 Pinzas para biopsia
 Pinze taglienti per biopsia



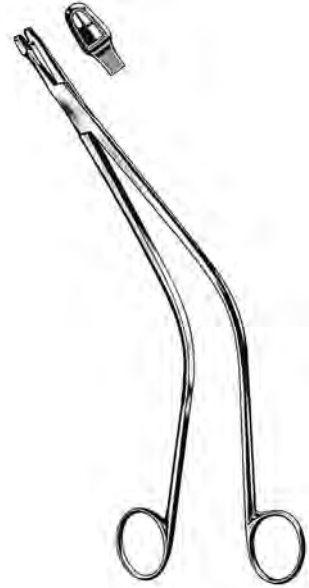
71604-01
5 mm

71604-02
7 mm

SCHUMACHER
24 cm, 9 1/2"



SCHUBERT
71604-21 21 cm, 8 1/4"
71604-28 28 cm, 11"



SCHUBERT
71605-26
26 cm, 10 1/4"



THOMS-GAYLOR
71606-24
24 cm, 9 1/2"

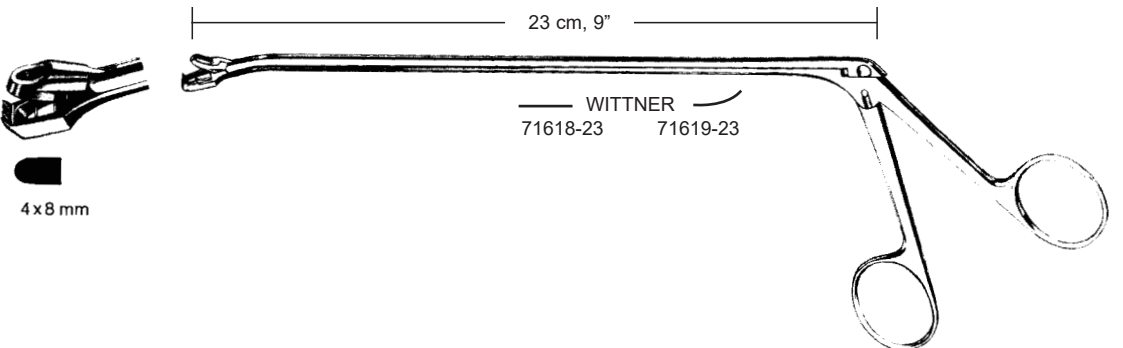
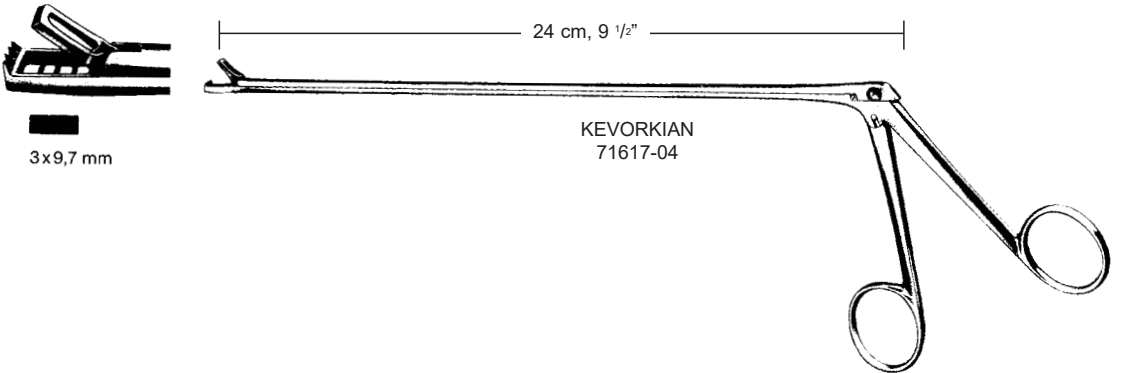
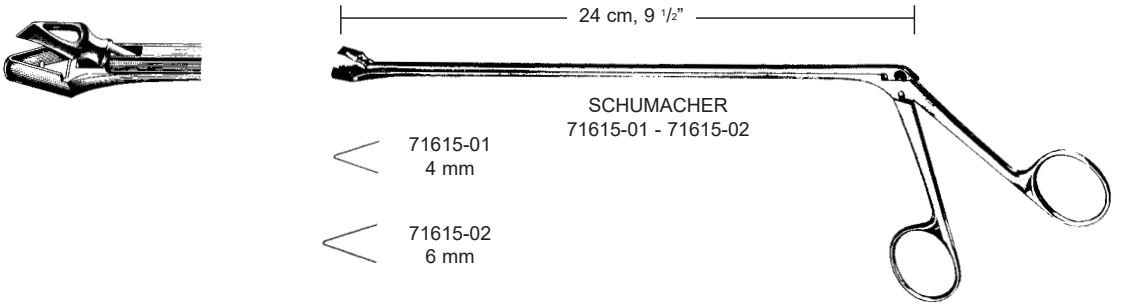
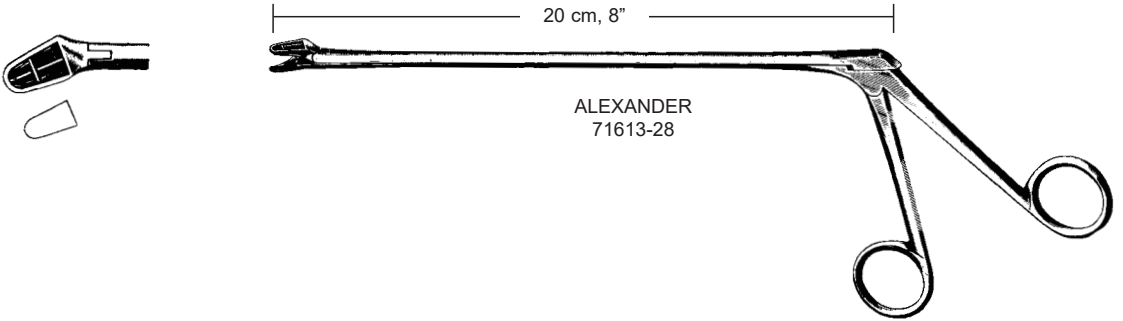


van DOREN
71611-25
25 cm, 10"

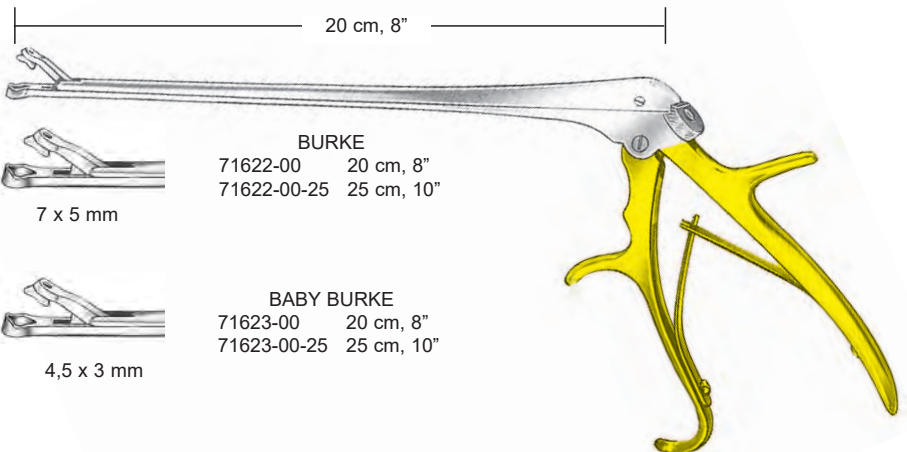
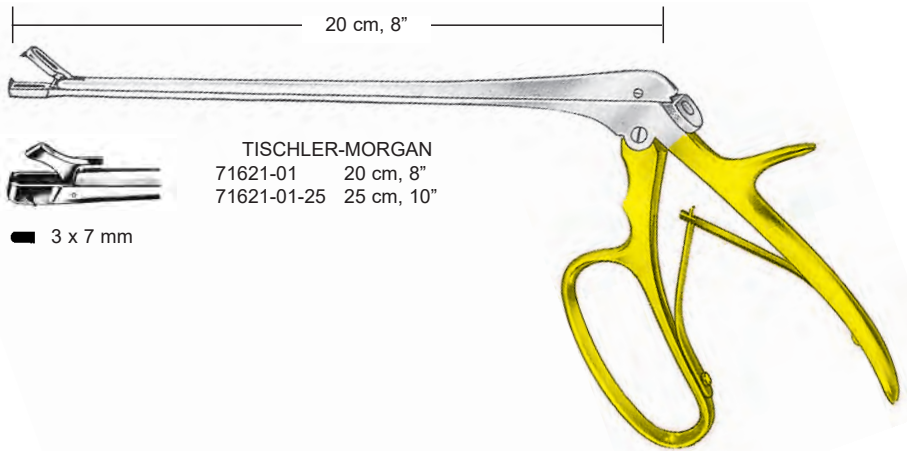
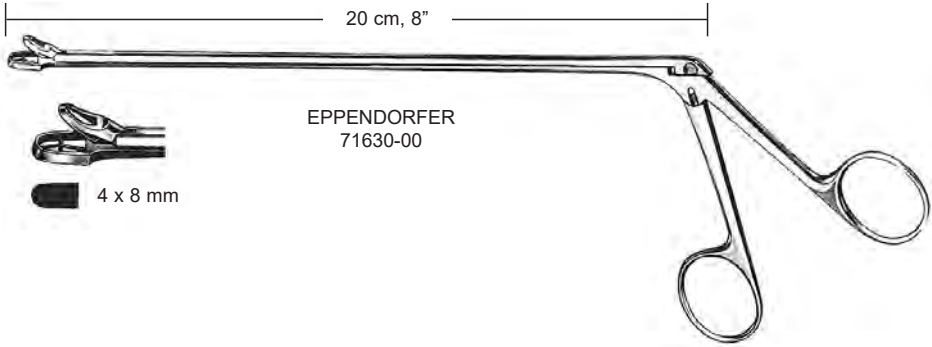


FAURE
71612-21
21 cm, 8 1/4"

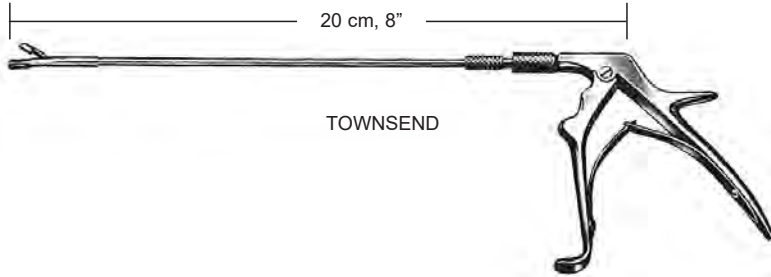
Uterus Biopsiezangen
Biopsy Specimen Forceps
Pinzas para biopsia
Pinze per biopsia



Uterus Biopsiezangen
 Biopsy Specimen Forceps
 Pinzas sacabocado p. biopsia
 Pinze per biopsia



Uterus Biopsiezangen
 Biopsy Specimen Forceps
 Pinzas sacabocado p. biopsia
 Pinze per biopsia



TOWNSEND

71624-10
 Griff allein
 Handle only
 Mango solo
 Manico solo



TISCHLER-MORGAN



TISCHLER-UP



oval ● 3,7x5 mm



TISCHLER-DOWN



KEVORKIAN



MINI-TOWNSEND-UP



mini



MINI-TOWNSEND-DOWN

Fig.	Strumento completo	Asta operativa sola
1	71624-01	71624-11
3	71624-03	71624-13
4	71624-04	71624-14
5	71624-05	71624-15
6	71624-06	71624-16
7	71624-07	71624-17
8	71624-08	71624-18
9	71624-09	71624-19

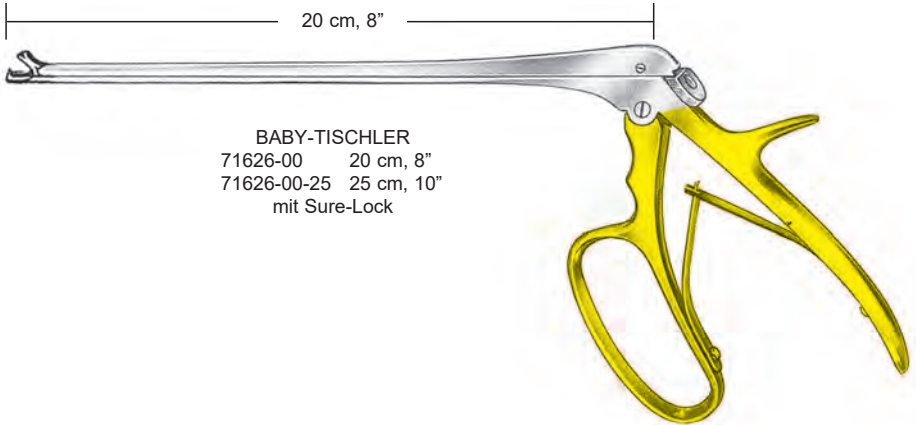
komplett
 compl. instr.
 Instrum. compl.

Aufsatz allein
 Tip only
 Punta sola

Uterus Biopsiezangen
 Biopsy Specimen Forceps
 Pinzas sacabocado p. biopsia
 Pinze per biopsia



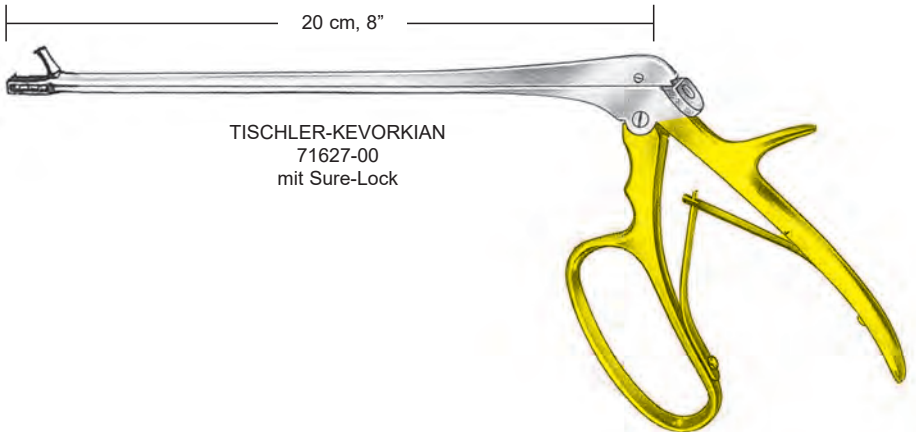
2,3 x 4,2 mm



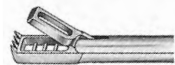
BABY-TISCHLER
 71626-00 20 cm, 8"
 71626-00-25 25 cm, 10"
 mit Sure-Lock



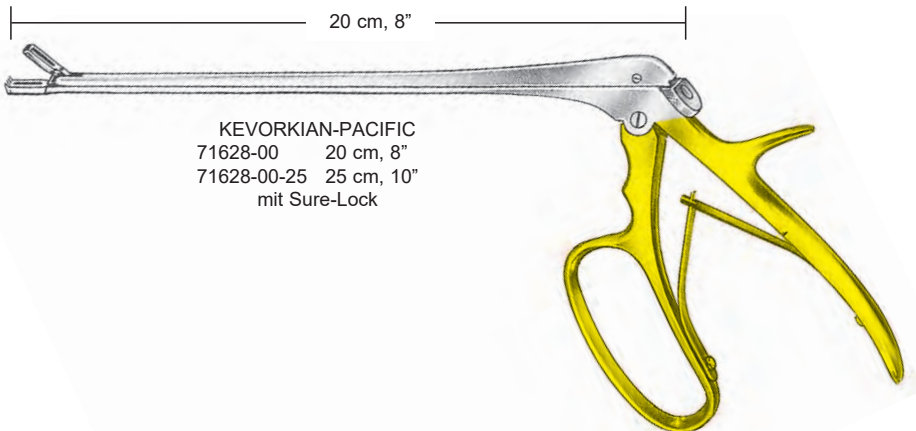
3 x 9,5 mm



TISCHLER-KEVORKIAN
 71627-00
 mit Sure-Lock

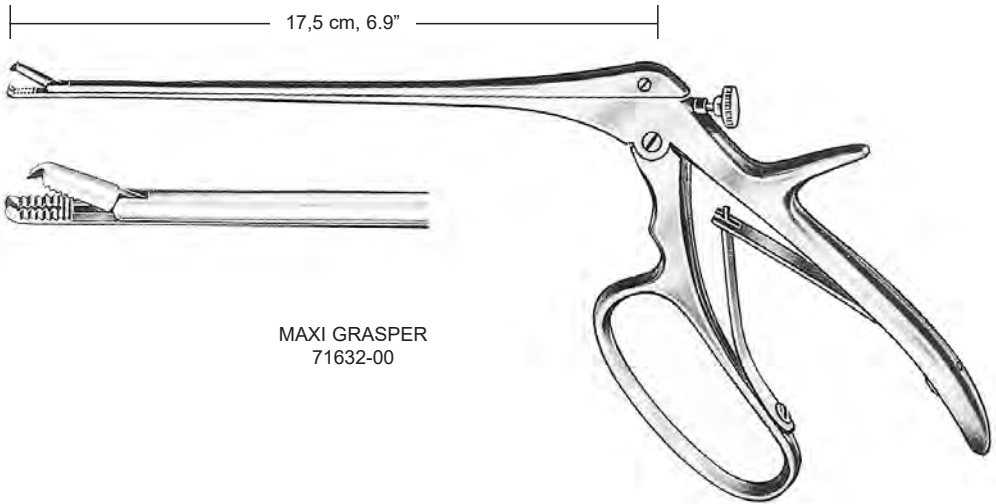


3 x 8 mm

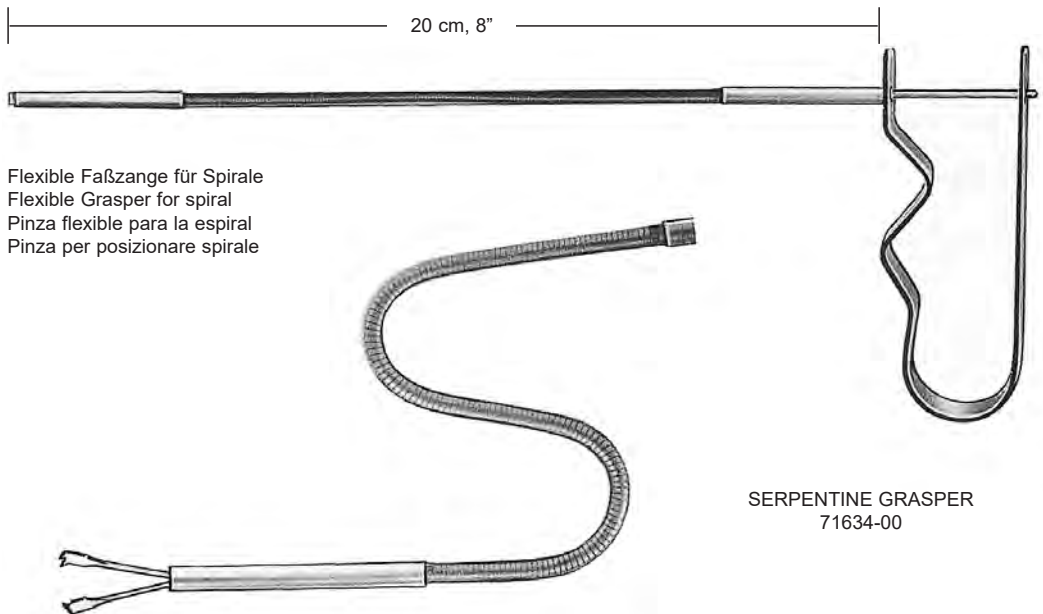


KEVORKIAN-PACIFIC
 71628-00 20 cm, 8"
 71628-00-25 25 cm, 10"
 mit Sure-Lock

Uterus Biopsiezangen
Biopsy Specimen Forceps
Pinzas sacabocado p. biopsia
Pinze per biopsia



MAXI GRASPER
71632-00



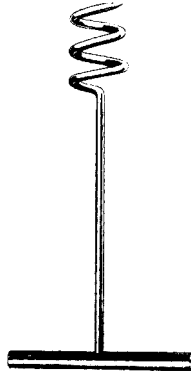
Flexible Faßzange für Spirale
Flexible Grasper for spiral
Pinza flexible para la espiral
Pinza per posizionare spirale

SERPENTINE GRASPER
71634-00



I.U.D.
Extractor Hook
71635-26
26 cm, 10 1/4"

Myomeheber, Fistelhäkchen, Meßinstrumente, Uteruslöffel
 Myoma Screw, Fistula Hook, Measuring Instruments, Uterine Curettes
 Tirabuzón para fibromas, Ganchos para fistulas, Instrumental para medir, Curetas uterinas
 Tiramiomi, Uncini per fistole, Strumenti per misure, Curette uterine



DOYEN
 71641-17
 17 cm, 6 3/4"



EMMET
 71645-01 - 71645-03
 22 cm, 8 3/4"



71645-01
 Fig. 1



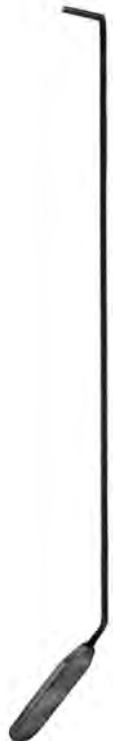
71645-02
 Fig. 2



71645-03
 Fig. 3



71646-01



71646-02



scharf
 sharp
 cortante
 tagliente



1



2



3



4



5



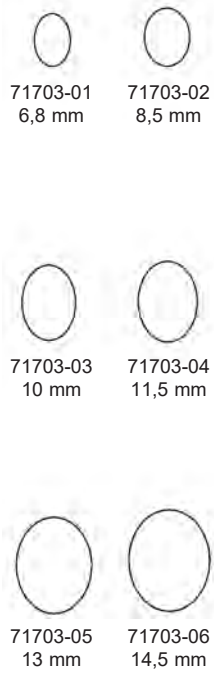
6

Fig.	SIMON	
1	71702-01	6,8 mm
2	71702-02	8,5 mm
3	71702-03	10,0 mm
4	71702-04	11,5 mm
5	71702-05	13,0 mm
6	71702-06	14,5 mm
		25 cm, 10"

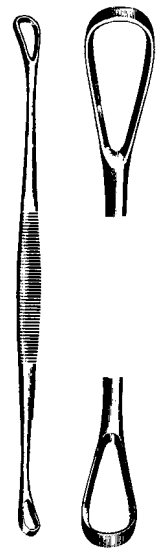
Uterus-Küretten
Uterine Curettes
Curetas uterinas
Curette uterine



SCHRÖDER
31 cm, 12 1/4"



scharf/stumpf
sharp/blunt
cortante/roma
tagliente/smussa



BLAKE
71704-27
27 cm, 10 1/2"

Salpingograph
Salpingograph
Salpingógrafo
Salpingografo

71650-00

SCHULTZE Salpingograph bestehend aus:

- 71650-01 1 Tubenkatheter
- 71650-02 1 Zwischenstück
- 71650-03 1 Manometer
- 71650-04 1 Kegel, klein
- 71650-05 1 Kegel, mittel
- 71650-06 1 Kegel, groß

SCHULTZE salpingograph compl.:

- 71650-01 1 Tubal catheter only
- 71650-02 1 connecting piece
- 71650-03 1 manometer
- 71650-04 1 cone small
- 71650-05 1 cone medium
- 71650-06 1 cone large

Salpingógrafo compuesto de:

- 71650-01 1 cateter de tubo
- 71650-02 1 pieza de conexion
- 71650-03 1 manometro
- 71650-04 1 cono pequeño
- 71650-05 1 cono mediano
- 71650-06 1 cono grande

Salpingografo composto da:

- 71650-01 1 Catetere per tubo
- 71650-02 1 Raccordo
- 71650-03 1 Manometro
- 71650-04 1 Cono, piccolo
- 71650-05 1 Cono, medio
- 71650-06 1 Cono, grande

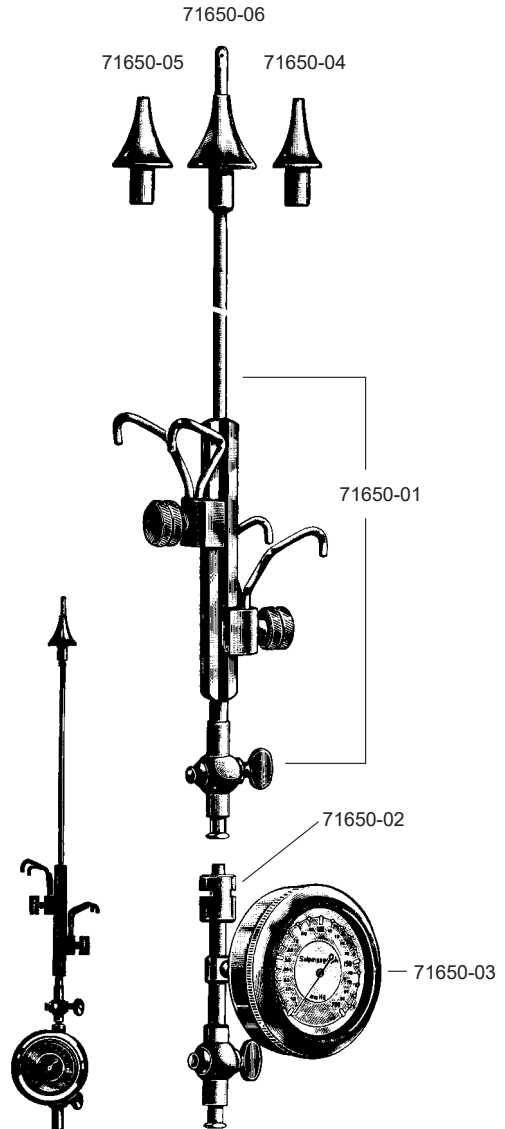
71660-00

Schultze Salpingograph, jedoch ohne Manometer

Schultze Salpingograph without manometer

Schultze Salpingografo sin manometro

Schultze Salpingografo senza manometro



SCHULTZE
71650-00
compl.

im Etui
in case
en estuche
in astuccio

Uterus-Küretten
 Uterine Curettes
 Curetas uterinas
 Curette Uterine



SIMS
 71710-05 - 71717-14
 28 cm, 11"

	scharf sharp cort. tagl.	Fig.	mm	stumpf blunt roma smussa
fest	71710-05	00	5,0	71715-05
rig.	71710-06	0	6,0	71715-06
	71710-07	1	7,5	71715-07
	71710-08	2	8,5	71715-08
	71710-09	3	10,0	71715-09
	71710-11	4	11,5	71715-11
	71710-12	5	13,5	71715-12
	71710-14	6	14,5	71715-14



RECAMIER
 71720-05 - 71727-20
 31 cm, 12 1/4"

	scharf sharp cort. tagl.	Fig.	mm	stumpf blunt roma smussa
fest	71720-05	00	5	71725-05
rig.	71720-06	0	6	71725-06
	71720-07	1	7	71725-07
	71720-08	2	8	71725-08
	71720-09	3	9	71725-09
	71720-11	4	11	71725-11
	71720-12	5	12	71725-12
	71720-14	6	14	71725-14
	71720-15	7	15	71725-15
	71720-16	8	16	71725-16
	71720-19	9	19	71725-19
	71720-20	10	20	71725-20



BUMM
 71730-30 - 71737-40
 35 cm, 13 3/4"

	scharf sharp cort. tagl.	Fig.	stumpf blunt roma smussa
fest	71730-30	14	71735-30
rig.	71730-35	15	71735-35
	71730-40	16	71735-40

flexibel	71712-05	00	5,0	71717-05
flexible	71712-06	0	6,0	71717-06
fless.	71712-07	1	7,5	71717-07
	71712-08	2	8,5	71717-08
	71712-09	3	10,0	71717-09
	71712-11	4	11,5	71717-11
	71712-12	5	13,5	71717-12
	71712-14	6	14,5	71717-14

flexibel	71722-05	00	5	71727-05
flexible	71722-06	0	6	71727-06
fless.	71722-07	1	7	71727-07
	71722-08	2	8	71727-08
	71722-09	3	9	71727-09
	71722-11	4	11	71727-11
	71722-12	5	12	71727-12
	71722-14	6	14	71727-14
	71722-15	7	15	71727-15
	71722-16	8	16	71727-16
	71722-19	9	19	71727-19
	71722-20	10	20	71727-20

flexibel	71732-30	14	71737-30
flexible	71732-35	15	71737-35
fless.	71732-40	16	71737-40

Uterus-Küretten
 Uterine Curettes
 Curetas uterinas
 Curette uterine

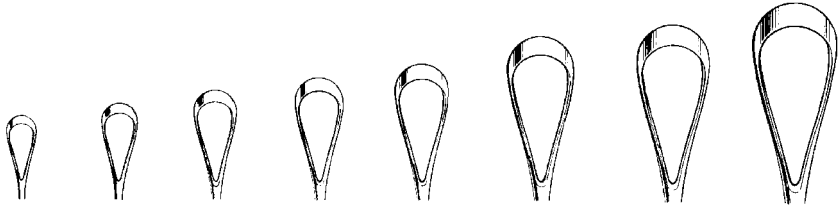


Fig.	00	0	1	2	3	4	5	6
mm	5	6	7	8	9	11	12	14

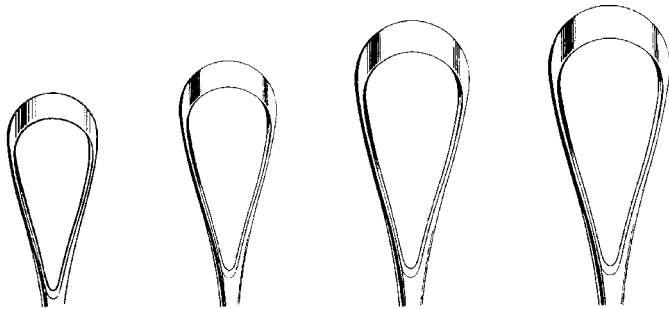


Fig.	7	8	9	10
mm	15	16	19	20

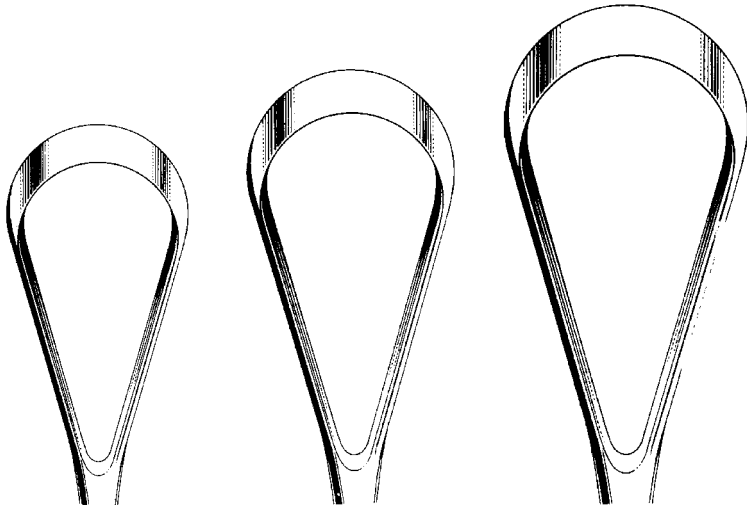
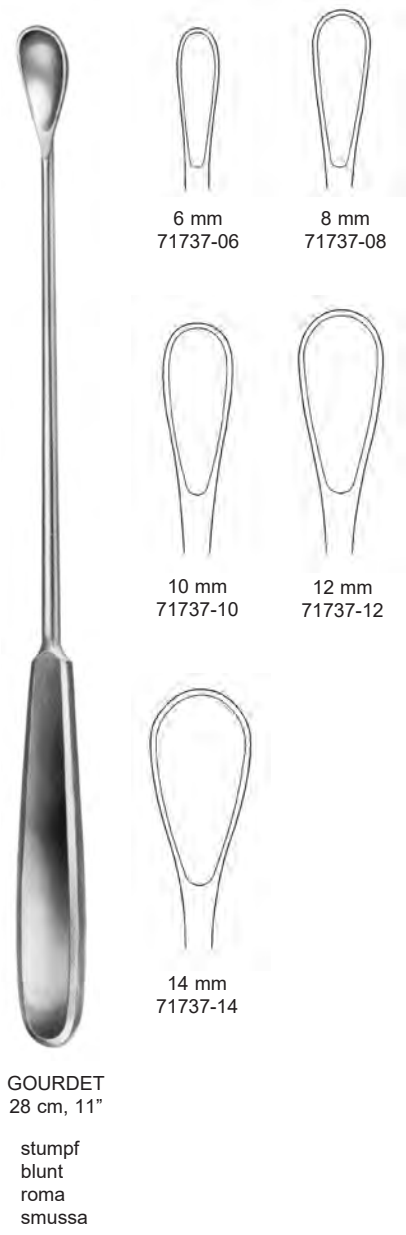
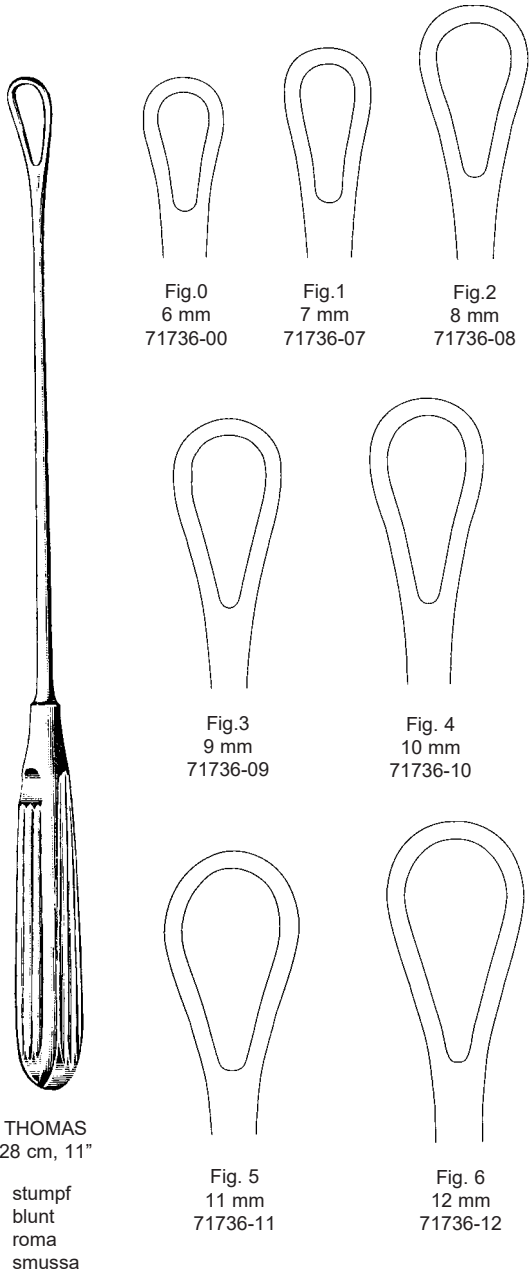


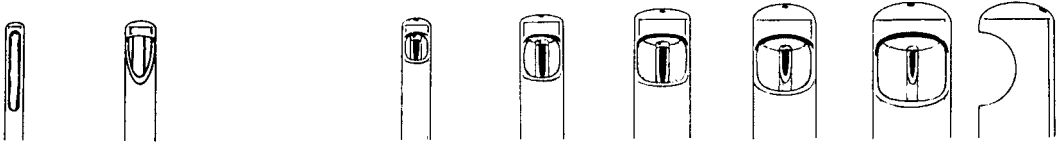
Fig.	14	15	16
mm	30	35	40

SIMS
 RECAMIER
 BUMM
 71710-05 - 71737-40

Uterus-Küretten
 Uterine Curettes
 Curetas uterinas
 Curette uterine



Biopsie- und Absaugküretten, Schlauch-Verbindungsstück
 Specimen and Aspirating Curettes, Hose connecting piece
 Curetas para biopsia y aspiración, Pieza conexión para tubos
 Curette di aspirazione per biopsia, Raccordo di connessione per tubi



71803-03
3 mm Ø

71803-04
4,5 mm Ø

71803-06
6 mm Ø

71803-08
8 mm Ø

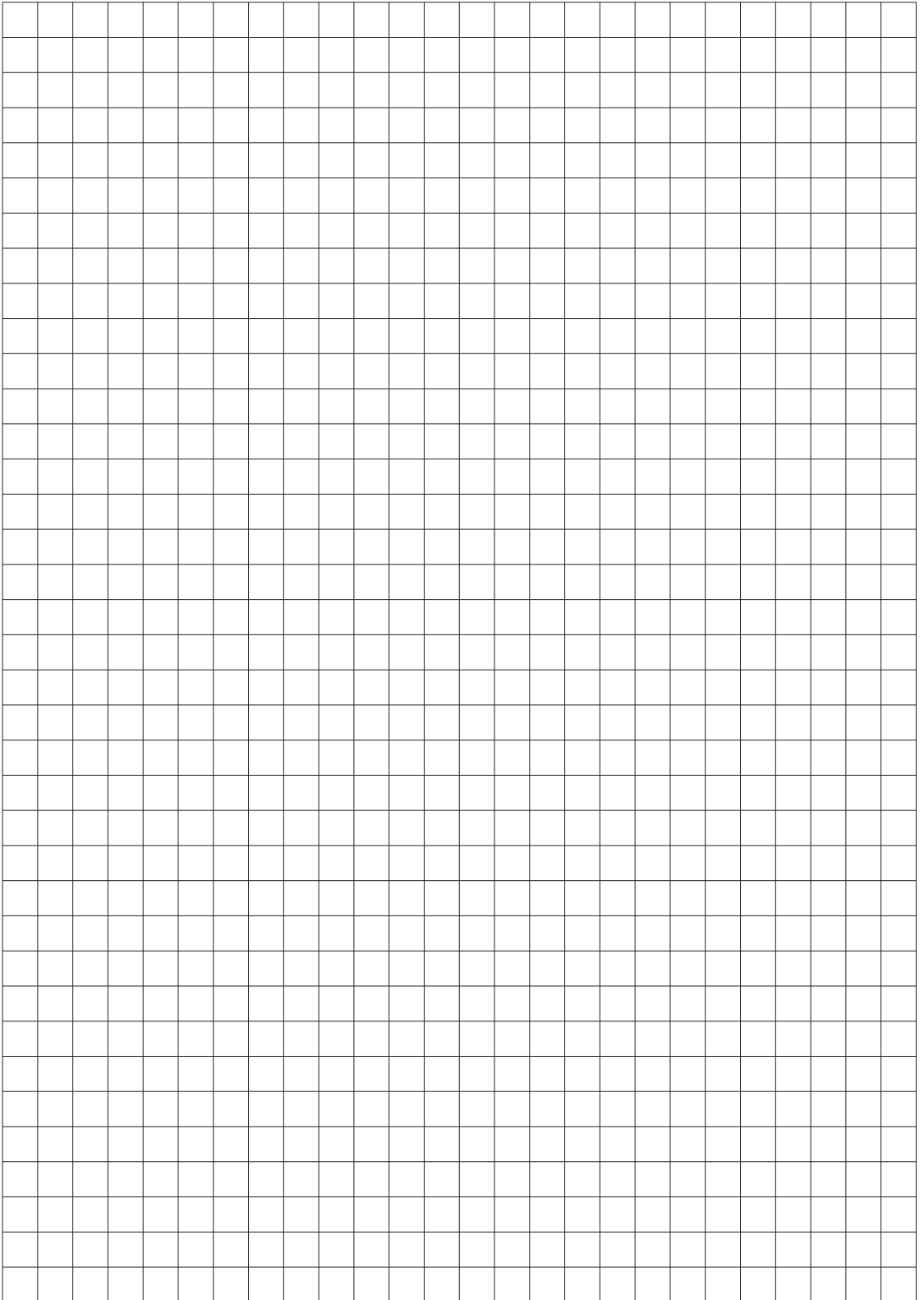
71803-10
10 mm Ø

71803-12
12 mm Ø

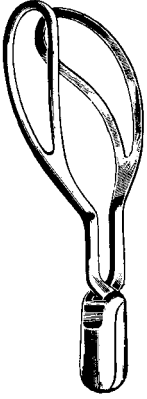
71803-14
14 mm Ø



71803-15



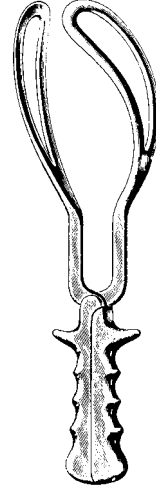
Geburtszangen
Obstetrical Forceps
Forceps obstétricos
Forcipi



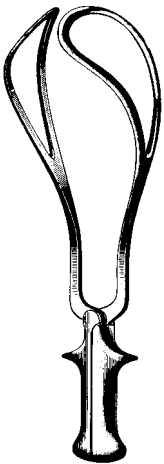
WRIGLEY
73101-23
23 cm, 9"



SIMPSON
73102-30
30 cm, 11 3/4"



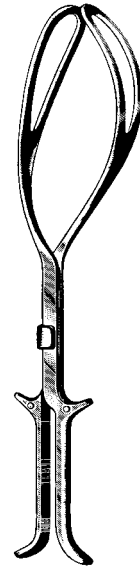
SIMPSON-BRAUN
73105-33 33 cm, 13"
73105-36 36 cm, 14"



De LEE
73107-30
30 cm, 11 3/4"

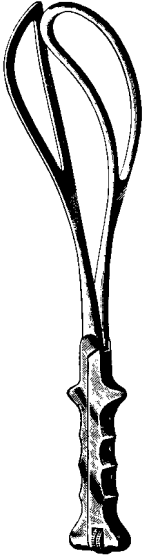


De LEE
73108-36
36 cm, 14"

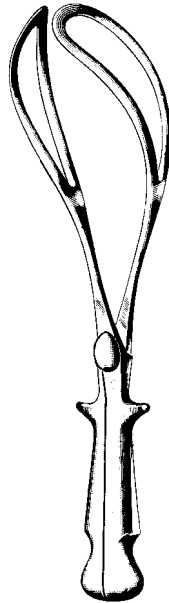


KIELLAND
73110-41
41 cm, 16"

Geburtszangen
Obstetrical Forceps
Forceps obstétricos
Forcipi



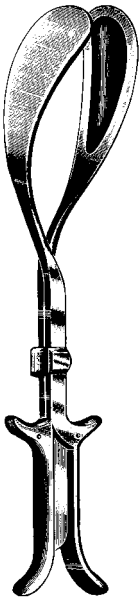
ELLIOT
73115-32 32 cm, 12 3/4"



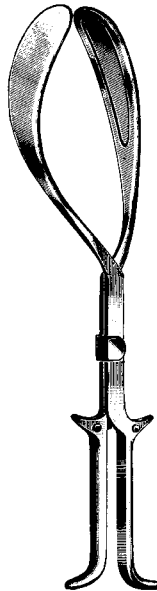
NAEGELE
73119-36 36 cm, 14"
73119-40 40 cm, 15 3/4"



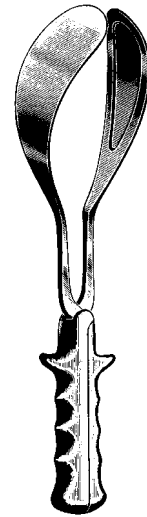
THIERRY
73123-39 39 cm, 15 1/2"



LUIKART
73125-40
40 cm, 15 3/4"

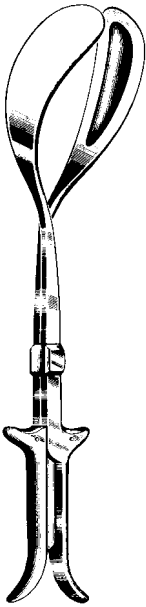


KIELLAND-LUIKART
73127-40
40 cm, 15 3/4"

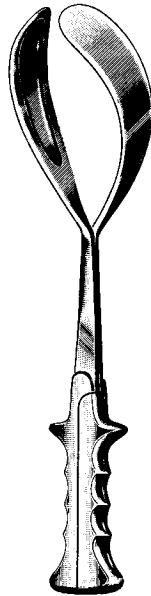


SIMPSON-LUIKART
73135-36
36 cm, 14"

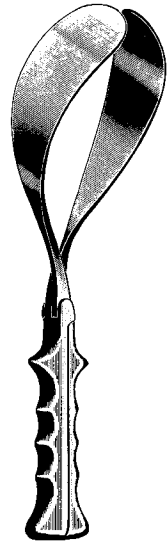
Geburtszangen
Obstetrical Forceps
Forceps obstétricos
Forcipi



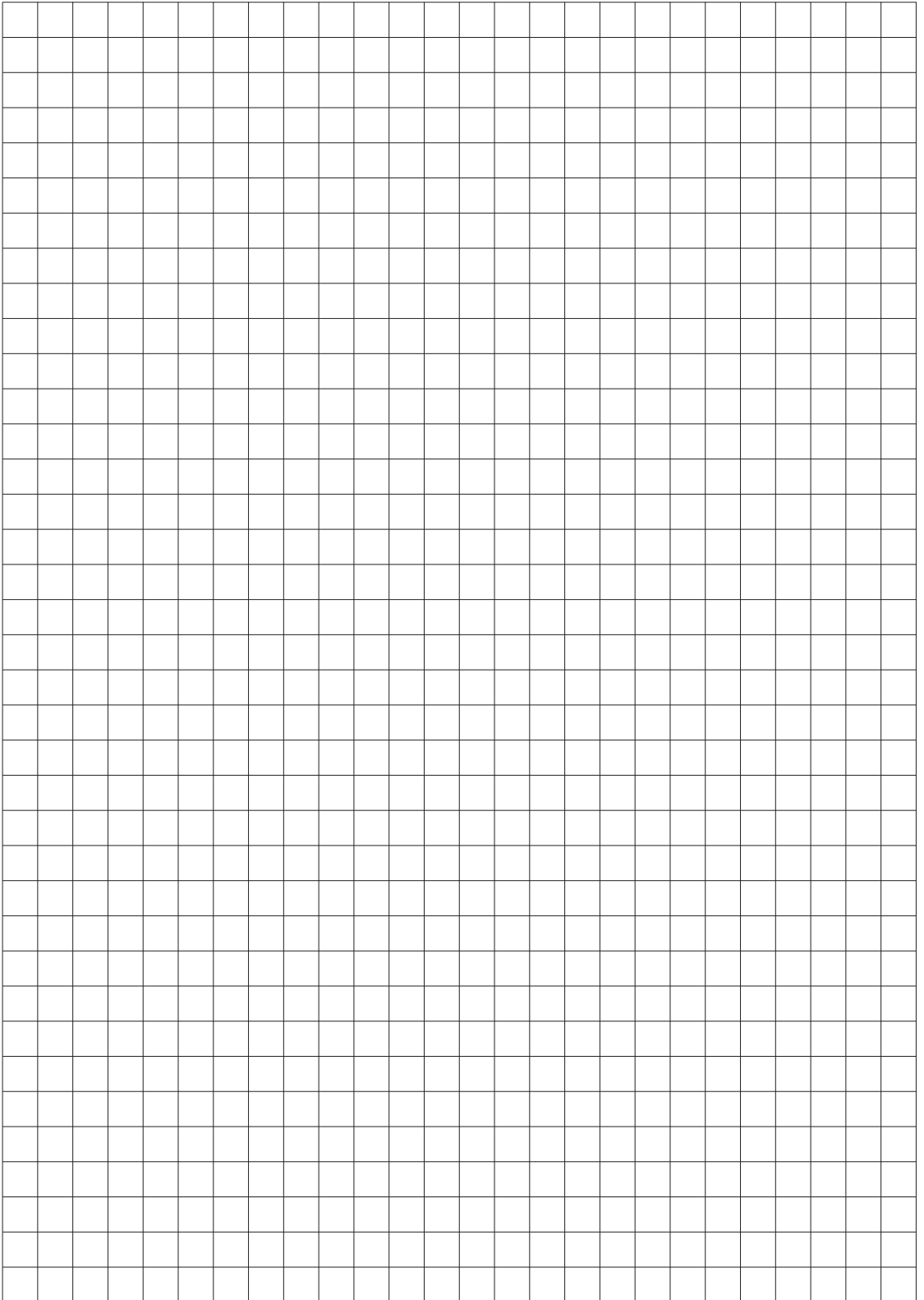
McLEAN-TUCKER-LUIKART
73139-40
40 cm, 15 3/4"



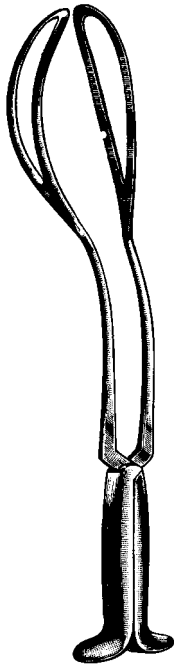
McLEAN-LUIKART
73143-39
39 cm, 15 1/2"



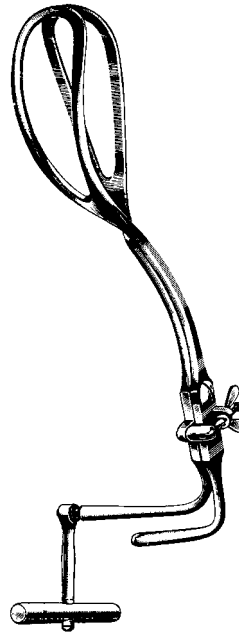
McLEAN
73145-36
36 cm, 14"



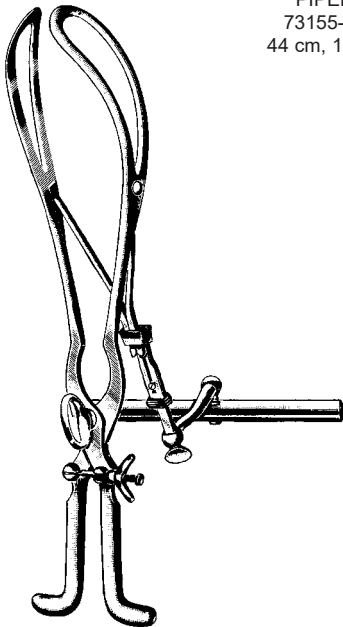
Geburtszangen, Zughebel
 Obstetrical Forceps, Traction handles
 Forceps obstétricos, Dispositivos de tracción
 Forcipi, Leve per trazione



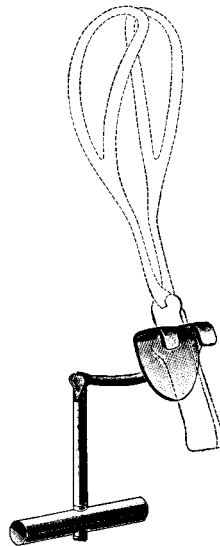
PIPER
 73155-44
 44 cm, 17 1/4"



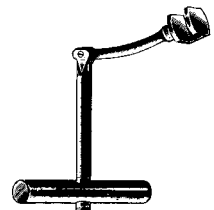
PIPER
 73157-40
 40 cm, 15 3/4"



TARNIER
 73162-40
 40 cm, 15 3/4"



BILL
 73170-00
 21 cm, 8 1/4"

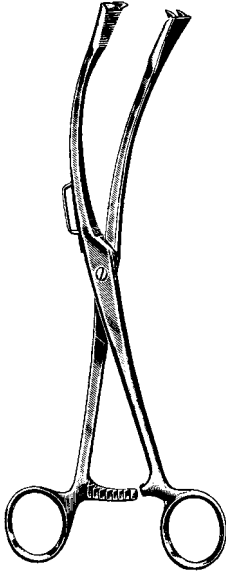


LIJKART-BILL
 73171-21
 21 cm, 8 1/4"

Geburtshaken, Kopfschwartzangen, Uterus-Klemmzange, Nabelschnurklemmen, Beckenzirkel
 Scalp flap forceps, Uterine haemostatic forceps, Umbilical cord clamps, Pelvimeters
 Pinzas para cuero cabelludo, Pinzas-clamps uterinas para hemóstasis, Clamp umbilical, Pelvímetros
 Pinza per il cuoio capelluto, Pinza uterina, Pinza ombelicale, Pelvimetri



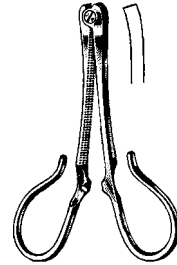
SMELLIE
 73181-33
 33 cm, 13"



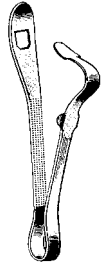
GAUSS
 73183-27
 27 cm, 10 1/2"



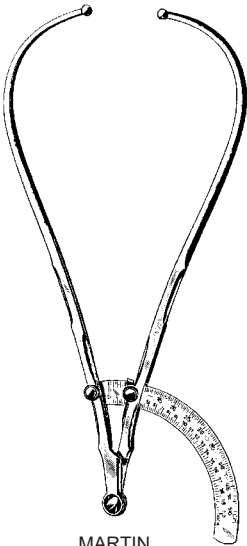
GREEN-ARMYTAGE
 73184-21
 21 cm, 8 1/4"



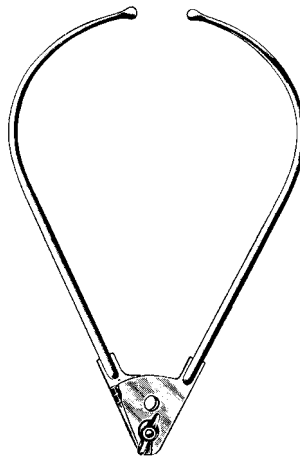
KANE
 73189-09
 8,5 cm, 3 1/4"



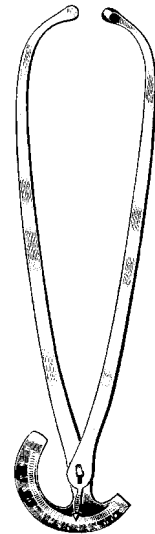
COLLIN
 73187-09
 9 cm, 3 1/2"



MARTIN
 73191-34
 34 cm, 13 1/2"

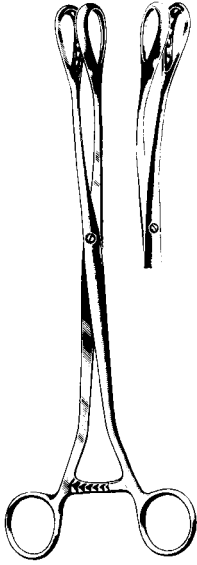


COLLIER
 73193-30
 30 cm, 11 3/4"



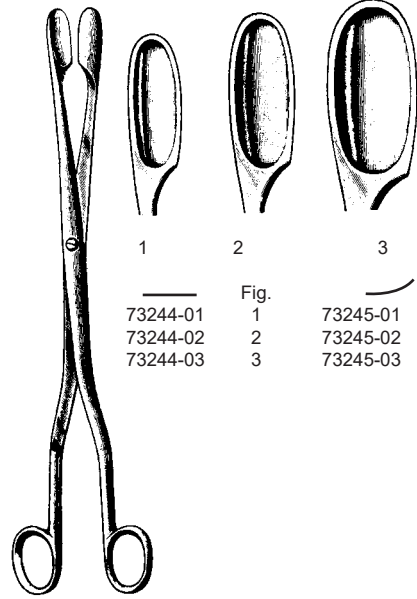
COLLIN
 73195-35
 35 cm, 14"

Abortuszangen, Abortuslöffel
 Ovum Forceps, Abortion Scoops
 Pinzas para aborto, Cucharillas para aborto
 Ostetricia, Curette per aborto



SAENGER

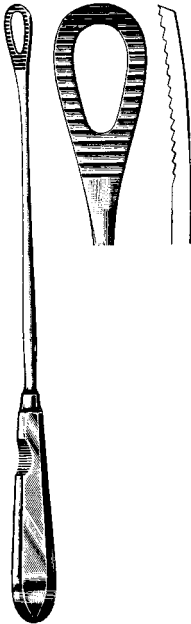
73242-27 73243-27
 27 cm, 10 1/2"



WINTER

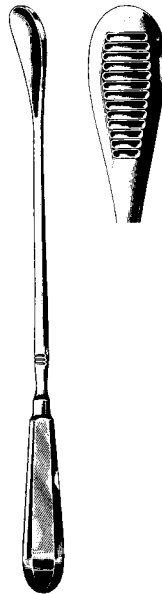
73244-01 - 73245-03
 28 cm, 11"

	Fig.	
73244-01	1	73245-01
73244-02	2	73245-02
73244-03	3	73245-03



PESTALOZZA

73252-30
 30 cm, 11 3/4"



CUZZI

73254-14 - 73254-21
 30 cm, 11 3/4"



73254-14
 14,5 mm



73254-18
 18 mm



73254-21
 21 mm

Abortuslöffel, Geburtslöffel, Basiotrip, Perforatorium, Dekapitationshaken
 Abortion Scoops, Elevating Spoon, Basiotribe, Perforators, Decapitating hook
 Cucharillas para aborto, Separador obstetrico, Basiotribo, Perforacráneos, Gancho para decapitación
 Curette per aborto, Cucchiaino Ostetrico, Basiotribo, spezzacrani, Uncino per decapitazione



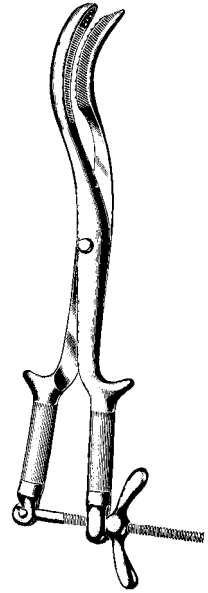
stumpf
 blunt
 roma
 smussa



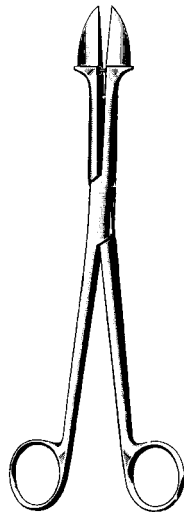
WALLICH
 73256-42
 42 cm, 16 1/2"



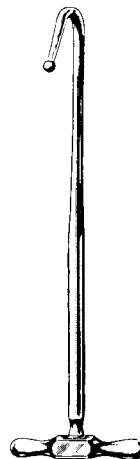
SELLHEIM
 73259-28
 28 cm, 11"



BRAUN
 73302-42
 42 cm, 16 1/2"



SMELLIE
 73306-25
 25 cm, 10"

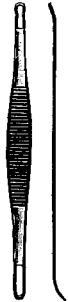


BRAUN
 73309-30
 30 cm, 11 3/4"

Hauthäkchen, Komedonenquetscher, Lupusküretten, Hautküretten, Haut-Trephinen
 Skin hooks, Comedone extractors, Lupus curettes, Skin curettes, Cutaneous punches
 Ganchos cutáneos, Saca comedones, Curetas para lupus, Curetas cutáneas, Trépanos cutáneos
 Uncini cutanei, Schiaccia comedoni, Curette per lupus, Curette cutanee, Trefine cutanee



KILNER
75103-15
15 cm, 6"



SCHAMBERG
75111-10
10 cm, 4"



UNNA
75113-14
14 cm, 5 1/2"



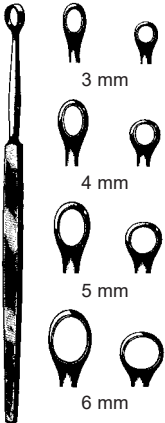
UNNA
75115-14
14 cm, 5 1/2"



WALTON
75118-14
14 cm, 5 1/2"

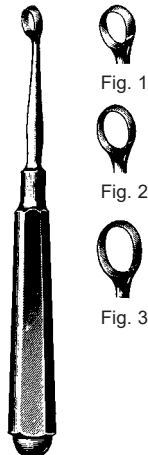


SAALFELD
75121-10
10 cm, 4"

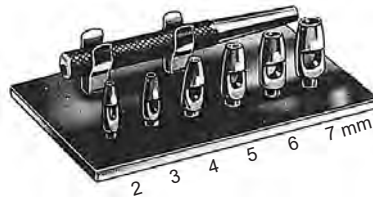


14 cm, 5 1/2"

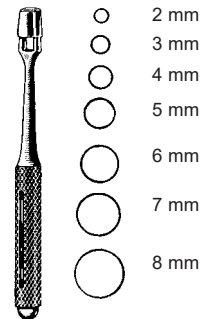
FOX		FOX	
75128-01	1 mm	75129-01	1 mm
75128-02	2 mm	75129-02	2 mm
75128-03	3 mm	75129-03	3 mm
75128-04	4 mm	75129-04	4 mm
75128-05	5 mm	75129-05	5 mm
75128-06	6 mm	75129-06	6 mm



PIFFARD
14,5 cm, 5 1/4"
75130-01 Fig. 1
75130-02 Fig. 2
75130-03 Fig. 3

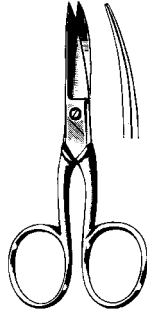


75138-00
Satz komplett mit 6 Aufsätzen
Set complete with 6 tips
Juego con 6 puntas
Serie completa con 6 trefini



KEYES
10 cm, 4"
75140-02 2 mm
75140-03 3 mm
75140-04 4 mm
75140-05 5 mm
75140-06 6 mm
75140-07 7 mm
75140-08 8 mm

Nagelzangen, -Scheren
 Nail Nippers, Scissors
 Alicates corta-uñas
 Tronchesini forbici per unghie



75304-10 10 cm, 4" 75305-10



75331-14
 14 cm, 5 1/2"
 stainless

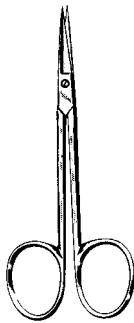


TURNBULL
 75341-11 11,5 cm, 4 1/2"
 75341-13 13,5 cm, 5 1/4"
 stainless

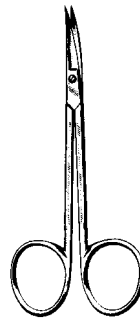
Nagelhautzangen, Hautscheren
Cuticle Nippers, Cuticle Scissors
Pinzas y Tijeras cuticulares
Tronchesine per unghie e pelle



75373-10
10,5 cm, 4"

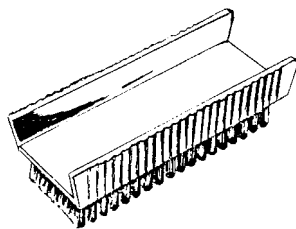


75378-10
10 cm, 4"



75379-10
10 cm, 4"

Handwaschbürsten
Nail brushes
Cepillo para uñas
Spazzole per unghie



75397-00

Pack. à 10 St.
Box of 10 pcs
caja de 10 pzas.
confezione da 10 pezzi

Hygiene
Hygiene
Higiene
Igiene



PROBE AND PACKER
75450-00
14,5 cm, 5^{3/4}"



SPATULA AND PACKER
75440-00
14,5 cm, 5^{3/4}"



mit Loch, with hole,
con agujero, con foro

75430-12 = 1,5 mm + 2,0 mm
75430-13 = 1,5 mm + 2,5 mm
13,5 cm, 5"



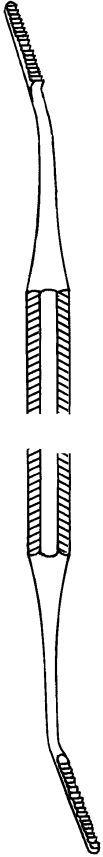
14,5 cm, 5^{3/4}"
ohne Loch, without hole,
sin agujero, senza foro

75400-01 = 1,0 mm
75400-02 = 1,5 mm
75400-03 = 2,0 mm
75400-04 = 2,5 mm

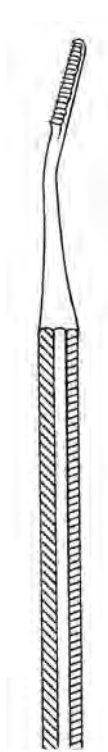
mit Loch, with hole,
con agujero, con foro

75410-01 = 1,0 mm
75410-02 = 1,5 mm
75410-03 = 2,0 mm
75410-04 = 2,5 mm

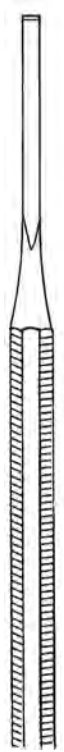
Hygiene
Hygiene
Higiene
Igiene



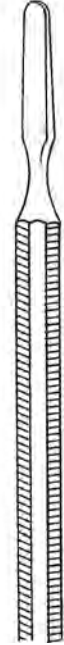
75410-15
17,5 cm, 6 3/4"



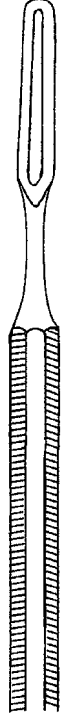
75420-15
15 cm, 6"



75430-01
12,5 cm, 5"



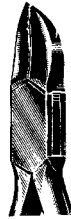
75440-11
11,5 cm, 4 1/2"



INGROWN
75445-12
12,5 cm, 5"

Nagelzangen
Nail Nippers
Alicates corta-uñas
Tronchesini per unghie

stainless steel



75450-13
concave



75460-13
gerade
straight
recto
retta



14,5 cm, 5 3/4"

stainless steel



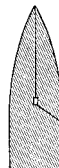
75470-11
10 cm
4"



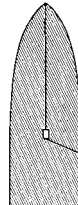
75475-11
11,5 cm
4 1/2"



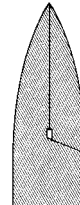
75480-13
12,5 cm
5"



fine
75485-13
12,5 cm
5"



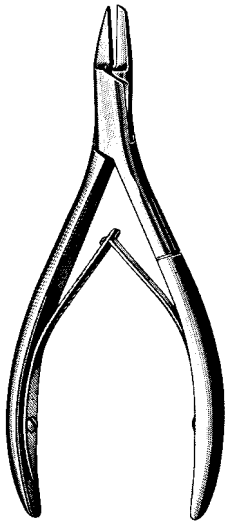
75490-15
15 cm
6"



fine
75500-15
15 cm
6"

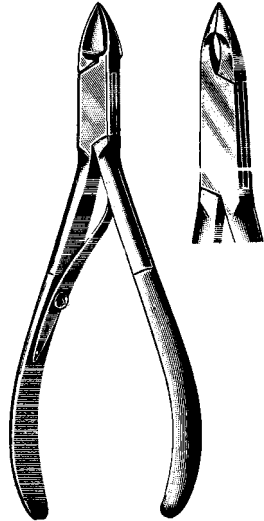
Nagelzangen
Nail Nippers
Alicates corta-uñas
Tronchesini per unghie

stainless steel



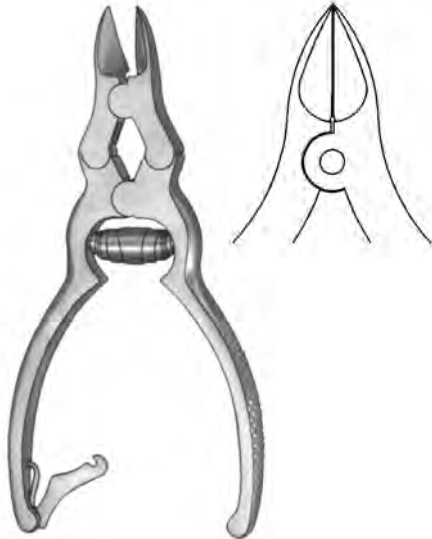
ANVIL
75550-13
13 cm, 5 1/8"

stainless steel



75600-10 10 cm, 4"
75600-13 13 cm, 5 1/8"

stainless steel

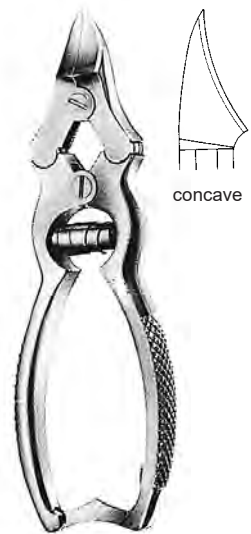


75618-15
15,2 cm, 6"



gerade
straight

stainless steel



75620-15
15,5 cm, 6"

concave

Nagelzangen, Nagelspaltscheren
Nail Nippers, Nail splitting scissors
Alicates corta-uñas, Tijeras para hender uñas
Tronchesini per unghie, Forbici per staccare unghie

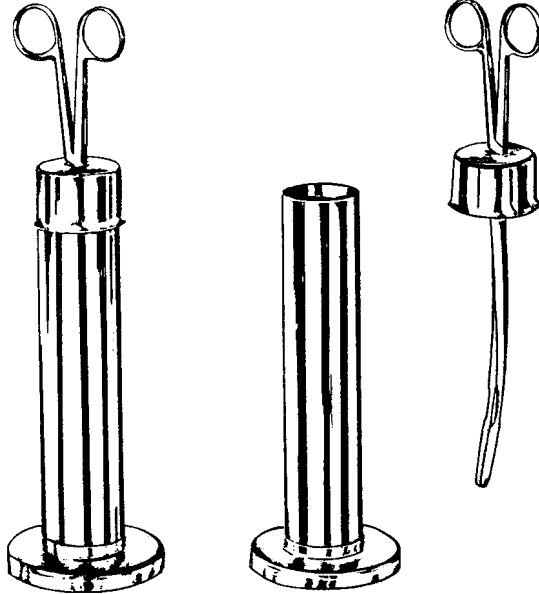


75630-12
12 cm, 4³/₄"



75640-15
15 cm, 6"

Kappenzangen, Nadel-Sterilisierkästen
 Sterilizing Forceps, Needle Sterilizing cases
 Combinacion tapa-pinza, Estuches para esterilizar agujas
 Pinza coperchio, Scatole per sterilizzare aghi



89111-25 25 cm, 10"
 89111-32 32 cm, 12^{3/4}"



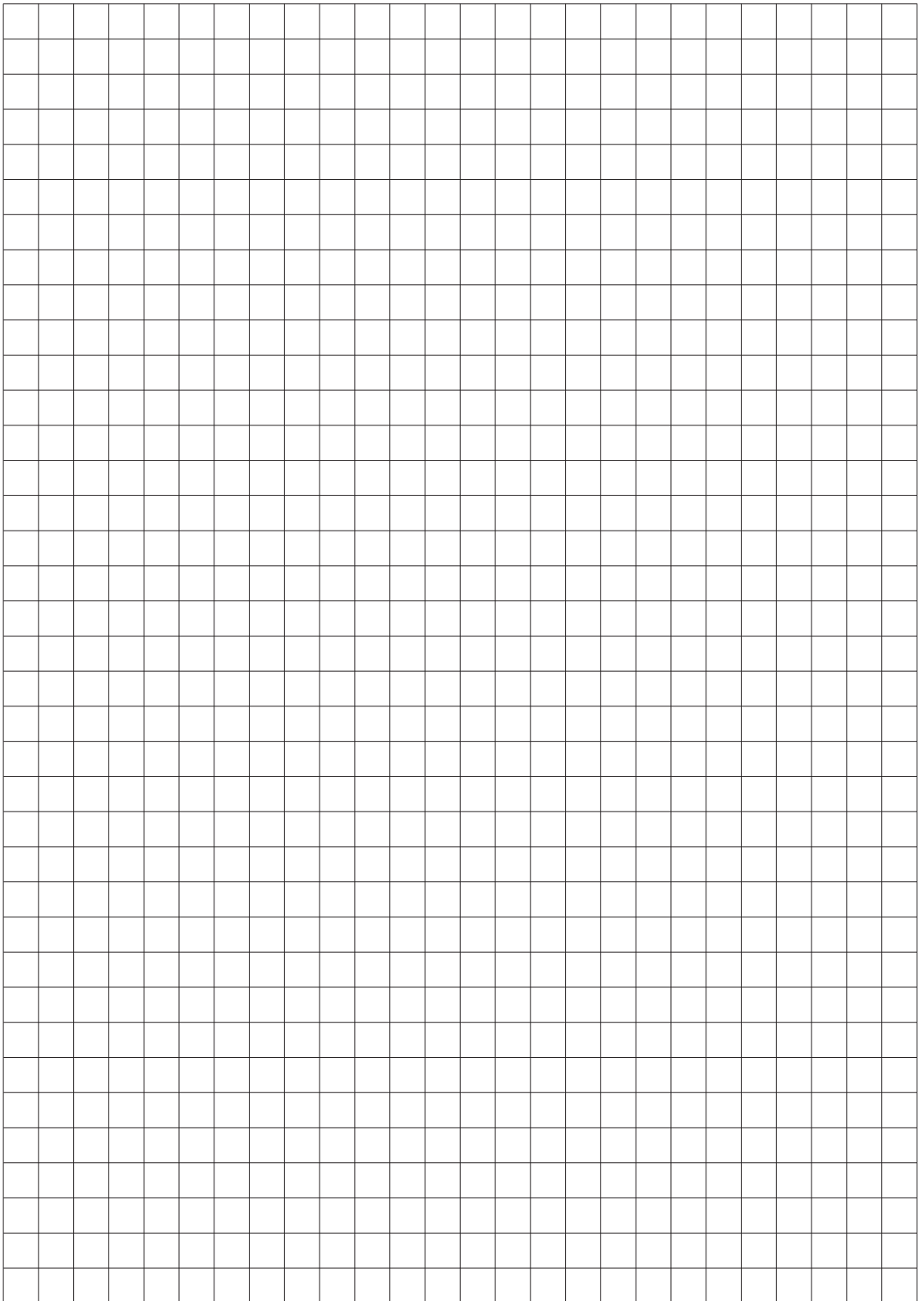
89112-65
 65 x 15 mm



89113-65



89114-00
 150 x 95 x 13 mm

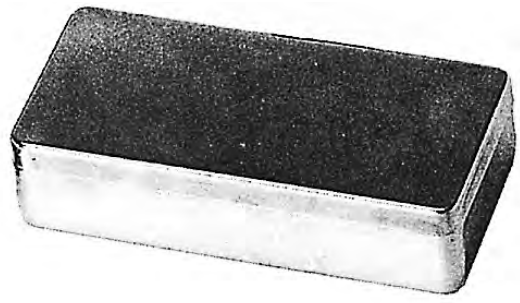


Instrumentenkästen
 Instrument Boxes
 Cajas para instrumentos
 Scatole per strumenti



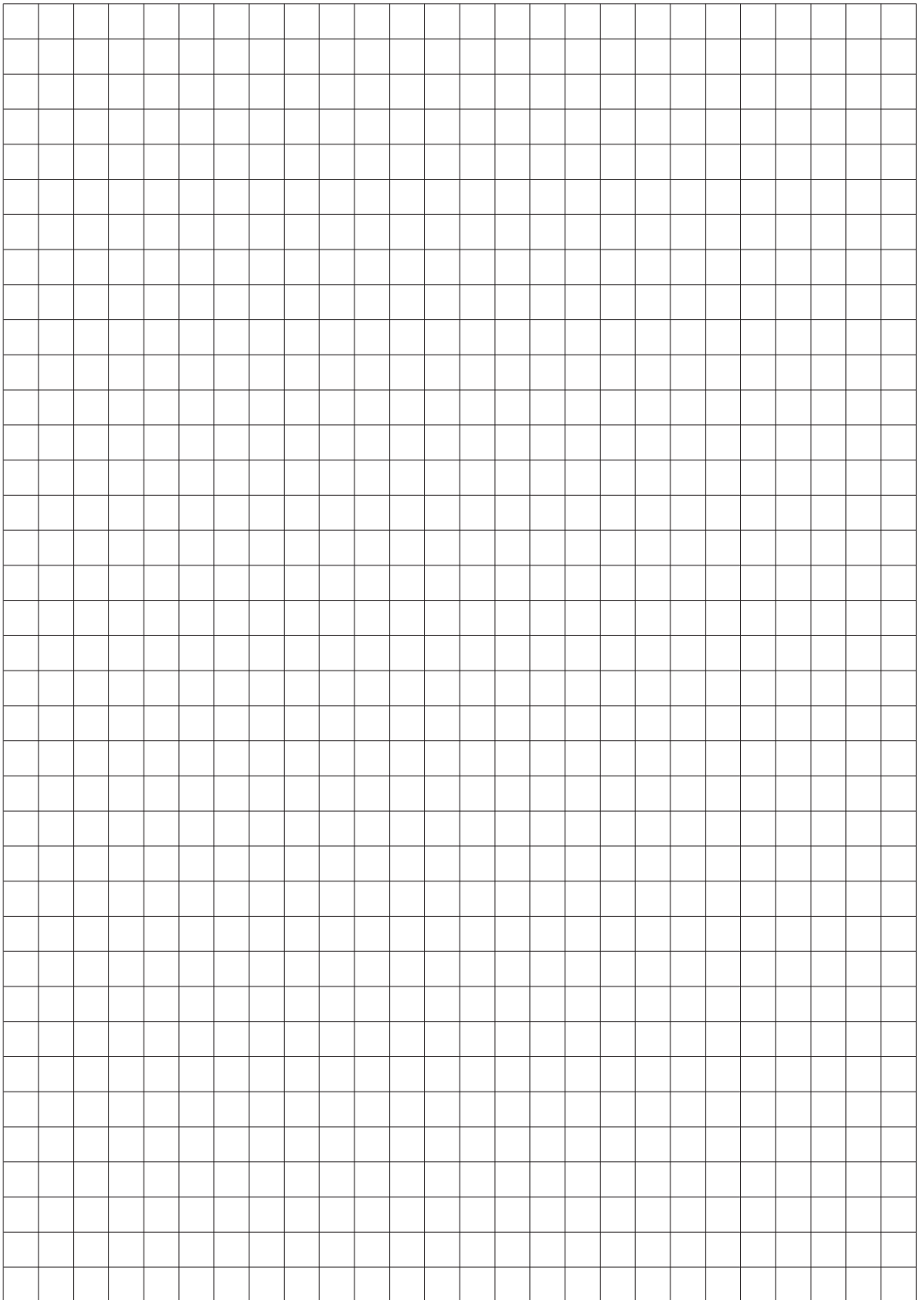
Abmessungen in mm
 Sizes in mm
 tamaños en mm
 misura in mm

I x b x h mm	
400x200x80	89121-40
500x270x70	89121-50



Abmessungen in mm Deckel ohne Knopf
 Sizes in mm lid without knob
 tamaños en mm tapa sin botón
 misura in mm coperchio senza bottone

I x b x h mm	
165x 85x35	89122-16
200x100x50	89122-21
260x150x50	89122-26
300x200x50	89122-30



Schüsseln
Bowls
Cubetas
Scodelle



18/10
Stainless Steel
Acero inoxidable
Acciaio inossidabile

matt
satin finish
pulidas mate
opaco



Abmessungen in mm sizes in mm Tamaños en mm misura in mm		Inhalt capacity capacidad capacità	
Ø x h	oz	l	
40 x 19	2	0,05	89127-04
61 x 30	3	0,07	89127-06
80 x 40	5	0,14	89127-08
116 x 50	12	0,35	89127-11
128 x 55	16	0,45	89127-12
147 x 65	25	0,70	89127-14
167 x 75	39	1,10	89127-16
187 x 85	57	1,60	89127-18

Abmessungen in mm sizes in mm Tamaños en mm misura in mm		Inhalt capacity capacidad capacità	
Ø x h	l		
100x30	0,15	89129-11	



	mm x mm	l
89133-16	165 x 60	0,75
89133-17	175 x 70	1,00
89133-22	220 x 80	2,00
89133-24	240 x 110	3,00
89133-31	310 x 120	6,00
89133-34	345 x 125	8,50
89133-38	380 x 130	11,00

89139-17	170 mm	0,25 l
89139-20	200 mm	0,35 l
89139-25	250 mm	0,5 l
89139-27	275 mm	0,75 l

Meßbecher, Dose, Standgefäß, Mehrzweckschalen
 Graduated Measures, Box, Jars, Universal Trays
 Copas graduadas, Recipientes, Tarros, Bandejas para instrumentos
 Bicchieri graduati, Recipienti, Recipienti cilindrici, Bacinelle per strumenti



l	
0,25	89140-02
0,5	89140-05
1,0	89140-10
2,0	89140-20



89141-10
100 x 20 mm

18/10
Stainless Steel
Acero inoxidable
Acciaio inossidabile

matt
satin finish
pulidas mate
opaco



	mmxmm
89142-01	30x 90
89142-02	50x100
89142-03	50x130
89142-04	50x175
89142-05	75x100
89142-06	75x130
89142-07	75x175



89147-21 - 89147-42

	l x b x h
89147-21	210x160x10 mm
89147-24	240x180x10 mm
89147-30	310x150x10 mm
89147-31	310x210x10 mm
89147-35	350x240x10 mm
89147-40	400x270x10 mm
89147-42	420x280x10 mm



89145-23 - 89145-40

	l x b x h
89145-23	230x155x30 mm
89145-30	300x175x30 mm
89145-31	300x175x40 mm
89145-35	350x240x36 mm

Wattedosen, Medizinlöffel, -becher
 Cotton wool containers, Medicine Spoon and Cups
 Distribuidores de algodón, Cuchara graduada, Vasos graduados
 Vaso portacotone, Cucchiaino per medicinali, bicchieri per medicinali



mit Deckel
 with Lid
 con tapa
 coperchio

	ø	h	l
89143-00	6 cm	6 cm	0,15 l
89143-01	8,5 cm	8,5 cm	0,4 l
89143-02	8,5 cm	12,5 cm	0,6 l
89143-03	8,5 cm	5 cm	0,25 l
89143-04	10 cm	10 cm	0,75 l
89143-05	10 cm	5 cm	0,35 l
89143-06	12 cm	12 cm	1,25 l
89143-07	15 cm	15 cm	2,5 l
89143-08	15 cm	10 cm	1,75 l
89143-10	20 cm	10 cm	3 l
89143-09	20 cm	20 cm	6 l



89146-20 20 cc
 110 x 20 mm



89147-10 100 cc
 89147-25 250 cc



89148-25 25 cc
 89148-50 50 cc

Stechbecken, Plazentabecken
Bed Pan, Placenta Pan
Silleta, Cubeta para placenta
Padella, bacinella per placenta



89148-32

89148-31
ø 310 mm89148-35
350 x 290 x 90 mm

Urinalschüssel
Urinal
Taza del orinal
Orinatoio

weiblich
female
mujer
femmina



89155-00
22 x13,5 cm
1 L

männlich
male
hombre
maschio



89156-00
1,4 L

Verbandstofftrommel, Sterilisiersiebkorb
 Sterilizing Drums, Sterilization Trays
 Tambores p. esterilización, Cestas de esterilización
 Tamburi p. sterilizzazione, Cestelli per erilizzazione



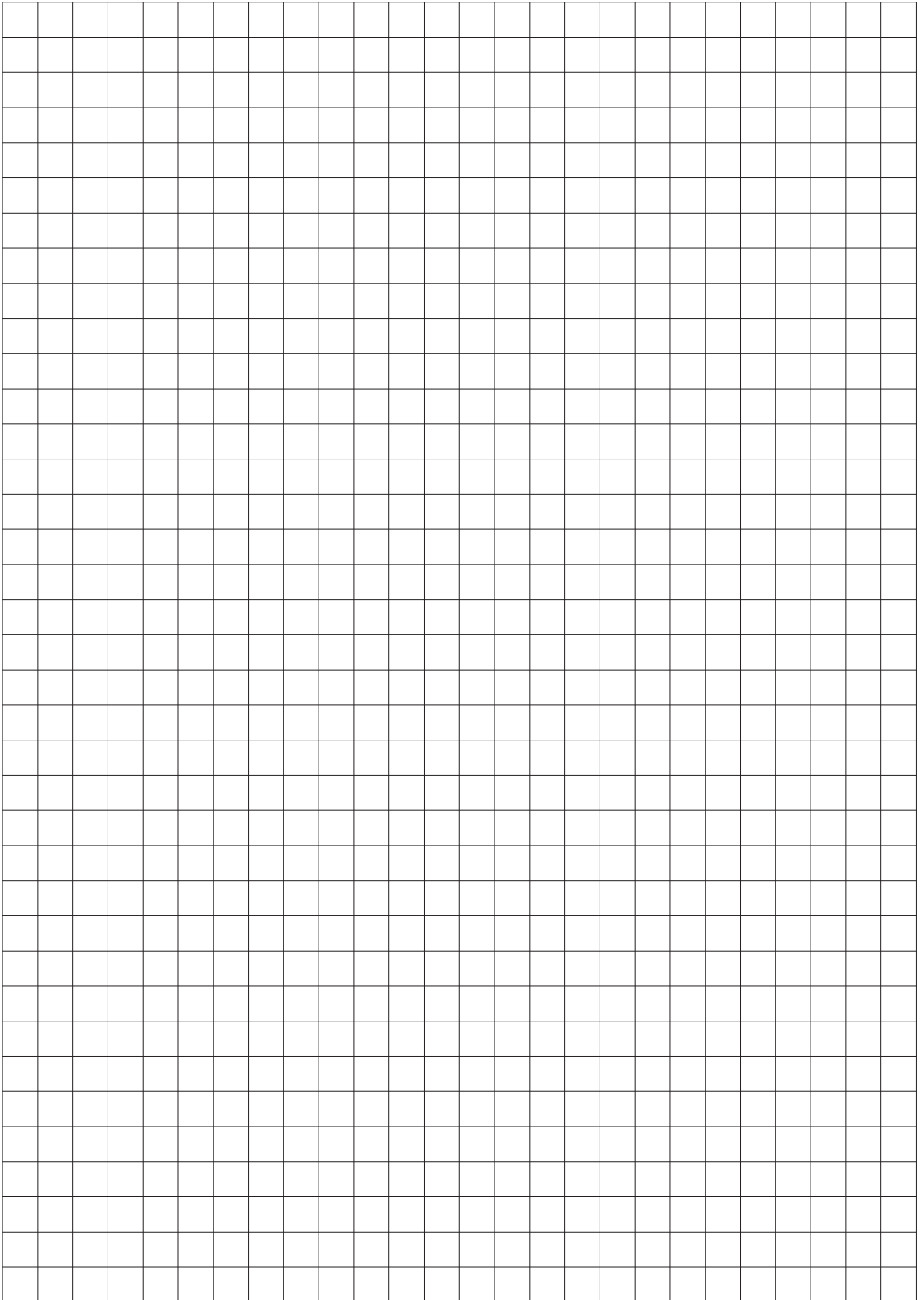
SCHIMMELBUSCH
 Ø
 mmxmm

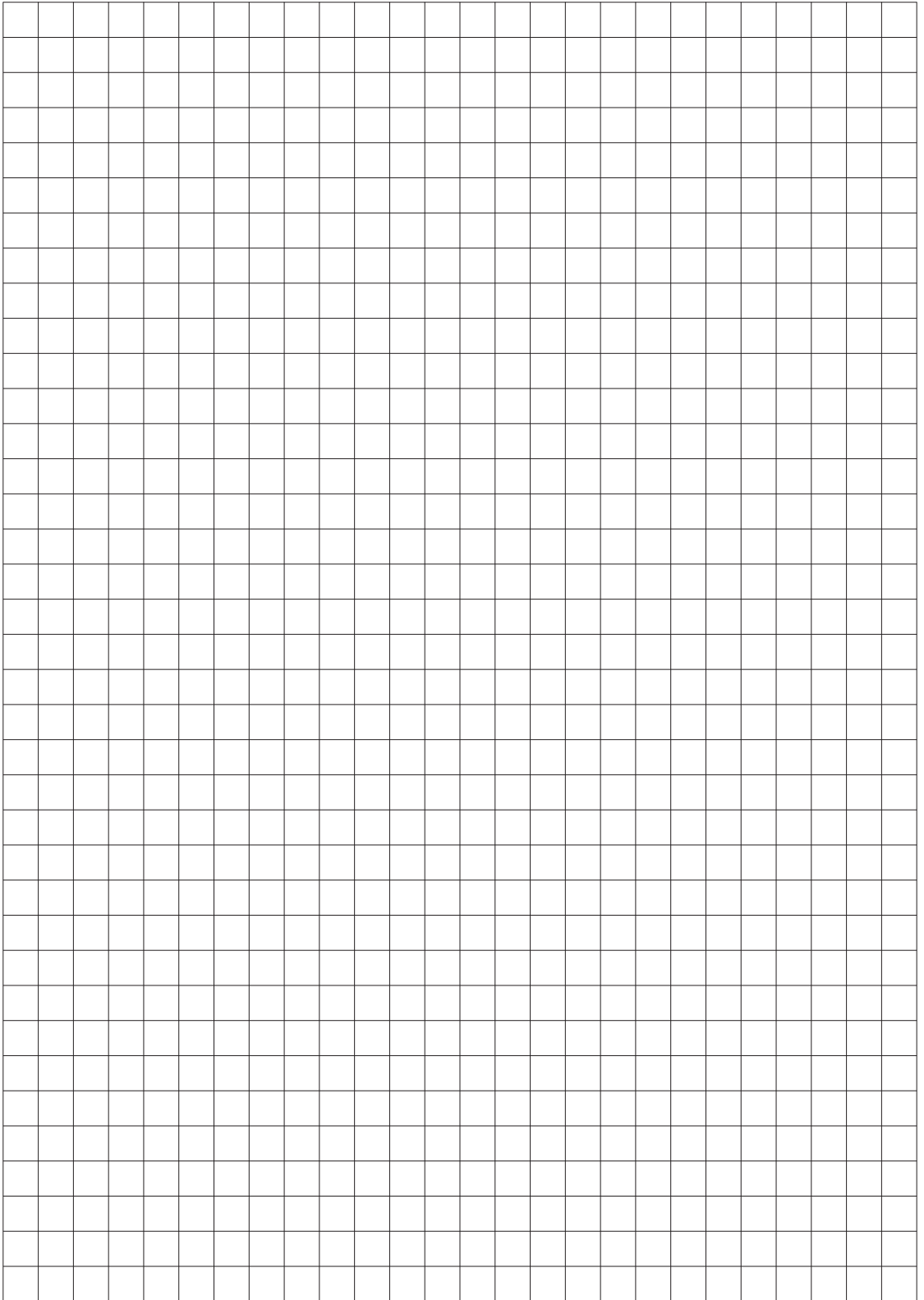
89152-08	125x 80
89152-10	125x100
89152-12	125x125
89155-08	150x 80
89155-10	150x100
89155-13	150x130
89155-15	150x150
89155-19	150x190
89159-14	190x145
89159-16	190x165
89159-19	190x190
89159-24	190x240
89164-14	240x145
89164-16	240x165
89164-19	240x190
89164-24	240x240
89164-29	240x290
89164-34	240x340
89164-39	240x390
89169-14	290x145
89169-16	290x165
89169-19	290x190
89169-24	290x240
89169-29	290x290
89169-34	290x340
89169-39	290x390
89174-14	340x145
89174-16	340x165
89174-19	340x190
89174-24	340x240
89174-29	340x290
89174-34	340x340
89174-39	340x390
89179-14	390x145
89179-16	390x165
89179-19	390x190
89179-24	390x240
89179-29	390x290
89179-34	390x340
89179-39	390x390
89179-49	390x490
89179-59	390x590

18/10
 Stainless Steel
 Acero inoxidable
 Acciaio inossidabile
 Acciaio inossidabile



R390.03	255x245x	30 mm
R390.05	255x245x	50 mm
R390.07	255x245x	70 mm
R390.10	255x245x	100 mm
R190.03	485x255x	30 mm
R190.05	485x255x	50 mm
R190.07	485x255x	70 mm
R190.10	485x255x	100 mm
R191.03	540x255x	30 mm
R191.05	540x255x	50 mm
R191.07	540x255x	70 mm
R191.10	540x255x	100 mm

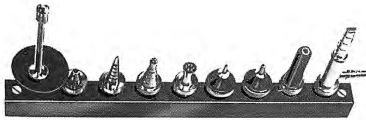


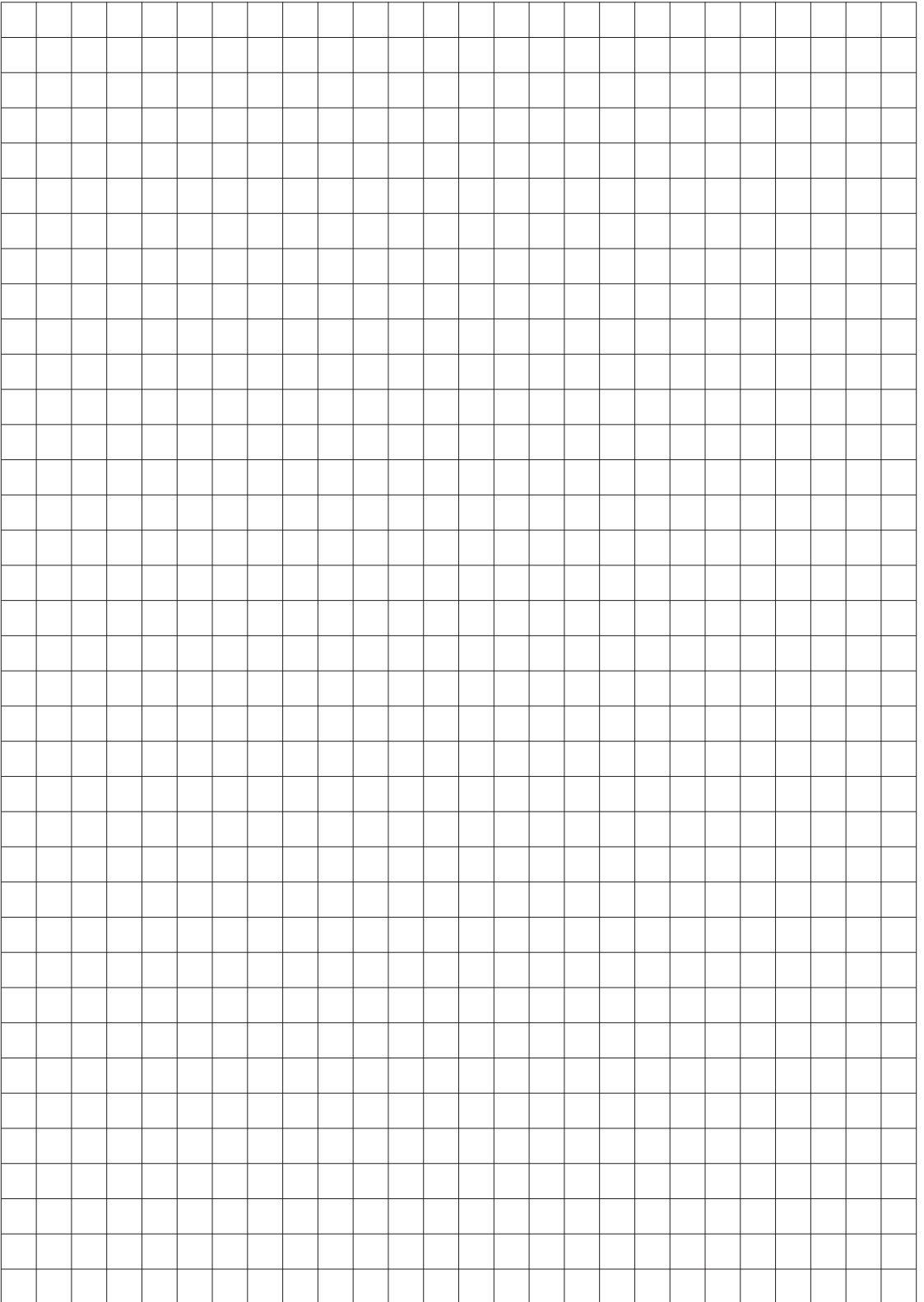


Reinigungspistole
Water Jet Pistol
Pistola-lavatora
Pistola lavatrice



89500-00
komplett mit 9 Aufsätzen
complete with 9 tips
con 9 toberas
completa con 9 raccordi





Hochfrequenz-Chirurgie
High Frequency Surgery
Electrocirugía
Elettrochirurgia

Mindestbestellmenge 10
Minimum order quantity 10
Cantidad minima 10
Minimo di quantitativo 10



Mindestbestellmenge 10
 Minimum order quantity 10
 Cantidad minima 10
 Minimo di quantitativo 10

Hochfrequenz-Chirurgie
 High Frequency Surgery
 Electrocirugía
 Elettrochirurgia



91011-51
 Fig. 51 45°
 Ø 3 mm



91011-52
 Fig. 52 45°
 7,0x1,7 mm



91011-53
 Fig. 53 45°



91011-54
 Fig. 54



91011-55
 Fig. 55



91011-56
 Fig. 56 45°
 Ø 5 mm



91011-61
 Fig. 61 45°



91011-62
 Fig. 62 90°

Schaft
 shaft
 vástago
 asta
 Ø 2,4 mm

Serie STANDARD



91020-01



91020-02

Schaft
 shaft
 vástago
 asta
 Ø 4 mm



91020-03



91020-04



Ø mm
 5 91022-05
 10 91022-10
 20 91022-20



Ø mm
 10 91024-10
 15 91024-15
 20 91024-20



Ø mm
 2 91030-02
 4 91030-04
 6 91030-06

Schaft
 shaft
 vástago
 asta
 Ø 4 mm

Bipolare Koagulation
 Bipolar Coagulation
 Coagulación bipolar
 Coagulazione bipolare

0,5 mm



11 cm, 4 3/8"	91102-11	
11 cm, 4 3/8"	91104-11	

0,5 mm



45°

fein
 fine
 fina
 fine

11 cm, 4 3/8"	91109-11	
---------------	----------	--

0,5 mm



45°

11 cm, 4 3/8"	91113-11	
11 cm, 4 3/8"	91115-11	




Bipolare Koagulation
 Bipolar Coagulation
 Coagulación bipolar
 Coagulazione bipolare








91123-16
 91127-16
 91157-19
 91159-19



91125-16











16,5 cm, 6 ½"	0,5 mm	91122-16	
16,5 cm, 6 ½"	1,0 mm	91124-16	
19,5 cm, 7 ¾"	0,3 mm	91152-19	
19,5 cm, 7 ¾"	1,0 mm	91154-19	


16,5 cm, 6 ½"	0,5 mm	91123-16	
16,5 cm, 6 ½"	0,5 mm	91125-16	
16,5 cm, 7 ¾"	1,0 mm	91127-16	
19,5 cm, 7 ¾"	1,0 mm	91157-19	
19,5 cm, 7 ¾"	2,0 mm	91159-19	

Bipolare Koagulation
 Bipolar Coagulation
 Coagulación bipolar
 Coagulazione bipolare



19,5 cm, 7 3/4"

16,5 cm, 6 1/2"	0,3 mm	91142-16	
16,5 cm, 6 1/2"	0,5 mm	91144-16	
16,5 cm, 7 3/4"	1,0 mm	91146-16	
16,5 cm, 7 3/4"	2,0 mm	91148-16	
19,5 cm, 7 3/4"	0,3 mm	91162-19	
19,5 cm, 7 3/4"	1,0 mm	91164-19	
19,5 cm, 7 3/4"	2,0 mm	91166-19	
22,5 cm, 9"	0,3 mm	91172-03	
22,5 cm, 9"	0,7 mm	91172-07	
22,5 cm, 9"	1,2 mm	91172-12	

1,0 mm	91167-19	91169-19	
	Abgewinkelt Angled down En ángulo hacia abajo Angolato in basso	Aufgewinkelt Angled up En ángulo hacia arriba Angolato verso l'alto	

Bipolare Koagulation
Bipolar Coagulation
Coagulación bipolar
Coagulazione bipolare

NON STICK

gerade
straight
recta
retta



	0,3 mm	0,5 mm	1,0 mm	2,0 mm
11,0 cm, 4 $\frac{3}{8}$ "	91110-03N	91110-05N	91110-10N	
16,0 cm, 6 $\frac{1}{4}$ "	91160-03N	91160-05N	91160-10N	91160-20N
18,0 cm, 7"		91180-05N	91180-10N	91180-20N
19,5 cm, 7 $\frac{3}{4}$ "		91200-05N	91200-10N	91200-20N
22,0 cm, 8 $\frac{3}{4}$ "			91220-10N	91220-20N
24,0 cm, 9 $\frac{1}{2}$ "			91240-10N	
30,0 cm, 12"			91300-10N	91300-20N

abgewinkelt 45°
angled 45°
angulada 45°
angolata 45°



	0,3 mm	0,5 mm	1,0 mm	2,0 mm
11,0 cm, 4 $\frac{3}{8}$ "	91112-03N	91112-05N	91112-10N	
16,0 cm, 6 $\frac{1}{4}$ "		91162-05N	91162-10N	
18,0 cm, 7"			91182-10N	91182-20N
19,5 cm, 7 $\frac{3}{4}$ "		91202-05N	91202-10N	91202-20N
22,0 cm, 8 $\frac{3}{4}$ "			91222-10N	91222-20N
24,0 cm, 9 $\frac{1}{2}$ "			91242-10N	
30,0 cm, 12"			91302-10N	

Bipolare Koagulation
Bipolar Coagulation
Coagulación bipolar
Coagulazione bipolare

NON STICK

bayonett gerade
bajonett straight
bayoneta recta
baionetta retta



	0,3 mm	0,5 mm	1,0 mm	2,0 mm
16,0 cm, 6¼"	91166-03N	91166-05N	91166-10N	91166-20N
19,5 cm, 7¾"		91206-05N	91206-10N	91206-20N
22,0 cm, 8¾"		91226-05N	91226-10N	91226-20N
24,0 cm, 9½"		91246-05N	91246-10N	91246-20N

bayonett nach oben
bajonett upwards
bayoneta hacia arriba
baionetta in alto



	1,0 mm
19,5 cm, 7¾"	91207-10N
22,0 cm, 8¾"	91227-10N

bayonett nach unten
bajonett downwards
bayoneta hacia abajo
baionetta in basso







	0,5 mm	1,0 mm
16,0 cm, 6¼"	91168-05N	91168-10N
19,5 cm, 7¾"		91208-10N
22,0 cm, 8¾"		91228-10N

Bipolare Verbindungskabel
Bipolar connecting cables
Cables de conexión bipolares
Cavi di collegamento bipolari

Bipolar

Geräte seite
Unit / Equipment side
Lado de la unidad/equipamiento
Unità / Lato equipaggiamento

Instrumentenseite
Instrument side
Lado de los instrumentos
Lato strumento

	Kabellänge Meter Cable length Meter Longitud del cable Medidor Misuratore della lunghezza del cavo	Europa-Flachstecker Europe flat plug El enchufe plano de Europa Spina piatta Europa
Erbe / Storz 12,5 mm Ø 	3	R065-040125-003
	5	R065-040125-005
Martin / Berchtold 8 mm Ø AESCULAP Wolf 	3	R065-020080-003
	5	R065-020080-005
Valleylab / Lamidey / EMC 	3	R065-040285-003
	5	R065-040285-005
2-Pin U.S. Standard Eschmann 	3	R065-040000-003
	5	R065-040000-005

Monopolare Pinzetten
 Monopolar Forceps
 Pinzas monopolares
 Pinze monopolare



ohne Buchse
 without socket
 sin casquillo
 senza presa



91800-18 18 cm, 7"
 91800-21 21 cm, 8 1/4"
 91800-25 25 cm, 10"

1 x 2 teeth



91900-18 18 cm, 7"
 91900-21 21 cm, 8 1/4"
 91900-25 25 cm, 10"



91801-18 18 cm, 7"
 91801-21 21 cm, 8 1/4"
 91801-25 25 cm, 10"

mit Buchse
 with socket
 con casquillo
 con presa



BiTech bipolare Scheren
 BiTech bipolar scissors
 Tijeras bipolares BiTech
 Forbici bipolari BiTech



91901-18 18 cm, 7"
 91901-23 23 cm, 8 1/4"
 91901-28 28 cm, 10"

Standard-Blatt
 Standard blade
 Hoja estándar
 Lama standard




91902-18 18 cm, 7"
 91902-23 23 cm, 8 1/4"
 91902-28 28 cm, 10"

Schlankes Blatt
 Delicate blade
 Hoja delgada
 Lama sottile



Rundstecker
 Round plug
 Connecteur rond
 Enchufe redondo

 2-Pin U.S. Standard Eschmann	3 m	91999-43
	5 m	91999-45

Instrumentenöl
 Instrument oil
 Oleo para instrumentos
 Olio per strumenti

INSTRU CARE ist ein Instrumentenpflegeöl auf der Basis von hochreinen medizinischen Weißölen zum Erhalt der Funktionsfähigkeit und Werterhaltung von chirurgischen Instrumenten. Die Anwendung erfolgt nach der Reinigung bzw. vor dem Sterilisationsvorgang.

INSTRU CARE is an instrument oil for care and protection of surgical instruments and guaranties the function and protects the value of instruments. It will be used after cleansing and before sterilization process.

INSTRU CARE olio para instrumentos

INSTRU CARE è un olio estremamente puro per la lubrificazione e la pulizia dello strumentario chirurgico. Privo di silicone, appropriato per la sterilizzazione a vapore e ad aria calda. Fisiologicamente inerte con utilizzo prima della sterilizzazione.



98000-01
 100ml

Kunststoff-Flasche
 plastic bottle
 botella
 bottiglia

03

03112-51 5
03112-52 5
03112-53 5
03114-57 6
03114-58 6
03114-59 6
03133-00 12
03133-01 12
03161-00 13
03161-01 14
03161-02 15
03161-03C 16
03167-03 20
03171-00 17
03171-01 17
03171-02 17
03180-90 21
03180-92 21
03180-93 21
03195-00 22
03195-01 22
03195-06 22
03195-07 22
03195-08 22
03246-00 23
03246-01 23
03246-02 23
03248-00 23
03260-15 23
03262-18 23
03288-17 24
03288-20 24
03292-22 24
03294-24 24
03304-20 24
03306-17 24
03308-18 24
03310-01 25
03310-02 25
03312-01 25
03314-01 25
03320-19 25
03340-10 25
03340-15 25
03340-20 25
03340-30 25
03340-50 25
03360-21 26
03361-10 26

05

05130-05 27
05130-10 27
05140-05 27
05140-08 27
05150-21 27
05150-27 27
05150-48 27
05151-01 27
05151-02 27
05160-02 28
05160-03 28
05160-04 28
05170-24 28
05180-32 28
05190-17 28
05190-20 28
05190-25 28

05203-00 30
05204-00 30
05210-00 30/1
05210-01 30/1
05210-02 30/1
05210-03 30/1
05210-04 30/1
05211-00 29/1
05211-01 29/1
05211-02 29/1
05211-03 29/1
05211-04 29/1
05212-03 29
05212-04 29
05213-03 30/2
05213-03CL 29/2
05213-04 30/2
05213-04CL 29/2
05230-00 30/3
05230-00CL 29/3
05230-01 30/3
05230-01CL 29/3
05230-02 30/3
05230-02CL 29/3
05230-03 30/3
05230-03CL 29/3
05230-04 30/3
05230-04CL 29/3
05233-18 33
05234-28 33
05238-02 32
05238-03 32
05238-12 32
05238-13 32
05239-01 31
05239-02 31
05239-03 32
05239-19 32
05239-30 32
05241-01 34
05241-02 34
05241-11 33
05241-12 33
05300-01 36
05300-02 36
05300-03 36
05300-04 36
05300-05 36
05301-01 35
05301-02 35
05301-03 35
05301-04 35
05301-05 35
05301-06 35
05301-07 35
05302-01 36
05302-02 36
05302-03 36
05303-01 36
05304-01 36
05305-01 37
05305-02 37

07

07102-00 38
07103-00 38
07103-01 38
07103-02 38
07104-00 39
07104-02 39

07105-02 39
07106-01 39/1
07106-02 39/1
07107-00 39/2
07107-01 39/2
07107-03 39/2
07107-04 39/2
07108-00 40
07109-03 40
07109-10 41
07109-13 41
07109-15 41
07110-00 42
07111-00 42
07112-00 42
07113-00 42
07115-00 42
07116-00 42
07118-00 42
07119-00 42
07120-00 42
07121-00 42
07122-00 42
07123-00 42
07124-00 42
07125-00 42
07130-00 42
07161-00 41
07162-00 41
07165-00 41
07167-00 41
07200-17 44
07200-20 44
07201-13 44
07201-16 44
07201-19 44
07201-22 44
07202-12 44
07203-16 44
07203-19 44
07203-22 44
07204-11 44
07205-09 44
07290-09 45
07291-11 45
07294-13 45
07296-00 45/50
07402-01 46
07402-02 46
07402-03 46
07402-04 46
07402-05 46
07402-06 46
07402-07 46
07402-08 46
07402-09 46
07403-01 47
07403-02 47
07410-05 47
07412-05 47
07420-08 48
07421-09 48
07422-19 48
07423-16 48
07423-20 48
07423-24 48
07424-11 48
07424-14 48
07424-17 48
07425-11 48

09

07490-00 49
07490-01 49
07490-02 49
07495-31 50
07496-31 50
07498-00 50
07499-00 50
07499-01 50

09102-11 51
09102-13 51
09102-14 51
09102-15 51
09102-16 51
09102-18 51
09102-20 51
09103-11 51
09103-13 51
09103-14 51
09103-15 51
09103-16 51
09103-18 51
09103-20 51
09104-14 51
09105-14 51
09110-11 51
09110-13 51
09110-14 51
09110-15 51
09110-16 51
09110-18 51
09110-20 51
09111-11 51
09111-13 51
09111-14 51
09111-15 51
09111-16 51
09111-18 51
09111-20 51
09114-14 51
09115-14 51
09120-11 51
09120-13 51
09120-15 51
09120-16 51
09120-18 51
09120-20 51
09121-11 51
09121-13 51
09121-14 51
09121-15 51
09121-16 51
09121-18 51
09121-20 51
09124-14 51
09125-14 51
09128-14 52
09130-14 52
09131-14 52
09140-14 52
09141-14 52
09150-14 52
09151-14 52
09160-14 52/1
09160-17 52/1
09160-19 52/1
09160-23 52/1
09160-28 52/1

09161-14 52/1
09161-17 52/1
09161-19 52/1
09161-23 52/1
09161-28 52/1
09164-14 52/1
09164-17 52/1
09164-23 52/1
09165-14 52/1
09165-17 52/1
09165-23 52/1
09170-15 52/1
09170-17 52/1
09170-21 52/1
09171-15 52/1
09171-17 52/1
09171-21 52/1
09174-15 52/1
09174-17 52/1
09174-21 52/1
09175-15 52/1
09175-17 52/1
09175-21 52/1
09180-17 52/1
09181-17 52/1
09190-16 53
09191-16 53
09194-16 53
09195-16 53
09202-10 53
09203-10 53
09204-22 53
09206-10 53
09207-10 53
09280-12 53/1
09280-15 53/1
09280-18 53/1
09280-20 53/1
09280-23 53/1
09280-25 53/1
09280-28 53/1
09280-30 53/1
09281-12 53/1
09281-15 53/1
09281-15B 53/3
09281-18 53/1
09281-18B 53/3
09281-20 53/1
09281-20B 53/3
09281-23 53/1
09281-25 53/1
09281-28 53/1
09281-30 53/1
09282-15 53/1
09282-18 53/1
09282-20 53/1
09282-23 53/1
09282-25 53/1
09282-28 53/1
09283-15 53/1
09283-18 53/1
09283-18B 53/3
09283-20 53/1
09283-20B 53/3
09283-23 53/1
09283-25 53/1
09283-28 53/1
09284-12 53/1
09284-15 53/1
09284-18 53/1
09284-20 53/1

09284-23	53/1	09354-10	57	09513-20	62	09905-14	69/1	10028-14	73
09284-25	53/1	09355-10	57	09513-23	62	09905-18	69/1	10029-14	73
09284-28	53/1	09356-10	57	09514-20	62	09906-18	69/1	10030-18	73
09284-30	53/1	09357-10	57	09514-23	62	09906-20	69/1	10031-18	73
09285-12	53/1	09358-11	56	09516-23	62	09911-23	69/1	10032-23	73
09285-15	53/1	09360-11	58	09517-23	62	09913-20	69/2	10033-23	73
09285-15W	53/4	09361-11	58	09523-24	62	09913-22	69/2	10034-14	73
09285-18	53/1	09362-11	58	09525-22	63	09915-23	69/2	10035-14	73
09285-18W	53/4	09363-11	58	09530-17	63	09921-16	69/2	10036-18	73
09285-20	53/1	09370-11	58	09531-17	63	09921-19	69/2	10037-18	73
09285-20W	53/4	09371-11	58	09536-27	63	09930-14	70	10038-23	73
09285-23	53/1	09374-11	58	09537-27	63	09931-14	70	10039-23	73
09285-25	53/1	09375-11	58	09540-16	61	09933-23	70	10040-18	74
09285-28	53/1	09381-11	58	09541-16	61	09935-23	70	10042-18	74
09285-30	53/1	09401-18	58	09542-16	61	09937-23	70	10044-14	74
09286-15	53/1	09403-15	58	09543-16	61	09939-23	70	10045-14	74
09286-18	53/1	09405-16	59	09548-18	64	09941-20	70	10046-14	74
09286-20	53/1	09406-16	59	09550-10	64	09950-15	70	10047-14	74
09286-23	53/1	09425-17	59	09551-16	64	09950-18	70	10048-14	74
09286-25	53/1	09427-17	59	09553-16	64	09960-14	71	10049-14	74
09286-28	53/1	09435-18	59	09560-14	64	09961-14	71	10102-11	75
09287-15	53/1	09437-19	59	09560-22	64	09962-14	71	10104-11	75
09287-18	53/1	09439-17	59	09580-11	65	09962-17	71	10110-12	75
09287-20	53/1	09470-11	59	09581-11	65	09962-23	71	10111-12	75
09287-23	53/1	09473-21	59	09582-15	65	09963-14	71	10113-11	75
09287-25	53/1	09475-00	60	09583-15	65	09963-17	71	10115-11	75
09287-28	53/1	09475-25	60	09601-22	65	09963-23	71	10117-11	75
09289-28	53/2	09475-45	60	09610-18	65	09964-15	71	10119-10	75
09290-25	53/2	09475-60	60	09611-18	65	09964-17	71	10120-16	76
09291-18	54	09475-90	60	09613-20	65/1	09965-15	71	10120-18	76
09291-20	54	09476-00	60	09614-19	65/1	09965-17	71	10120-22	76
09291-23	54	09476-25	60	09617-13	65/1	09966-11	71	10121-16	76
09295-18	54	09476-45	60	09619-17	65/1	09967-11	71	10121-18	76
09295-20	54	09476-60	60	09641-30	65/2	09970-14	71	10121-22	76
09295-23	54	09476-90	60	09643-19	65/2	09970-18	71	10123-16	76
09296-15	54	09477-01	60	09643-25	65/2	09970-20	71	10123-18	76
09296-18	54	09478-25	60	09651-24	65/2	09970-23	71	10123-22	76
09296-23	54	09478-45	60	09661-23	65/2	09971-14	71	10126-00	77
09302-14	54/1	09478-60	60	09770-18	66	09971-18	71	10126-25	77
09303-14	54/1	09479-25	60	09772-21	66	09971-20	71	10126-45	77
09304-14	54/1	09479-45	60	09774-21	66	09971-23	71	10126-60	77
09305-14	54/1	09479-60	60	09775-13	66	09980-11	72	10126-90	77
09310-12	54/1	09480-25	61	09777-13	66	09981-11	72	10127-00	77
09310-15	54/1	09480-40	61	09802-09	66	09982-12	72	10127-25	77
09312-12	54/1	09480-60	61	09802-11	66	09983-12	72	10127-45	77
09314-12	54/1	09481-25	61	09803-09	66	09984-11	72	10127-60	77
09320-15	54/1	09481-40	61	09803-13	66	09985-11	72	10127-90	77
09321-15	54/1	09481-60	61	09804-14	66	09990-14	72	10128-09	78
09321-18	54/1	09490-16	61	09809-15	66	09990-18	72	10128-15	78
09325-15	54/1	09490-23	61	09820-13	67	09993-15	72	10129-15	78
09340-09	54/2	09490-28	61	09821-13	67	09993-18	72	10130-15	78
09340-10	54/2	09491-16	61	09823-12	67	09995-12	72	10131-14	78
09340-11	54/2	09491-23	61	09824-12	67			10131-18	78
09341-09	54/2	09491-28	61	09825-12	67			10133-10	79
09341-10	54/2	09492-16	61	09826-12	67			10135-10	79
09341-11	54/2	09492-23	61	09827-12	67			10137-01	78
09344-11	54/2	09492-28	61	09828-12	67	10010-19	73	10137-02	78
09345-11	54/2	09496-15	61	09829-12	67	10011-19	73	10140-08	79
09346-11	54/2	09497-15	61	09831-12	67	10012-19	73	10141-08	79
09348-01	55	09505-23	63	09835-12	67	10013-19	73	10141-08	79
09348-02	55	09505-26	63	09850-10	68	10014-19	73	10142-08	79
09348-03	55	09505-30	63	09851-10	68	10015-19	73	10143-08	79
09348-04	55	09507-23	63	09854-11	69	10018-20	73	10151-11	79
09348-05	55	09507-26	63	09859-16	69	10019-20	73	10153-11	79
09348-06	55	09507-30	63	09860-16	69	10020-17	73	10155-11	79
09349-12	55	09510-20	62	09898-20	69/1	10021-17	73	10202-18	80
09350-09	57	09510-23	62	09901-09	69/1	10022-20	73	10203-18	80
09350-10	56	09511-20	62	09901-11	69/1	10023-20	73	10313-14	80
09351-09	57	09511-23	62	09901-14	69/1	10024-17	73	10313-16	80
09352-09	57	09512-20	62	09901-18	69/1	10025-17	73	10320-09	80
09353-09	57	09512-23	62	09901-20	69/1	10026-20	73	10330-19	80
						10027-20	73	10331-19	80

10333-19 80

11

11102-10 81
 11102-11 81
 11102-13 81
 11102-14 81
 11102-16 81
 11102-18 81
 11102-20 81
 11102-25 81
 11102-30 81
 11103-14 81
 11104-12 81
 11104-13 81
 11104-14 81
 11104-15 81
 11104-18 81
 11104-21 81
 11104-25 81
 11106-13 81
 11106-15 81
 11110-11 81
 11110-13 81
 11110-14 81
 11110-16 81
 11110-18 81
 11110-20 81
 11110-25 81
 11110-30 81
 11112-18 81
 11112-21 81
 11112-25 81
 11114-14 81
 11114-16 81
 11114-20 81
 11114-25 81
 11116-18 81
 11116-21 81
 11116-25 81
 11120-10 81/1
 11120-11 81/1
 11120-13 81/1
 11120-14 81/1
 11120-16 81/1
 11120-18 81/1
 11120-20 81/1
 11120-25 81/1
 11120-30 81/1
 11122-12 81/1
 11122-13 81/1
 11122-14 81/1
 11122-15 81/1
 11122-18 81/1
 11122-21 81/1
 11122-25 81/1
 11124-15 81/1
 11126-18 81
 11126-21 81
 11126-25 81
 11130-11 81/1
 11130-13 81/1
 11130-14 81/1
 11130-16 81/1
 11130-18 81/1
 11130-20 81/1
 11132-16 81/1
 11132-18 81/1
 11132-20 81/1
 11132-25 81/1

11140-11 81/1
 11140-13 81/1
 11140-14 81/1
 11140-16 81/1
 11140-18 81/1
 11140-20 81/1
 11140-25 81/1
 11150-13 81/1
 11150-14 81/1
 11150-16 81/1
 11160-13 81/1
 11160-14 81/1
 11160-16 81/1
 11170-12 81/2
 11170-12G 81/2
 11170-15 81/2
 11170-18 81/2
 11174-12 81/2
 11174-15 81/2
 11176-12 81/2
 11176-15 81/2
 11177-12 81/2
 11178-12 81/2
 11179-12 81/2
 11180-12 82
 11180-15 82
 11180-18 82
 11181-12 82
 11181-12M 82
 11181-15 82
 11186-12 82
 11186-15 82
 11187-12 82
 11187-18 83
 11187-20 83
 11187-25 83
 11187-30 83
 11188-12 82
 11188-15 82
 11189-12 82
 11189-15 83
 11189-20 83
 11189-25 83
 11190-10 83
 11220-17 83
 11221-17 83
 11222-17 83
 11223-17 83
 11224-17 83
 11225-17 83
 11231-20 83
 11232-15 84
 11233-20 84
 11234-20 84
 11235-20 84
 11236-15 84
 11236-20 84
 11237-20 84
 11240-14 84
 11242-14 84
 11246-18 85
 11248-18 85
 11250-14 85
 11252-20 85
 11256-15 85
 11256-20 85
 11256-25 85
 11257-15 85
 11258-15 85
 11259-15 85
 11259-18 85

11259-20 85
 11259-23 85
 11260-12 86
 11260-15 86
 11261-15 86
 11270-12 86
 11270-15 86
 11271-15 86
 11271-18 86
 11272-15 86
 11273-15 86
 11274-06 86
 11274-08 86
 11274-10 86
 11302-17 86
 11302-23 86
 11303-17 86
 11304-17 86
 11305-17 87
 11310-17 87
 11311-17 87
 11312-17 87
 11312-18 87
 11313-17 87
 11314-01 87
 11314-02 87
 11315-01 87
 11315-02 87
 11316-14 88
 11316-16 88
 11316-20 88
 11317-00 88
 11317-12 88
 11317-23 88
 11318-18 88
 11318-20 88
 11318-25 88
 11319-12 88
 11319-14 88
 11320-18 88
 11320-23 88
 11322-15 89
 11322-18 89
 11322-23 89
 11323-19 89
 11324-23 89
 11325-15 89
 11325-23 89
 11325-25 89
 11326-23 89
 11328-15 89
 11328-20 89
 11401-01 90
 11403-03 90
 11403-04 90
 11404-04 90
 11405-05 90
 11407-07 90
 11802-09 91
 11802-10 91
 11802-11 91
 11810-07 91
 11810-09 91
 11810-11 91
 11812-10 91
 11813-10 91
 11816-10 91
 11817-10 91
 11821-11 92
 11822-13 92
 11823-13 92

11824-14 92
 11825-14 92
 11828-15 92
 11900-01 93
 11901-05 93
 11910-01 93

12

12102-12 94
 12103-12 94
 12104-15 94
 12105-15 94
 12108-18 94
 12109-18 94
 12110-15 95
 12110-20 95
 12110-24 95
 12110-30 95
 12200-16 96
 12201-16 96
 12291-22 97
 12293-22 97
 12295-22 97
 12297-22 97
 12302-16 98
 12302-20 98
 12302-24 98
 12304-16 98
 12304-20 98
 12304-24 98
 12304-30 98
 12306-16 98
 12306-20 98
 12306-24 98
 12306-30 98
 12308-16 98
 12308-20 98
 12308-24 98
 12308-30 98
 12309-16 98
 12309-20 98
 12309-24 98
 12309-30 98
 12310-16 98
 12310-20 98
 12310-24 98
 12310-30 98
 12320-15 99
 12320-20 99
 12320-24 99
 12325-16 99
 12325-20 99
 12325-24 99
 12330-16 99
 12330-20 99
 12330-24 99
 12330-30 99
 12340-16 99
 12340-20 99
 12340-24 99

13

13001-08 101
 13001-10 101
 13001-12 101
 13002-08 101
 13002-10 101
 13002-12 101
 13005-10 101
 13005-14 101

13005-20 101
 13006-10 101
 13006-14 101
 13006-20 101
 13010-30 102
 13010-35 102
 13010-40 102
 13010-50 102
 13011-30 102
 13011-35 102
 13011-40 102
 13011-50 102
 13012-30 102
 13012-35 102
 13012-40 102
 13012-50 102
 13013-30 102
 13013-35 102
 13013-40 102
 13013-50 102
 13014-30 102
 13014-35 102
 13014-40 102
 13014-50 102
 13015-30 102
 13015-35 102
 13015-40 102
 13015-50 102
 13090-40 100
 13090-45 100
 13090-50 100
 13091-40 100
 13091-45 100
 13091-50 100
 13092-07 103
 13092-08 103
 13092-10 103
 13092-12 103
 13093-07 103
 13093-08 103
 13093-10 103
 13093-12 103
 13094-07 100
 13094-11 100
 13095-01 100
 13095-02 100
 13096-06 103
 13096-07 103
 13096-09 103
 13096-11 103
 13097-06 103
 13097-07 103
 13097-09 103
 13097-11 103
 13098-06 100
 13099-07 100
 13102-04 104
 13102-05 104
 13103-04 104
 13103-05 104
 13110-50 104
 13110-55 104
 13110-65 104
 13110-70 104
 13110-75 104
 13110-90 104
 13111-50 104
 13111-55 104
 13111-65 104
 13111-70 104
 13111-75 104

13111-90	104	13310-30	108	13381-15	111	13441-04	117	13565-20	123/2
13115-00	104	13311-13	108	13382-15	111	13442-21	117	13565-25	123/2
13210-10	104	13311-14	108	13383-15	111	13442-26	117	13570-23	124
13211-10	104	13311-16	108	13384-20	112	13443-21	117	13571-25	124
13212-10	104	13311-18	108	13384-24	112	13443-26	117	13573-22	124
13213-10	104	13311-20	108	13384-26	112	13444-21	117	13574-24	125
13214-10	104	13311-22	108	13385-20	112	13444-26	117	13575-25	125
13215-10	104	13311-24	108	13385-24	112	13445-21	117	13579-21	125
13220-12	105	13311-26	108	13385-26	112	13445-26	117	13580-60	126
13220-14	105	13311-30	108	13386-20	112	13447-20	117	13580-80	126
13220-18	105	13312-14	108	13386-24	112	13448-22	117	13591-20	126
13220-21	105	13312-16	108	13386-26	112	13449-22	117	13591-23	126
13221-12	105	13313-14	108	13387-20	112	13450-24	118	13593-20	126
13221-14	105	13313-16	108	13387-24	112	13451-24	118	13593-23	126
13221-18	105	13320-13	108	13387-26	112	13453-18	118	13595-10	127
13221-21	105	13320-14	108	13390-20	112	13453-24	118	13595-20	127
13222-12	105	13320-16	108	13391-20	112	13455-01	118	13595-30	127
13223-12	105	13320-18	108	13391-23	112	13455-02	118	13595-40	127
13224-12	105	13320-20	108	13393-20	112	13456-01	119	13597-10	127
13225-12	105	13320-22	108	13394-20	112	13456-02	119	13597-20	127
13226-12	105	13320-24	108	13395-20	112	13456-03	119	13597-30	127
13227-12	105	13320-26	108	13410-18	112	13457-28	119	13597-40	127
13228-13	106	13320-30	108	13411-18	112	13459-18	119	13598-24	126
13230-12	105	13321-13	108	13412-18	113	13459-28	119	13599-24	126
13230-14	105	13321-14	108	13413-18	113	13471-14	119/1	13600-20	127
13230-18	105	13321-16	108	13414-20	113	13471-16	119/1	13601-20	127
13230-21	105	13321-18	108	13415-14	113	13471-18	119/1	13605-26	128
13231-12	105	13321-20	108	13415-18	113	13471-23	119/1	13610-21	128/1
13231-14	105	13321-22	108	13416-18	113	13473-22	119/1	13611-21	128/1
13231-18	105	13321-24	108	13420-14	114	13474-19	119/1	13612-21	128/1
13231-21	105	13321-26	108	13421-01	114	13474-24	119/1	13613-21	128/1
13232-12	105	13321-30	108	13421-02	114	13474-26	119/1	13620-24	128/1
13233-12	105	13322-14	108	13421-03	114	13475-14	119/1	13620-26	128/1
13240-14	106	13322-16	108	13421-04	114	13475-18	119/1	13620-30	128/1
13240-18	106	13323-14	108	13421-05	114	13477-15	119/2	13621-24	128/1
13241-14	106	13323-16	108	13421-06	114	13477-19	119/2	13621-26	128/1
13241-18	106	13330-13	109	13421-07	114	13479-22	119/2	13621-30	128/1
13242-16	106	13330-15	109	13422-00	114	13479-25	119/2	13622-24	128/1
13243-16	106	13330-18	109	13422-01	114	13479-28	119/2	13622-26	128/1
13244-14	106	13330-20	109	13422-02	114	13480-15	119/2	13622-30	128/1
13245-14	106	13330-23	109	13422-03	114	13480-18	119/2	13623-24	128/1
13250-14	107	13331-13	109	13422-06	114	13481-15	119/2	13623-26	128/1
13250-18	107	13331-15	109	13423-01	114	13481-18	119/2	13623-30	128/1
13251-14	107	13331-18	109	13423-02	114	13491-19	119/2	13640-28	128/2
13251-18	107	13331-20	109	13423-03	114	13493-23	120	13702-14	129
13254-14	107	13331-23	109	13423-04	114	13495-18	120	13704-16	129
13255-14	107	13340-16	109	13423-05	114	13497-20	120	13704-18	129
13256-14	106	13340-20	109	13425-02	114	13499-16	120	13710-15	129
13257-14	106	13341-16	109	13425-03	114	13501-23	120	13710-19	129
13258-16	106	13341-20	109	13425-04	114	13503-21	121	13710-20	129
13259-16	106	13345-12	109	13425-05	114	13505-21	121	13712-15	129
13260-14	107	13345-14	109	13425-06	114	13507-22	121	13712-18	129
13261-14	107	13350-16	109	13428-21	115	13507-23	121	13712-20	129
13262-16	107	13350-20	109	13431-13	115	13513-23	122	13720-18	130
13263-16	107	13351-16	109	13431-16	115	13515-23	122		
13264-16	107	13351-20	109	13431-18	115	13517-23	122		
13265-16	107	13356-15	109	13431-20	115	13519-20	122		
13266-16	107	13358-15	109	13431-23	115	13519-22	122		
13267-16	107	13358-20	109	13431-25	115	13519-24	122		
13268-16	107	13360-15	110	13431-28	115	13520-23	122		
13269-16	107	13364-14	110	13432-19	116	13520-24	122		
13270-14	106	13366-19	110	13433-19	116	13523-23	123		
13271-14	106	13368-14	110	13434-28	116	13551-14	123		
13310-13	108	13368-16	110	13435-28	116	13551-18	123		
13310-14	108	13370-13	110	13438-01	116	13551-20	123		
13310-16	108	13372-13	110	13438-02	116	13554-21	123		
13310-18	108	13374-14	110	13438-03	116	13555-21	123		
13310-20	108	13376-16	110	13438-04	116	13556-24	123		
13310-22	108	13377-25	111	13441-01	117	13561-20	123		
13310-24	108	13377-26	111	13441-02	117	13563-20	123		
13310-26	108	13380-15	111	13441-03	117	13564-20	123/1		

15101-09	132
15103-07	132
15103-09	132
15105-09	132
15107-10	132
15107-13	132
15108-14	132
15111-09	132
15111-11	132
15111-13	132
15111-15	132
15115-11	132
15117-13	132
15121-11	133

15121-13 133
 15123-11 133
 15123-13 133
 15124-13 133
 15125-14 133
 15140-16 133
 15161-18 133
 15164-15 133
 15164-20 133

17

17110-20 134
 17110-25 134
 17110-27 134
 17111-20 134
 17111-25 134
 17111-27 134
 17112-20 134
 17112-25 134
 17113-20 134
 17113-25 134
 17120-28 134
 17121-28 134
 17131-21 134
 17133-17 135
 17160-22 135
 17160-25 135
 17161-22 135
 17161-25 135
 17170-18 136
 17170-20 136
 17170-25 136
 17170-30 136
 17171-18 136
 17171-20 136
 17171-25 136
 17172-18 136
 17172-25 136
 17173-18 136
 17173-25 136
 17174-25 136
 17175-25 136
 17180-18 136
 17180-25 136
 17207-13 137
 17210-13 137
 17210-16 137
 17210-18 137
 17220-25 137
 17226-25 137
 17227-25 137
 17229-25 137
 17230-26 138
 17231-26 138
 17233-26 138

19

19102-12 139
 19102-15 139
 19104-15 139
 19110-13 139
 19110-18 139
 19120-00 139
 19120-14 139
 19120-15 139
 19120-17 139
 19122-13 140
 19123-11 140
 19124-15 140

19125-14 140
 19126-13 140
 19127-11 140
 19131-21 141
 19132-15 141
 19134-20 141
 19135-19 141
 19136-20 141
 19137-16 141
 19140-00 142
 19140-01 142
 19140-02 142
 19150-01 142
 19150-02 142
 19150-03 142
 19150-04 142
 19152-25 142
 19152-31 142
 19152-38 142
 19152-51 142
 19152-64 142
 19158-51 142
 19158-64 142
 19158-76 142
 19158-82 142
 19159-50 142
 19159-64 142
 19159-70 142
 19159-90 142
 19160-17 143
 19161-17 143
 19162-10 143
 19162-13 143
 19168-06 143/1
 19168-08 143/1
 19168-10 143/1
 19168-12 143/1
 19168-17 143/1
 19168-20 143/1
 19168-25 143/1
 19169-25 143/1
 19170-20 143/1
 19170-25 143/1
 19170-32 143/1
 19170-40 143/1
 19170-45 143/1
 19170-50 143/1
 19170-65 143/1
 19170-76 143/1
 19171-30 143/2
 19171-40 143/2
 19171-50 143/2
 19171-60 143/2
 19171-70 143/2
 19172-30 143/3
 19173-20 143/3
 19173-30 143/3
 19173-40 143/3
 19174-17 143/3
 19174-25 143/3
 19174-37 143/3
 19174-40 143/3
 19175-28 143/3
 19176-25 143/4
 19177-27 143/4
 19178-28 143/4
 19179-28 144
 19180-19 145
 19181-22 145
 19181-25 145
 19183-25 145

19185-25 145
 19187-25 145
 19187-38 146
 19187-50 146
 19187-75 146
 19189-25 146
 19189-38 146
 19189-50 146
 19189-75 146
 19190-64 147
 19191-25 147
 19191-40 147
 19191-62 147
 19192-23 147
 19195-01 148
 19195-02 148
 19195-03 148
 19196-01 148/1
 19196-02 148/1
 19196-03 148/1
 19196-04 148/1
 19196-05 148/1
 19196-06 148/1
 19210-12 148/2
 19211-12 148/2
 19212-01 148/2
 19212-02 148/2
 19213-01 148/3
 19213-02 148/3
 19213-03 148/3
 19213-04 148/3
 19213-05 148/3
 19213-06 148/3
 19213-07 148/3
 19213-08 148/3
 19213-09 148/3
 19213-10 148/3
 19213-11 148/3
 19213-13 148/3
 19214-04 148/4
 19214-13 148/2
 19214-15 148/4
 19214-16 148/4
 19214-18 148/2
 19214-20 148/4
 19214-25 148/4
 19214-30 148/4
 19215-01 149
 19215-02 149
 19215-03 149
 19215-05 148/5
 19215-06 148/5
 19215-07 148/5
 19215-13 148/2
 19215-14 148/5
 19215-15 148/5
 19215-16 148/5
 19215-18 148/2
 19216-01 149
 19216-02 149
 19216-05 149
 19216-07 149
 19216-10 149
 19217-03 149
 19217-05 149
 19217-07 149
 19220-01 150
 19220-02 150
 19220-03 150
 19220-04 150
 19221-01 150

19221-02 150
 19221-03 150
 19221-04 150
 19226-02 150
 19226-03 150
 19226-04 150
 19227-02 150
 19227-03 150
 19227-04 150
 19229-02 150
 19229-03 150
 19230-10 151
 19230-12 151
 19230-14 151
 19230-16 151
 19230-18 151
 19231-11 151
 19231-13 151
 19231-15 151
 19232-08 151
 19232-10 151
 19232-12 151
 19232-14 151
 19232-16 151
 19232-18 151
 19233-08 152
 19233-11 152
 19233-15 152
 19233-17 152
 19233-20 152
 19233-23 152
 19234-20 153
 19235-21 153
 19236-01 153
 19236-02 153
 19236-08 152
 19236-10 152
 19236-12 152
 19236-14 152
 19236-16 152
 19236-18 152
 19240-10 153
 19240-20 153
 19250-16 153
 19250-24 153
 19270-02 153
 19270-03 153
 19270-04 153
 19270-06 153
 19271-02 153
 19271-03 153
 19271-04 153
 19271-06 153
 19280-01 154
 19280-02 154
 19280-03 154
 19280-04 154
 19280-06 154
 19281-01 154
 19281-02 154
 19281-03 154
 19281-04 154
 19281-06 154
 19282-02 154
 19282-03 154
 19282-04 154
 19282-06 154
 19296-01 155
 19296-02 155
 19296-03 155
 19296-04 155

19296-06 155
 19296-08 155
 19297-01 155
 19297-02 155
 19297-03 155
 19297-04 155
 19297-06 155
 19297-08 155
 19298-01 156
 19299-01 156
 19302-01 157
 19302-02 157
 19302-03 157
 19302-04 157
 19302-05 157
 19302-06 157
 19304-19 157
 19306-20 157
 19307-01 157
 19307-02 157
 19310-01 158
 19310-02 158
 19310-03 158
 19310-04 158
 19310-05 158
 19312-01 158
 19312-02 158
 19312-03 158
 19312-04 158
 19312-05 158
 19314-07 159
 19314-10 159
 19314-12 159
 19314-14 159
 19314-15 159
 19314-16 159
 19314-20 159
 19315-06 159
 19315-21 159
 19317-21 159
 19318-40 159
 19318-57 159
 19318-78 159
 19330-40 158
 19330-55 158
 19332-19 160
 19332-21 160
 19340-10 160
 19340-15 160
 19340-20 160
 19344-14 160
 19344-20 160
 19344-26 160
 19345-01 160
 19345-02 160
 19345-03 160
 19348-22 160
 19350-35 161
 19350-60 161
 19350-70 161
 19360-04 162
 19364-40 162
 19364-50 162
 19364-60 162
 19364-70 162
 19366-08 162
 19367-08 162
 19370-40 163
 19370-50 163
 19370-60 163
 19370-75 163

19370-85	163	19670-20	169	19738-65	179	19802-16	189/1	19980-02	197
19372-22	163	19670-24	169	19744-00	180	19802-18	189/1	19980-03	197
19374-45	163	19671-14	169	19744-17	180	19803-14	189/1	19980-04	197
19374-55	163	19671-16	169	19745-40	180	19804-18	189/2	19980-05	197
19374-65	163	19671-20	169	19745-45	180	19805-18	189/2	19980-06	197
19378-25	163	19671-24	169	19745-50	180	19805-28	189/2	19980-18	198
19380-35	163	19672-11	171	19745-55	180	19806-18	189/2	19990-18	198
19380-50	163	19673-11	171	19745-60	180	19810-22	190	19995-22	198
19381-50	163	19674-15	170	19745-65	180	19812-60	190	19995-38	198
19382-50	163	19675-00	171	19745-70	180	19813-00	191	19998-03	198
19383-50	163	19675-13	171	19748-01	180	19813-01	191	19998-05	198
19385-38	164	19676-00	170	19748-02	180	19813-21	191		
19385-57	164	19677-13	171	19748-03	180	19813-22	191		
19388-40	164	19677-19	170	19748-04	180	19815-50	191		
19388-50	164	19677-25	170	19754-00	181	19815-60	191	21102-11	199
19388-65	164	19677-32	170	19758-85	181	19815-72	191	21102-13	199
19400-01	165	19678-05	170	19759-00	181	19816-00	191	21102-14	199
19400-02	165	19678-06	170	19760-14	181	19820-02	193/195	21102-16	199
19400-03	165	19678-16	171	19762-16	181	19820-03	193/195	21102-18	199
19480-22	164	19679-20	172	19764-18	182	19820-10	193/195	21102-20	199
19480-27	164	19679-22	172	19764-20	182	19820-20	193/194	21102-25	199
19482-45	164	19680-19	172	19764-25	182	19820-90	192/193	21104-11	199
19482-73	164	19681-19	172	19765-01	183	19820-91	192/193	21104-13	199
19482-82	164	19681-21	172	19765-02	183	19820-99	193	21104-14	199
19484-01	164	19682-26	173	19765-03	183	19821-01	193/195	21104-16	199
19484-02	164	19683-26	173	19765-04	183	19821-02	193/195	21104-18	199
19490-22	166	19684-14	173	19766-90	182	19821-03	193/195	21104-20	199
19490-43	166	19684-16	173	19767-01	184	19821-04	193/195	21104-25	199
19490-65	166	19684-20	173	19767-02	184	19822-01	193	21106-11	199
19492-25	164	19684-26	173	19767-03	184	19822-02	193	21106-13	199
19493-80	167	19685-14	173	19767-18	184	19822-21	194	21106-14	199
19494-00	167	19685-16	173	19767-25	184	19822-22	194	21106-16	199
19494-12	167	19685-20	173	19770-01	187	19822-22L	194	21106-18	199
19494-13	167	19685-26	173	19770-02	187	19822-23	193	21106-20	199
19494-14	167	19686-32	174	19770-03	187	19822-24	193	21106-25	199
19494-16	167	19687-01	175	19770-04	187	19822-25	193/194	21108-14	199
19494-18	167	19687-02	175	19770-05	187	19822-26	193/194	21109-18	199
19494-45	166	19688-01	175	19771-00	185	19824-06	193/194	21110-13	199
19494-60	166	19688-02	175	19771-01	185	19825-06	193/194	21110-14	199
19494-75	166	19689-01	175/1	19771-02	185	19826-06	193/194	21110-16	199
19495-60	167	19689-02	175/1	19771-03	185	19831-25	193/194	21110-18	199
19495-80	167	19690-31	176	19772-00	185	19833-33	193/194	21110-20	199
19496-00	167	19692-32	176	19772-03	185	19834-01	193/194	21111-14	199
19496-12	167	19694-01	177	19780-01	187	19901-00	267	21112-14	199
19496-14	167	19694-02	177	19781-55	186	19902-10	267	21120-16	199
19496-50	166	19694-03	177	19781-65	186	19903-00	267	21121-14	199
19496-90	166	19696-18	178	19782-00	186	19910-00	196	21121-18	199
19497-14	167	19698-18	178	19783-01	187	19911-00	196	21122-13	199
19498-01	167	19710-00	178/1	19783-24	186	19912-50	196	21122-18	199
19498-02	167	19710-01	178/1, 178/2	19784-00	187/1	19912-70	196	21125-01	200
19498-03	167	19710-40	178/1, 178/3	19784-30	187/1	19913-50	196	21125-02	200
19498-07	168	19710-45	178/1, 178/3	19784-40	187/1	19913-70	196	21125-03	200
19611-07	168	19710-50	178/1, 178/3	19784-50	187/1	19914-41	196	21125-04	200
19620-07	168	19710-55	178/1, 178/3	19784-60	187/1	19914-67	196	21150-00	201
19620-10	168	19710-60	178/1, 178/3	19784-78	187/1	19915-48	196	21150-02	201
19621-07	168	19711-00	178/3	19784-80	187/1	19915-64	196	21150-03	201
19621-10	168	19711-01	178/3, 178/4	19784-98	187/1	19916-64	196	21150-06	201
19630-10	168	19711-40	178/2, 178/4	19784-99	187/1	19916-80	196	21150-09	201
19631-10	168	19711-45	178/2, 178/4	19790-01	187	19917-64	196	21150-12	201
19634-10	168	19711-50	178/2, 178/4	19790-02	187	19918-64	196	21150-15	201
19635-10	168	19711-55	178/2, 178/4	19795-01	188	19918-88	196	21150-80	201
19636-14	168	19711-60	178/2, 178/4	19795-02	188	19960-01	197	21150-90	201
19637-14	168	19712-00	178/2	19798-02	188	19960-02	197	21154-01	202
19640-14	169	19713-00	178/4	19799-05	188	19960-03	197	21154-02	202
19641-14	169	19721-00	179	19800-01	189/1	19960-04	197	21154-03	202
19650-10	169	19721-15	179	19800-02	189/1	19960-05	197	21154-04	202
19651-10	169	19726-01	179	19800-03	189/1	19960-06	197	21154-05	202
19654-13	169	19738-45	179	19800-04	189/1	19970-01	198	21154-06	202
19655-13	169	19738-50	179	19800-09	189/1	19970-23	198	21160-04	202
19670-14	169	19738-55	179	19802-11	189/1	19970-24	198	21160-06	202
19670-16	169	19738-60	179	19802-14	189/1	19980-01	197	21160-07	202

21160-08	202
21160-10	202
21160-12	202
21160-14	202
21162-12	202
21190-14	203
21270-12	203
21270-14	203
21270-16	203
21270-18	203
21270-23	203
21270-30	203
21272-12	203
21272-14	203
21272-16	203
21272-18	203
21272-23	203
21290-12	203
21290-14	203
21290-16	203
21290-18	203
21292-12	203
21292-14	203
21292-16	203
21292-18	203
21310-15	203
21320-12	203
21320-18	203
21331-25	203

23

23104-00	204
23110-30	204
23110-35	204
23110-40	204
23110-45	204
23110-50	204
23110-55	204
23110-60	204
23123-30	204
23123-40	204
23125-11	204
23128-19	204
23140-02	204
23150-10	205
23150-12	205
23150-14	205
23150-16	205
23150-18	205
23150-20	205
23170-25	205
23170-30	205
23170-33	205
23170-35	205
23181-40	205
23195-08	207
23195-10	207
23195-12	207
23195-14	207
23195-16	207
23195-18	207
23197-08	207
23197-10	207
23197-12	207
23197-14	207
23197-16	207
23197-18	207
23198-08	207
23198-10	207
23198-12	207

23198-14	207
23198-16	207
23198-18	207
23210-00	206
23302-01	206
23302-02	206
23302-03	206
23302-04	206
23302-05	206
23302-06	206
23302-07	206
23302-08	206
23310-14	206
23310-18	206

25

25110-12	208
25114-12	208
25120-12	208
25122-12	208
25128-13	208
25129-13	208
25130-13	208
25134-13	208
25136-11	208
25137-11	208
25138-11	208
25140-13	208
25144-13	208
25146-13	208
25148-13	208
25150-12	208
25150-14	208
25154-12	208
25154-14	208
25160-15	209
25160-18	209
25160-20	209
25160-23	209
25164-15	209
25164-18	209
25164-20	209
25164-23	209
25170-15	209
25174-15	209
25180-12	209
25180-14	209
25180-16	209
25180-18	209
25180-20	209
25180-24	209
25180-26	209
25180-30	209
25184-12	209
25184-14	209
25184-16	209
25184-18	209
25184-20	209
25184-24	209
25184-26	209
25184-30	209
25190-16	209
25190-18	209
25190-20	209
25194-16	209
25194-18	209
25194-20	209
25196-13	209
25196-18	209
25214-16	210

25214-18	210
25214-20	210
25214-23	210
25214-26	210
25214-31	210
25224-13	210
25224-15	210
25224-18	210
25224-20	210
25224-23	210
25224-26	210
25225-13	210
25225-15	210
25225-18	210
25225-20	210
25225-23	210
25225-26	210
25230-18	210
25230-20	210
25230-23	210
25241-21	210
25241-26	210
25245-21	210
25245-26	210
25250-27	210
25254-27	210
25260-27	210
25264-27	210
25285-20	211
25285-24	211
25285-26	211
25290-18	211
25292-18	211
25311-20	211
25311-27	211
25315-20	211
25315-27	211
25324-18	211
25324-26	211
25330-21	212
25330-23	212
25334-23	212
25405-12	212
25406-12	212
25407-12	212
25408-12	212
25410-14	212
25410-17	212
25414-14	212
25414-17	212
25414-18	212
25415-14	212
25415-17	212
25415-20	212
25430-16	212
25434-11	212
25434-13	212
25434-16	212
25436-13	212
25438-13	212
25438-15	213
25446-25	213
25447-25	213
25450-14	213
25450-17	213
25450-20	213
25450-24	213
25452-14	213
25452-17	213
25452-20	213
25452-24	213

25460-18	213
25460-20	213
25460-23	213
25610-11	214
25612-15	214
25614-12	214
25615-12	214
25620-16	214
25621-16	214
25624-16	214
25625-16	214
25627-14	214
25628-14	214
25650-10	216
25651-10	216
25656-10	216
25657-10	216
25660-13	217
25661-13	217
25667-18	215
25667-21	215
25668-18	215
25668-21	215
25670-14	215
25671-14	215
25672-14	215
25673-14	215
25676-14	215
25677-14	215
25678-09	215
25678-14	216
25679-09	215
25679-14	216
25680-13	215
25684-13	215
25700-18	217
25701-18	217
25720-14	217
25721-14	217
25722-14	217
25723-14	217
25730-18	217
25731-18	217

27

27109-20	218
27110-21	218
27110-24	218
27110-27	218
27111-21	218
27111-24	218
27111-27	218
27120-21	218
27120-24	218
27120-27	218
27121-21	218
27121-24	218
27121-27	218
27130-13	219
27131-13	219
27134-32	219
27139-19	219
27201-15	220
27201-19	220
27201-21	220
27202-15	220
27202-19	220
27202-21	220
27203-15	220
27203-19	220

27203-21	220
27204-15	220
27204-19	220
27204-21	220
27271-19	221
27277-25	221
27285-20	221/1
27288-22	221/1
27289-22	221/1
27291-18	221/1
27291-27	221/1
27297-23	221/1
27298-23	221/1
27403-01	222
27403-02	222
27403-03	222
27403-04	222
27403-05	222
27403-06	222
27403-07	222
27403-08	222
27403-09	222
27403-10	222
27403-11	222
27403-12	222
27403-13	222
27403-14	222
27403-15	222
27403-16	222
27413-01	222
27413-02	222
27413-03	222
27413-04	222
27413-05	222
27413-06	222
27413-07	222
27413-08	222
27413-09	222
27413-10	222
27413-11	222
27413-12	222
27413-13	222
27413-14	222
27413-15	222
27413-16	222
27423-01	222
27423-02	222
27423-03	222
27423-04	222
27423-05	222
27423-06	222
27423-07	222
27423-08	222
27423-09	222
27423-10	222
27423-11	222
27423-12	222
27423-13	222
27423-14	222
27423-15	222
27423-16	222
27433-01	222
27433-02	222
27433-03	222
27433-04	222
27433-05	222
27433-06	222
27433-07	222
27433-08	222
27433-09	222
27433-10	222

27433-11	222	27487-02	223	31205-09	230/16	33157-05	238	33380-17	244
27433-12	222	27487-03	223	31210-10	230/6	33157-06	238	33380-21	244
27433-13	222	27487-04	223	31210-21	230/10	33158-03	238	33380-24	244
27433-14	222	27487-05	223	31210-22	230/10	33158-04	238	33382-33	244
27433-15	222	27610-12	224	31210-30	230/18	33158-05	238	33382-45	244
27433-16	222	27612-12	224	31210-45	230/14	33201-18	238	33384-33	244
27434-01	222	27614-12	224	31210-50	230/14	33202-18	238	33384-45	244
27434-02	222	27620-18	224	31210-65	230/14	33205-18	238	33391-15	245
27434-03	222	27630-12	224	31211-45	230/14	33211-15	238	33391-19	245
27434-04	222	27640-13	224	31211-50	230/14	33213-15	238	33391-24	245
27434-05	222	27642-14	224	31211-65	230/14	33216-18	239	33391-26	245
27434-06	222			31212-02	230/18	33217-18	239	33391-28	245
27434-07	222			31212-50	230/14	33219-23	239	33395-17	245
27434-08	222			31212-65	230/14	33220-20	239	33395-25	245
27434-09	222			31220-99	230/18	33230-22	239	33395-26	245
27434-10	222			31250-00	231	33230-26	239	33395-27	245
27434-11	222			31250-10	231/1	33231-22	239	33402-17	246
27434-12	222			31250-12	231/1	33231-26	239	33404-20	246
27434-13	222			31250-20	231/1	33235-23	239	33405-20	246
27434-14	222			31250-14	231/1	33237-23	239	33406-20	246
27434-15	222			31250-15	231/1	33241-30	240	33407-13	246
27434-16	222			31252-11	231	33243-30	240	33407-19	246
27441-01	223			31252-22	231	33245-23	240	33409-13	246
27441-02	223			31253-00	231	33247-23	240	33410-19	246
27441-03	223			31253-11	231	33251-26	240	33412-16	247
27441-04	223			31254-10	231	33253-26	240	33412-24	247
27441-05	223			31254-11	231	33257-23	240	33413-14	247
27441-06	223			31254-12	231	33258-23	240	33414-21	247
27441-07	223			31350-28	232	33259-23	240	33415-23	248
27441-08	223			31360-30	232	33260-24	240	33415-25	248
27441-09	223			31362-28	232	33261-22	240	33415-28	248
27441-10	223			31366-23	232	33274-14	241	33416-17	248
27441-11	223			31370-20	233	33274-17	241	33417-18	248
27441-12	223			31380-18	233	33274-19	241	33418-17	248
27443-01	223			31390-18	233	33274-22	241	33419-20	248
27443-02	223			31395-18	233	33275-14	241	33420-20	249
27443-03	223			31397-24	233	33275-17	241	33421-20	249
27443-04	223					33275-19	241	33423-23	249
27443-05	223					33275-22	241	33424-10	249
27443-10	223					33280-15	241	33441-13	249
27443-20	223					33281-15	241	33441-18	249
27443-30	223					33282-19	241	33441-20	249
27450-01	223					33283-17	241	33443-18	249
27450-02	223					33284-15	241	33444-15	250
27450-03	223					33286-18	241	33450-01	250
27450-04	223					33289-18	241	33450-02	250
27450-05	223					33290-23	242	33467-97	251
27450-06	223					33290-27	242	33467-98	251
27452-01	223					33291-23	242	33468-00	251
27452-02	223					33291-27	242	33468-01	251
27452-03	223					33292-26	242	33468-02	251
27452-04	223					33293-27	242	33468-03	251
27452-05	223					33295-24	242	33468-04	251
27452-06	223					33360-21	243	33469-96	251
27465-10	223					33362-21	243	33469-97	251
27465-20	223					33365-19	243	33469-98	251
27467-01	223					33366-19	243	33470-00	251
27467-02	223					33366-23	243	33470-01	251
27467-03	223					33366-26	243	33470-02	251
27467-04	223					33368-26	243	33470-03	251
27467-05	223					33370-22	244	33470-04	251
27475-10	223					33370-27	244	33470-05	251
27475-20	223					33370-30	244	33470-06	251
27477-01	223					33372-22	244	33471-96	251
27477-02	223					33372-26	244	33471-97	251
27477-03	223					33372-33	244	33471-98	251
27477-04	223					33378-15	244	33472-00	251
27477-05	223					33378-17	244	33472-01	251
27485-10	223					33378-21	244	33472-02	251
27485-20	223					33380-11	244	33472-03	251
27487-01	223					33380-15	244	33472-04	251

29**31****33**

33472-05	251	33486-00	255	33604-08	259	33631-30	260	33651-18	261
33472-06	251	33486-01	255	33604-10	259	33632-06	260	33651-20	261
33473-01	252	33486-02	255	33604-12	259	33632-08	260	33651-25	261
33473-02	252	33486-99	255	33604-14	259	33632-10	260	33651-30	261
33473-03	252	33487-00	255	33604-16	259	33632-12	260	33651-38	261
33473-04	252	33487-01	255	33605-04	259	33632-15	260	33651-44	261
33473-05	252	33487-02	255	33605-06	259	33632-20	260	33651-50	261
33473-06	252	33487-99	255	33605-08	259	33632-25	260	33652-02	262
33474-96	251	33488-00	255	33605-10	259	33632-30	260	33652-03	262
33474-97	251	33488-01	255	33605-12	259	33633-06	260	33652-04	262
33474-98	251	33488-02	255	33605-14	259	33633-08	260	33652-06	262
33475-00	251	33489-00	255	33605-16	259	33633-10	260	33652-08	262
33475-01	251	33489-01	255	33610-04	259	33633-12	260	33652-10	262
33475-02	251	33489-02	255	33610-06	259	33633-15	260	33652-12	262
33475-03	251	33489-03	255	33610-08	259	33633-20	260	33652-15	262
33475-04	251	33490-10	256	33610-10	259	33633-25	260	33654-02	262
33475-05	251	33490-20	256	33610-12	259	33633-30	260	33654-03	262
33475-06	251	33490-30	256	33610-14	259	33634-06	260	33654-04	262
33476-01	253	33490-40	256	33611-04	259	33634-08	260	33654-06	262
33476-02	253	33490-50	256	33611-06	259	33634-10	260	33654-08	262
33476-03	253	33491-01	256	33611-08	259	33634-12	260	33654-10	262
33476-98	253	33491-02	256	33611-10	259	33634-15	260	33654-12	262
33476-99	253	33491-03	256	33611-12	259	33634-20	260	33654-15	262
33477-00	253	33491-04	256	33611-14	259	33634-25	260	33656-28	262
33477-01	253	33491-05	256	33620-02	259	33634-30	260	33657-28	262
33477-02	253	33491-06	256	33620-03	259	33644-06	261	33658-28	262
33477-03	253	33491-07	256	33620-04	259	33644-09	261	33659-28	262
33477-04	253	33491-08	256	33620-05	259	33644-13	261	33660-07	263
33477-05	253	33492-13	257	33620-06	259	33644-16	261	33660-10	263
33477-06	253	33492-16	257	33620-07	259	33644-19	261	33660-15	263
33478-98	253	33492-20	257	33620-08	259	33644-25	261	33660-20	263
33478-99	253	33494-13	257	33622-02	259	33644-32	261	33660-25	263
33479-00	253	33494-14	257	33622-03	259	33645-06	261	33660-30	263
33479-01	253	33494-17	257	33622-04	259	33645-09	261	33661-07	263
33479-02	253	33495-16	257	33622-05	259	33645-13	261	33661-10	263
33479-03	253	33496-00	257	33622-06	259	33645-16	261	33661-15	263
33479-04	253	33496-01	257	33622-07	259	33645-19	261	33661-20	263
33479-05	253	33496-12	257	33622-08	259	33645-25	261	33661-25	263
33479-06	253	33497-00	257	33623-02	259	33645-32	261	33661-30	263
33480-97	254	33498-00	257	33623-03	259	33647-06	261	33664-04	263
33480-98	254	33498-01	257	33623-04	259	33647-09	261	33664-06	263
33481-00	254	33498-12	257	33623-05	259	33647-14	261	33664-08	263
33481-01	254	33500-01	256	33623-06	259	33647-16	261	33664-10	263
33481-02	254	33500-02	256	33623-07	259	33647-19	261	33664-12	263
33481-03	254	33500-03	256	33623-08	259	33647-25	261	33665-04	263
33481-04	254	33509-03	258	33625-02	259	33647-32	261	33665-06	263
33481-05	254	33509-05	258	33625-03	259	33649-09	261	33665-08	263
33481-06	254	33509-08	258	33625-04	259	33649-14	261	33665-10	263
33482-01	253	33510-12	258	33625-05	259	33649-16	261	33665-12	263
33482-02	253	33510-14	258	33625-06	259	33649-19	261	33665-24	264
33482-03	253	33510-16	258	33625-07	259	33649-25	261	33665-26	264
33482-97	254	33520-06	258	33625-08	259	33649-32	261	33665-55	264
33482-98	254	33520-08	258	33626-25	260	33650-04	261	33665-90	264
33483-00	254	33520-10	258	33626-35	260	33650-06	261	33666-22	264
33483-01	254	33600-02	259	33627-04	260	33650-08	261	33668-03	265
33483-02	254	33600-03	259	33627-06	260	33650-10	261	33668-05	265
33483-03	254	33600-04	259	33628-03	260	33650-13	261	33668-06	265
33483-04	254	33600-05	259	33628-05	260	33650-16	261	33668-08	265
33483-05	254	33600-06	259	33630-06	260	33650-18	261	33668-09	265
33483-06	254	33600-08	259	33630-08	260	33650-20	261	33668-13	265
33484-97	254	33600-09	259	33630-10	260	33650-25	261	33668-16	265
33484-98	254	33600-10	259	33630-12	260	33650-30	261	33668-19	265
33485-00	254	33602-04	259	33630-15	260	33650-38	261	33669-05	264
33485-01	254	33602-06	259	33630-20	260	33650-44	261	33669-10	264
33485-02	254	33602-08	259	33630-25	260	33650-50	261	33669-15	264
33485-03	254	33602-10	259	33630-30	260	33651-04	261	33670-05	264
33485-04	254	33602-12	259	33631-10	260	33651-06	261	33670-06	265
33485-05	254	33602-14	259	33631-12	260	33651-08	261	33670-09	265
33485-06	254	33602-16	259	33631-15	260	33651-10	261	33670-10	264
33485-21	255	33604-04	259	33631-20	260	33651-13	261	33670-13	265
33485-99	255	33604-06	259	33631-25	260	33651-16	261	33670-15	264

33670-16	265	33697-03	271	33755-17	282	33923-22	292	34244-10	298
33670-19	265	33698-98	271	33756-17	282	33950-01	292	34244-14	298
33670-25	265	33699-00	270	33757-17	282	33950-02	292	34244-16	298
33670-32	265	33699-17	271	33758-01	281	33950-03	292	34244-17	298
33671-06	265	33700-01	272	33758-02	281	33950-04	292	34246-00	298
33671-09	265	33700-01-01	272	33758-04	280	33950-05	292	34248-00	298
33671-13	265	33700-02	272	33758-06	280	33960-15	292	34270-00	299
33671-16	265	33700-03	272	33758-08	280	33960-25	292	34270-01	299
33671-19	265	33700-04	272	33759-06	282	33960-45	292	34280-00	299
33671-25	265	33700-05	273	33759-12	282	33960-55	292	34290-00	299
33671-32	265	33700-06	273	33759-19	282	33961-15	292	34295-00	300
33672-06	265	33700-07	273	33759-25	282	33962-16	292	34296-00	300
33672-09	265	33700-08	273	33760-01	282	33963-12	293	34296-05	300
33672-13	265	33702-15	274	33760-02	282	33964-15	293	34296-10	300
33672-16	265	33703-15	274	33760-03	282	33964-19	293	34296-25	301
33672-19	265	33704-01	274	33761-21	282	33964-24	293	34296-35	301
33672-25	265	33704-02	274	33763-01	282	33965-15	293	34296-40	301
33672-32	265	33705-05	274	33763-02	282	33965-19	293	34320-10	302
33673-06	265	33705-10	274	33763-03	282	33965-24	293	34320-15	302
33673-09	265	33705-15	274	33763-04	282	33966-11	293	34320-20	302
33673-13	265	33705-20	274	33765-17	283	33966-15	293	34320-25	302
33673-16	265	33705-25	274	33767-19	283	33967-15	293	34320-27	302
33673-19	265	33706-18	274	33769-30	283	33967-20	294	34320-30	302
33673-25	265	33707-17	275	33771-71	283	33968-30	294	34320-32	302
33673-32	265	33708-19	275	33771-73	283	33968-60	294	34320-35	302
33675-06	265	33709-21	275	33801-08	284	33969-18	294	34320-40	302
33675-09	265	33710-19	275	33801-10	284	33969-23	294	34320-45	302
33675-13	265	33711-16	276	33801-12	284	33970-01	294	34320-50	302
33675-16	265	33711-18	275	33801-18	284	33970-02	294	34320-60	302
33675-19	265	33711-20	275	33801-43	284	33970-03	294	34320-70	302
33675-25	265	33711-21	275	33801-70	284	33971-24	294	34322-11	302
33675-32	265	33712-16	276	33802-01	284	33972-22	294	34322-15	302
33676-01	266	33713-16	276	33802-02	284	33973-27	294	34322-20	302
33676-02	266	33713-17	276	33802-14	284	33975-30	294	34322-25	302
33676-05	266	33714-15	276	33803-05	284	33977-28	294	34322-27	302
33676-10	266	33715-20	276	33803-07	284			34322-32	302
33676-16	266	33716-18	276	33803-43	285			34322-35	302
33676-25	266	33717-19-01	277	33804-15	285			34322-45	302
33677-05	266	33717-19-02	277	33805-22	285			34392-14	304
33677-10	266	33718-16	285	33805-33	285	34101-01	295	34393-18	304
33677-16	266	33719-17	277	33807-24	285	34101-02	295	34393-21	304
33677-25	266	33720-19	277	33809-22	285	34101-03	295	34394-14	304
33678-24	267	33720-21	277	33810-24	286	34101-04	295	34395-03	304
33679-13	267	33721-17	278	33811-06	286	34101-05	295	34395-05	304
33680-22	267	33723-17	278	33811-08	286	34101-06	295	34395-06	304
33682-01	268	33725-17	278	33812-16	286/1	34101-07	295	34395-08	304
33682-02	268	33727-17	278	33813-12	286/1	34101-08	295	34401-08	306
33682-22	267	33728-24	278	33814-44	286/2	34105-01	296	34401-10	306
33683-01	268	33729-01	278	33814-65	286/2	34110-00	296	34401-11	306
33683-02	268	33729-02	278	33820-27	287	34112-00	296	34401-12	306
33683-03	268	33729-03	278	33823-26	288	34112-02	296	34401-13	306
33683-04	268	33729-04	278	33825-26	288	34114-39	296	34401-14	306
33683-05	268	33729-05	278	33826-00	289	34116-30	296	34401-15	306
33683-06	268	33729-06	278	33826-01	289	34118-31	296	34401-16	306
33684-00	269	33729-07	278	33826-02	289	34120-23	296	34401-17	306
33686-25	270	33729-24	278	33826-03	289	34161-13	297	34401-18	306
33687-75	270	33731-22	279	33827-17	289	34162-13	297	34401-20	306
33688-45	270	33733-22	279	33828-21	290	34172-00	297	34401-22	306
33689-90	270	33740-19	279	33829-25	290	34172-01	297	34401-23	306
33690-22	270	33741-18	279	33830-23	290	34175-00	297	34401-24	306
33691-34	271	33742-18	279	33831-16	291	34175-00S	297	34401-25	306
33692-26	271	33743-18	279	33832-01	291	34175-01	297	34401-28	306
33693-32	271	33745-19	280	33832-02	291	34175-01S	297	34401-30	306
33693-33	271	33746-19	280	33832-03	291	34231-15	298	34402-08	306
33693-34	271	33747-18	280	33832-04	291	34240-27	298	34402-10	306
33694-01	270	33748-20	280	33832-05	291	34241-00	298	34402-11	306
33694-03	270	33749-10	280	33833-16	291	34242-09	298	34402-12	306
33695-40	271	33749-13	280	33910-17	292	34242-14	298	34402-13	306
33696-75	271	33749-19	280	33911-17	292	34242-16	298	34402-14	306
33697-01	271	33749-25	280	33913-17	292	34242-22	298	34402-15	306
33697-02	271	33754-17	282	33921-22	292	34243-02	298	34402-16	306

34402-17	306	34406-13	306	34410-08	306	34415-23	307	34425-10	307
34402-18	306	34406-14	306	34410-09	306	34415-24	307	34425-12	307
34402-19	306	34406-15	306	34410-10	306	34415-26	307	34425-14	307
34402-20	306	34406-16	306	34410-11	306	34415-28	307	34425-16	307
34402-22	306	34406-17	306	34410-12	306	34415-30	307	34425-18	307
34402-23	306	34406-18	306	34410-13	306	34417-08	307	34425-20	307
34402-24	306	34406-19	306	34410-15	306	34417-10	307	34425-22	307
34402-25	306	34406-20	306	34410-16	306	34417-12	307	34425-23	307
34402-28	306	34406-22	306	34410-17	306	34417-14	307	34425-24	307
34402-30	306	34406-23	306	34410-18	306	34417-16	307	34425-26	307
34403-08	306	34406-24	306	34410-19	306	34417-18	307	34425-28	307
34403-10	306	34406-25	306	34410-20	306	34417-20	307	34425-30	307
34403-11	306	34406-28	306	34410-22	306	34417-22	307	34427-08	307
34403-12	306	34406-30	306	34410-23	306	34417-23	307	34427-10	307
34403-13	306	34407-08	306	34410-24	306	34417-24	307	34427-12	307
34403-14	306	34407-09	306	34410-25	306	34417-26	307	34427-14	307
34403-15	306	34407-10	306	34410-28	306	34417-28	307	34427-16	307
34403-16	306	34407-11	306	34410-30	306	34417-30	307	34427-18	307
34403-17	306	34407-12	306	34411-08	307	34419-08	307	34427-20	307
34403-18	306	34407-13	306	34411-09	307	34419-10	307	34427-22	307
34403-19	306	34407-14	306	34411-10	307	34419-12	307	34427-23	307
34403-20	306	34407-15	306	34411-11	307	34419-14	307	34427-24	307
34403-22	306	34407-16	306	34411-12	307	34419-16	307	34427-26	307
34403-23	306	34407-17	306	34411-13	307	34419-18	307	34427-28	307
34403-24	306	34407-18	306	34411-14	307	34419-20	307	34427-30	307
34403-25	306	34407-19	306	34411-15	307	34419-22	307	34428-08	308
34403-28	306	34407-20	306	34411-16	307	34419-23	307	34428-10	308
34403-30	306	34407-22	306	34411-17	307	34419-24	307	34428-12	308
34404-08	306	34407-23	306	34411-18	307	34419-26	307	34428-14	308
34404-09	306	34407-24	306	34411-19	307	34419-28	307	34428-16	308
34404-10	306	34407-25	306	34411-20	307	34419-30	307	34428-18	308
34404-11	306	34407-28	306	34411-22	307	34420-08	307	34428-20	308
34404-12	306	34407-30	306	34411-23	307	34420-10	307	34428-22	308
34404-13	306	34408-08	306	34411-24	307	34420-12	307	34428-23	308
34404-14	306	34408-09	306	34411-25	307	34420-14	307	34428-24	308
34404-15	306	34408-10	306	34411-28	307	34420-16	307	34428-26	308
34404-16	306	34408-11	306	34411-30	307	34420-18	307	34428-28	308
34404-17	306	34408-12	306	34412-08	308	34420-20	307	34428-30	308
34404-18	306	34408-13	306	34412-10	308	34420-22	307	34429-08	308
34404-19	306	34408-14	306	34412-12	307	34420-23	307	34429-10	308
34404-20	306	34408-15	306	34412-14	307	34420-24	307	34429-12	308
34404-22	306	34408-16	306	34412-16	307	34420-26	307	34429-14	308
34404-23	306	34408-17	306	34412-18	307	34420-28	307	34429-16	308
34404-24	306	34408-18	306	34412-20	307	34420-30	307	34429-18	308
34404-25	306	34408-19	306	34412-22	307	34421-08	307	34429-20	308
34404-28	306	34408-20	306	34412-23	307	34421-10	307	34429-22	308
34404-30	306	34408-22	306	34412-24	307	34421-12	307	34429-23	308
34405-08	306	34408-23	306	34412-26	307	34421-14	307	34429-24	308
34405-09	306	34408-24	306	34412-28	307	34421-16	307	34429-26	308
34405-10	306	34408-25	306	34412-30	307	34421-18	307	34429-28	308
34405-11	306	34408-28	306	34413-08	307	34421-20	307	34429-30	308
34405-12	306	34408-30	306	34413-10	307	34421-22	307	34431-08	308
34405-13	306	34409-08	306	34413-12	307	34421-23	307	34431-10	308
34405-14	306	34409-09	306	34413-14	307	34421-24	307	34431-12	308
34405-15	306	34409-10	306	34413-16	307	34421-26	307	34431-14	308
34405-16	306	34409-11	306	34413-18	307	34421-28	307	34431-16	308
34405-17	306	34409-12	306	34413-20	307	34421-30	307	34431-18	308
34405-18	306	34409-13	306	34413-22	307	34423-08	307	34431-20	308
34405-19	306	34409-14	306	34413-23	307	34423-10	307	34431-22	308
34405-20	306	34409-15	306	34413-24	307	34423-12	307	34431-23	308
34405-22	306	34409-16	306	34413-26	307	34423-14	307	34431-24	308
34405-23	306	34409-17	306	34413-28	307	34423-16	307	34431-26	308
34405-24	306	34409-18	306	34413-30	307	34423-18	307	34431-28	308
34405-25	306	34409-19	306	34415-08	307	34423-20	307	34431-30	308
34405-28	306	34409-20	306	34415-10	307	34423-22	307	34433-08	308
34405-30	306	34409-22	306	34415-12	307	34423-23	307	34433-10	308
34406-08	306	34409-23	306	34415-14	307	34423-24	307	34433-12	308
34406-09	306	34409-24	306	34415-16	307	34423-26	307	34433-14	308
34406-10	306	34409-25	306	34415-18	307	34423-28	307	34433-16	308
34406-11	306	34409-28	306	34415-20	307	34423-30	307	34433-18	308
34406-12	306	34409-30	306	34415-22	307	34425-08	307	34433-20	308

34433-22	308	34444-18	309	34519-02	313	34570-01	321	41058-28	328
34433-23	308	34444-20	309	34520-02	314	34570-02	321	41061-16	329
34433-24	308	34444-25	309	34520-03	314	34573-35	321	41064-16	329
34433-26	308	34444-28	309	34520-04	314	34583-60	321	41068-20	329
34433-28	308	34444-30	309	34520-05	314	34584-60	321	41069-20	329
34433-30	308	34445-16	309	34520-06	314	34585-60	321	41070-29	329
34435-08	308	34445-18	309	34520-07	314	34588-01	321	41074-23	329/1
34435-10	308	34445-20	309	34520-08	314	34588-02	321	41075-24	329/1
34435-12	308	34445-25	309	34520-09	314	34588-03	321	41076-03	329/1
34435-14	308	34445-28	309	34520-10	314	34590-00	322	41076-04	329/1
34435-16	308	34445-30	309	34520-12	314	34590-01	322	41076-05	329/1
34435-18	308	34446-16	309	34520-15	314	34590-02	322	41076-07	329/1
34435-20	308	34446-18	309	34527-45	315	34596-29	322	41078-23	329/2
34435-22	308	34446-20	309	34527-70	315	34596-37	322	41079-21	329/2
34435-23	308	34446-25	309	34528-01	315	34596-42	322	41080-19	330
34435-24	308	34446-28	309	34528-02	315	34596-49	322	41081-19	330
34435-26	308	34446-30	309	34528-03	315	34597-06	322	41083-19	330
34435-28	308	34447-16	309	34530-28	315	34597-07	322	41085-20	330
34435-30	308	34447-18	309	34531-21	315	34597-08	322	41090-33	330
34436-16	308	34447-20	309	34533-17	316	34597-09	322	41091-31	330
34436-18	308	34447-25	309	34534-15	316	34597-10	322	41091-41	330
34436-20	308	34447-28	309	34534-18	316	34597-11	322	41092-30	332
34436-25	308	34447-30	309	34535-16	316	34597-12	322	41092-40	332
34436-28	308	34450-08	310	34536-14	316	34597-13	322	41092-50	332
34436-30	308	34450-10	310	34537-19	316	34597-14	322	41092-60	332
34437-16	308	34450-12	310	34538-01	316	34597-15	322	41092-70	332
34437-18	308	34450-14	310	34538-02	316	34597-16	322	41094-00	332
34437-20	308	34450-15	310	34538-03	316	34597-17	322	41096-21	332
34437-25	308	34450-16	310	34539-01	316	34597-18	322	41097-22	331
34437-28	308	34450-18	310	34539-02	316	34597-19	322	41141-25	332
34437-30	308	34450-20	310	34539-03	316	34597-20	322	41143-21	332
34438-16	308	34450-22	310	34540-01	317	34612-00	322/1	41145-21	332
34438-18	308	34450-25	310	34540-02	317	34613-00	322/1	41146-18	332
34438-20	308	34450-30	310	34540-18	317	34617-00	322/1	41146-24	332
34438-25	308	34460-08	310	34540-19	317	34620-25	323	41147-21	332
34438-28	308	34460-10	310	34540-20	317	34624-01	323	41149-22	332
34438-30	308	34460-12	310	34541-23	317/1	34624-02	323	41151-24	332
34439-16	308	34460-14	310	34542-15	317/1	34624-03	323	41155-20	333
34439-18	308	34460-15	310	34543-23	317/1	34628-01	323	41156-18	333
34439-20	308	34460-16	310	34544-18	317/1	34628-02	323	41158-01	333
34439-25	308	34460-20	310	34545-22	318	34628-15	323	41158-02	333
34439-28	308	34460-22	310	34546-16	318	34628-25	323	41158-03	333
34439-30	308	34460-25	310	34546-18	318	34628-35	323	41161-01	333
34440-01	305	34460-30	310	34547-01	320/1	34629-01	323	41161-02	333
34440-02	305	34470-08	310	34547-02	320/2	34632-25	324	41161-03	333
34440-03	305	34470-10	310	34547-03	320/1	34637-23	325	41161-04	333
34440-16	308	34470-12	310	34547-23	320/1	34639-22	325	41161-05	333
34440-18	308	34470-14	310	34547-28	320/2	34640-18	325	41210-23	334
34440-20	308	34470-15	310	34548-18	318	35548-18	320/3	41211-23	334
34440-25	308	34470-16	310	34549-14	318			41213-23	334
34440-28	308	34470-20	310	34550-13	318			41221-00	334
34440-30	308	34470-22	310	34550-18	318			41222-00	334
34441-16	308	34470-25	310	34551-17	318			41223-00	334
34441-18	308	34470-30	310	34552-16	319	41011-15	326	41224-00	334
34441-20	308	34502-15	312	34554-15	319	41011-19	326	41230-19	335
34441-25	308	34502-21	312	34554-18	319	41015-23	326	41231-19	335
34441-28	308	34514-18	312	34554-20	319	41015-26	326	41231-19	335
34441-30	308	34514-27	312	34555-15	319	41019-14	326	41236-19	335
34442-16	309	34515-01	313	34555-20	319	41020-00	326	41237-19	335
34442-18	309	34515-02	313	34555-18	319	41025-01	327	41238-19	335
34442-20	309	34515-09	312	34557-25	320	41025-02	327	41239-19	335
34442-25	309	34515-10	312	34557-22	320	41026-35	327	41242-19	336
34442-28	309	34515-11	312	34557-30	320	41026-50	327	41243-19	336
34442-30	309	34515-12	312	34558-32	320	41027-00	327	41244-19	336
34443-16	309	34515-13	312	34559-47	320	41028-00	327	41245-19	336
34443-18	309	34515-15	312	34560-57	320	41051-20	328	41250-11	336
34443-20	309	34515-20	312	34562-24	321	41052-20	328	41250-15	336
34443-25	309	34518-01	312	34562-32	321	41053-20	328	41250-18	336
34443-28	309	34518-02	312	34562-48	321	41054-20	328	41253-07	336
34443-30	309	34518-03	312	34562-64	321	41056-18	328	41253-11	336
34444-16	309	34519-01	313			41056-28	328	41253-15	336
						41058-18	328	41253-18	336

41254-06 337	41405-17 339	41513-01 344	43	43373-13 375
41254-10 337	41405-27 339	41513-02 344		43376-13 375
41254-13 337	41406-01 339	41513-03 344		43377-13 375
41254-16 337	41406-02 339	41513-04 344		43380-13 375
41254-19 337	41420-01 340	41513-05 344		43386-13 375
41254-25 337	41420-02 340	41514-01 344		43387-02 376
41254-32 337	41420-03 340	41514-02 344		43388-02 376
41254-38 337	41421-01 340	41514-03 344		43389-02 376
41290-21 337	41421-02 340	41514-04 344		43390-05 376
41294-40 337	41421-03 340	41514-05 344		43391-13 376
41295-05 337	41422-01 340	41515-01 344		43402-05 377
41295-06 337	41422-02 340	41515-02 344		43402-10 377
41295-07 337	41422-03 340	41515-03 344		43402-15 377
41295-08 337	41430-01 340	41515-04 344		43402-18 377
41295-09 337	41430-02 340	41515-05 344		43402-20 377
41295-10 337	41430-03 340	41520-03 344/1		43402-25 377
41295-11 337	41431-01 340	41520-05 344/1		43402-35 377
41295-12 337	41431-02 340	41522-03 344/1		43402-40 377
41295-15 337	41431-03 340	41522-05 344/1		43402-45 377
41297-06 337	41432-01 340	41524-03 344/1		43404-10 377
41297-07 337	41432-02 340	41524-05 344/1	43404-20 377	
41297-08 337	41432-03 340	41526-03 344/1	43404-24 377	
41297-09 337	41440-01 340	41526-05 344/1	43404-30 377	
41297-10 337	41440-02 340	41527-03 344/1	43404-35 377	
41297-11 337	41440-03 340	41527-05 344/1	43410-02 377	
41297-12 337	41441-01 340	41529-03 344/1	43412-02 377	
41298-12 337	41441-02 340	41529-05 344/1	43414-02 378	
41299-03 336	41441-03 340	41540-02 344/2	43420-01 378	
41299-05 336	41442-01 340	41540-03 344/2	43420-02 378	
41299-07 336	41442-02 340	41540-04 344/2	43420-03 378	
41300-02 337/1	41442-03 340	41540-05 344/2	43424-13 378	
41300-03 337/1	41443-26 341	41542-02 344/2	43441-01 378	
41300-04 337/1	41444-01 341	41542-03 344/2	43441-02 378	
41300-05 337/1	41444-02 341	41542-04 344/2	43443-13 378	
41301-15 337/1	41444-03 341	41542-05 344/2	43445-13 378	
41301-20 337/1	41445-25 341/1	41661-40 361	43447-13 378	
41301-25 337/1	41446-00 341/1	41661-50 361	43461-13 378	
41301-35 337/1	41448-02 342	41662-50 361	43462-13 378	
41302-02 337/1	41448-03 342	41663-01 361	43482-20 378	
41303-09 337/2	41448-04 342	41663-02 361	43487-14 378	
41303-12 337/2	41449-01 342	41664-10 362	43511-13 379	
41303-15 337/2	41449-02 342	41664-14 362	43513-14 379	
41303-18 337/2	41449-03 342	41665-10 362	43515-14 379	
41303-25 337/2	41451-01 343	41665-14 362	43517-09 379	
41303-30 337/2	41451-02 343	41666-00 362	43524-10 379	
41303-45 337/2	41451-03 343	41666-30 363	43525-05 379	
41304-06 338	41452-01 343	41667-50 363	43525-07 379	
41304-08 338	41452-02 343	41668-50 363	43542-12 380	
41304-10 338	41452-03 343	41669-50 363	43544-12 380	
41305-05 338	41453-01 343	41670-50 363	43546-13 380	
41305-06 338	41453-02 343	41801-01 368	43548-13 380	
41305-07 338	41453-03 343	41802-00 368/3	43583-07 380	
41305-08 338	41454-01 343	41802-02 368	43602-01 381	
41305-09 338	41454-02 343	41803-01 368/2	43602-02 381	
41305-10 338	41454-03 343	41807-00 368/2	43602-03 381	
41305-12 338	41458-20 343	41810-10 368/2	43608-12 381	
41305-15 338	41510-01 344	41821-21 368/1	43609-14 381	
41305-18 338	41510-02 344	41822-22 368/1	43610-01 381	
41305-20 338	41510-03 344	41826-26 368/1	43610-02 381	
41305-25 338	41510-04 344	41830-30 368/1	43613-00 381	
41305-30 338	41510-05 344	41832-32 368/1	43614-00 381	
41306-05 337/1	41511-01 344	41842-42 368/4	43614-01 381	
41306-07 337/1	41511-02 344	41842-44 368/4	43614-12 381	
41306-09 337/1	41511-03 344	41843-50 368/4	43614-23 381	
41306-12 337/1	41511-04 344	41850-41 368/4	43614-34 381	
41307-00 338	41511-05 344	41860-14 369	43614-45 381	
41307-03 338	41512-01 344	41860-17 369	43614-56 381	
41307-04 338	41512-02 344	41860-20 369	43614-67 381	
41307-05 338	41512-03 344	41880-01 369	43614-78 381	
41307-06 338	41512-04 344	41880-02 369	43802-07 382	
41401-16 339	41512-05 344	41880-03 369	43803-07 382	
			43101-03 370	
			43101-04 370	
			43104-07 370	
			43107-08 370	
			43109-07 370	
			43109-09 370	
			43110-08 370	
			43111-07 370	
			43113-07 370	
			43115-05 370	
			43125-05 370	
			43125-07 370	
			43128-08 370	
			43129-07 371	
			43132-08 371	
			43133-08 371	
			43135-07 371	
			43139-07 371	
			43140-08 371	
			43141-08 371	
			43150-11 371	
			43170-00 371	
			43170-01 371	
			43170-02 371	
			43170-03 371	
			43172-13 371	
			43180-01 372	
			43180-02 372	
			43180-03 372	
			43181-01 372	
			43181-02 372	
			43181-03 372	
			43183-13 372	
			43187-13 372	
			43210-02 372	
			43210-03 372	
			43213-12 372	
			43218-12 372	
			43221-11 373	
			43228-12 373	
			43231-12 373	
			43245-12 373	
			43251-12 373	
			43253-12 373	
			43258-12 373	
			43262-12 373	
			43271-11 373	
			43273-13 373	
			43304-12 374	
			43305-12 374	
			43308-12 374	
			43309-12 374	
			43310-13 374	
			43311-13 374	
			43321-12 374	
			43327-12 374	
			43330-13 374	
			43334-12 374	
			43336-12 374	
			43340-13 374	
			43342-12 374	
			43351-01 375	
			43351-02 375	
			43351-03 375	
			43353-13 375	
			43355-13 375	
			43357-13 375	
			43370-12 375	
			43372-13 375	

43804-07	382	44109-10	391	45010-65	399	45112-03	407	45261-08	412
43805-07	382	44111-10	391	45010-75	399	45112-04	407	45261-14	412
43810-10	382	44114-10	391	45011-00	399	45112-05	407	45261-16	412
43811-10	382	44115-10	391	45011-03	399	45114-00	407	45263-08	412
43813-10	382	44119-10	391	45011-04	399	45115-00	407	45263-14	412
43820-10	382	44121-10	391	45011-05	399	45115-01	407	45265-08	412
43821-10	382	44125-06	391	45011-07	399	45115-02	407	45267-20	412
43823-10	382	44127-06	391	45011-08	399	45115-03	407	45267-25	412
43830-10	383	44129-07	391	45012-00	399	45115-04	407	45267-30	412
43831-10	383	44150-01	392	45012-40	399	45115-05	407	45269-30	412
43833-10	383	44150-03	392	45012-55	399	45116-00	407	45271-08	412
43840-10	383	44150-05	392	45012-65	399	45117-00	407	45273-08	412
43841-10	383	44150-10	392	45012-75	399	45117-01	407	45275-08	412
43843-10	383	44150-15	392	45014-00	399	45117-02	407	45310-40	413
43850-08	383	44151-05	392	45015-00	399	45117-03	407	45312-55	413
43851-08	383	44151-10	392	45015-45	399	45117-04	407	45313-55	413
43852-08	383	44151-15	392	45015-55	399	45117-05	407	45315-55	413
43853-08	383	44164-10	392	45015-65	399	45133-01	408	45317-55	413
43855-07	384	44166-07	392	45018-00	399	45133-02	408	45320-70	413
43857-07	384	44181-10	392	45018-50	399	45133-03	408	45321-70	413
43861-07	384	44190-08	392	45018-60	399	45133-04	408	45322-70	413
43863-07	384	44202-08	392	45018-70	399	45133-05	408	45350-40	413
43865-07	384	44210-10	392	45018-80	399	45150-18	408	45350-70	413
43869-07	384	44220-10	392	45030-04	401	45151-16	408	45352-40	413
43881-07	384	44240-09	393	45030-06	401	45152-01	408	45353-60	413
43883-07	384	44242-09	393	45030-07	401	45152-02	408	45355-60	413
43885-07	384	44246-09	393	45030-08	401	45153-16	408	45357-40	413
43887-07	384	44254-09	393	45030-10	401	45160-15	408	45359-40	413
43891-09	385	44256-09	393	45036-03	402	45162-18	408	45360-35	413
43902-09	385	44258-09	393	45036-06	402	45164-17	408	45362-45	414
43903-09	385	44265-10	393	45036-07	402	45165-17	408	45363-45	414
43907-10	385	44267-10	393	45036-08	402	45171-12	409	45365-45	414
43909-10	385	44274-11	393	45036-09	401	45180-01	409	45367-50	414
43914-10	385	44300-00	394	45036-10	401	45180-02	409	45369-50	414
43916-10	385	44301-00	394	45060-01	403	45180-03	409	45370-50	414
43924-11	386	44310-00	394	45060-02	403	45181-13	409	45371-40	414
43926-11	386	44311-00	394	45060-03	403	45184-16	409	45373-30	414
43940-05	386	44320-00	394	45060-04	403	45185-15	409	45375-60	414
43940-08	386	44330-00	394	45060-05	403	45190-01	409	45377-60	414
43942-05	386	44340-00	394	45061-00	403	45190-02	409	45383-30	414
43942-08	386	44350-00	394	45070-01	403	45192-01	409	45385-01	414
43944-07	387	44370-00	394/1	45070-02	403	45192-02	409	45385-02	414
43946-07	387	44371-00	394/1	45070-03	403	45192-03	409	45387-01	414
43948-10	387	44372-00	394/1	45070-04	403	45192-04	409	45387-02	414
43950-10	387	44373-00	394/1	45070-05	403	45192-05	409	45390-35	415
43952-10	387	44374-00	394/1	45070-06	403	45192-06	409	45390-50	415
43953-10	387	44380-00	394/2	45071-00	403	45193-01	409	45391-35	415
43955-10	387	44390-00	394/2	45072-01	404	45193-02	409	45392-35	415
43956-10	387	44404-00	394/2	45073-01	404	45193-03	409	45393-50	415
		44404-00G	394/2	45073-02	404	45194-01	410	45394-50	415
		44406-00	394/2	45073-03	404	45194-02	410	45400-01	416
		44406-00G	394/2	45073-04	404	45194-03	410	45400-02	416
		44408-00	395	45073-05	404	45194-04	410	45400-03	416
		44420-09	395	45073-06	404	45201-11	410	45401-25	416
		44422-09	395	45074-01	404	45201-13	410	45402-10	416
		44424-08	395	45076-01	404	45203-11	410	45403-13	416
		44425-10	395	45096-50	407	45206-14	410	45404-13	416
		44426-09	395	45096-75	407	45206-16	410	45410-01	417
		44428-09	395	45097-10	407	45207-16	410	45411-01	417
				45097-15	407	45208-14	410	45412-01	417
				45109-00	407	45220-16	411	45413-01	417
				45110-00	407	45222-17	411	45414-01	417
				45110-01	407	45225-02	411	45701-01	418
				45110-02	407	45243-14	411	45701-02	418
				45110-03	407	45245-12	411	45703-15	418
				45110-04	407	45246-12	411	45704-15	418
				45110-05	407	45246-14	411	45705-15	418
				45111-00	407	45251-10	412	45706-35	418
				45112-00	407	45253-11	412	45709-10	418
				45112-01	407	45255-08	412	45709-14	418
				45112-02	407	45257-08	412	45709-16	418

45709-20	418	47050-03	421	47235-11	427	47384-15	435	47473-03	442
45709-26	418	47050-04	421	47237-01	427	47385-15	435	47474-01	442
45709-28	418	47050-05	421	47237-02	427	47386-01	435	47474-02	442
45709-30	418	47050-06	421	47237-03	427	47386-02	435	47474-03	442
45710-15	419	47050-07	421	47239-01	427	47387-01	435	47481-05	442/1
45711-15	419	47060-01	421	47239-02	427	47387-02	435	47482-05	442/1
45713-15	419	47060-02	421	47240-19	427	47390-03	436	47484-04	442/1
45715-17	419	47060-03	421	47241-00	427	47390-04	436	47484-06	442/1
45720-03	419	47102-01	421	47242-00	427	47390-05	436	47484-08	442/1
45720-06	419	47102-02	421	47242-01	427	47392-03	436	47486-16	442/1
45720-10	419	47102-03	421	47251-21	428	47392-04	436	47487-16	442/1
45722-03	419	47103-01	422	47255-01	428	47392-05	436	47489-16	442/1
45722-06	419	47103-02	422	47255-02	428	47410-04	437	47502-16	443
45722-10	419	47103-03	422	47256-20	428	47410-05	437	47504-18	443
45722-12	419	47112-01	421	47303-03	428	47410-16	437	47507-17	443
45722-15	419	47112-02	421	47303-04	428	47411-16	437	47507-19	443
45722-20	419	47112-03	421	47303-05	428	47413-19	437	47511-21	443
45722-25	419	47113-03	421	47303-06	428	47414-21	437	47513-21	443
45724-03	419	47116-13	423	47304-01	429	47415-18	437	47514-16	443
45724-06	419	47118-13	423	47304-02	429	47417-19	437	47516-16	443
45724-10	419	47120-35	423	47304-03	429	47419-19	437	47518-21	444
45724-12	419	47120-50	423	47304-04	429	47420-01	438	47520-21	444
45724-15	419	47120-75	423	47305-01	429	47420-02	438	47521-01	444
45724-20	419	47120-90	423	47305-02	429	47420-03	438	47521-02	444
45724-25	419	47124-35	423	47305-03	429	47420-04	438	47521-03	444
45725-05	419	47124-50	423	47311-10	430	47420-20	438	47522-01	445
45725-10	419	47124-75	423	47311-25	430	47421-21	438	47522-04	445
45730-03	419	47124-90	423	47311-30	430	47421-23	439	47522-05	445
45730-06	419	47139-12	423	47315-00	430	47422-22	439	47522-07	445
45730-10	419	47139-14	423	47316-00	430	47423-22	439	47522-09	445
45732-03	419	47139-16	423	47316-16	431	47424-16	439	47523-01	446
45732-06	419	47139-18	423	47317-00	430	47425-19	439	47523-02	446
45732-10	419	47151-15	424	47317-11	431	47426-22	439	47526-16	446
45733-05	419	47151-18	424	47317-65	431	47428-21	439	47527-16	446
45733-10	419	47154-18	424	47317-70	431	47430-22	439	47529-16	446
45735-05	419	47154-20	424	47317-90	431	47450-04	439	47532-19	446
45735-10	419	47155-20	424	47318-11	431	47451-04	439	47533-19	446
45736-15	419	47158-20	424	47318-65	431	47454-04	440	47534-19	446
45737-15	419	47159-20	424	47318-70	431	47454-07	440	47540-16	447
45741-03	419	47161-16	424	47318-90	431	47454-09	440	47541-14	447
45741-06	419	47161-20	424	47319-35	432	47454-12	440	47542-12	447
45741-10	419	47167-18	425	47319-45	432	47455-06	440	47551-16	447
45743-03	419	47169-18	425	47323-19	430	47458-04	440	47551-16CL	447
45743-06	419	47171-14	425	47325-19	430	47458-07	440	47552-16	447
45743-10	419	47173-14	425	47331-20	433	47458-09	440	47553-15	447/1
45745-03	419	47181-18	425	47331-25	433	47458-12	440	47554-01	447/1
45745-06	419	47185-18	425	47331-30	433	47460-04	440	47554-02	447/1
45745-10	419	47191-01	425	47331-40	433	47460-07	440	47554-03	447/1
45747-03	419	47191-02	425	47332-20	433	47461-00	440	47555-08	447/1
45747-06	419	47191-03	425	47332-25	433	47463-10	440	47556-16	447/1
45747-10	419	47191-04	425	47332-30	433	47463-12	440	47557-17	447/1
45751-16	420	47192-18	426	47332-40	433	47463-14	440	47558-15	448
45753-16	420	47195-01	426	47342-25	433	47470-04	441	47559-20	448
45755-16	420	47195-02	426	47342-30	433	47470-05	441	47560-18	448
45757-16	420	47197-01	426	47342-40	433	47470-06	441	47562-18	448
45760-01	420	47197-02	426	47345-15	433/1	47470-07	441	47563-22	448
45760-02	420	47223-00	426	47347-20	433/1	47471-02	441	47564-16	448
45762-01	420	47223-01	426	47350-26	433/2	47471-03	441	47565-10	448
45762-02	420	47223-02	426	47351-26	433/2	47471-04	441	47566-12	448
45766-35	420	47223-03	426	47352-24	433/2	47471-05	441	47571-23	449
45766-40	420	47223-04	426	47355-03	433/2	47471-06	441	47572-23	449
45766-45	420	47223-05	426	47370-16	434	47471-07	441	47573-23	449
45766-50	420	47224-00	426	47371-16	434	47471-08	441	47575-23	449
45802-16	420	47224-01	426	47372-16	434	47471-10	441	47601-21	449
45803-16	420	47224-02	426	47373-16	434	47471-12	441	47607-01	449
45805-16	420	47224-03	426	47374-16	434	47472-10	441	47607-02	449
		47224-04	426	47375-19	434	47472-12	441	47607-03	449
		47224-05	426	47376-16	435	47472-14	441	47607-04	449
		47235-05	427	47379-16	435	47472-16	441	47607-05	449
		47235-07	427	47380-15	435	47473-01	442	47607-06	449
		47235-09	427	47382-15	435	47473-02	442	47620-00	450

47620-01 450
47620-02 450
47620-03 450
47620-04 450
47620-05 450
47620-06 450
47630-00 450
47630-01 450
47630-02 450
47630-03 450
47630-04 450
47636-01 450
47636-02 450
47636-03 450
47636-04 450
47641-01 450
47641-02 450
47641-03 450
47642-01 450
47642-02 450
47642-03 450

49

49102-16 451
49103-17 451
49104-15 451
49105-16 451
49106-01 451
49106-02 451
49107-19 451
49108-15 451
49109-19 451
49110-19 452
49111-15 452
49115-01 452
49115-02 452
49117-11 452
49119-01 451
49119-02 451
49119-14 453
49230-11 453
49231-12 453
49231-14 453
49231-16 453
49235-19 453
49250-16 453
49250-18 453
49255-16 453
49255-99 453
49265-12 454
49265-14 454
49267-12 454
49270-16 454
49270-19 454
49272-13 454
49274-09 454
49274-11 454
49274-13 454
49274-15 454
49275-01 454/1
49275-02 454/1
49275-03 454/1
49275-04 454/1
49275-05 454/1
49287-02 455
49287-03 455
49287-04 455
49287-05 455
49288-02 455
49288-03 455

49288-04 455
49288-05 455
49310-00 455
49310-01 455
49310-02 455
49310-03 455
49310-04 455
49310-05 455
49310-10 455
49310-12 455
49315-00 456
49315-01 456
49315-02 456
49315-03 456
49315-10 456
49317-00 456
49317-01 456
49317-02 456
49317-03 456
49317-10 456
49320-00 457
49320-01 457
49320-02 457
49320-03 457
49320-10 457
49320-20 457
49340-00 457
49342-01 458
49342-02 458
49342-03 458
49342-04 458
49342-05 458
49345-01 458
49345-02 458
49345-03 458
49345-04 458
49345-05 458
49350-01 459
49350-02 459
49360-10 459
49400-01 459
49501-22 459
49501-23 459
49501-24 459
49503-22 459
49503-23 459
49503-24 459
49605-07 460
49605-10 460
49605-11 460
49605-12 460
49605-14 460
49605-16 460
49610-12 460
49610-13 460
49610-16 460
49613-10 461
49615-12 461
49620-15 461/1
49623-16 461/1
49624-10 461/1
49627-01 461/1
49630-02 461/1
49631-00 461/2
49635-18 462
49640-05 462
49640-07 462
49640-09 462
49650-06 462
49650-07 462
49650-09 462

49650-11 462
49660-18 463
49665-24 463
49670-19 463
49670-20 463
49670-23 463
49671-01 463/1
49671-02 463/1
49673-01 463/2
49673-02 463/2
49673-03 463/2
49673-04 463/2
49675-18 463/3
49680-10 463/3
49680-20 463/3
49685-21 463/3
49691-15 463/3
49692-15 463/3
49695-01 463/5
49695-02 463/5
49696-18 463/6
49700-01 464
49700-02 464
49705-08 464/1
49705-12 464/1
49705-16 464/1
49705-20 464/1
49710-04 464/2
49710-06 464/2
49710-08 464/2
49711-04 464/2
49711-06 464/2
49713-06 464/2
49713-08 464/2

51

51103-18 465
51103-20 465
51103-22 465
51109-24 465
51111-23 465
51112-06 465
51112-08 465
51131-22 465
51133-23 465
51135-01 465
51135-02 465
51139-25 465
51143-24 465
51151-19 465
51165-22 466
51167-22 466
51168-23 466
51169-23 466
51170-24 466
51171-22 466
51172-19 466
51173-21 466
51174-21 466
51177-23 466
51181-19 467
51183-19 467
51185-19 467
51187-19 467
51191-19 467
51193-19 467
51202-19 467
51203-19 467
51205-18 467
51205-23 467

51207-21 467
51209-20 467
51210-20 468
51211-21 468
51213-21 468
51219-22 468
51250-28 468
51252-28 468
51256-28 468
51257-40 468
51257-50 468
51259-03 468
51259-04 468
51259-05 468
51260-00 469
51270-00 470
51270-04 470
51291-00 470
51292-00 470
51293-45 470
51293-90 470

53

53101-22 471
53102-20 471
53103-22 471
53111-18 471
53115-01 471
53115-02 471
53115-03 471
53115-04 471
53130-00 472
53131-20 472
53132-20 472
53132-30 472
53132-40 472
53132-50 472
53132-60 472
53150-00 472
53152-00 472
53154-00 472
53157-00 472
53158-02 472
53158-03 472
53162-00 472
53164-01 472
53164-02 472
53170-00 472
53175-00 472
53177-01 472
53177-02 472
53230-01 473
53230-02 473
53230-03 473
53230-04 473
53230-05 473
53230-06 473
53230-07 473
53230-08 473
53240-01 473
53240-02 473
53240-03 473
53240-04 473
53240-05 473
53240-06 473
53240-07 473
53240-08 473
53250-01 473
53250-02 473
53250-03 473

53250-04 473
53250-05 473
53250-06 473
53250-07 473
53250-08 473
53260-01 473
53260-02 473
53260-03 473
53260-04 473
53260-05 473
53260-06 473
53260-07 473
53260-08 473
53270-08 473
53270-10 473
53270-12 473
53270-14 473
53270-16 473
53270-18 473
53270-20 473
53270-22 473
53270-24 473
53270-26 473
53270-28 473
53270-30 473
53272-08 473
53272-10 473
53272-12 473
53272-14 473
53272-16 473
53272-18 473
53272-20 473
53272-22 473
53272-24 473
53272-26 473
53272-28 473
53272-30 473
53274-12 473
53276-10 473
53280-01 474
53280-02 474
53280-03 474
53280-04 474
53280-05 474
53280-06 474
53280-07 474
53280-08 474
53280-09 474
53280-10 474
53280-11 474
53290-01 475
53290-02 475
53290-03 475
53290-04 475
53290-05 475
53290-06 475
53290-07 475
53290-08 475

55

55111-13 476
55111-14 476
55113-14 476
55115-07 476
55116-15 476
55117-17 476
55118-16 477
55119-16 477
55120-15 477
55122-16 477

61805-50	529	63173-05	533	65216-18	540	67132-00	552	67206-28	554
61805-70	529	63173-06	533	65216-21	540	67147-27	552	67206-29	554
61805-90	529	63173-07	533	65216-23	540	67149-27	552	67206-30	554
61810-05	529	63173-08	533	65217-13	540	67150-00	552	67207-08	554
61810-10	529	63174-00	268	65217-16	540	67160-00	552	67207-09	554
61810-15	529	63175-27	534	65217-18	540	67169-00	553	67207-10	554
61810-20	529	63180-17	534	65217-21	540	67169-01	553	67207-11	554
61810-25	529	63180-21	534	65217-23	540	67170-00	553	67207-12	554
61810-30	529	63180-24	534	65220-13	540	67172-20	553/1	67207-13	554
61810-35	529	63180-27	534	65220-22	540	67172-28	553/1	67207-14	554
61810-40	529	63210-32	534	65220-25	540	67175-08	553/1	67207-15	554
61810-45	529	63231-01	535	65220-28	540	67177-11	553/1	67207-16	554
61810-50	529	63231-02	535	65221-13	540	67178-12	553/2	67207-17	554
61810-70	529	63231-03	535	65221-22	540	67178-14	553/2	67207-18	554
61810-90	529	63231-04	535	65221-25	540	67178-15	553/2	67207-19	554
61820-05	529	63231-05	535	65221-28	540	67178-16	553/2	67207-20	554
61820-10	529	63231-06	535	65226-22	540	67179-14	553/2	67207-21	554
61820-15	529	63232-01	536	65226-25	540	67184-39	554	67207-22	554
61820-20	529	63232-02	536	65226-28	540	67185-35	554	67207-23	554
61820-25	529			65227-22	540	67201-08	554	67207-24	554
61820-30	529			65227-25	540	67201-10	554	67207-25	554
61820-35	529			65227-28	540	67201-12	554	67207-26	554
61820-40	529			65230-21	541	67201-14	554	67207-27	554
61820-45	529			65230-23	541	67201-16	554	67207-28	554
61820-50	529			65230-25	541	67201-18	554	67207-29	554
61820-70	529			65231-21	541	67201-20	554	67207-30	554
61820-90	529			65231-23	541	67201-22	554	67208-08	554
61910-01	530			65231-25	541	67201-24	554	67208-10	554
61910-02	530			65236-25	541	67201-26	554	67208-12	554
61910-03	530			65237-25	541	67201-28	554	67208-14	554
61910-04	530			65238-33	541	67201-30	554	67208-16	554
61920-14	530/1			65239-33	541	67201-32	554	67208-18	554
61920-23	530/1			65241-23	542	67201-34	554	67208-20	554
61930-18	530/1			65242-30	542	67201-36	554	67208-22	554
61930-21	530/1			65255-19	543	67205-08	554	67208-24	554
				65256-19	543	67205-10	554	67208-26	554
				65259-24	543	67205-12	554	67208-28	554
				65261-15	544	67205-14	554	67208-30	554
				65263-15	544	67205-16	554	67208-32	554
				65263-20	544	67205-18	554	67208-34	554
				65265-26	545	67205-20	554	67208-36	554
				65265-28	545	67205-22	554	67211-08	555
				65270-15	545	67205-24	554	67211-10	555
				65272-07	545	67205-26	554	67211-12	555
				65272-10	545	67205-28	554	67211-14	555
				65274-00	545	67205-30	554	67211-16	555
				65280-05	546	67205-32	554	67211-18	555
				65280-07	546	67205-34	554	67211-20	555
				65280-10	546	67205-36	554	67213-06	555
				65282-26	546	67205-38	554	67213-08	555
				65284-08	547	67205-40	554	67213-10	555
				65284-23	547	67206-08	554	67213-12	555
				65290-30	548	67206-09	554	67213-14	555
				65291-30	548	67206-10	554	67213-16	555
				65310-15	549	67206-11	554	67213-18	555
				65310-21	549	67206-12	554	67213-20	555
				65310-29	549	67206-13	554	67213-22	555
				65310-35	549	67206-14	554	67213-24	555
						67206-15	554	67219-08	555
						67206-16	554	67219-10	555
						67206-17	554	67219-12	555
						67206-18	554	67219-14	555
						67206-19	554	67219-16	555
						67206-20	554	67219-18	555
						67206-21	554	67219-20	555
						67206-22	554	67219-22	555
						67206-23	554	67219-24	555
						67206-24	554	67220-00	555
						67206-25	554	67220-12	555
						67206-26	554	67220-14	555
						67206-27	554	67220-16	555

65

63

67

67220-18	555	69402-21	567	71262-01	573	71410-08	578	71438-25	580
67220-20	555	69402-25	567	71262-02	573	71410-09	578	71438-29	580
67220-22	555	69450-18	568	71271-01	573	71410-10	578	71438-33	580
67220-24	555	69455-00	568	71271-02	573	71410-11	578	71438-37	580
67220-26	555	69456-00	568	71271-03	573	71410-12	578	71438-41	580
67220-28	555	69457-12	568	71281-01	573	71410-13	578	71441-34	581
67220-30	555	69457-31	568	71281-02	573	71410-14	578	71500-18	582
67220-32	555	69458-00	568	71281-03	573	71410-15	578	71502-25	582
67220-34	555	69458-10	568	71291-00	573	71410-16	578	71503-25	582
67220-36	555	69460-00	568	71291-01	573	71410-17	578	71504-25	582
67220-38	555			71291-02	573	71410-18	578	71505-24	582
67240-08	556			71291-03	573	71410-19	578	71507-28	582
67240-11	556			71300-01	574	71410-20	578	71508-17	582
67240-13	556			71301-01	574	71410-21	578	71510-18	582
67240-16	556			71301-02	574	71410-22	578	71512-20	583
67240-21	556			71301-03	574	71410-23	578	71512-28	583
67240-26	556			71303-01	574	71410-24	578	71514-24	583
67240-32	556			71303-02	574	71410-25	578	71515-24	583
67250-07	556			71303-03	574	71410-26	578	71524-06	583
67251-07	556			71303-04	574	71410-27	578	71524-08	583
				71303-05	574	71410-28	578	71524-10	583
				71305-01	574	71410-29	578	71525-06	583
				71305-02	574	71410-30	578	71525-08	583
				71305-03	574	71415-01	578	71525-10	583
				71305-04	574	71415-02	578	71531-23	583
				71305-05	574	71415-03	578	71532-21	583
				71306-00	575	71415-04	578	71533-21	583
				71306-01	575	71415-05	578	71536-21	584
				71306-02	575	71415-06	578	71536-28	584
				71306-03	575	71415-07	578	71537-27	584
				71306-04	575	71415-08	578	71539-26	584
				71306-05	575	71415-09	578	71540-27	585
				71306-06	575	71415-10	578	71542-20	585
				71306-07	575	71415-11	578	71543-32	585
				71306-08	575	71415-12	578	71545-27	585
				71307-00	576	71415-13	578	71547-23	585
				71308-00	576	71415-14	578	71549-25	585
				71309-00	576	71415-15	578	71559-26	586
				71310-20	577	71415-16	578	71565-28	586
				71310-25	577	71415-17	578	71567-26	586
				71310-30	577	71415-18	578	71580-32	586
				71310-35	577	71415-19	578	71581-32	586
				71310-40	577	71420-01	579	71582-32	586
				71313-20	577	71420-03	579	71583-32	586
				71313-25	577	71420-05	579	71584-28	586
				71313-30	577	71420-07	579	71585-25	586
				71313-35	577	71420-09	579	71590-04	587
				71313-40	577	71420-11	579	71592-01	587
				71315-40	577	71420-13	579	71592-02	587
				71319-28	577	71420-15	579	71592-03	587
				71319-38	577	71420-17	579	71592-04	587
				71351-10	477/577	71420-19	579	71593-00	587
				71351-15	477/577	71420-21	579	71594-40	587
				71360-24	577	71420-23	579	71596-40	587
				71361-24	577	71420-25	579	71598-27	587
				71362-24	577	71424-08	579	71604-01	588
				71363-24	577	71424-13	579	71604-02	588
				71364-24	577	71425-08	579	71604-21	588
				71365-24	577	71426-08	579	71604-28	588
				71404-14	578	71426-13	579	71605-26	588
				71404-26	578	71430-10	580	71606-24	588
				71405-14	578	71430-12	580	71611-25	588
				71406-14	578	71430-14	580	71612-21	588
				71406-26	578	71430-16	580	71613-28	589
				71410-01	578	71430-18	580	71615-01	589
				71410-02	578	71430-20	580	71615-02	589
				71410-03	578	71436-06	580	71617-04	589
				71410-04	578	71438-00	580	71618-23	589
				71410-05	578	71438-13	580	71619-23	589
				71410-06	578	71438-17	580	71621-01	590
				71410-07	578	71438-21	580	71621-01-25	590

71

69

89145-30 620
89145-31 620
89145-35 620
89146-20 268,621
89147-10 621
89147-21 620
89147-24 620
89147-25 621
89147-30 620
89147-31 620
89147-35 620
89147-40 620
89147-42 620
89148-25 621
89148-31 621/1
89148-32 621/1
89148-35 621/1
89148-50 621
89152-08 622
89152-10 622
89152-12 622
89155-00 621/2
89155-08 622
89155-10 622
89155-13 622
89155-15 622
89155-19 622
89156-00 621/2
89159-14 622
89159-16 622
89159-19 622
89159-24 622
89164-14 622
89164-16 622
89164-19 622
89164-24 622
89164-29 622
89164-34 622
89164-39 622
89169-14 622
89169-16 622
89169-19 622
89169-24 622
89169-29 622
89169-34 622
89169-39 622
89174-14 622
89174-16 622
89174-19 622
89174-24 622
89174-29 622
89174-34 622
89174-39 622
89179-14 622
89179-16 622
89179-19 622
89179-24 622
89179-29 622
89179-34 622
89179-39 622
89179-49 622
89179-59 622
89270-15 227
89500-00 626

91010-12 628
91010-13 628
91010-14 628
91010-15 628
91010-16 628
91010-17 628
91010-18 628
91010-21 628
91010-31 628
91010-33 628
91010-34 628
91010-35 628
91010-36 628
91011-51 629
91011-52 629
91011-53 629
91011-54 629
91011-55 629
91011-56 629
91011-61 629
91011-62 629
91020-01 629
91020-02 629
91020-03 629
91020-04 629
91022-05 629
91022-10 629
91022-20 629
91024-10 629
91024-15 629
91024-20 629
91030-02 629
91030-04 629
91030-06 629
91102-11 630
91104-11 630
91109-11 630
91113-11 630
91115-11 630
91122-16 630
91123-16 630
91124-16 630
91125-16 630
91127-16 630
91142-16 631
91144-16 631
91146-16 631
91148-16 631
91152-19 631
91154-19 631
91157-19 631
91159-19 631
91162-19 632
91164-19 632
91166-19 632
91167-19 632
91169-19 632
91172-03 632
91172-07 632
91172-12 632
91800-18 634
91800-21 634
91800-25 634
91801-18 634
91801-21 634
91801-25 634
91900-18 634
91900-21 634
91900-25 634
91901-18 634/1
91901-23 634/1

91901-28 634/1
91902-18 634/1
91902-23 634/1
91902-28 634/1
91999-43 634/1
91999-45 634/1

98

98000-01 635

R065

R065-020080-003
..... 633
R065-020080-005
..... 633
R065-040000-003
..... 633
R065-040000-005
..... 633
R065-040125-003
..... 633
R065-040125-005
..... 633
R065-040285-003
..... 633
R065-040285-005
..... 633

R190

R190.03 622
R190.05 622
R190.07 622
R190.10 622
R191.03 622
R191.05 622
R191.07 622
R191.10 622
R390.03 622
R390.05 622
R390.07 622
R390.10 622

91

91010-01 628
91010-02 628
91010-03 628
91010-11 628

A

Ablfallzange, SAUERBRUCH.....	227	Anatomische Pinzette, CUSHING.....	83	Arterienklemme, LAWRENCE.....	119
Abortuskürette, PESTALOZZA.....	606	Anatomische Pinzette, CUSHING-TAYLOR.....	87	Arterienklemme, LERICHE.....	111
Abortuslöffel, CUZZI.....	606	Anatomische Pinzette, DUEHRSEN.....	84	Arterienklemme, LOVEFACE.....	109
Abortuslöffel, WALLICH.....	607	Anatomische Pinzette, GERALD.....	86, 87	Arterienklemme, LOWER.....	120
Abortuszange, SAENGER.....	606	Anatomische Pinzette, McINDOE.....	85	Arterienklemme, MAYO-GUYON.....	122
Abortuszange, WINTER.....	606	Anatomische Pinzette, OCHSNER.....	88	Arterienklemme, MEEKER.....	119
ABRAHAM, Tonsillenfasszange.....	468	Anatomische Pinzette, POTTS-SMITH.....	81	Arterienklemme, Micro-HARTMANN.....	104
ABRAHAM, Tonsillennmesser.....	466	Anatomische Pinzette, SEMKEN.....	86	Arterienklemme, MIXTER.....	116, 119/1
Absauganlage f. Gipssäge.....	231	Anatomische Pinzette, STILLE.....	81	Arterienklemme, MIXTER-BABY.....	119/1
Absaugküretten.....	600	Anatomische Pinzette, TAYLOR.....	87	Arterienklemme, MOYNIHAN.....	120
Absaugrohr, BUIE.....	566	Anatomische Pinzette, TC.....	81	Arterienklemme, O'SHAUGNESSY.....	119/2
Absaugrohr, KLEINSASSER.....	36	Anatomische Pinzette, USA.....	81	Arterienklemme, OVERHOLT.....	114
ADAIR, Hakenzange.....	582	Anatomische Pinzette, WANGENSTEEN.....	89	Arterienklemme, OVERHOLT-GEISSENDOERFER.....	114
Adenoidektomie - Tonsillektomie DRAFFIN.....	459	Anatomische und chirurgische Pinzetten		Arterienklemme, OVERHOLT-MIXTER.....	115
Adenoidektomie - Tonsillektomie MAGAURAN.....	459	DENIS- BROWNE.....	89	Arterienklemme, PEAN.....	108, 110
ADLERKREUTZ, Gefäßspinzette.....	84	ANDERSON, Wundhaken.....	198	Arterienklemme, PENNINGTON.....	109
ADSON, anatomische Pinzette.....	81/2	ANDREW, Zungendrucker.....	452	Arterienklemme, PROVIDENCE-HOSPITAL.....	106
ADSON, Arterienklemme.....	112	ANDREW-PYNCHON, Saugrohr.....	28	Arterienklemme, ROBERTS.....	117
ADSON, Chirurgische Pinzette.....	81/2	Anestophon.....	23	Arterienklemme, ROBERTS.....	117
ADSON, Durahaken.....	329	Aneurysmaklemme, DeBAKEY-BAHNSON.....	506	Arterienklemme, ROCHESTER-CARMALT.....	109
ADSON, Halteklemme.....	298	Anlegepinzette, MEHDORN.....	362	Arterienklemme, ROCHESTER-OCHSNER.....	108
ADSON, Hohlmessselzange.....	236	Anlegezange.....	357 - 360	Arterienklemme, ROCHESTER-PEAN.....	108
ADSON, Hypophysepinzette.....	334	Anlegezange, JOHNS-HOPKINS.....	104	Arterienklemme, RUMEL.....	117
ADSON, Nadelhalter.....	211	Anlegezange, McKENZIE.....	326	Arterienklemme, SAROT.....	118
ADSON, Raspator.....	282	Anlegezange, OLIVECRONA-TOENNIS.....	326	Arterienklemme, SPENCER-WELLS.....	109
ADSON, Saugrohr.....	337	Anlegezange, RANEY.....	327	Arterienklemme, STILLE.....	122
ADSON, Wundspreizer.....	172 -174	Anlegezange, SMITHWICK.....	326	Arterienklemme, TOENNIS.....	117
ADSON-BABY, Arterienklemme.....	113	ANTRUM, Kürette.....	435	Arterienklemme, WIKSTROEM.....	117
ADSON-BABY, Wundspreizer.....	173	Antrumkürette, COAKLEY.....	449	Arterienklemme, ZENKER.....	118
ADSON-BROWN, chirurgische Pinzette.....	82	Antrumraspel, GALLAHER.....	446	Arterienklemmen, CHRISTOPHE.....	107
ADSON-Micro, anatomische Pinzette.....	81/2	Antrumraspel, WIENER.....	443	Arterienklemmen, TERRIER.....	106
ADSON-Micro, chirurgische Pinzette.....	82	Anuskop, HIRSCHMANN.....	562	ASCH, Septumrichtzange.....	449
Ahle, OBWEGESER.....	463, 463/3	Anuskop, IVES-FANSLER.....	562	Atrauma-Arterienklemme.....	492 - 527
AIR-INJECTION, Augenkanüle.....	394	Anuskop, KELLY.....	562, 563	Atrauma-Arterienklemme, DeBAKEY-MOSQUITO.....	509
ALAN-PARKS, Mastdarm-Spekula.....	561	ANVIL, Nagelspaltzange.....	613	Atrauma-Arterienklemme, DeBAKEY-PEAN.....	513
ALDERDYCE, Elevator.....	282	Aorta-Aneurysmaklemme, DeBAKEY.....	496 - 498	Atrauma-Arterienklemme, DeBAKEY-RANKIN.....	512
ALEXANDER, Biopsiezange.....	589	Aortahaken, ROSS.....	148/1	Atrauma-Bulldogklemme, DeBAKEY.....	103
ALEXANDER, Flachmeißel.....	259	Aortaklemme, DeBAKEY.....	499, 500	Atrauma-Bulldogklemme, GLOVER.....	103
ALEXANDER, Hohlmesssel.....	259	Aortaklemme, DIETRICH.....	510	Atrauma-Bulldogklemme, GREGORY.....	100
ALEXANDER, Raspator.....	276	Aortaklemme, MORRIS-DeBAKEY.....	506	Atrauma-Darmlafzange.....	539
ALEXANDER, Uterus-Biopsiezange.....	589	Aortaklemme, WEBER.....	501	Atrauma-Gefäßklemme, BECK.....	516
ALLEN, Blinddarmklemme.....	544	Aortaklemme, WYLIE.....	501/1	Atrauma-Neonataleklemme.....	523
ALLIS, Darmfasszange.....	537	Aortastanze.....	528	Atrauma-Pinzette, DeBAKEY.....	98
ALLIS-ADAIR, Darmfasszange.....	537	Approximator, BIEMER-MÜLLER.....	363	Atrauma-Pinzette, DeBAKEY TC.....	99
ALLIS-BABY, Darmfasszange.....	537	Approximator, MÜLLER.....	363	AUFRANC-COBRA, Knochenheber.....	289
ALLISON, Lungenspatel.....	489/2	ARCHER, Splitterzange.....	92	AUFRANC-COBRA, Wundhaken.....	289
ALM, Wundhaken.....	168	Armsystem.....	188	Aufreiber, KUENTSCHER.....	321
ALU, Stimmgabeln.....	403	ARRUGA, Kapselpinzette.....	391	AUFRIEHT, Nasenhaken.....	447
ALVIS, Fremdkörperkürette.....	374	ARRUGA, Lidsperrerr.....	370	AUFRIEHT, Nasenraspel.....	443
Amniotom, BEACHAM.....	586	ARRUGA, Nadelhalter.....	214	Aufsatz, BARACANI.....	472
Amputationsmesser, CATLIN.....	44	Arterienklemme, ADSON.....	112	Aufsatz, BRUNINGS.....	472
Amputationsmesser, LANGENBECK.....	44	Arterienklemme, ADSON-BABY.....	113	Aufsatz, CORDES.....	472
Amputationsmesser, LISTON.....	44	Arterienklemme, BAINBRIDGE.....	119/2	Aufsatz, FRAENKEL.....	472
Amputationsmesser, REDA.....	44	Arterienklemme, BENGOLEA.....	112	Aufsatz, KRAUSE.....	472
Amputationssäge, BIER.....	296	Arterienklemme, BIRKETT.....	116	Aufsatz, LANGE.....	472
Amputationssäge, CHARRIERE.....	296	Arterienklemme, CRAFOORD-SELLORS.....	119	Aufsatz, Reinigungspistole.....	626
Amputationssäge, SATTERLEE.....	296	Arterienklemme, CRILE.....	107	Aufsatz, SCHEINMANN.....	472
Analspreizer, SMITH-BUIE.....	561	Arterienklemme, CRILE-RANKIN.....	107	Aufsatz, SCHUMACHER.....	472
Anastomosenklemme, BECK.....	516, 520	Arterienklemme, DANDY.....	109	Aufsatz, SEIFERT.....	472
Anastomosenklemme, COOLEY.....	520/1, 520/3	Arterienklemme, DESJARDINS.....	121	Aufsatz, SLUDER-BALLENGER.....	470
Anastomosenklemme, COOLEY-DERRA.....	519	Arterienklemme, FUCHSIG.....	113	Aufsatz, Uterus-Biopsiezangen.....	591
Anastomosenklemme, DeBAKEY.....	505	Arterienklemme, GEMINI.....	115	Augenkanüle.....	394
Anastomosenklemme, DeMARTEL-WOLFFSON.....	546-547	Arterienklemme, GRAY.....	121	Augenkanüle, AIR-INJECTION.....	394
Anastomosenklemme, DERRA.....	515	Arterienklemme, GUYON.....	122	Augenkanüle, JENSEN.....	394
Anastomosenklemme, LAMBERT-KAY.....	505	Arterienklemme, HALSTED-MOSQUITO.....	105	Augenkanüle, LACRIMAL.....	394
Anastomosenklemme, POTTS.....	493	Arterienklemme, HARTMANN.....	104	Augenkanüle, McINTYRE.....	394
Anatomische Pinzette.....	81, 86	Arterienklemme, HEISS.....	112	Augenkanüle, SHEETS.....	394/2
Anatomische Pinzette, ADSON.....	81/2	Arterienklemme, JACOBSON.....	105	Augenmagnet, REDA.....	395
Anatomische Pinzette, ADSON-DeBAKEY.....	81/2	Arterienklemme, JOHNS-HOPKINS.....	120	Augenpinzetten.....	382 - 393
Anatomische Pinzette, ADSON-Micro.....	81/2	Arterienklemme, KANTROWITZ.....	119/1	Augenschere, BARRAQUER.....	75
Anatomische Pinzette, BONNEY.....	88	Arterienklemme, KELLY.....	106	Augenschere, NOYES.....	75
Anatomische Pinzette, BROPHY.....	84	Arterienklemme, KELLY-RANKIN.....	106	Augenschere, VANNAS.....	79
		Arterienklemme, KOCHER.....	108	Augenschere, WECKER.....	75
		Arterienklemme, LAHEY.....	119/2	Augenschere, WESTCOTT.....	75

Aurikelklemme, HARKEN	503
Autopsiesäge	230, 230/2
AUVARD, Scheidenspekula	576
AYER, Chlazonspinzette	393

B

BABCOCK, Darmfasszange	539
BABINSKI, Perkussionshammer	24
BABY-BURKE, Uterus-Biopsiezange	590
BABY-GOSSET, Bauchdeckenhalter	181
BABY-KOCHER, Darmklemme	540
BABY-METZENBAUM, Supercutscchere	71
BABY-OLSEN-HEGAR, Nadelhalter	212
BABY-TISCHLER, Uterus-Biopsiezange	592
BABY-WEBSTER, Nadelhalter	208
BABY-YANKAUER, Saugrohr	27
BACKHAUS, Tuchklemme	132
BACKHAUS-CLIP, Tuchklemme	132
BAILEY, Rippenkontraktor	489/1
BAILEY-BABY, Rippenkontraktor	489/1
BAILEY-GIBBON, Rippenkontraktor	489/1
BAINBRIDGE, Arterienklemme	119/2
BAINBRIDGE, Mehrzweck-Gefäßsklemme	495/1, 495/2
BAKES, Gallengangdilator	532
BALFOUR, Bauchdeckenhalter	182
BALFOUR, Haken	193
BALFOUR, Valve f. Bauchdeckenhalter	183
BALFOUR-BABY, Bauchdeckenhalter	182
BALFOUR-US, Bauchdeckenhalter	184
BALL AND SOCKET, Tuchklemme	133
BALLENGER, Schwingmesser	436
BALLENGER, Septumlevator	439
BALLENGER, Tonsillenzange	467
Bandmass	25
Bandscheibenstanze, COLCLOUGH	344/1
Bandscheibenstanze	
FERRIS-SMITH-KERRISON	344, 344/2
BANE-HARTMANN, Hohlmeisselzange	237
BARACANI, Aufsatz	472
BARBARA, Hähchen	419
BARBARA, Nadel	419
BARNHILL, Ringmeser	450
BARON, Saugrohr	336
BARR, Mastdarmspekula	559
BARRAQUER, Augenschere	75
BARRAQUER, Cilienpinzette	395
BARRAQUER, Fixationspinzette	390
BARRAQUER, Irispinzette	384
BARRAQUER, Keratoplastik-Messer	373
BARRAQUER, Lidsperrer	370
BARRAQUER, Nadelhalter	216, 217
BARRAQUER-KATZIN, Irispinzette	384
BARRAQUER-TROUTMAN, Nadelhalter	216
BARRET, Hakenzange	582
BARRON Skalpell-Griffe	38
Batteriegriff, Kaltlicht	33
Batteriegriff, Warmlicht	32
Bauch- u. Darmspatel	143/1 - 143/4
Bauch- u. Darmspatel	143/2
Bauch- u. Darmspatel, KADER	143/1
Bauch- u. Darmspatel, KÖRTE	143/1
Bauch- u. Darmspatel, KÜMMELE	143/4
Bauch- u. Darmspatel, KÜMMELE	143/4, 144
Bauch- u. Darmspatel, LERICHE	143/4
Bauchdeckenhalter, BABY-GOSSET	181
Bauchdeckenhalter, BALFOUR	182
Bauchdeckenhalter, BALFOUR-BABY	182
Bauchdeckenhalter, BALFOUR-US	184
Bauchdeckenhalter, CHARNELY	289
Bauchdeckenhalter, COLLIN	190
Bauchdeckenhalter, COLLIN-LOKTIITE	191
Bauchdeckenhalter, DeBAKEY	189/1
Bauchdeckenhalter, DENIS-BROWNE	185

Bauchdeckenhalter, DOYEN	189/1
Bauchdeckenhalter, FRAZIER	181
Bauchdeckenhalter, GELPI	189/1, 189/2
Bauchdeckenhalter, GOSSET	181
Bauchdeckenhalter, HORGAN	183
Bauchdeckenhalter, JACKSON-BURROWS	189/2
Bauchdeckenhalter, KIRSCHNER	187 - 187/1
Bauchdeckenhalter, O'SULLIVAN-O'CONNOR	181
Bauchdeckenhalter, RICARD	191
Bauchdeckenhalter, RIGBY	189/2
Bauchdeckenhalter, ROCHARD	186
BAUMGARTNER, Nadelhalter	208
BEACHAM, Amniotom	586
BECK, Anastomosenklemme	516, 520
Beckenzirkel, COLLIER	605
Beckenzirkel, COLLIN	605
Beckenzirkel, MARTIN	605
BECKER, Cystotom	375
BECKMANN, Ringmesser	450
BECKMANN, Wundspreizer	176
BECKMANN-ADSON, Wundspreizer	175
BECKMANN-EATON, Wundspreizer	176
BEEBEE, Kronenschere	68
BEER, Cilienpinzette	395
BEESON, Gipspreizer	232
Begrenzungsscheibe	230/17
Beinhautmesser	47
Beleuchtungsstab für MORGAN	565
BELLUCCI, Mikro-Ohrschere	413, 417
BENGOLEA, Arterienklemme	112
BENNETT, Knochenhebel	283
BENSAUDE, Proktoskop	565
BENSON, Pyloruspreizer	544
BERENS, Diszisionsmesser	372
BERGMANN, Hammer	272
BERGMANN, Verbandschere	69/1
BERKE, Muskelpinzette	389
BERLINER, Perkussionshammer	24
BERNHARD, Tuchklemme	133
BERRY, Drahtzange	319
Bescheidungsgerät, MOGEN	556
Bescheidungsinstrument	556
BETHUNE, Rippenschere	481
BEYER, Hohlmeisselzange	237
Biegeisen, BENDER	322
Biegehebel, LANE	325
BIEMER, Gefäßclip	361
BIEMER-MÜLLER, Approximator	363
BIER, Amputationssäge	296
BILL, Zughebel	604
BILLEAU, Ohrschlinge	409
Biopsie- und Absaugkürette	600
Biopsiekantile, MENGHINI	206
Biopsiekürette	600
Biopsiekürette, HEANY	587
Biopsiekürette, KEVORKIAN	587
Biopsiekürette, MOD. MÜNCHEN	587
Biopsiekürette, NOVAK	587
Biopsiekürette, RANDALL	587
Biopsiezange, ALEXANDER	589
Biopsiezange, BABY-TISCHLER	592
Biopsiezange, BURKE	590
Biopsiezange, EPPENDORFER	590
Biopsiezange, FAURE	588
Biopsiezange, KEVORKIAN	589, 591
Biopsiezange, KEVORKIAN-PACIFIC	592
Biopsiezange, MAXI GRASPER	593
Biopsiezange, MINI-TOWNSEND-DOWN	591
Biopsiezange, MINI-TOWNSEND-UP	591
Biopsiezange, SCHUBERT	588
Biopsiezange, SCHUMACHER	588, 589
Biopsiezange, THOMAS-GAYLOR	588
Biopsiezange, TISCHLER-BABY	592
Biopsiezange, TISCHLER-DOWN	591

Biopsiezange, TISCHLER-KEVORKIAN	592
Biopsiezange, TISCHLER-MORGAN	590, 591
Biopsiezange, TISCHLER-UP	591
Biopsiezange, TOWNSEND	591
Biopsiezange, VAN DOREN	588
Biopsiezange, WITTMER	589
Bipolare Koagulation	630 - 633
Bipolare Pinzette	630 - 632
Bipolare Scheren	634
Bipolarkabel	633
BIRCHER-GANSKE, Knochenhalte zange	246
BIRKETT, Arterienklemme	116
BISHOP-HARMAN, Irispinzette	386
BISHOP-HARMON, Spül- und Saugkanüle	394/1
BLAKE, Gallensteinzange	530/2
BLAKE, Uteruskürette	595
Blasenhalsperrer, MILLIN	553
Blasenspatel, KOCHER	552
Blasenspatel, LEGUEU	552
Blasenswundspreizer, HRYNTSCHAK	553
Blasenswundspreizer, JUDD-MASSON	552
Blasenswundspreizer, MILLIN	552
Blasenswundspreizer, THOMSON-WALKER	552
Blätter-Wechselpinzette	179
Blattosteotom, OBWEGESER	464/1
Bleiband	250
Blinddarmklemme, ALLEN	544
Blinddarmklemme, KLEINSCHMIDT	544
BLOHMKE, Tonsillenzange	467
BLOUNT, Knochenhebel	288
BLOUNT, Meniskushaken	289
BLUMENTHAL, Hohlmeisselzange	236
Blutdruckmeßgerät	5-6, 12
Blutdruckmessgeräte	5-6, 12
Blutschöpflöffel	268
Blutstillungsmeißel, PASSOW	260
BODENHAMMER, Mastdarmspekula	559
BOEHLER, Extensionsbügel	312
BOETTCHER, Tonsillenschere	59
BÖHLER, Hohlmeisselzange	238
BÖHLER, Knochenplitterzange	241
Bohrdraht, KIRSCHNER	306, 307
Bohrdrahtspender	305, 310
Bohrdrahtstütze	299
Bohrer	302
Bohrer, CRUTCHFIELD	327
Bohrer, ERRICO	299
Bohrer, McKENZIE	299
BOIES, Elevator	277
Bolzenschneider	320
BONACCOLTO, Strabismuspinzette	385
BONN, Irispinzette	387
BONNEY, Pinzette	88
BOSE, Trachealhaken	477
BOSE, Trachealspreizer	476
BOUCHERON, Ohrspekula	379
BOWMAN, Diszisionsnadel	394
BOWMAN, Lidsperrer	370
BOWMAN, Tränenkanalsonde	381
BOYNTON, Nadelhalter	214
BOYS-ALLIS, Darmaßzange	538
BOZEMANN, Nadelhalter	211
BOZEMANN, Tamponzange	138
BOZEMANN-DOUGLAS, Tamponzange	138
BRAND, Sehnenfassinstrument	293
BRAND, Sehnenhäler	294
BRAUN, Dekapitationshaken	607
BRAUN, Hakenzange	582
BRAUN, Kranioklast	607
BRAUN, Uterusdepressor	586
BRAUN-STADLER, Episotomie-Schere	64
BREAST, Wundhaken	198
BREISKY, Scheidenspekula	577
Breiten-Messinstrument	594

BRISTOW, Knochenhebel.....	290	CASTROVIEJO, Messzirkel.....	380	Clipanlegezange, PILLING.....	524, 525
BRODIE, Hohlsonde.....	199	CASTROVIEJO, Nadelhalter.....	215, 216	Clipanlegezange, SLS Clips.....	524, 525
Bronchoskopiezege, CHEVALIER-JACKSON.....	473	CASTROVIEJO, Nahtpinzette.....	392	CLOWARD, Laminektomiezege.....	342
Bronchusklemme.....	126	CASTROVIEJO, Tränenkanal dilatator.....	381	CLOWARD, Wirbelkörperspreizer.....	339
Bronchusklemme, FINOCCHIETTO.....	490	CASTROVIEJO, Zyklo dialyse spatel.....	379	CLOWARD, Wundsperr.....	178/1 - 178/4
Bronchusklemme, HARRINGTON.....	490	CASTROVIEJO-Micro, Nadelhalter.....	215	COAKLEY, Antrumkürette.....	449
Bronchusklemme, LEES.....	504	CASTROVIEJO-STANDARD, Nadelhalter.....	216	COAKLEY, Kieferhöhen trokar.....	204
Bronchusklemme, PRICE-THOMAS.....	490	CATLIN, Amputationsmesser.....	44	Coarctationsklemme, DeBAKEY.....	507
Bronchusklemme, SEMB.....	491	Cauter, WADSWORTH-TODD.....	378	Coarctationsklemme, POTTS.....	492
BROPHY, Pinzette.....	84	CAWOOD-MINNESOTA, Wangenhalter.....	451	COBB, Hohlmeissel.....	262
BROWN, Gewebepinzette.....	83	Cervicalspreizer, CLOWARD.....	178/1 - 179	COBB, Kürette.....	252
BROWN, Nadelhalter.....	209	Chalazionskürette, HEBRA.....	377	COBB, Raspator.....	280
BRUENINGS, Aufsatz.....	472	Chalazionskürette, MEYHOEFER.....	377	COBB, scharfer Löffel.....	252
BRUENINGS, Ohrspekula.....	401	Chalazionspinzette, AYER.....	393	COLCLOUGH, Bandscheibenstanze.....	344/1
BRUENINGS, Septumzange.....	425	Chalazionspinzette, DESMARRÉS.....	393	COLLER-CRILE, Arterienklemme.....	106
BRUENINGS, Tonsillennmesser.....	466	Chalazionspinzette, LAMBERT.....	393	COLLIER, Beckenzirkel.....	605
BRUENINGS, Tonsillenschnürer.....	468	CHANDLER, Elevator.....	282	COLLIER, Nadelhalter.....	208
BRUENINGS, Verlängerungsrohr.....	472	CHAPUT, Gewebefasszange.....	110	COLLIN rippenschere.....	480
BRUENINGS, Zungenspatel.....	451	CHARNLEY, Bauchdeckenhalter.....	289	COLLIN, Bauchdeckenhalter.....	190
BRUNETTI, Meissel.....	268	CHARRIERE, Amputationssäge.....	296	COLLIN, Beckenzirkel.....	605
BRÜNNINGS-LUCAS, Flachmeissel.....	260	CHEATLE, Sterilisierzange.....	227	COLLIN, Darmfasszange.....	539
BRUNNER, Darmklemme.....	543	CHELSEA-EATON, Proktoskop.....	563	COLLIN, Dynamometer.....	25
BRUNNER, Führungshohlsonde.....	221/1	CHERON, Tupferzange.....	137	COLLIN, Gewebefasszange.....	110
BRUNNER, Rippenschere.....	481	CHERRY, Laminektomiesperr.....	488	COLLIN, Hammer.....	270
BRUNNER, Wundhaken.....	167	CHEVALIER-JACKSON, Bronchoskopiezege.....	473	COLLIN, Nabelschnurklemme.....	605
BRUNS, scharfer Löffel.....	251	CHEVALIER-JACKSON, Trachealkanüle.....	479	COLLIN, Scheidenspekula.....	570
BRUNS, Verbandschere.....	70	CHILDE, Wundklammerzange.....	224	COLLIN, Sonde.....	586
Bruststütze, LEWY.....	37	Chirurgische Nadel.....	222	COLLIN, Tupferzange.....	137
Bruststütze, KLEINSASSER.....	36	Chirurgische Nadel, KEITH.....	223	COLLIN, Uterus-Fasszange.....	585
Bruststütze, NEGUS.....	459	Chirurgische Nadel, KOENIG.....	223	COLLIN, Uterussonde.....	586
BRYANT, Tupferzange.....	137	Chirurgische Pinzette.....	81/1	COLLIN, Wundhaken.....	139
BUCHWALD, Zungenspatel.....	451	Chirurgische Pinzette, ADLERKREUZ.....	84	COLLIN, Wundklammerzange.....	224
BUCK, Fremdkörperhebel.....	412	Chirurgische Pinzette, ADSON.....	81/2, 82	COLLIN, Zungenzange.....	453
BUCK, Ohrkürette.....	407	Chirurgische Pinzette, ADSON-BROWN.....	82	COLLIN-DUVAL, Fasspinzette.....	85
BUCK, Perkussionshammer.....	24	Chirurgische Pinzette, ADSON-Micro.....	82	COLLIN-HARTMANN, Wundhaken.....	141
BUCK-GRAMCKO, Knochenhebel.....	285	Chirurgische Pinzette, BONNEY.....	88	COLLIN-LOKTITE, Bauchdeckenhalter.....	191
BUJE, Rektal-Absaugrohr.....	566	Chirurgische Pinzette, BROPHY.....	88	Columella-Pinzette, COTTLE.....	448
Bulldogklemme, atrauma.....	100	Chirurgische Pinzette, BROWN.....	83	COLVER, Tonsillenfasszange.....	467
Bulldogklemme, DeBAKEY.....	103	Chirurgische Pinzette, CUSHING.....	83	CONE, Schädelstanze.....	367
Bulldogklemme, GLOVER.....	103	Chirurgische Pinzette, FERRIS-SMITH.....	85	CONVERSE, Nasenhaken.....	448
Bulldogklemme, JOHNS-HOPKINS.....	104	Chirurgische Pinzette, GERALD.....	87	CONVERSE, Nasenmesser.....	435
BÜLOW-GUNAR-HEY, Rollenklemme.....	130	Chirurgische Pinzette, GILLIES.....	86	COOLEY, Anastomosenklemme.....	520/1
BUMM, Uteruskürette.....	597, 598	Chirurgische Pinzette, LANE.....	84	COOLEY, Gefäßklemme.....	520/1 - 520/3
BUNELL, Handbohrapparat.....	299	Chirurgische Pinzette, LERCHÉ.....	83	COOLEY, Katheterklemme.....	520
BUNELL, Sehnenschnürer.....	294	Chirurgische Pinzette, McINDOE.....	85	COOLEY, Kinder-Gefäßklemmen.....	512
BUNELL, Sehnenschäler.....	292	Chirurgische Pinzette, OEHLER.....	81/1	COOLEY, Mehrzweck-Gefäßklemme.....	518 - 520
BUNGE, Exenterationslöffel.....	378	Chirurgische Pinzette, POTTS-SMITH.....	81	COOLEY, Rippensperr.....	485, 487
BUNT, Sterilisierklammer.....	227	Chirurgische Pinzette, SEMKEN.....	86	COOLEY, Saugrohr.....	28
BURCH, Fixiergabel.....	373	Chirurgische Pinzette, Standard.....	81/1	COOLEY, Wundhaken.....	148
BURKE, Uterus-Biopsiezege.....	590	Chirurgische Pinzette, STILLE.....	81/1	COOLEY-DERRA, Anastomosenklemme.....	519
BUSCH, Nabelschnurschere.....	64	Chirurgische Pinzette, STILLE-BARRAYA.....	88	COOLEY-NEONATAL, Rippensperr.....	485
BUSHE, scharfer Löffel.....	256	Chirurgische Pinzette, STRASSBURGER MODELL.....	89	COOPER, Unterbindungsnadel.....	219
		Chirurgische Pinzette, TAYLOR.....	87	CORDES, Aufsatz.....	472
		Chirurgische Pinzette, WAUGH.....	83	CORONAL-BROW, Wundhaken.....	198
		Chirurgische Schere, DEAVER.....	52	CORWIN-HEGAR, Drahtzange.....	319
		Chirurgische Schere, STANDARD.....	51	CORYLLOS, Rippenschere.....	480
		CHRISTOPHE Arterienklemmen.....	107	CORYLLOS, Wundhaken.....	166
		Cilienpinzette, BARRAQUER.....	395	COS, Mikro-Ohrzängchen.....	414
		Cilienpinzette, BEER.....	395	COTTLE, Bull dogschere.....	56
		Cilienpinzette, DOUGLAS.....	395	COTTLE, Columella-Pinzette.....	448
		Cilienpinzette, GRADLE.....	395	COTTLE, Fixierpinzette.....	270
		Cilienpinzette, LITTAUER.....	395	COTTLE, Hammer.....	413
		Cilienpinzette, REDA.....	395	COTTLE, Hauthäkchen.....	447/1, 448
		CINELLI, Septummeißel.....	441	COTTLE, Knorpelquetscher.....	440
		Circumcisionsgerät.....	556	COTTLE, Nasenhaken.....	447, 447/1
		CITELLI, Knochenstanze.....	430	COTTLE, Nasenmesser.....	435
		CLAR, Stirnlampe.....	22	COTTLE, Nasenschere.....	59
		CLARK, Lidsperr.....	370	COTTLE, Nasenspekula.....	423
		CLAUS, Tonsillennadel.....	466	COTTLE, Osteotom.....	440
		CLAUS-EICKEN, Tonsillennadel.....	466	COTTLE, Schere.....	56
		CLAYMAN, Häkchen.....	376	COTTLE, Septum elevator.....	439
		CLEVELAND, Hohlmeißelzange.....	235	COTTLE, Septummeißel.....	440
		Clipanlegezange, ETHICON.....	524, 525	COTTLE-JOSEPH, Septum elevator.....	439
		Clipanlegezange, HORIZON.....	524, 525	COTTLE-KAZANJIAN, Knochen splitterzange.....	241

C

COTTLE-NEIVERT, Hauthäkchen	448
COXETER, Metallkatheter	555
CRAFOOD-SELLORS, Arterienklemme	119
CRAFOORD, Arterienklemme	118
CRAFOORD, Lungenschere	65/2
CRAIG, Septumzange	426
CREGO, Elevator	282
CRILE, Arterienklemme	107
CRILE, Nadelhalter	213
CRILE, Nervhaken	328
CRILE, Wundhaken	140
CRILE-MURRAY, Nadelhalter	209
CRILE-RANKIN, Arterienklemme	107
CRILE-WOOD, Nadelhalter	209
CRUTCHFIELD, Bohrer	327
CRUTCHFIELD, Schädelhalter	327
CUSCO, Scheidenspekula	570, 571
CUSHING (TAYLOR), Pinzette	87
CUSHING, Bohrer	298
CUSHING, Hirnspatel	336, 369
CUSHING, Laminektomie zange	340
CUSHING, Nervenhaken	328
CUSHING, Pinzette	83, 87
CUSHING, Wundhaken	151, 152
CUZZI, Abortuslöffel	606
Cystotom, BECKER	375
Cystotom, GRAEFE	375
CZERNY, Hakenzange	584
CZERNY, Mastdarm-Spekula	559
CZERNY, Wundhaken	141

D

DALE, Gefässklemme	495
DANDY, Arterienklemme	109
DANDY, Nervenhaken	328
DARDIK, Gefässklemme	509/1
DARLING, Wundspreizer	178
Darm- u. Gewebefasszange, GREGOIRE	538
Darmfasszange, ALLIS	537
Darmfasszange, ALLIS-ADAIR	537
Darmfasszange, ALLIS-BABY	537
Darmfasszange, atrauma	539
Darmfasszange, BABCOCK	539
Darmfasszange, BOYS-ALLIS	538
Darmfasszange, COLLIN	539
Darmfasszange, DOYEN-BABY	540
Darmfasszange, DUVAL	539
Darmfasszange, JUDD-ALLIS	538
Darmfasszange, LITTLEWOOD	538
Darmfasszange, LOCKWOOD-ALLIS	538
Darmfasszange, THOMS-ALLIS	538
Darmfasszange, WILLIAMS	539
Darmklemme, BABY-KOCHER	540
Darmklemme, BRUNNER	543
Darmklemme, DeMARTEL-WOLFSON	546-547
Darmklemme, DOYEN	540
Darmklemme, FEHLAND	542
Darmklemme, HAYES	545
Darmklemme, KOCHER	540
Darmklemme, LANE	548
Darmklemme, MAYO-ROBSON	541
Darmklemme, MIKULICZ	543
Darmklemme, PAYR	549
Darmklemme, RESANO	542
Darmklemme, SCUDDER	541
Darmklemme, STONE-WATT	545
Darmschere	66
Darmspatel	143/1 - 143/4
Darmspatel, HABERER	143/3
Darmspatel, KADER	143/3
Darmspatel, KÖRTE	143/3
Darmspatel, KÜMMEL	143/4
Darmspatel, LERICHE	143/4

Darmspatel, REVERDIN	143/3
Darmspatel, RIBBON	143/1
DARTIGUES, Uterusfasszange	585
DASTOOR, Strabismuspinzette	386
DAUBENSPECK, scharfer Löffel	255
DAVIDSON (SCAPULA), Wundhaken	166
DAVIEL, Starlöffel	377
DAVIS, Duradissektor	332
DAVIS, Hirnspatel	337
DAVIS, Sterilisierpinzette	227
DAVIS-BOYLE, Mundsperrerr	455
DAVIS-BOYLE, Sperrerr	455
DAVIS-BOYLE, Zugendrücker	455
DAVIS-MEYER, Mundsperrerr	457
DAY, Häkchen	409
DE BAKEY / GARRETT, Gefässdilator	529
DE BAKEY Rippensperrerr	485/1
DE BAKEY SATINSKY Präparier- und Ligaturklemmen	504/1
DEAN, Irismesser	372
DEAN, Tonsillenschere	59
DEAVER, Präparierschere	52
DEAVER, Wundhaken	145, 146
DEAVER-GRIP, Wundhaken	146
DeBAKEY, Anastomosenklemme	505
DeBAKEY, Aorta-Aneurysmaklemme	496-498
DeBAKEY, Aortaklemme	499, 500
DeBAKEY, Atrauma-Bulldogklemme	103
DeBAKEY, Atrauma-Pinzette	98, 99
DeBAKEY, Bauchdeckenhalter	189/1
DeBAKEY, Coarclationsklemme	507
DeBAKEY, Gefässklemme	493-499
DeBAKEY, Gefässschere	61
DeBAKEY, Ligaturklemme	499-500
DeBAKEY, Mehrzweck-Gefäßklemme	495, 508, 514-517
DeBAKEY, Nadelhalter	210
DeBAKEY, Saugrohr	28
DeBAKEY, Tangentialklemme	502
DeBAKEY-BAHNSON, Aneurysmaklemme	506
DeBAKEY-DIETHRICH, Mini-Bulldogklemme	101
DeBAKEY-MIXTER, Präparier- u. Ligaturklemme	499/2
DeBAKEY-MOSQUITO, Atrauma-Arterienklemme	509
DeBAKEY-PEAN, Atrauma-Arterienklemme	513
DeBAKEY-RANKIN, Atrauma-Arterienklemme	512
DeBAKEY-RUMEL, Gefässklemme	499
DeBAKEY-SATINSKY, Tangentialklemme	502
DECKER, Rongeur	341
DEJERINE, Perkussionshammer	24
Dekapitationshaken, BRAUN	607
DeLEE, Geburtszange	602
DeLEE, Scheidenspekula	574
DeMARTEL, Führungsinstrument	330
DeMARTEL-WOLFSON, Anastomosenklemme	546-547
DeMARTEL-WOLFSON, Darmklemme	546-547
DeMARTEL-WOLFSON, Klemmenhalterung	546-547
DeMARTEL-WOLFSON, Klemmenschlusszange	546-547
DEMELE, Drahtspanninstrument	315
DEMELE, Drahtumführungsnadel	315
DENHART, Mundsperrerr	454
DENIS-BROWNE Anatomische und chirurgische Pinzetten	89
DENIS-BROWNE, Bauchdeckenhalter	185
DERF, Nadelhalter	208
Dermatom, HUMBY	50
Dermatom, SCHINK	49
Dermatom, SILVER	50
Dermatom, WATSON	50
DERRA, Anastomosenklemme	515
D'ERRICO, Nervwurzelhaken	329/2
DESCHAMPS, Unterbindungs-nadel	218
DESJARDINS, Arterienklemme	121
DESJARDINS, Gallensteinlöffel	534
DESJARDINS, Gallensteinsonde	531
DESJARDINS, Gallensteinzange	530/2

DESMARRES, Chalazionspinzette	393
DESMARRES, Wundhaken	151
DEUTSCHMANN, Starmesser	371
DEVILBISS, Schädelzange	332
Diagnostik-Besteck ECO „T“	16
Diagnostik-Besteck, RI-MINI	17
Diagnostik-Besteck, UNI III	15
DIFFENBACH, Gefässklemme	104
DIETER, Mikro-Ohrzängchen	414
DIETRICH, Aortaklemme	510
DIETRICH, Gefässschere	60
DIETRICH, Mini-Bulldogklemme	101
Dilatationsbougie, DITTEL	554
Dilatationsbougie, GUYON	554
Dilatationsbougie, VAN BUREN	554
Dilatationsbougie, OTIS	554
Dilatator, BAKES	532
Dilatator, CASTROVIEJO	381
Dilatator, DE BAKEY / GARRETT	529
Dilatator, GOODELL	581
Dilatator, HANK	580
Dilatator, HEGAR	578, 579
Dilatator, PRATT	580
Dilatator, RITTER-HALLE	433
Dilatator, WALTHER	555
Dilatator, WILDER	381
Dilatator, WYLLIE	581
Dilatator, ZIEGLER	381
DINGMANN, Elevator	463/3
DINGMANN, Knochenhalte zange	246
DINGMANN, Mundsperrerr	456
DINGMANN, Raspator	463, 463/3
DINGMANN, Sperrerr	456
Dissektor, FISCH	420
Dissektor, GORNEY	277
Dissektor, PENFIELD	333
Dissektor, ROBB	530
Diszisionsmesser, BERENS	372
Diszisionsmesser, GRAEFFE	372
Diszisionsmesser, WHEELER	373
Diszisionsmesser, ZIEGLER	373
Diszisionsnadel	374
Diszisionsnadel, BOWMAN	374
DITTEL, Dilatationsbougie	554
DIX, Fremdkörperflachmeissel	374
DIX, Fremdkörperinstrument	380
Doppelkürlette	612
Doppelöffel, VOLKMANN	257
DOUGHTY, Zungenspatel	458
DOUGLAS, Cili-pinzette	395
DOUGLAS, Kieferhöhlentroker	204
DOYEN, Hammer	271
DOYEN, Zungenspatel	451
DOYEN, Bauchdeckenhalter	189/1
DOYEN, Darmklemme	540
DOYEN, Hohlsonde	199
DOYEN, Myomeheber	594
DOYEN, Raspator	278
DOYEN, Scheidenspekula	574
DOYEN, Schere	63
DOYEN, Tuchklemme	133
DOYEN, Uterus-Polypenzange	585
DOYEN, Wundhaken	163
DOYEN-BABY, Darmklemme	540
DOYEN-JANSEN (MOLT), Mundsperrerr	454
DOYEN-STILLE, Wundhaken	457
DRAFFIN Adenoidektomie - Tonsillektomie	459
Drahtbogen, ERICH	461/2
Drahtfasszange	316, 318
Drahtkniefzange	317-320/3
Drahtsäge, OLIVECRONA	332
Drahtschere, UNIVERSAL	67
Drahtspanninstrument, DEMEL	315
Drahtspanninstrument, LOUTE	315

Drahtführungsnaedel, DEMEL	315
Drahtvalven, Bauchdeckenhalter	184
Drahtzange TC, BERRY	319
Drahtzange TC, CORWIN-HEGAR	319
Drahtzange TC, MAYO-HABERISSER	319
Dreibackenspannfutter Handgriff	300
DUBOIS, Schere	63
Duftstick	231/1
DUPLAY, Hakenzange	582
DUPLAY, Kornzange	134
DUPLEX, Stethoskop	23
DUPUY-WEISS, Tonsillennadel	466
Dura-Dissektor, DAVIS	332
Dura-Dissektor, FRAZIER	333
Dura-Dissektor, HOEN	333
Dura-Dissektor, HORSLEY	333
Dura-Dissektor, MILLIGAN	332
Dura-Dissektor, OLIVECRONA	332
Dura-Dissektor, PENFIELD	333
Dura-Dissektor, SACHS	332
Dura-Dissektor, TOENNIS	332
Dura-Dissektor, WOODSON	333
Dura-Haken	335
Dura-Haken, ADSON	329
Dura-Haken, JACOBSON	335
Dura-Messer, KOOS	335
DURANTE, Fassungszette	88
Dura-Schere, SCHMIEDEN-TAYLOR	65/1
DUVAL, Darmfassungzange	539
DUVAL, Fassungszette	85
Dynamometer, COLLIN	25

E

ECHLIN, Hohlmeisselzange	240
ECO „T“ Diagnostik-Besteck	16
EICKEN (KILLIAN), Spülkanüle	433
Ein- u. Ausschlaginstrumente	321
Elektrode, monopolar	629
Elektrodenball-Koagulation	629
Elektroden-Drahtschlinge	629
Elektroden-Koagulation	629
Elektroden-Lanzette	629
Elektroden-Nadel	629
Elektroden-Schlinge	628, 629
Elevator	280
Elevator, ALDERDYCE	282
Elevator, BALLENGER	439
Elevator, BOIES	277
Elevator, CHANDLER	282
Elevator, COTTLE	439
Elevator, COTTLE-JOSEPH	439
Elevator, CREGO	282
Elevator, DINGMANN	463, 463/3
Elevator, DINGMANN	463/3
Elevator, FREER	434, 437, 439
Elevator, HAJEK-BALLENGER	439
Elevator, HALLE	437
Elevator, HOWARTH	438
Elevator, JOSEPH	437
Elevator, KEY	282
Elevator, KILLIAN	438, 439
Elevator, MASING	437
Elevator, McDONALD	283
Elevator, MCKENTY	437
Elevator, MURPHY-LANE	283
Elevator, OBWEGESER	461/1
Elevator, PENNINGTON	438
Elevator, PIERCE	438
Elevator, ROGER	437
Elevator, SAYRE	281
Elevator, SINUS	438
Elevator, WATSON-CHEYNE	283
ELLIOT, Geburtszange	603

ELSCHING, Fixationspinzette	389
ELSCHING, Hornhautmesser	373
ELSCHING, Kapselpinzette	391
ELSCHING, Zyklodialysespatel	379
EMMETT, Fistelhäkchen	594
Endarterektomie-Stripper	202
Endemagel, STEINMANN	307, 308
Endospekuila, KOGAN	577
ENGL, Gipsäge	229
Enukleations-Löffel, WELLS	378
Episotomie-Schere, BRAUN-STADLER	64
Episotomie-Schere, WALDMANN	64
EPKER, Osteotome	464/2
EPENDORFER, Uterus-Biopsiezange	590
ERBE, Verbindungskabel	633
ERBE/SELECT, Verbindungskabel	633
ERICH, Drahtbogen	461/2
ERRICO, Bohrer	298
Ersatzklinge	49, 50
Ersatzlampchen	29, 30
Ersatzlampe	33-34
Ersatzsägeblätter	230
Ersatzleiset, HERCULES	320/1 - 320/3
ESMARCH, Gipsmesser	233
ESMARCH, Staubinde	296
ESMARCH, Verbandschere	69/2
ETHICON, Clipanlagezange	524, 525
EYES, Tonsillenschnürer	468
Exenterationslöffel, BUNGE	378
Extensionsbügel, BOEHLER	312
Extensionsbügel, KIRSCHNER	312
Extensionsbügel, KIRSCHNER US	312
Extraktionsmeißel, ROLLET	374
Extraktionshaken	322
Extraktionshaken, ARRUGA	375
Extraktionshaken, I.U.D.	593
Extraktor	322/1
Extraktor, KUENTSCHER	322
Exzentrische Begrenzungsscheibe	230/1/7

F

Face-Lift-Schere, FREEMAN	74
Face-Lift-Schere, GORNEY	73
Face-Lift-Schere, KAYE	73
Face-Lift-Schere, REES	73
Fadengabel, REDA	221
Fadengabel, Tracheotomie	475
Fadenpinzette, McPHERSON	392
Fadenpinzette, Mod. TUEBINGEN	392
Fadenpinzette, PAUFIQUE	392
Fadenschere, HEATH	66
Fadenschere, LITTAUER	66
Fadenschere, NORTHBENT	66
Fadenschere, SPENCER	66
FANSLER, Proktoskop	564
FARABEUF, Knochenhaltezeange	243
FARABEUF, Raspator	274
FARABEUF, Wundhaken	139
FARABEUF-COLLIN, Raspator	274
FARABEUF-LAMBOTTE, Knochenhaltezeange	243
FARRELL, Wattelträger	203
Fassungszette	305
Fassungszette, COLLIN-DUVAL	85
Fassungszette, DURANTE	88
Fassungszette, DUVAL	85
Fassungszette, LERCHE	83
Fassungszette, RUSS, MODELL	85
Fassungzange	316
Fassungzange, ALLIS	537
Fassungzange, ALLIS-ADAIR	537
Fassungzange, ALLIS-BABY	537
Fassungzange, BABCOCK	539
Fassungzange, BOYS-ALLIS	538

Fassungzange, COLLIN	539, 585
Fassungzange, DARTIGUES	585
Fassungzange, DOYEN	585
Fassungzange, DUVAL	539
Fassungzange, GREGOIRE	538
Fassungzange, JUDD-ALLIS	538
Fassungzange, KELLY	585
Fassungzange, LAHEY	479
Fassungzange, LITTLEWOOD	538
Fassungzange, LOCKWOOD-ALLIS	538
Fassungzange, LOVELACE	490
Fassungzange, MARTEL	110
Fassungzange, McGINVEY	568
Fassungzange, MILLIN	550, 551
Fassungzange, NOTO	585
Fassungzange, PRATT	110
Fassungzange, SERPENTINE-GRASPER	593
Fassungzange, SOMER	585
Fassungzange, WILLET-MARTEL	110
Fassungzange, WILLIAMS	539
Fassungzange, YOUNG	550
FAULKNER, Kürette	449
FAURE, Biopsiezange	588
FAURE, Peritoneumklemme	123
FAVALORO, Gefäßschere	61
FEHLAND, Darmklemme	542
FEILCHENFELD, Splitterpinzette	91
FELDHEIM, Knochenhalteklammer	249
Female Urinalschüssel	621/2
FERGUSSON, Gallensteinlöffel	533
FERGUSSON, Hämorrhoidalklemme	109
FERGUSSON, Knochenhaltezeange	243
FERGUSSON, Saugrohr	337
FERGUSSON, Schere	66
FERGUSSON-FRAZIER, Saugrohr	337
FERRIERA, Wundhaken	197
FERRIS-SMITH, Laminektomiezeange	343
FERRIS-SMITH, Pinzette	85
FERRIS-SMITH-KERRISON, Bandscheibenstanze	344, 344/2
Fertigschläger, KUENTSCHER	321
Fiberglas-Lichtträger, KLEINSASSER	36
Filtervlies f. Gipsäge	230/1/8
Finger-Goniometer	25
Fingerringzange, REDA	297
Fingerringzange, WALTON	297
Fingersäge, LANGENBECK	296
FINOCHIETTO, Bronchusklemme	490
FINOCHIETTO, Nadelhalter	211
FINOCHIETTO, Rippensperrer	482, 484
FINOCHIETTO-BABY, Rippensperrer	482
FINOCHIETTO-BURFORD, Rippensperrer	483
FINSEN, Wundhaken	168
FINSTERER, Saugrohr	28
FISCH, Dissektor	420
FISCH, feines Häkchen	335
FISCHER, Irispinzette	384
FISH, Sonde	199
FISHER, Tonsillennmesser	466
Fistelhäkchen, EMMETT	594
Fistelsonde, LOCKHART-MUMMERY	200
Fistelsonde, PRATT	563
Fixationspinzette, BARRAQUER	390
Fixationspinzette, ELSCHING	389
Fixationspinzette, GRAEFE	389
Fixationspinzette, GREEN	390
Fixationspinzette, LESTER	389
Fixiergabel, BURCH	373
Fixierpinzette, CASTROVIEJO	390
Fixierpinzette, COTTLE	410
Fixierpinzette, GRAEFE	83
Fixierpinzette, KIRBY-ARTHUR	385
Fixiervorrichtung, LEYLA	388/1
Fixiervorrichtung, ROCHARD	186

Flachbohrer, CUSHING.....	298
Flachmeissel.....	259, 264, 267
Flachmeissel, ALEXANDER.....	259
Flachmeissel, BRÜNING-S-LUCAS.....	260
Flachmeissel, Ferrozgriff.....	264
Flachmeissel, HIBBS.....	265
Flachmeissel, HÖKE.....	265
Flachmeissel, LEXER.....	263
Flachmeissel, NOVOTEX-Griff.....	264
Flachmeissel, PARTSCH.....	259
Flachmeissel, STILLE.....	260
Flachzange.....	316, 317
Flexible Fasszange, SERPENTINE-GRASPER.....	593
Flexibler Hirnspaltelhalter, LEYLA.....	368/2
Flexibler Spannarm, LEYLA.....	368/3
FOERSTER, Irispinzette.....	383
FOERSTER, Tupferzange.....	136
FOMON, Hauthäkchen.....	447/1
FOMON, Nasenhaken.....	447/1
FOMON, Nasenraspel.....	444, 445
FOMON, Nasenschere.....	58
FOMON, Raspatör.....	277
FOMON, Rhinoplastschere.....	65/1
FOMON, Septummeissel.....	441
FOX, Lupuskürette.....	608
FRAENKEL, Aufsatz.....	472
FRAENKEL, Kehlkopfpolypenzange.....	471
FRANCIS, Fremdkörpermadel.....	374
FRAZIER, Bauchdeckenhalter.....	181
FRAZIER, Dura-Dissektor.....	333
FRAZIER, Hauthäkchen.....	148/2
FRAZIER/FERGUSON, Saugrohr.....	337
FRAZIER/FERGUSON, Punktionskanüle.....	337
FREEMAN, Face-Lift-Schere.....	74
FREEMAN, Wundhaken.....	198
FREER, Elevatorium.....	437
FREER, Hauthäkchen.....	448
FREER, Nasenmesser.....	434
FREER, Septumlevator.....	437, 439
FREER, Septumhohlmeissel.....	442/1
FREER, Septummeissel.....	439
FREER, Septummesser.....	434
Fremdkörperflachmeissel, DIX.....	374
Fremdkörperhebel, BUCK.....	412
Fremdkörperhebel, QUIRE.....	412
Fremdkörperhohlmeissel, WALTON.....	374
Fremdkörperinstrument, DIX.....	380
Fremdkörperkürette, ALVIS.....	374
Fremdkörpermadel.....	374
Fremdkörpermadel, FRANCIS.....	374
Fremdkörpermadel, LA FORCE.....	374
Fremdkörperzangchen, HARTMANN.....	412
Fremdkörperzangchen, HARTMANN-HOFFMANN.....	412
Fremdkörperzangchen, HARTMANN-WULLSTEIN.....	412
Fremdkörperzangchen, STRUEMPEL.....	412
Fremdkörperzange, MATHIEU.....	553/1
FRENZEL, Nystagmusbrille.....	20
FRENZEL, Zungenspatel.....	451
FRIEDMAN, Hohlmeisselzange.....	234
FRIEDMAN, Spekula.....	577
FRITSCH, Wundhaken.....	163
FRYKHOLM, Hohlmeisselzange.....	240
FUCHS, Kapselpinzette.....	391
FUCHSIG, Arterienklemme.....	113
Führungshohlsonde, BRUNNER.....	221/1
Führungshohlsonde, KIRSCHNER.....	221
Führungshohlsonde, KOENIG.....	221/1
Führungshohlsonde, PAYR.....	221/1
Führungshohlsonde, REDA.....	221/1
Führungshohlsonde, SCHMIEDEN.....	221
Führungshohlsonde, VIENNA.....	221/1
Führungsinstrument, DeMARTEL.....	330
Führungsnadel, REDON.....	207
Führungsspiess.....	321

G

Galeahaken, YASARGIL.....	330
GALLAHER, Antrumraspel.....	446
Gallenblasenschere, THOREK.....	65/2
Gallengangdilatorator, BAKES.....	532
Gallensteinoeffel, DESJARDINS.....	534
Gallensteinoeffel, FERGUSON.....	533
Gallensteinoeffel, LUER-KOERTE.....	533
Gallensteinoeffel, MAYO.....	534
Gallensteinsonde, DESJARDINS.....	531
Gallensteinsonde, MAYO.....	534
Gallensteinsonde, MOYNIHAN.....	531
Gallensteinsonden OCHSNER.....	531
Gallensteinzange, BLAKE.....	530/2
Gallensteinzange, DESJARDINS.....	530/2
Gallensteinzange, MAYO-BLAKE.....	530/2
Gallensteinzange, MIXTER.....	530/2
GASS, Häkchen.....	376
GAUSS, Kopfschwarte.....	605
Geburtsloeffel, SELLHEIM.....	607
Geburtszange.....	602-604
Geburtszange, BARTON.....	603
Geburtszange, DeLEE.....	602
Geburtszange, ELLIOT.....	602
Geburtszange, KIELLAND.....	602
Geburtszange, KIELLAND-LUIKART.....	603
Geburtszange, LUIKART.....	603
Geburtszange, McLEAN.....	603/1
Geburtszange, McLEAN-LUIKART.....	603/1
Geburtszange, NAEGELE.....	602
Geburtszange, PIPER.....	604
Geburtszange, SIMPSON.....	602
Geburtszange, SIMPSON-BRAUN.....	602
Geburtszange, SIMPSON-LUIKART.....	603
Geburtszange, TARNIER.....	604
Geburtszange, THIERRY.....	603
Geburtszange, WRIGLEY.....	602
Gefässclip, BIEMER.....	361
Gefässclip, MEHDORN.....	362
Gefässclip, MÜLLER.....	365
Gefässdilatorator, DeBAKEY / GARRETT.....	529
Gefässdissektor, ROBB.....	530
Gefässklemme, atrauma.....	492, 495/1, 495/2, 523 - 527
Gefässklemme, BAINBRIDGE.....	495/1, 495/2
Gefässklemme, BECK.....	520
Gefässklemme, COOLEY.....	510, 518 - 522
Gefässklemme, COOLEY-DERRA.....	519
Gefässklemme, DALE.....	495
Gefässklemme, DARDIK.....	509/1
Gefässklemme, DeBAKEY.....	493 - 517
Gefässklemme, DeBAKEY-BAHNSON.....	506
Gefässklemme, DeBAKEY-BECK.....	516
Gefässklemme, DeBAKEY-MIXTER.....	499/2
Gefässklemme, DeBAKEY-MOSQUITO.....	509
Gefässklemme, DeBAKEY-PEAN.....	513
Gefässklemme, DeBAKEY-RANKIN.....	512
Gefässklemme, DeBAKEY-RUMEL.....	499
Gefässklemme, DeBAKEY-SATINSKY.....	502
Gefässklemme, DERRA.....	515
Gefässklemme, DIEFFENBACH.....	104
Gefässklemme, DIETRICH.....	510
Gefässklemme, GLOVER.....	515
Gefässklemme, GREGORY.....	517
Gefässklemme, HARKEN.....	503
Gefässklemme, JAVID.....	511
Gefässklemme, LAMBERT-KAY.....	505
Gefässklemme, LEES.....	504
Gefässklemme, LELAND-JONES.....	495
Gefässklemme, MORRIS-DeBAKEY.....	506
Gefässklemme, POTTS.....	492, 493
Gefässklemme, SATINSKY.....	491
Gefässklemme, WEBER.....	501
Gefässklemme, WYLIE.....	501/1, 501/2

Gefässmesser, KOOS.....	335
Gefässpinzette, ADLERKREUTZ.....	84
Gefässpinzette, NELSON.....	89
Gefässpinzette, STILLE-BARRAYA.....	88
Gefässpinzette, WANGENSTEEN.....	89
Gefässschere, DeBAKEY.....	61
Gefässschere, DIETRICH.....	60
Gefässschere, FAVALORO.....	61
Gefässschere, KELLY.....	61
Gefässschere, KLINKENBERG-LOTH.....	65/2
Gefässschere, POTTS-DeMARTEL.....	59
Gefässschere, POTTS-SMITH.....	61
Gefässschere, SATINSKY.....	65/2
Gefäss-Spülkanüle, SCHMID.....	338
GELPI, Bauchdeckenhalter.....	189/1, 189/2
GELPI, Haken.....	193
GEMINI, Arterienklemme.....	115
GERALD, Pinzette.....	86, 87
GERSTER, Knochenhalteklammer.....	250
GERZOG, Hammer.....	270
Gewebefässspinzette, BROWN.....	83
Gewebefässspinzette, SINGLEY.....	88
Gewebefässzange, CHAPUT.....	110
Gewebefässzange, COLLIN.....	110
Gewebefässzange, GREGOIRE.....	538
Gewebefässzange, TUFFIER.....	110
Gewicht, AUJARD.....	576
Gewicht, SCHERBAK.....	575
GIERTZ-STILLE, Rippenschere.....	481
GIGLI, Säge.....	332
GILL, Hornhautmesser.....	373
GILL, Irispinzette.....	384
GILL-ARRUGA, Kapselpinzette.....	390
GILL-HESS, Irispinzette.....	384
GILLIES, Hauthäkchen.....	448
GILLIES, Nadelhalter.....	212
GILLIES, Pinzette.....	86
GIL-VERNET, Wundhaken.....	152
Gipsabreisszange, WOLFF.....	233
Gipsmesser, ESMARCH.....	233
Gipsmesser, HOPKINS.....	233
Gipsmesser, REINER.....	233
Gipsmesser, WIGMORE.....	229
Gipssäge, elektrisch.....	230
Gipssäge, ENGEL.....	229
Gipssäge, oszillierend.....	230/10, 230/12
Gipsschere, STILLE.....	229
Gipsspreizer, BEESON.....	232
Gipsspreizer, HAGLUND-STILLE.....	232
Gipsspreizer, HENNIG.....	232
Gipsspreizer, REDA.....	232
GLOVER, Bulldogklemme.....	103
GLOVER, Mehrweckklemme.....	515
GLUCK, Rippenschere.....	480
GOELET, Wundhaken.....	141
GOLDMANN-FOX, Zahnfleischschere.....	67
GOMMEL, Pinzette.....	96
GOMMEL, Schere.....	80
Goniometer f. Finger.....	25
Goniotomiermesser, SCHEIE.....	373
GOOD, Tonsillenschere.....	59
GOODELL, Uterus-Dilatorator.....	581
GORNEY, Dissektor.....	277
GORNEY, Face-Lift-Schere.....	73
GOSSET, Bauchdeckenhalter.....	181
GOURDET, Uterusloeffel.....	599
GRADLE, Pinzette.....	395
GRADLE, Schere.....	595
GRAEFE, Cystotom.....	375
GRAEFE, Diszionsmesser.....	372
GRAEFE, Fixationspinzette.....	389
GRAEFE, Fixierpinzette.....	83
GRAEFE, Hauthäkchen.....	148/2
GRAEFE, Irispinzette.....	382

GRAEFE, Lidsperrerr	370	Häkchen, McGEE	419	Hammer, LUCAE	271
GRAEFE, Schere	56	Häkchen, O'CONNOR	375	Hammer, MEAD	271
GRAEFE, Schielhaken	375	Häkchen, ROLLET	375	Hammer, OMBREDANNE	273
GRAEFE, Starlöffel	377	Häkchen, SHAMBAUGH	419	Hammer, PARTSCH	271
GRAEFE, Starmesser	371	Häkchen, SINSKEY	376	Hammer, QUISLING	271
GRAHAM, Nervhaken	329	Häkchen, STEVENS	375	Hammer, WILLIGER	271
GRAVE, Scheidenspekula	570	Häkchen, Tracheotomie	475	Hämorrhoidal-Klemme, FERGUSSON	109
GRAY, Arterienklemme	121	Häkchen, WAGENER	409	Hämorrhoidal-Ligator	568
GREEN, Fixationspinzette	390	Häkchen, WIENER	375	Hämorrhoidal-Ligator, McGIVNEY	568
GREEN, Hornhautdissektor	374	Haken, AUFRICHT	447	Hämorrhoidal-Ligator, RUDD	568
GREEN, Muskelhaken	375	Haken, BALFOUR	193	Hämorrhoidal-Zange, HEYWOOD-SMITH	567
GREEN, Wundhaken	160	Haken, BRAUN	607	Hämorrhoidal-Zange, McGIVNEY	568
GREEN-ARMYTAGE, Uteruszange	605	Haken, COTTLE	447, 447/1	Handbohrapparat, BUNELL	299
GREGOIRE, Darm- u. Gewebefasszange	538	Haken, GELPI	193	Handbohrapparat, HUDSON	298
GREGORY Aitrauma-Bulldogklemmen	100	Haken, HARGIS	463/6	Handbohrapparat, RALK	299
GREGORY, Profundaklemme	517	Haken, HARRINGTON	193	Handbohrapparat, REDA	299
GREVEN, Ohrzängchen	414	Haken, HOFER	465	Handgriff	300
Griff, Kehlkopfspiegel	473	Haken, ITERSON	477	Handgriff Dreibackenspannlutter	300
Griff, Meissel	266	Haken, JACKSON	476	Handgriff, NABATOFF	201
Griff, Osteotome	266	Haken, KELLY	193	Handgriff, Stabinstrumente f. Tracheotomie	475
Griff, SCHERBAK	575	Haken, KIRSCHNER	185, 187	Handwaschbürste	611
Griff, Skalpell	38 - 41	Haken, LOVE	465	HANK, Uterus-Dilatator	580
Griff, Skalpell Mini	41	Haken, MASING	447	HARGIS, Raspator	463/2
Griff, Stabinstrumente, Tracheotomie	475	Haken, MASING-NEIVERT	447	HARGIS, Unterkieferhaken	463, 463/6
Griff, Uterus-Biopsiezangen	591	Haken, NAGER	465	HARGIS, Wundhaken	463
Griffe für Laryngoskope	31-32, 34	Haken, NEWS	477	HARKEN, Aurikelklemme	503
GROSS, Ohrlöffel	409	Haken, OBWEGESER	460, 461/1	HARMS, Sonde	381
GROSS-MAIER, Kornzange	134	Haken, RAMUS	461	HARRINGTON, Bronchusklemme	490
GRUBER, Ohrspekula	399	Haken, SCHOENBORN	479	HARRINGTON, Haken	193
GUILLEN, Saugräsatorium	433/1	Haken, SCOVILLE	196	HARRINGTON, Wundhaken	147
Gummiringe-Ligator, McGIVNEY	568	Haken, SMELLIE	605	HARRINGTON-PEMBERTON, Wundhaken	147
GUTHRIE, Hauthäken	148/2	Haken, SPINA-NASALIS	461	HARTMANN, Arterienklemme	104
GUYON, Arterienklemme	122	Haken, TAYLOR	196	HARTMANN, Fremdkörperzängchen	412
GUYON, Dilatationsbougie	554	Haken, TESSIER	463/3	HARTMANN, Nasenspekula	422
GUYON, Katheter-Einführungsinstrument	554	Haken, YOUNG	550	HARTMANN, Nasenzange	427
GUYON, Nierenklemme	122	Hakenzange, ADAIR	582	HARTMANN, Ohrkatheter	408
GUYTON-LUNGSGAARD, Sklerotom	373	Hakenzange, BARRET	582	HARTMANN, Ohrspekula	399
GWYNNE EVANS Tonsillen-Elevatoren	465	Hakenzange, BRAUN	582	HARTMANN, Ohrzängchen	411
Gynäkologie-Schere, DOYEN	63	Hakenzange, CZERNY	584	HARTMANN, Polypenzange	424
Gynäkologie-Schere, DUBOIS	63	Hakenzange, DUPLAY	582	HARTMANN, Stimmgabel	403
Gynäkologie-Schere, SIEBOLD	62	Hakenzange, HULKA	583	HARTMANN, Zungendrucker	452
Gynäkologie-Schere, SIMS	62	Hakenzange, IOWA	584	HARTMANN-HALLE, Nasenspekula	421
H					
HABERER, Darmspatel	143/3	Hakenzange, JACOBS	583	HARTMANN-HOFFMANN, Fremdkörperzängchen	412
HAGLUND-STILLE, Gipsspreiszer	232	Hakenzange, JARCHO	583	HARTMANN-WULLSTEIN, Fremdkörperzängchen	412
HAIHGT, Rippensperrerr	487	Hakenzange, MUSEUX	583	HASSON, Wundhaken	143
HAJEK, Hammer	273	Hakenzange, POZZI-PALMER	582	HAUGH, Mikro-Ohrzängchen	414
HAJEK, Septummeissel	442/1	Hakenzange, PRATT	584	Hauthäken, COTTLE	447/1
HAJEK-BALLENGER, Elevator	439	Hakenzange, SCHRÖDER	583, 584	Hauthäken, COTTLE-NEIVERT	478
HAJEK-KÖFLER, Stanze	429, 431	Hakenzange, SCHRÖDER (POZZI)	582	Hauthäken, FOMON	447/1
Häkchen, BARBARA	419	Hakenzange, SKENE	582	Hauthäken, FRAZIER	148/2
Häkchen, BECKER	375	Hakenzange, STAUDE-MOORE	582	Hauthäken, FREER	448
Häkchen, BOSE	477	Hakenzange, TEALE	583	Hauthäken, GILLIES	448
Häkchen, CLAYMAN	376	HALLE, scharfer Löffel	253	Hauthäken, GRAEFE	148/2
Häkchen, CONVERSE	448	HALLE, Septumelevator	437	Hauthäken, GUTHRIE	148/2
Häkchen, COTTLE	447/1	Halogenlampe	29	Hauthäken, JOSEPH	149
Häkchen, COTTLE-NEIVERT	448	HALSEY, Nadelhalter	208	Hauthäken, KILNER	608
Häkchen, DAY	409	HALSTED-MOSQUITO, Arterienklemme	105	Hauthäken, KLAPP	150
Häkchen, FISCH	335	Haltearm, LEYLA	368/1	Hauthäken, KLEINERT-KUTZ	149
Häkchen, FOMON	447/1	Halteklemme, ADSON	298	Hauthäken, LAHEY	149
Häkchen, FREER	448	Halter, Hirnspatel, LEYLA	368/4	Hauthäken, REDA	150
Häkchen, GASS	376	Halter, KALLMORGEN	573	Haut-Trephinen, KEYE	608
Häkchen, GILLIES	448	Halter, KRISTELLER	572	HAYES Knochenhebel	284
Häkchen, GRAEFE	375	Halterahmen	187	HAYES, Darmklemme	545
Häkchen, GREEN	375	Haltezange, LANE	325	HAYES, Rektum-Anastosenklemme	545
Häkchen, JAMESON	375	Hammer	270 - 273	HEANEY, Hysterektomieklammer	126
Häkchen, KILNER	447/1, 608	Hämmer DOYEN	271	HEANEY, Nadelhalter	210
Häkchen, KNAPP	375	Hammer, BERGMANN	272	HEANY, Biopsiekürette	587
Häkchen, KRAYENBÜHL	336	Hammer, COLLIN	270	HEANY, Wundhaken	164
Häkchen, KUGLEN	376	Hammer, COTTLE	273	HEANY-BALLENTINE, Hysterektomieklammer	127
Häkchen, LANGE	448	Hammer, Ferrozellgriff	272	HEATH, Fadenschere	66
Häkchen, LUCAE	409	Hammer, GERZOG	270	HEATH, Hammer	273
		Hammer, HAJEK	273	HEBRA, Chalazionskürette	377
		Hammer, HEATH	273	HEGAR, Uterus-Dilatator	578, 579
		Hammer, KIRK	270	HEIFETZ, Hirnspatel	369

HEIMING, Nierensteinzange	536
HEISS, Arterienklemme	112
HEISTER, Mundsperrer	454
Hemilaminektomiespreizer, DARLING	178
HENKE, Tonsillenelevator	465
HENLEY, Wundspreizer	170
HENNIG, Gipspreizer	232
HEPA-Filter	231/1
HEPP-SCHWEIDEL, Schere	78
HERCULES, Drahtkniefzange	320/1 - 320/3
HERRICK, Nierenstielklemme	123
HESS, Irispinzette	384
HESS, Kapselpinzette	391
HESS, Nervwurzelhaken	329/1
HEYMANN, Nasenschere	58
HEYMANN, Septumzange	425
HEYMANN-KNIGHT, Polypenzange	425
HEYWOOD-SMITH, Hämorrhoidalzange	567
HIBBS, Flachmeißel	265
HIBBS, Hohlmeißel	265
HIBBS, Osteotome	265
HIBBS, Wundhaken	164
HILL-FERGUSON, Rektal-Spekulum	560
Hirmesser	48
Hirnspatel, CUSHING	336, 369
Hirnspatel, DAVIS	337
Hirnspatel, HEIFETZ	369
Hirnspatel, OLIVECRONA	336
Hirnspatelhalter, LEYLA	368/2
HIRSCHMANN, Anuskop	562
HIRSCHMANN, Zykliodialespatel	379
Hochfrequenz-Chirurgie	628, 629
HOEN, Dura-Dissektor	333
HOESEL, Nadelhalter	213
HOFER, Wundhaken	465
Hohlmeißel	259, 264
Hohlmeißel, PARTSCH	259
Hohlmeißel, ALEXANDER	259
Hohlmeißel, COBB	262
Hohlmeißel, HIBBS	265
Hohlmeißel, KILLIAN	442/1
Hohlmeißel, LEXER	263
Hohlmeißel, LEXER-Mini	263
Hohlmeißel, NOVOTEX	264
Hohlmeißel, SMITH-PETERSEN	261
Hohlmeißel, STILLE	260
Hohlmeißel, WEST	442/1
Hohlmeißel, ZIELKE	264
Hohlmeißelzange, ADSON	236
Hohlmeißelzange, BANE-HARTMANN	237
Hohlmeißelzange, BEYER	237
Hohlmeißelzange, BLUMENTHAL	236
Hohlmeißelzange, BÖHLER	238
Hohlmeißelzange, CLEVELAND	235
Hohlmeißelzange, ECHLIN	240
Hohlmeißelzange, FRIEDMAN	234
Hohlmeißelzange, FRIEDMAN-Micro	234
Hohlmeißelzange, FRIEDMAN-Mini	234
Hohlmeißelzange, FRYKHOLM	240
Hohlmeißelzange, JANSEN	237
Hohlmeißelzange, KLEINERT-KUTZ	237
Hohlmeißelzange, LEKSELL (STILLE)	240
Hohlmeißelzange, LEMPert	237
Hohlmeißelzange, LUER	236
Hohlmeißelzange, MARQUARDT	239
Hohlmeißelzange, MAYFIELD	238
Hohlmeißelzange, MEAD	235
Hohlmeißelzange, OLIVECRONA	237
Hohlmeißelzange, RUSKIN	239
Hohlmeißelzange, SAUERBRUCH	240
Hohlmeißelzange, SCAGLIETTI	240
Hohlmeißelzange, SEMB	240
Hohlmeißelzange, SMITH-PETERSEN	238
Hohlmeißelzange, STELLBRINK	234

Hohlmeißelzange, STILLE-LUER	239
Hohlmeißelzange, STILLE-RUSKIN	239
Hohlmeißelzange, ZAUFAL-JANSEN	238
Hohlsonde	199
Hohlsonde, BRODIE	199
Hohlsonde, DOYEN	199
Hohlsonde, NELATON	199
HOHMANN, Knochenhebel	284, 285
HOHMANN-Mini, Knochenhebel	286
HOKE, Flachmeißel	265
HOKE, Osteotome	265
HOLSHER, Nervwurzelhaken	329/1
HOLZBACH, Hysterektomieklammer	126
HOLZHEIMER, Wundhaken	168
HOPKINS, Gipsmesser	233
HORGAN, Valve Bauchdeckenhalter	183
HORIZON, Clipanlagezange	524, 525
Hornhautdissektor, GREEN	374, 375
Hornhautdissektor, PATON	373
Hornhautmesser, GILL	373
Hornhautmesser, SATO	373
Hornhautmesser, TOOK	373
Hornhautschere, CASTROVIEJO	79
HORSLEY, Dura-Dissektor	333
HÖSEL, Wundhaken	167
HOUSE, Kürette	420
HOUSE, Mikro-Messsonde	420
HOUSE, Saugrohr	337/2
HOWARTH, Septumellevator	438
HRYNITSCHAK Blasenwundspreizer	553
HUBER, Universalgriff	472
HUDSON, Handbohrapparat	298
HUDSON, T-Handgriff	300
HULKA, Hakenzange	583
HUMBY, Dermatom	50
HUNTER, Splitterpinzette	91
HURD, Tonsillen-Dissektor	465
Hypophysenkürette, RAY	334
Hypophysenpinzette, ADSON	334
Hypophysenzange	341
Hysterektomieklammer, HEANEY	126
Hysterektomieklammer, HEANY-BALLENTINE	127
Hysterektomieklammer, HOLZBACH	126
Hysterektomieklammer, MAINGOT	123/1, 123/2
Hysterektomieklammer, ROGERS	127
Hysterektomieklammer, SEGOND	125
Hysterektomieklammer, SEGOND-LANDAU	125
Hysterektomieklammer, WERTHEIM	124, 128
Hysterektomieschere, WERTHEIM	63

I

I.U.D., Extraktionshaken	593
Impaktor	322/1
Inbusschlüssel	230/18
INGE, Wirbelkörperspreizer	339
INGROWN, Nagelinstrument	612/1
Injektionskanüle	36
INSTRU CARE, Instrumentenöl	635
Instrumente f. Tracheotomie	475
Instrumentenkasten	617
Instrumentenöl, INSTRU CARE	635
Intraorale Retraktoren	463/1
Inzisionschere	58
IOWA, Hakenzange	524
IOWA, Nadelführer	206
IRIS, Schere	54/2
IRIS, Supercutschere	72
Irishäkchen, O'CONNOR	375
Irishäkchen, WIENER	375
Irismesser, DEAN	372
Irismesser, KNAPP	372
Irismesser, ZIEGLER	372
Irispinzette, BARRAQUER	384

Irispinzette, BARRAQUER-KATZIN	384
Irispinzette, BISHOP-HARMAN	386
Irispinzette, BONN	387
Irispinzette, FISCHER	384
Irispinzette, FOERSTER	383
Irispinzette, GILL	384
Irispinzette, GILL-HESS	384
Irispinzette, GRAEFE	382
Irispinzette, HESS	384
Irispinzette, STEVENS	383
Irispinzette, TROUTMAN	384
Irisschere, KNAPP	55
Irisschere, LITTLER	55
Irisspatel, WECKER	378
ISRAEL, Wundhaken	162
ITERSON, Trachealhaken	477
IVES-FANSLER, Anuskop	562
IWANSON, Messgerät	227

J

JACKSON, Kehlkopfpinzette	471
JACKSON, Pinzette	471
JACKSON, Scheidenspekula	573
JACKSON, Sehnenfasszange	292
JACKSON, Trachealhaken	476
JACKSON-BURROWS, Bauchdeckenhalter	189/2
JACOBS, Hakenzange	583
JACOBSON, Arterienklemme	105
JACOBSON, Dura-Haken	335
JACOBSON, Knopfsonde	335
JACOBSON, Nadelhalter	215
JACOBSON, scharfer Löffel	257
JAEGER, Lanzennmesser	372
JAEGER, Lidplatte	371
JAMESON, Schielhaken	375
JAMESON, Strabismuspinzette	385
JANSEN, Hohlmeißelzange	237
JANSEN, Nasenpinzette	424
JANSEN, scharfer Löffel	257
JANSEN, Wundhaken	168
JANSEN-GRUENWALD, Nasenpinzette	424
JARCHO, Hakenzange	583
JAVID, Carotis-Shuntklemme	511
JENNINGS, Mundsperrer	454
JENSEN, Augenkanüle	394
JOBSON-HORNE, Watteträger	203
JOHNS-HOPKINS, Anlagezange	104
JOHNS-HOPKINS, Arterienklemme	120
JOHNS-HOPKINS, Bulldogklemme	104
JONES, Tuchklemme	132
JONES-CLIP, Tuchklemme	132
JORGENSEN, Präparierschere	53
JOSEF, Nasenmesser	434, 435
JOSEPH (LEWIS), Nasenraspel	443
JOSEPH, Hauthäkchen	149
JOSEPH, Nasenmesser	434
JOSEPH, Nasenraspel	443
JOSEPH, Nasensäge	446
JOSEPH, Raspator	277
JOSEPH, Schere	54/1
JOSEPH, Septumellevator	437
JUDD-ALLIS, Darmfasszange	538
JUDD-MASSON, Blasenwundspreizer	552
JUERS, Mikro-Ohrzangchen	414
JURASZ, Kehlkopfpolypenzange	471

K

Kabel, bipolar	633
KADER, Bauch- u. Darmspatel	143/3
KALLMORGEN, Halter	573
KALLMORGEN, Scheidenspekula	573
KALT, Kapselpinzette	391

KALT, Nadelhalter.....	214	KILLIAN, Septumelevator.....	438, 439	Knochenhaltezege, MARTIN.....	246
KALT-ARRUGA, Nadelhalter.....	214	KILLIAN, Septumschere.....	471	Knochenhaltezege, MEYER.....	248
KANE, Nabelschnurklemme.....	605	KILLIAN, Spülkanüle.....	433, 433/1	Knochenhaltezege, PATELLA.....	248
KANTROWITZ, Arterienklemme.....	119/1	KILLIAN-CLAUS, Septumhohlmeißel.....	442/1	Knochenhaltezege, REDA.....	246, 247
Kanüle, Air Injection.....	394	KILNER, Hauthäkchen.....	608	Knochenhaltezege, REILL.....	248
Kanüle, BISHOP-HARMON.....	394/1	KILNER, Nadelhalter.....	212	Knochenhaltezege, SEMB.....	243
Kanüle, EICKEN (KILLIAN).....	433	KILNER, Nasenhaken.....	447/1	Knochenhaltezege, ULRICH.....	248
Kanüle, JENSEN.....	394	KILNER, Schere.....	54/1	Knochenhaltezege, VAN BUREN.....	249
Kanüle, KILLIAN.....	433/1	KILNER, Supercutschere.....	72	Knochenhaltezege, VERBRUGGE.....	245
Kanüle, LACRIMAL.....	394	KILNER-DOUGHTY, Mundsperrerr.....	456	Knochenhebel.....	282 - 286/2, 288
Kanüle, McIntyre.....	394	Kinder-Atrauma-Gefäßklemme.....	526, 527	Knochenhebel HAYES.....	284
Kanüle, ROSEN.....	338	Kinder-Gefäßklemme.....	527	Knochenhebel LAMBOTTE.....	287
Kanüle, Sauggriff, ZÖLLNER u. WULLSTEIN.....	337/1	Kinder-Gefäßklemme, COOLEY.....	522	Knochenhebel, AUFRANC-COBRA.....	289
Kanüle, SCHMID.....	338	KIRBY-ARTHUR, Fixierpinzette.....	385	Knochenhebel, BENNETT.....	283
Kanüle, SIMCOE.....	394/2	KIRK, Hammer.....	270	Knochenhebel, BLOUNT.....	288
Kanüle, WAGENER-MOSHER.....	477	KIRSCHNER US, Extensionsbügel.....	312	Knochenhebel, BRISTOW.....	290
Kappenzange, REDA.....	615	KIRSCHNER, Bauchdeckenhalter.....	187, 187/1	Knochenhebel, BUCK-GRAMCKO.....	285
Kapselzange, MILLIN.....	550, 551	KIRSCHNER, Bohrdraht.....	306, 307	Knochenhebel, HOHMANN.....	284, 285
Kapselpinzette, ARRUGA.....	391	KIRSCHNER, Extensionsbügel.....	312	Knochenhebel, HOHMANN Mini.....	286
Kapselpinzette, CASTROVIEJO.....	391	KIRSCHNER, Führungshohlsonde.....	221	Knochenhebel, KÖNIG.....	284
Kapselpinzette, ELSCHNIG.....	391	KIRSCHNER, Haken.....	187, 187/1	Knochenhebel, LANE.....	290
Kapselpinzette, FUCHS.....	391	KIRSCHNER, Zughaken.....	313	Knochenhebel, LANE-TRETHOWAN.....	290
Kapselpinzette, GILL-ARRUGA.....	390	Klammeranlegezange, RANEY.....	327	Knochenhebel, LANGE-HOHMANN.....	286
Kapselpinzette, HESS.....	391	Klammerhalter.....	326	Knochenhebel, MURPHY-LANE.....	283
Kapselpinzette, KALT.....	391	KLAPP, Wundhaken.....	150	Knochenhebel, SMILLIE.....	291
Kapselpinzette, SCHWEIGGER.....	391	KLEINERT-KUTZ, Hauthäkchen.....	149	Knochenhebel, TAYLOR.....	291
Kapselpinzette, TERSON.....	391	KLEINERT-KUTZ, Hohlmeißel.....	237	Knochen Nagel.....	309
Kapselschere, RESANO.....	53/2	KLEINERT-KUTZ, Sehnenfassinstrument.....	294	Knochen Nagel, STEINMANN.....	307, 308
Katheter, COXETER.....	555	KLEINSASSER, Bruststütze.....	36	Knochenplattenhaltezege, LANE.....	325
Katheter, Metall.....	555	KLEINSASSER, Fiberglas-Lichtträger.....	36	Knochenraspel.....	294
Katheter, WALTHER.....	555	KLEINSASSER, Injektionskanüle.....	36	Knochenraspel, PUTTI.....	294
Kathetereinführungsinstrument, GUYON.....	554	KLEINSASSER, Rauchabsaugrohr.....	36	Knochen splitterzange, BÖHLER.....	241
Kathetereinführungzange, MAGILL.....	28	Klemme, ALLEN.....	544	Knochen splitterzange, COTTLE-KAZANJIAN.....	241
Katheterklemme, COOLEY.....	510	Klemme, HAYES.....	545	Knochen splitterzange, LISTON.....	241
KAYE, Face-Lift-Schere.....	73	Klemme, LANE.....	548	Knochen splitterzange, McINDOE.....	241
Kegel, SCHULTZE Salpingograph.....	596	Klemme, PAYR.....	549	Knochen splitterzange, RUSKIN-LISTON.....	241
Kehlkopfkanüle.....	470	Klemme, STOCKMANN.....	553/1	Knochen splitterzange, SEMB.....	242
Kehlkopf pinzette, JACKSON.....	471	Klemme, STONE-WATT.....	545	Knochen splitterzange, STAMM.....	241
Kehlkopfpolypenzange, FRAENKEL.....	471	Klemme, STRAUSS.....	553/1	Knochen splitterzange, STILLE-HORSLEY.....	242
Kehlkopfpolypenzange, JURASZ.....	471	Klemme, Vasektomie.....	553/2	Knochen splitterzange, STILLE-LISTON.....	242
Kehlkopfschere, KILLIAN.....	471	Klemmenhalterung, DeMARTEL-WOLFSON.....	546-547	Knochenstanze, CITELLI.....	430
Kehlkopfspiegel.....	473	Klemmenschließzange, DeMARTEL-WOLFSON.....	546-547	Knochenstanze, OSTROEM.....	430
Kehlkopfspiegel, MICHEL.....	423	Klemmschloss, STONE-WATT.....	545	Knopfsonde.....	199
Kehlkopfspiegel-Griff.....	473	Klinge.....	49	Knopfsonde, JACOBSON.....	335
Kehlkopfspritze.....	470	Klingenbrecher, CASTROVIEJO.....	45	Knorpelmesser, LANGENBECK.....	47
KEINSASSER, OP-Laryngoskop.....	35	Klingenbrecher, REDA.....	45	Knorpelquetscher, COTTLE.....	440
KEITH, Nadel.....	223	Klingenbrecher, TROUTMAN-CHRIS.....	45	Knopfschere, McINDOE.....	65/1
KELLY, Anuskop.....	562, 563	Klingengerferner.....	42	KNOWLES, Verbandschere.....	70
KELLY, Arterieklemme.....	106	Klinge-Skalpell.....	42	Koagulationselektrode.....	629
KELLY, Gefäßschere.....	61	KLINIKUM BERLIN, Schlauchklemme.....	129	KOCHER, Arterienklemme.....	108
KELLY, Proktoskop.....	563, 564	KLINKENBERGH-LOTH, Gefäßschere.....	65/2	KOCHER, Blasenpatel.....	552
KELLY, Uterus-Polypenzange.....	585	KNAPP, Irisschere.....	55	KOCHER, Darmklemme.....	540
KELLY, Wundhaken.....	164, 193	KNAPP, Stariöffel.....	378	KOCHER, Kropfsonde.....	479
KELLY-GRIP, Wundhaken.....	142	KNAPP, Tränensackhäkchen.....	375	KOCHER, Wundhaken.....	155, 159, 160, 163
KELLY-RANKIN, Arterienklemme.....	106	KNAPP-LUER, Trachompinzette.....	393	KOCHER-LANGENBECK, Wundhaken.....	159
Keratoplastik-Messer PAUFIQUE.....	373	KNIGHT, Septumzange.....	425	KOENIG, Führungshohlsonde.....	221/1
Keratoplastik-Messer, BARRAQUER.....	373	Knochen draht.....	314	KOENIG, Nadel.....	223
KERN, Knochenhaltezege.....	244	Knochenfeile.....	294, 612/1	KOERTE, Wundhaken.....	162
KERRISON, Stanze.....	428	Knochenhaken, VOLKMANN.....	156	Koffer, Gips säge.....	230/18
KEVORKIAN, Biopsiekürette.....	587	Knochenhalteklammer, GERSTER.....	250	KOGAN, Endoskopula.....	577
KEVORKIAN, Uterus-Biopsiezange.....	589, 591	Knochenhalteklammer, LAMBERT-LOWMAN.....	249	Komedonenquetscher, SAALFELD.....	608
KEVORKIAN-PACIFIC, Uterus-Biopsiezange.....	592	Knochenhalteklammer, LOWMAN.....	249	Komedonenquetscher, SCHAMBERG.....	608
KEY, Elevator.....	282	Knochenhalteklammer, LOWMAN-HOGLUND.....	249	Komedonenquetscher, UNNA.....	608
KEYES, Trepbine.....	608	Knochenhaltezege.....	245, 247, 249	Komedonenquetscher, WALTON.....	608
Kieferhöhlenstanze, HAJEK-KOFLER.....	429, 431	Knochenhaltezege, BIRCHER-GANSKE.....	246	Kompressorium, FELDHEIM.....	249
Kieferhöhlenstanze, KERRISON.....	428	Knochenhaltezege, DINGMANN.....	246	Komprimeter.....	295
Kieferhöhlentrakar, COAKLEY.....	204	Knochenhaltezege, FARABEU.....	243	KÖNIG, Knochenhebel.....	284
Kieferhöhlentrakar, DOUGLAS.....	204	Knochenhaltezege, FARABEU-LAMBOTTE.....	243	KÖNIG, Raspator.....	276
Kieferhöhlentrakar, LICHTWITZ.....	204	Knochenhaltezege, FERGUSSON.....	243	KÖNIG, Wundhaken.....	153
Kieferhöhlentrakar, PIERCE.....	204	Knochenhaltezege, KERN.....	244	KOOS, Duramesser.....	335
KIELLAND, Geburtszange.....	602	Knochenhaltezege, LAMBOTTE.....	244	Kopfhautklammer, RANEY.....	327
KIELLAND-LUIKART, Geburtszange.....	603	Knochenhaltezege, LANE.....	244	Kopfschwanzzange, GAUSS.....	605
KILLIAN, Hohlmeißel.....	442/1	Knochenhaltezege, LANGENBECK.....	243	Kornzange.....	135
KILLIAN, Nasenspekula.....	423	Knochenhaltezege, LEWIN.....	246	Kornzange, BRYANT.....	137

Kornzange, CHERON	137
Kornzange, COLLIN	137
Kornzange, DUPLAY	134
Kornzange, GROSS-MAIER	134
Kornzange, MAIER	134
Kornzange, PELKMANN	137
Kornzange, SIMS-MAIER	134
Kornzange, ULRICH	135
KÖRTE, Bauch- u. Darmspatel	143/3
Krampfaderbesteck, NABATOFF	201
Kranioclast, BRAUN	607
KRAUSE, Aufsatz	472
KRAUSE, Polypenschnürer	411, 433/2
KRAUSE-VOSS, Polypenschnürer	433/2
KRAYENBÜHL, Nervhäkchen	336
Kreuzschlitzschraubenzieher, LANE	324
KRISTELLER, Halter	572
KRISTELLER, Scheidenspekula	572
KROENIG, Zungenspatel	451
KRONECKER, Unterbindungsnadel	219
Kronenschere, BEEBEE	68
Kropffasszange, LAHEY	479
Kropfsonde, KOCHER	479
Kugelgelenkkloben, LEYLA	368/1
KUGLEN, Häkchen	376
KÜMMEL, Bauch- u. Darmspatel	143/2
KÜNTSCHER, Aufreiber	321
KÜNTSCHER, Extraktor	322
KÜNTSCHER, Fertigschläger	321
KÜNTSCHER, Vorbohrer	321
Kupplungskopf, LEYLA	368/1
Kürette	600, 612
Kürette, ANTRUM	435
Kürette, BLAKE	595
Kürette, BUMM	597
Kürette, COAKLEY	449
Kürette, COBB	252
Kürette, FAULKNER	449
Kürette, FOX	608
Kürette, GOURDET	599
Kürette, HEANY	584
Kürette, HEBRA	377
Kürette, HOUSE	420
Kürette, KEVORKIAN	587
Kürette, MEYHOEFER	377
Kürette, MOD, MUENCHEN	587
Kürette, NOVAK	587
Kürette, PIFFARD	608
Kürette, RANDALL	587
Kürette, RAY	334
Kürette, RECAMIER	597
Kürette, SCHRÖDER	595
Kürette, SIMS	597
Kürette, THOMAS	599

L

LA FORCE, Fremdkörpernadel	374
LA FORCE, Ringmesser	450
LA GRANGE, Supercutschere	72
LA GRANGE, Zahnfleischschere	69
LABORDE, Trachealdilatator	476
LACRIMAL, Augenkantüle	394
Ladekonus, RUDD	568
LAHEY, Hauthäkchen	149
LAHEY, Arterienklemme	120
LAHEY, Kropffasszange	479
LAHEY, Wundhaken	157
LAMBERT, Chalcionspinzette	393
LAMBERT-KAY, Anastomosenklemme	505
LAMBERT-LOWMAN, Knochenhalteklammer	249
LAMBOTTE, Knochenhebel	287
LAMBOTTE, Knochenhaltezange	244
LAMBOTTE, Osteotom	261

LAMBOTTE, Raspator	274
Laminektomie-Sperrer, CHERRY	488
Laminektomie-Spreizer, CASPAR	179, 180
Laminektomie-Spreizer, MEYERDING	180
Laminektomie-Spreizer, SCOVILLE	196
Laminektomie-Spreizer, SCOVILLE-HAVERFIELD	196
Laminektomie-Zange, CLOWARD	342
Laminektomie-Zange, CUSHING	340
Laminektomie-Zange, DECKER	341
Laminektomie-Zange, FERRIS-SMITH	343
Laminektomie-Zange, LOVE-GRUENWALD	340
Laminektomie-Zange, OLDBERG	341/1
Laminektomie-Zange, PEAPOD	341/1
Laminektomie-Zange, SCHLESINGER	342
Laminektomie-Zange, SPURLING	340
Laminektomie-Zange, WAGNER	343
LANCASTER, Lidsperrer	371
LANDAU, Scheidenspekula	577
LANDOLT, Enukektionsschere	58
LANDOLT, Tumorfasszange	341
LANE, Biegehebel	325
LANE, Knochenhaltezange	244
LANE, Knochenhebel	290
LANE, Knochenplatten-Haltezange	325
LANE, Kreuzschlitz-Schraubenzieher	324
LANE, Magenquetschklemme	548
LANE, Pinzette	84
LANE, Schraubenhaltezange	325
LANE, Schraubenzieher	323
LANE, Tuchklemme	133
LANE-TRETHOWAN, Knochenhebel	290
LANG, Tränensack-Dissektor	378
LANGE, Aufsatz	472
LANGE, Nasenflügelhäkchen	448
LANGE-HOHMANN, Knochenhebel	286
LANGENBECK, Amputationsmesser	44
LANGENBECK, Fingersäge	296
LANGENBECK, Knochenhaltezange	243
LANGENBECK, Knorpelmesser	47
LANGENBECK, Nadelhalter	213
LANGENBECK, Ohrschlinge	409
LANGENBECK, Raspator	275
LANGENBECK, Wundhaken	158, 159
LANGENBECK-GREEN, Wundhaken	153
LANGENBECK-MANNERFELT, Wundhaken mit triangle-griff	148/4
Langenmesser, JAEGER	372
LARSEN, Sehnenfasspinzette	292
Laryngoskop, MILLER	29/2-30/2
Laryngoskope Griffe	31-32, 34
Laryngoskop-Kaltlichtgriff, Batteriegriff	33
Laryngoskop-Warmlicht, Batteriegriff	32
Laryngoskop-Warmlichtgriff, Trafo-Anschluss	34
Lateralspreizer	569
LAWRENCE, Arterienklemme	119
LEBSCHKE, Sternummeißel	267
LEES, Bronchusklemme	504
LEGUÉU, Blasenspatel	552
LEKSELL (STILLE), Hohlmeißelzange	240
LELAND-JONES, Gefäßklemme	495
LEMPERT, Hohlmeißelzange	237
LEMPERT, scharfer Löffel	256
LERCHE, Fasspinzette	83
LERICHE, Arterienklemme	111
LERICHE, Bauchspatel	143/2
LERICHE, Darmspatel	143/2
LESTER, Fixationspinzette	389
LEWIN, Knochenhaltezange	246
LEWIS, Nasenraspel	443
LEWY, Bruststütze	37
LEXER, Flachmeißel	263
LEXER, Hohlmeißel	263
LEXER, Präparierschere	53
LEXER-BABY, Präparierschere	53

LEXER-Mini, Hohlmeißel	263
LEYLA, Fixiervorrichtung	368/1
LEYLA, Haltearm	368/4
LEYLA, Himpsthalter	368
LEYLA, Kugelgelenkkloben	368/4
LEYLA, Kupplungskopf	368/4
LEYLA, Retraktor-System	368 - 368/4
LICHTWITZ, Kieferhöhlentrokar	204
Lidplatte, JAEGER	371
Lidsperrer, ARRUGA	370
Lidsperrer, BARRAQUER	370
Lidsperrer, BOWMAN	370
Lidsperrer, CASTROVIEJO	371
Lidsperrer, CLARK	370
Lidsperrer, GRAEFE	370
Lidsperrer, LANCASTER	371
Lidsperrer, LIEBERMAN	371
Lidsperrer, MELLINGER	370
Lidsperrer, MUELLER	371
Lidsperrer, MURDOCK	370
Lidsperrer, PARK	371
Lidsperrer, STEVENSON	371
Lidsperrer, WEEK	370
Lidsperrer, WILLIAMS	370
LIEBERMAN, Lidsperrer	371
Ligatur-Gummiringe, MCGIVNEY	568
Ligaturklemme, DeBAKEY	499, 500
Ligaturklemme, DeBAKEY-RUMEL	499
Ligaturschere	54
Linsenhaken, STEVENS	375
Lippenhalter	453, 451
Lippenhalter, CAWOOD-MINNESOTA	451
LISTER (SINUS), Tuferzange	137
LISTER, Supercutschere	72
LISTER, Verbandschere	69/1
LISTON, Amputationsmesser	44
LISTON, Knochen splitterzange	24
LITTAUER, Cilienpinzette	395
LITTAUER, Fadenschere	66
LITTAUER, Ohrzangchen	411
LITTAUER, Polypenzange	425
LITTLE, Wundhaken	157
LITTLER, Irisschere	55
LITTLEWOOD, Darmfasszange	538
LOCKHART-MUMMERY, Fistelsonde	200
LOCKLIN, Zahnfleischschere	69
LOCKWOOD-ALLIS, Darmfasszange	538
Löffelzangchen	416
LONDON-COLLEGE, Zahnpinzette	93
LOPEZ-REINKE, Tonsillen-Dissektor	465
LORENZ, Verbandschere	70
LORNA, Tuchklemme	133
LOUTE, Drahtspanninstrument	315
LOVE, Nervwurzelhaken	329/2, 330
LOVE, Wundhaken	465
LOVE-GRUENWALD, Laminektomie zange	340
LOVELACE, Arterienklemme	109
LOVELACE, Lungenfasszange	490
LOWER, Arterienklemme	120
LOWMAN, Knochenhalteklammer	249
LOWMAN-HOGLUND, Knochenhalteklammer	249
LUBET-BARBON, Nasentamponzange	424
LUC, Septumzange	426
LUCAE, Häkchen	409
LUCAE, Hammer	271
LUCAE, Ohrpinzette	410
LUCAE, Parazentese-Nadel	408
LUCAE, Stimmgabel	404
LUER, Hohlmeißelzange	236
LUER, Trachealkanüle	479
LUER, Wundhaken	140
LUER-KOERTE, Gallensteinlöfl	533
Luftpumpe	295
LUIKART, Geburtszange	603

LUIKART-BILL, Zughebel.....	604
Lungenfasszange, LOVELACE.....	490
Lungenschere, CRAFOORD.....	65/2
Lungenspatel.....	489/2
Lungenspatel, ALLISON.....	489/2
LUNGSGAARD, Sklerotom.....	373
LUNATSCHEK, Tamponstopfer.....	465
Lupuskürlette, FOX.....	608
Lupuskürlette, PIFFARD.....	608

M

MAGAURAN Adenoidektomie - Tonsillektomie.....	459
Magen-Darmklemme, LANE.....	548
Magen-Darmklemme, MIKULICZ.....	547
Magen-Darmklemme, PAYR.....	549
MAGILL, Kathetereinführzange.....	28
MAIER, Kornzange.....	134
MAINGOT, Hysterektomieklammer.....	1231/1, 123/2
Male männlich.....	621/2
MALTZ (COTTLE), Nasenraspel.....	444
MALTZ, Nasenraspel.....	443
Mammaria, Sternum-Sperrer.....	487/1
Mandrin, RUMEL-BELMONT.....	528
MANNERFELT Wundhaken	
mit triangle-griff.....	148/3, 148/4, 148/5
männlich Male.....	621/2
Manometer.....	295
Manometer, SCHULTZE.....	596
Markraumböhrer.....	322
MARQUARD, Hohlmeisselzange.....	239
MARSCHIK, Tonsillenfasspinzette.....	468
MARTEL, Fasszange.....	110
MARTIN, Beckenzirkel.....	605
MARTIN, Cartilageschere.....	65/1
MARTIN, Knochenhaltezange.....	246
MARTIN, Uterussonde.....	586
MARTIN, Verbindungskabel.....	633
MARTIN, Wundspreizer.....	175/1
MARTINI, scharfer Löffel.....	257
MASING, Elevator.....	437
MASING, Nasenhaken.....	447
Maßband.....	25
MASSING-NEIVERT, Nasenhaken.....	447
MASSON, Nadelhalter.....	210
Maßstab, Metall.....	25
Mastdarm-Biopsiezange, TURREL.....	567
Mastdarm-Biopsiezange, YEOMAN.....	566
Mastdarm-Spekula, ALAN-PARKS.....	561
Mastdarm-Spekula, BARR.....	559
Mastdarm-Spekula, BODENHAMMER.....	559
Mastdarm-Spekula, CZERNY.....	559
Mastdarm-Spekula, MATHIEU.....	560
Mastdarm-Spekula, PRATT.....	559
Mastdarm-Spekula, SCHULZE-BERGMANN.....	560
Mastdarm-Spekula, SIMS.....	559
MASTIN, Muskelklemme.....	479
MATHIEU, Fremdkörperzange.....	553/1
MATHIEU, Mastdarmspekula.....	560
MATHIEU, Nadelhalter.....	213
MATHIEU, Wundhaken.....	141
MATHIEU-OLSEN, Nadelhalter.....	212
MATSON, Raspator.....	279
MATSON-ALEXANDER, Raspator.....	279
MAUNDER, Mundkeil.....	459
MAXI-GRASPER, Uterus-Biopsiezange.....	593
MAY, Ophthalmoskop UNI II.....	14
MAYFIELD, Hohlmeißelzange.....	238
MAYO, Gallensteinlöffel.....	534
MAYO, Gallensteinsonde.....	534
MAYO, Pinzette.....	89
MAYO, Präparierschere.....	521/1
MAYO, Sterilisierklammer.....	227
MAYO, Supercutscchere.....	71

MAYO, Zungenspatel.....	451
MAYO-ADAMS, Wundspreizer.....	171
MAYO-BLAKE, Gallensteinzange.....	530/2
MAYO-COLLINS, Wundhaken.....	141
MAYO-GUYON, Arterienklemme.....	122
MAYO-HABERISSER, Drahtzange.....	319
MAYO-HEGAR, Nadelhalter.....	209
MAYO-NOBLE, Präparierschere.....	521/1
MAYO-ROBSON, Darmklemme.....	541
MAYO-STILLE, Präparierschere.....	521/1
MAYO-STILLE, Supercutscchere.....	71
McCULLOUGH, Strabismuspinzette.....	385
McDONALD, Elevator.....	283
McGEE, Hähchen.....	419
McGEE, Mikro-Ohrzängchen.....	414
McGIVNEY, Hämorrhoidal-Ligator.....	568
McGIVNEY, Hämorrhoidal-Zange.....	568
McINDOE, Knochensplitterzange.....	241
McINDOE, Knorpelschere.....	65/1
McINDOE, Pinzette.....	85
McINTOSH, Laryngoskope.....	29-29/1, 30, 30/1
McINTOSH, Laryngoskope Sätze.....	29, 29/2-30
McINTYRE, Augenkanüle.....	394
McIVOR, Mundsperrer.....	457
McKENTY, Septumellevator.....	437, 438
McKENZIE, Anlegezange.....	326
McKENZIE, Bohrer.....	298
McKESSON, Metallrahmen.....	454/1
McLEAN, Geburtszange.....	603/1
McLEAN-LUIKART, Geburtszange.....	603/1
McLEAN-TUCKER-LUIKART, Geburtszange.....	603/1
McPHERSON, Fadenpinzette.....	392
MEAD, Hammer.....	271
MEAD, Hohlmeißelzange.....	235
Medizinbecher.....	621
Medizinlöffel.....	268, 621
MEEKER, Arterienklemme.....	119
MEHDORN, Anlegepinzette.....	362
MEHDORN, Gefäßclip.....	362
Mehrzweck-Gefäßklemme.....	520
Mehrzweck-Gefäßklemme, BAINBRIDGE.....	495/1, 495/2
Mehrzweck-Gefäßklemme, COOLEY.....	518 - 520
Mehrzweck-Gefäßklemme, DeBAKEY.....	495, 508, 514 - 517
Mehrzweck-Gefäßklemme, GLOVER.....	515
Mehrzweckschale.....	620
Meissel, BRUNETTI.....	268
Meissel, CINELLI.....	441
Meissel, FREER.....	442/1
Meissel, HAJEK.....	442/1
Meissel, KILLIAN.....	442/1
Meissel, KILLIAN-CLAUS.....	442/1
Meissel, SILVER.....	442
Meissel, WEST.....	442/1
Meisselklinge.....	266
MELLINGER, Lidsperrer.....	370
MENGHINI, Biopsiekanüle.....	206
Meniskusshaken, BLOUNT.....	289
Meniskusmesser, NEFF.....	292
Meniskusmesser, SMILLIE.....	292
MERIAM, Zahnpinzette.....	93
Messbecher.....	620
Messer, Amputation.....	44
Messer, BARRAQUER.....	373
Messer, BERENS.....	372
Messer, CASTROVIEJO.....	372
Messer, CONVERSE.....	435
Messer, COTTLE.....	435
Messer, DEAN.....	372
Messer, FREER.....	434
Messer, GRAFE.....	372
Messer, JAEGER.....	372
Messer, JOSEPH.....	434, 435
Messer, PAUFIQUE.....	373
Messer, PLESTER.....	418

Messer, POLITZER.....	408
Messer, REDA.....	435
Messer, ROSEN.....	418
Messer, SCHEIE.....	373
Messer, SCHUKNECHT.....	418
Messer, SEXTON.....	408
Messer, TABB.....	418
Messer, WHEELER.....	373
Messer, WULLSTEIN.....	418
Messer, ZIEGLER.....	372, 373
Messer, Zwischenknochen.....	44
Messgerät, IWANSON.....	227
Messinstrumente.....	594
Messschieber.....	26
Messsonde, HOUSE.....	420
Messzirkel, CASTROVIEJO.....	380
Metallkatheter.....	555
Metallkatheter, COXETER.....	555
Metallrahmen McKESSON.....	454/1
METZENBAUM Präparierschere.....	53/3, 53/4
METZENBAUM, Nadelhalter.....	211
METZENBAUM, Präparierschere.....	53 - 54
METZENBAUM, Supercutscchere.....	71
MEYER, Knochenhaltezange.....	248
MEYERDING, Laminektomiespreizer.....	180
MEYERDING, Wundhaken.....	157, 177
MEYERDING, Wundspreizer.....	180
MEYHOEFFER, Chalasionskürlette.....	377
MICHEL, Kehlkopfspiegel.....	423
MICHEL, Wundklammerpinzette.....	224
MICHEL, Wundklammerzange.....	224
Micro-FRIEDMANN, Hohlmeißelzange.....	234
Micro-HARTMANN, Arterienklemme.....	104
MICROVASCULAR, Nadelhalter.....	210
MIDDELDRORF, Wundhaken.....	160
MIDDLETON-JANSEN, Septumzange.....	430
Mikro-chirurgische Pinzette.....	94
Mikro-chirurgische Pinzette, GOMEL.....	96
Mikro-Fasszängchen, Rohrschaft.....	415
Mikro-Kanüle, ZÖLLNER u. WULLSTEIN Sauggriff.....	337/1
Mikro-Löffelzängchen, Rohrschaft.....	416
Mikro-Löffelzängchen, WULLSTEIN.....	416
Mikro-Messsonde, HOUSE.....	420
Mikro-Ohrscherechen, BELLUCCI.....	413, 417
Mikro-Ohrscherechen, SHEA.....	413
Mikro-Ohrzängchen.....	413 - 416
Mikro-Ohrzängchen, COS.....	414
Mikro-Ohrzängchen, DIETER.....	414
Mikro-Ohrzängchen, GREVEN.....	414
Mikro-Ohrzängchen, HAUGH.....	414
Mikro-Ohrzängchen, JUERS.....	414
Mikro-Ohrzängchen, McGEE.....	414
Mikro-Rohrschaftzange, REDA.....	474
Mikro-Schere, GOMEL.....	80
Mikro-Schere, HEPP-SCHIEDL.....	78
MIKULICZ, Darmklemme.....	543
MIKULICZ, Peritoneumklemme.....	123
MIKULICZ, Wundhaken.....	163
MIKULICZ-BABY, Peritoneumklemme.....	123
MILLER, Laryngoskope.....	29/2-29/3, 30/2-30/3
MILLER, Laryngoskope Sätze.....	29/2, 30/2
MILLER, Nasenraspel.....	444
MILLIGAN, Dura-Dissektor.....	332
MILLIN, Blasenperrer.....	552, 553
MILLIN, Kapselasspinzette.....	550, 551
MILLIN, Prostatafasszange.....	550, 551
Mini-Bulldogklemme, DeBAKEY-DIETRICH.....	101
Mini-Bulldogklemme, DIETRICH.....	101
MINI-LAMBOTTE, Flachmeißel.....	262
Mini-Schnellkupplungshandgriff.....	301
Mini-Skalpell.....	41
Mini-Skalpellgriffe.....	41
MINI-TOWNSEND-DOWN, Biopsiezange.....	591
MINI-TOWNSEND-UP, Biopsiezange.....	591

MIXTER, Arterienklemme.....	116
MIXTER, Gallensteinzange.....	530/2
MIXTER-BABY, Arterienklemme.....	119/1
MIXTER-DeBAKEY, Gefäßsklemme.....	499/2
MIXTER-O'SHAUGNESSY, Arterienklemme.....	119/2
Mobilisierhaken, TESSIER.....	463/3
MOD. BONN, Nahtpinzette.....	387
MOD. MÜNCHEN, Biopsiekürette.....	587
MOD. TÜBINGEN, Fadenpinzette.....	392
MOD. TÜBINGEN, Nahtpinzette.....	387
MOD. VIENNA, Nasenspekula.....	421
MOELTGEN, Winkelmesser.....	25
MOGEN, Beschneidungsgerät.....	556
MOLLISON, Wundspreizer.....	171
MOLT, Raspatorium.....	276
Monopolare Elektrode.....	629
Monopolare Pinzette.....	634
MOORFIELD, Nahtpinzette.....	392
MORGAN, Proktoskope.....	565
MORITZ-SCHMIDT, Zungenspatel.....	452
MORRIS, Wundhaken.....	164
MORRIS-DeBAKEY, Aortaklemme.....	506
MORSE, Rippensperrer.....	484
MORSE-FAVALORO, Rippensperrer.....	484
Motorfilter.....	231/1
MOYNIHAN, Arterienklemme.....	120
MOYNIHAN, Gallensteinsonde.....	531
MUELLER, Lidsperrer.....	371
Mukosamesser, FREER.....	434
MÜLLER, Approximator.....	363
MÜLLER, Gefäßclip.....	365
Mundkeil, MAUNDER.....	459
Mundsperrerr, DAVIS-BOYLE.....	455
Mundsperrerr, DAVIS-MEYER.....	457
Mundsperrerr, DENHART.....	454
Mundsperrerr, DINGMANN.....	456
Mundsperrerr, DOYEN-JANSEN (MOLT).....	454
Mundsperrerr, HEISTER.....	454
Mundsperrerr, JENNINGS.....	454
Mundsperrerr, KILNER-DOUGHTY.....	456
Mundsperrerr, McIVOR.....	457
Mundsperrerr, ROSER-KOENIG.....	454
MURDOCK, Lidsperrer.....	370
MURPHY-LANE, Elevator.....	283
MUSEUX, Hakenzange.....	583
Muskelhaken.....	267
Muskelklemme, MASTIN.....	479
Muskelpinzette, BERKE.....	389
Muskelpinzette, PRINCE.....	387
Muskelpinzette, SNELLEN.....	393
Muskelpinzette, TROUTMAN.....	389
Mutterschlüssel.....	313
MYLES, Nasenzange.....	427
Myomheber, DOYEN.....	594
Myrtenblattsonde.....	199

N

NABATOFF, Krampfadernbesteck.....	201
Nabelschnurklemme, COLLIN.....	605
Nabelschnurklemme, KANE.....	605
Nabelschnurschere, BUSCH.....	64
Nabelschnurschere, MOD. USA.....	64
Nabelschnurschere, SCHUMACHER.....	64
Nadel, BARBARA.....	419
Nadel, chirurgisch.....	222
Nadel, REVERDIN.....	220
Nadel, ROSEN.....	419
Nadeldose.....	615
Nadelelektrode, monopolar.....	628, 629
Nadelführer, IOWA.....	206
Nadelhalter, ADSON.....	211
Nadelhalter, ARRUGA.....	214
Nadelhalter, BABY-OLSEN-HEGAR.....	212

Nadelhalter, BABY-WEBSTER.....	208
Nadelhalter, BARRAQUER.....	216, 217
Nadelhalter, BARRAQUER-TROUTMAN.....	216
Nadelhalter, BAUMGARTNER.....	208
Nadelhalter, BOYNTON.....	214
Nadelhalter, BOZEMANN.....	214
Nadelhalter, BROWN.....	209
Nadelhalter, CASTROVIEJO.....	215, 216
Nadelhalter, COLLIER.....	208
Nadelhalter, CRILE.....	213
Nadelhalter, CRILE-MURRAY.....	209
Nadelhalter, CRILE-WOOD.....	209
Nadelhalter, DeBAKEY.....	210
Nadelhalter, DERF.....	208
Nadelhalter, FINOCHIETTO.....	211
Nadelhalter, GILLIES.....	212
Nadelhalter, HALSEY.....	208
Nadelhalter, HEANEY.....	210
Nadelhalter, HOESEL.....	213
Nadelhalter, JACOBSEN.....	215
Nadelhalter, KALT.....	214
Nadelhalter, KALT-ARRUGA.....	214
Nadelhalter, KILNER.....	212
Nadelhalter, LANGENBECK.....	213
Nadelhalter, MASSON.....	210
Nadelhalter, MATHIEU.....	213
Nadelhalter, MATHIEU-OLSEN.....	212
Nadelhalter, MAYO-HEGAR.....	209
Nadelhalter, METZENBAUM.....	211
Nadelhalter, MICROVASCULAR.....	210
Nadelhalter, NEIVERT.....	208
Nadelhalter, OLSEN-HEGAR.....	212
Nadelhalter, RYDER.....	210
Nadelhalter, SAROT.....	211
Nadelhalter, STEVENS.....	214
Nadelhalter, STRATTE.....	212
Nadelhalter, WANGENSTEEN.....	212
Nadelhalter, WEBSTER.....	208
Nadelkasten.....	615
NAEGELE, Geburtszange.....	603
Nagelausreisszange, RADOLF.....	297
Nageldoppelfeile.....	612/1
Nagelhautzange.....	610, 613
Nagelinstrument, INGROWN.....	612/1
Nagelschere.....	609, 610, 614
Nagel-Set.....	609
Nagelsplittinstrument.....	612/1
Nagelzange.....	609, 612/2, 613, 614
Nagelzange, ANVIL.....	613
Nagelzange, TURNBULL.....	609
NAGER, Tonsillennadel.....	466
NAGER, Wundhaken.....	465
Nahtpinzette, CASTROVIEJO.....	392
Nahtpinzette, MOD. BONN.....	387
Nahtpinzette, MOD. TUEBINGEN.....	387
Nahtpinzette, MOORFIELD.....	392
Nahtpinzette, St. MARTIN.....	392
Nasenflügelhaken, LANGE.....	448
Nasenhaken, AUFRICHT.....	447
Nasenhaken, CONVERSE.....	448
Nasenhaken, COTTLE.....	447, 447/1
Nasenhaken, FOMON.....	447/1
Nasenhaken, KILNER.....	447/1
Nasenhaken, MASING.....	447
Nasenhaken, MASING-NEIVERT.....	447
Nasenmeißel, WEST.....	442/1
Nasenmesser, CONVERSE.....	435
Nasenmesser, COTTLE.....	435
Nasenmesser, FREER.....	434
Nasenmesser, JOSEPH.....	434, 435
Nasenolive, POLITZER.....	406
Nasenpinzette, JANSEN.....	424
Nasenpinzette, JANSEN-GRUENWALD.....	424
Nasenpinzette, TROELTSCH.....	424

Nasenraspel, AUFRICHT.....	443
Nasenraspel, FOMON.....	444
Nasenraspel, JOSEPH.....	443
Nasenraspel, JOSEPH (LEWIS).....	443
Nasenraspel, LEWIS.....	443
Nasenraspel, MALTZ.....	443
Nasenraspel, MALTZ (COTTLE).....	444
Nasenraspel, MILLER.....	444
Nasenraspel, PEET.....	446
Nasenraspel, WIENER.....	443
Nasensäge, JOSEPH.....	446
Nasenschere.....	429
Nasenschere, COTTLE.....	59
Nasenschere, FOMON.....	58
Nasenschere, HEYMANN.....	58
Nasenspekula, COTTLE.....	423
Nasenspekula, HARTMANN.....	422
Nasenspekula, HARTMANN-HALLE.....	421
Nasenspekula, KILLIAN.....	423
Nasenspekula, MOD. VIENNA.....	421
Nasenspekula, REDA.....	423
Nasenspekula, THUDICHUM.....	421
Nasenspekula, TIECK-HALLE.....	423
Nasenspekula, VOLTOLINI.....	421
Nasentamponzange, LUBET-BARBON.....	424
Nasentamponzange, WESTMACOTT.....	424
Nasenzange.....	431
Nasenzange, CAPLAN.....	428
Nasenzange, CRAIG.....	426
Nasenzange, HARTMANN.....	427
Nasenzange, MIDDLETON-JANSEN.....	430
Nasenzange, MYLES.....	427
Nasenzange, RUBIN.....	428
Nasenzange, SCHMEDEN.....	427
Nasenzange, STRUYCKEN.....	427
Nasenzange, TAKAHASHI.....	427
Nasenzange, WATSON-WILLIAMS.....	428
Nasenzange, WEIL-BLAKESLEY.....	426
NEFF, Meniskusmesser.....	292
NEGUS, Bruststütze.....	459
NEGUS, Tonsillenzange.....	467
NEIVERT, Nadelhalter.....	208
NEIVERT-ANDERSON, Septummeißel.....	442
NELATON, Hohlsonde.....	199
NELSON, Gefäßspinzette.....	89
NELSON, Trokar.....	205
NEONATAL, Atrauamaklemme.....	523
Neonatal-Gefäßsklemme, CASTANEDA.....	527
Nervhaken, KRAYENBUEHL.....	336
Nervhaken, ADSON.....	329
Nervhaken, CRILE.....	328
Nervhaken, CUSHING.....	328
Nervhaken, DANDY.....	328
Nervhaken, DeMARTEL.....	330
Nervhaken, D'ERRICO.....	329/2
Nervhaken, GRAHAM.....	329
Nervhaken, HESS.....	329/1
Nervhaken, HOLSHER.....	329/1
Nervhaken, LOVE.....	329/2, 330
Nervhaken, SACHS.....	329
Nervhaken, SCOVILLE.....	329/1, 330
Nervhaken, SMITHWICK.....	329
Nervhaken, YASARGIL.....	330
Nervrädchen, WARTENBERG.....	25
Nerwurzelnhaken, D'ERRICO.....	329/2
Nerwurzelnhaken, HESS.....	329/1
Nerwurzelnhaken, LOVE.....	329/2, 330
Nerwurzelnhaken, SCOVILLE.....	329/1, 330
Neuro-chirurgische Schere.....	65
Neuro-chirurgische Schere, STRULLY.....	65
NEWS, Trachealhaken.....	477
Nierenklemme, GUYON.....	122
Nierenerschle.....	619
Nierensteinklemme, HERRICK.....	123

Nierensteinzange, HEIMING	536
Nierensteinzange, RANDALL	535
Nierenstielklemme, WERTHEIM-CULLEN	125
NISSEN, Arterienklemme	113
NORFOLK/NORWICH, Wundspreizer	172
NORTHBENT, Fadenschere	66
NOTO, Uterus-Polypenzange	585
NOVAK, Biopsiekürette	587
NOVOTEX, Hohlmeißel	264
NOYES, Augenschere	75
NOYES, Polypenzange	425
Nystagnusbrille, FRENZEL	20

O

Obduktions-Besteck	269
Oberarmmanschette	295
Oberschenkelmanschette	295
OBWEGESER, Ahle	463, 463/3
OBWEGESER, Blattosteotom	464/1
OBWEGESER, Elevator	461/1
OBWEGESER, Osteotom	463, 464/1
OBWEGESER, Raspator	462
OBWEGESER, Wundhaken	460, 461/1
OCHSNER Gallensteinsonden	531
OCHSNER, Trokar	205
O'CONNOR, Irisakähen	375
OEHLER, chirurgische Pinzette	81/1
Ohrhebel, ZAUFAL	409
Ohrhebel, ZAUFAL-JANSEN	409
Ohrkatheter, HARTMANN	408
Ohrkürette, BUCK	407
Ohrlöffel, GROSS	409
Ohrmesser, POLITZER	408
Ohrmesser, SEXTON	408
Ohrpinzette JANSEN	424
Ohrpinzette, JANSEN-GRUENWALD	424
Ohrpinzette, LUCAE	410
Ohrpinzette, TROELTSCH	410, 424
Ohrpinzette, WILDE (TROELTSCH)	410
Ohrscherchen, BELLUCCI	413
Ohrscherchen, SHEA	413
Ohrscherchen, WULLSTEIN	417
Ohrschlinge, BILLEAU	409
Ohrschlinge, LANGENBECK	409
Ohrschlinge, SHAPLEIGH	410
Ohrspekula, BOUCHERON	399
Ohrspekula, BRUENINGS	401
Ohrspekula, GRUBER	399
Ohrspekula, HARTMANN	399
Ohrspekula, POLITZER	399
Ohrspekula, SIEGLE	402
Ohrspekula, TOYNBEE	399
Ohrspekulahalter, LEYLA	368/3
Ohrspritze, REINER	406
Ohrzängchen	413-416
Ohrzängchen, COS	414
Ohrzängchen, GREVEN	414
Ohrzängchen, HARTMANN	411, 412, 424
Ohrzängchen, HARTMANN-HOFFMANN	412
Ohrzängchen, HARTMANN-WULLSTEIN	412
Ohrzängchen, HAUGH	414
Ohrzängchen, HEYMANN-KNIGHT	425
Ohrzängchen, JUERS	414
Ohrzängchen, LITTAUER	411, 425
Ohrzängchen, LUBET-BARBON	424
Ohrzängchen, McGEE	414
Ohrzängchen, NOYES	425
Ohrzängchen, STRUEMPEL	412
Ohrzängchen, TILLEY	411
Ohrzängchen, WESTMACOTT	424
Ohrzängchen, WULLSTEIN	416
OLDBERG, Laminektomie-Zange	341/1
OLIVECRONA, Drahtsäge	332

OLIVECRONA, Dura-Dissektor	332
OLIVECRONA, Himspatel	336
OLIVECRONA, Hohlmeißelzange	237
OLIVECRONA-TOENNIS, Anlegezange	326
OLLIER, Wundhaken	162
OLSEN-HEGAR, Nadelhalter	212
OMBREDANNE (JACKSON), Tuchklemmen	133
OMBREDANNE, Pfieme	304
OMBREDANNE, Hammer	273
Ophthalmologie-Schere, GRADLE	57
Ophthalmologie-Schere, STEVENS	58
Ophthalmoskop, MAY UNI II	14
OP-Laryngoskop, KLEINSASSER	35
Organ- und Gewebefaßzange, atrauma	111
Organmesser	48
Oscillierende Gipsäge	230/10, 230/12
Oscillierende Gipsäge m. Stababsauger	231
Osteotom	259, 464
Osteotom, COTTE	440
Osteotom, EPKER	464/2
Osteotom, FOMON	441
Osteotom, HIBBS	265
Osteotom, HOKE	265
Osteotom, LAMBOTTE	261
Osteotom, LEXER	263
Osteotom, MINI-LAMBOTTE	262
Osteotom, NEIVERT-ANDERSON	442
Osteotom, OBWEGESER	463, 464/1
Osteotom, RUBIN	440
Osteotom, SHEEHAN	441
Osteotom, SMITH-PETERSEN	261
Osteotom, STILLE	260
Osteotom, WEST	442/1
Osteotomklänge	266
OSTROEM, Knochenstanze	430
O'SULLIVAN-O'CONNOR, Bauchdeckenhalter	181
O'SULLIVAN-O'CONNOR, Scheidenspekula	576
Oszillierende Gipsäge	230/10, 230/12
OTIS Dilatationsbougies	554
OTIS, Urethrotom	553
Otoskop Diagnostik-Besteck, UNI I	13
OVERHOLT, Arterienklemme	114
OVERHOLT-BABY, Arterienklemme	114
OVERHOLT-GEISENDOERFER, Arterienklemme	114
OVERHOLT-MIXTER, Arterienklemme	115

P

PALMER-POZZI, Hakenzange	582
Parametriummklemme, REDA	128/1
Parametriumschere TC	63
Parazentesenadel, LUCAE	408
Parazentesenadel, POLITZER	408
PARK, Lidsperrerr	371
PARKER, Wundhaken	139
PARKER-LANGENBECK, Wundhaken	141
PARTSCH, Flachmeißel	259
PARTSCH, Hammer	271
PARTSCH, Hohlmeißel	259
PASSOW, Blutstillungsmeißel	260
PATELLA, Knochenhaltezange	248
PATON, Hornhautdissektor	373
PAUFIQUE, Fadenpinzette	392
PAUFIQUE, Keratoplastik-Messer	373
PAYR, Darmquetschklemme	549
PAYR, Führungshohlsonde	221/1
PAYR-BABY, Darmquetschklemme	549
PEAN, Arterienklemme	108, 110
PEAPOD, Rongeur	341/1
PECK-JOSEPH, Präparierschere	74
PEDERSON, Scheidenspekula	570
PEERS, Tuchklemme	132
PEET, Nasenraspel	446
PEET, Splitterzange	92

PELMANN, Tupferzange	137
Pelvis-Haken, St. MARKS	165
PENFIELD, Dissektor	333
Penisklemme, STOCKMANN	553/1
Penisklemme, STRAUSS	553/1
PENNINGTON, Arterienklemme	109
PENNINGTON, Septumlevator	438
PERCY, Retraktor	296
Perforatorie, SMELLIE	607
Peripheral-Gefäßsklemme, DeBAKEY	494
Peripheral-Gefäßsklemme, LELAND-JONES	494
Peritoneumklemme, FAURE	123
Peritoneumklemme, MIKULICZ	123
Peritoneumklemme, PHANEUF	123
PERKINS, Wundspreizer	168
Perkussionshammer, BABINSKY	24
Perkussionshammer, BERLINER	24
Perkussionshammer, BUCK	24
Perkussionshammer, TAYLOR	24
Perkussionshammer, TROEMNER	24
PERTHES, Pfieme	304
PESTALOZZA, Abortuskürette	606
PETRI, Schale	620
Pfieme	304
Pfieme, PERTHES	304
Pfieme, OMBREDANNE	304
Phalagenmesser	44
PHANEUF, Peritoneumklemme	123
PIERCE, Kieferhöhlentrotkar	204
PIERCE, Septumlevator	438
PIFFARD, Lupuskürette	608
PILLING, Clipanlagezange	524, 525
PINARD, Stethoskop	23
Pinzette, ADLERKREUTZ	84
Pinzette, ADSON	81/2, 82, 334
Pinzette, ADSON-BROWN	82
Pinzette, ADSON-DeBAKEY	81/2
Pinzette, anatomisch	81
Pinzette, ARRUGA	391
Pinzette, atrauma	96, 99
Pinzette, AYER	393
Pinzette, BARRAQUER	384, 390, 395
Pinzette, BARRAQUER-KATZIN	384
Pinzette, BEER	395
Pinzette, BERKE	389
Pinzette, bipolar	630-632
Pinzette, BISHOP-HARMAN	386
Pinzette, BONACCOLTO	385
Pinzette, BONNEY	88
Pinzette, BROPHY	84
Pinzette, BROWN	83
Pinzette, CARMALT	91
Pinzette, CASTROVIEJO	390-392
Pinzette, COLLIN-DUVAL	85
Pinzette, COTTE	410
Pinzette, CUSHING	83
Pinzette, CUSHING-TAYLOR	87
Pinzette, DASTOOR	386
Pinzette, DAVIS	227
Pinzette, DeBAKEY	96, 99
Pinzette, DESMARRRES	393
Pinzette, DOUGLAS	395
Pinzette, DUEHRSEN	84
Pinzette, DURANTE	88
Pinzette, DUVAL	85
Pinzette, ELSCHNIG	389, 391
Pinzette, FEILCHENFELD	91
Pinzette, FERRIS-SMITH	85
Pinzette, FISCHER	384
Pinzette, FOERSTER	383
Pinzette, FUCHS	391
Pinzette, GERALD	85, 86
Pinzette, GILL	384
Pinzette, GILL-ARRUGA	390

Pinzette, GILL-HESS.....	384
Pinzette, GILLIES.....	86
Pinzette, GOMEL.....	96
Pinzette, GRADLE.....	395
Pinzette, GRAEFE.....	83, 382, 389
Pinzette, GREEN.....	390
Pinzette, HESS.....	384, 391
Pinzette, HUNT.....	97
Pinzette, HUNTER.....	91
Pinzette, JACKSON.....	471
Pinzette, JAMESON.....	385
Pinzette, JANSEN.....	424
Pinzette, JANSEN-GRUENWALD.....	424
Pinzette, KALT.....	391
Pinzette, KIRBY-ARTHUR.....	385
Pinzette, KNAPP-LUER.....	393
Pinzette, LANE.....	84
Pinzette, LERCHE.....	83
Pinzette, LESTER.....	389
Pinzette, LITTAUER.....	395
Pinzette, LONDON-COLLEGE.....	93
Pinzette, MAYO.....	89
Pinzette, McCULLOUGH.....	385
Pinzette, McINDOE.....	85
Pinzette, MCPHERSON.....	392
Pinzette, MERIAM.....	93
Pinzette, Mikrochirurgie.....	94, 96
Pinzette, MOD. BONN.....	387
Pinzette, MOD. TÜBINGEN.....	387, 392
Pinzette, Monopolar.....	634
Pinzette, MOORFIELD.....	392
Pinzette, NELSON.....	89
Pinzette, OCHSNER.....	88
Pinzette, OEHLER.....	81/1
Pinzette, PAUFIQUE.....	392
Pinzette, POTTS-SMITH.....	81
Pinzette, PRINCE.....	387
Pinzette, REDA.....	395
Pinzette, SCHWEIGGER.....	391
Pinzette, SEMKEN.....	86
Pinzette, SINGLEY.....	88
Pinzette, SNELLEN.....	393
Pinzette, St. MARTIN.....	392
Pinzette, STEVENS.....	383
Pinzette, STILLE.....	81
Pinzette, STILLE-BARRAYA.....	88
Pinzette, STRASSBURGER MODELL.....	89
Pinzette, TAYLOR.....	87
Pinzette, TERSON.....	391
Pinzette, TROELTSCH.....	424
Pinzette, TROUTMAN.....	389
Pinzette, Tumor.....	97
Pinzette, Uhrmacher.....	90
Pinzette, Ultra-light.....	95
Pinzette, USA.....	81/1
Pinzette, WAGENSTEEN.....	89
Pinzette, WAUGH.....	83
Pinzette, WILDE (TROELTSCH).....	410
Pinzette, YASARGIL.....	97
Pinzette, LUCAE.....	410
Pinzetten, RESANO.....	85
PIPER, Geburtszange.....	604
Pistole f. Reinigung.....	626
Plastik-Hammer.....	271
Plazentabecken.....	621/1
PLESTER, Messer.....	418
PLESTER, Saugrohr.....	338
PLESTER, Wundspreizer.....	171
POLITZER, Gummibirne.....	406
POLITZER, Luftdusche.....	406
POLITZER, Nasenolive.....	406
POLITZER, Ohrmesser.....	408
POLITZER, Ohrspekula.....	399
POLITZER, Parazentese-Nadel.....	408

Polster f. Oberarm- u. Oberschenkelmanschette.....	295
Polypenschlinge.....	411
Polypenschürer, KRAUSE.....	411, 433/2
Polypenschürer, KRAUSE-VOSS.....	433/2
Polypenschürer, WILDE.....	411, 433/2
Polypenzange, BRUENINGS.....	425
Polypenzange, HARTMANN.....	424
Polypenzange, HEYMANN.....	425
Polypenzange, HEYMANN-KNIGHT.....	425
Polypenzange, JURASZ.....	471
Polypenzange, KNIGHT.....	425
Polypenzange, LITTAUER.....	425
Polypenzange, LUBET-BARBON.....	424
Polypenzange, NOYES.....	425
Polypenzange, WESTMACOTT.....	424
POOLE, Saugrohr.....	27
POST MORTEM.....	269
POTTS, Anastomosen-Klemme.....	493
POTTS, Coarctations-Klemme.....	492
POTTS, Gefäßsklemme.....	492, 493
POTTS-DeMARTEL, Gefäßsschere.....	59
POTTS-SMITH, anatomische Pinzette.....	81
POTTS-SMITH, chirurgische Pinzette.....	81
POTTS-SMITH, Gefäßsschere.....	61
POZZI-PALMER, Hakenzange.....	582
Präparier- und Ligaturklemmen.....	128/2
Präparier- und Ligaturklemmen.....	504/1
Präparierschere.....	52
Präparierschere, DEAVER.....	52
Präparierschere, JORGENSEN.....	53
Präparierschere, LEXER.....	53
Präparierschere, LEXER-BABY.....	53
Präparierschere, MAYO.....	52/1
Präparierschere, MAYO-NOBLE.....	52/1
Präparierschere, MAYO-STILLE.....	52/1
Präparierschere, METZENBAUM.....	53/1
Präparierschere, METZENBAUM FINO.....	53/1
Präparierschere, PECK-JOSEPH.....	74
Präparierschere, TOENNIS-ADSON.....	65
Präparierschere, WELLER.....	53/2
Präparierschere.....	52, 52/1, 53
Präparierschere, METZENBAUM.....	53/3, 53/4
PRATT, Dilator.....	580
PRATT, Fasszange.....	110
PRATT, Fistelsonde.....	563
PRATT, Hakenzange.....	584
PRATT, Mastdarm-Spekula.....	559
PRATT, Uterus-Dilator.....	580
PRECISA, Blutdruckmessgerät.....	9
PRESBYTERIAN, Schlauchklemme.....	129
PRICE-THOMAS, Bronchusklemme.....	490
PRINCE, Muskelpinzette.....	387
PRINCE, Tonsillenschere.....	59
PROBE AND PACKER.....	612
Profundaklemme, GREGORY.....	517
Proktoskop, BENSAUDE.....	565
Proktoskop, CHELSEA-EATON.....	563
Proktoskop, FANSLER.....	564
Proktoskop, HIRSCHMANN.....	563
Proktoskop, IVES-FANSLER.....	563
Proktoskop, KELLY.....	563, 564
Proktoskope MORGAN.....	565
Prostatafasszange, MILLIN.....	550, 551
Prostatahaken, YOUNG.....	550
PROVIDENCE-HOSPITAL, Arterienklemme.....	106
Pumpe f. Komprimeter.....	295
Punktionskanüle, FRAZIER.....	337
PUTTI, Knochenraspel.....	294
Pylorusspreizer, BENSON.....	544

QUERVAIN, Elevator.....	275
-------------------------	-----

QUINBY, Zahnfleischschere.....	67
QUIRE, Fremdkörperhebel.....	412
QUISLING, Hammer.....	271

R	
Rachiotom.....	267
RADOLF, Nagelausschere.....	297
RAGNELL, Wundhaken.....	140
Rahmen, DENIS-BROWNE, Bauchdeckenhalter.....	185
Rahmen, KIRSCHNER, Bauchdeckenhalter.....	187 - 187/1
Rahmen, O'SULLIVAN-O'CONNOR.....	576
RALK, Handbohrapparat.....	299
RAMPLEY, Tupferzange.....	136
RAMUS, Wundhaken.....	461
RANDALL, Biopsiekürette.....	587
RANDALL, Nierensteinzange.....	535
RANEY, Klammeranlegezange.....	327
RANEY, Kopfhautklammer.....	327
Rasierklingen.....	45
Rasiermesser.....	49
Rasporatorium.....	279
Rasporatorium, ADSON.....	282
Rasporatorium, ALEXANDER.....	276
Rasporatorium, COBB.....	280
Rasporatorium, DINGMANN.....	463, 463/3
Rasporatorium, DOYEN.....	278
Rasporatorium, FARABEUF.....	274
Rasporatorium, FARABEUF-COLLIN.....	274
Rasporatorium, FOMON.....	277
Rasporatorium, GUILLEN.....	433/1
Rasporatorium, HARGIS.....	463/2
Rasporatorium, JOSEPH.....	277
Rasporatorium, KÖNIG.....	276
Rasporatorium, LAMBOTTE.....	274
Rasporatorium, LANGENBECK.....	275
Rasporatorium, MATSON.....	279
Rasporatorium, MATSON-ALEXANDER.....	279
Rasporatorium, MOLT.....	276
Rasporatorium, MOLT.....	276
Rasporatorium, OBWEGESER.....	462
Rasporatorium, QUERVAIN.....	275
Rasporatorium, SEBILEAU.....	275
Rasporatorium, SEDILLOT.....	274, 275
Rasporatorium, SELDIN.....	277
Rasporatorium, SEMB.....	278
Rasporatorium, WILLIGER.....	276
Raspel, AUFRIEHT.....	443
Raspel, FOMON.....	444, 445
Raspel, GALLAHER.....	446
Raspel, JOSEPH.....	443, 446
Raspel, JOSEPH (LEWIS).....	443
Raspel, MALTZ.....	443
Raspel, MALTZ (COTTLE).....	444
Raspel, MILLER.....	444
Raspel, PEET.....	446
Raspel, WIENER.....	443
Rauchabsaugrohr, KLEINSASSER.....	36
RAY, Hypophysenkürette.....	334
RECAMIER, Uteruskürette.....	597, 598
Recordspritze.....	596
REDA, Amputationsmesser.....	44
REDA, Augenmagnet.....	395
REDA, Cilienpinzette.....	395
REDA, EXCENTER, Verbandschere.....	69/2
REDA, Fadengabel.....	221
REDA, Fingerringssäge.....	297
REDA, Führungshohlsonde.....	221/1
REDA, Gipsspreizer.....	232
REDA, Handbohrapparat.....	300
REDA, Hauthäkchen.....	150
REDA, Kappenzange.....	615
REDA, Klingenbrecher.....	45
REDA, Knochenhaltezange.....	246, 247

REDA, Mikro-Rohrschaftzange	474	ROCHARD, Bauchdeckenhalter	186	Sauggriff, WULLSTEIN	338
REDA, Nasenspekulum	423	ROCHARD, Fixiervorrichtung	186	Saugkanüle, ROSEN	338
REDA, Organ- u. Gewebefalzange	111	ROCHESTER-CARMALT, Arterienklemme	109	Saugkanüle, SCHMID	338
REDA, Parametriumklemme	128/1	ROCHESTER-OCHSNER, Arterienklemme	108	Saugkürette, NOVAK	587
REDA, Parametriumschere	63	ROCHESTER-PEAN, Arterienklemme	108	Saugkürette, RANDALL	587
REDA, scharfer Löffel	256	ROEDER, Tuchklemme	132	Saugraspatorium, GUILLEN	433/1
REDA, Sichelmesser	435	ROGER, Septumelevator	437	Saugrohr	337/1
REDA, Watteträger	203	ROGERS, Hysterektomieklammer	127	Saugrohr, ADSON	337
REDON, Führungsnadel	207	ROGGE, Sterilisierzange	227	Saugrohr, ANDREW-PYNCHON	28
REES, Face-Lift-Schere	73	Rohrschaftszange, REDA	474	Saugrohr, BABY-YANKAUER	27
Reibahle	304	Rollenklemme	131	Saugrohr, BARON	336
REILL, Knochenhaltezange	248	Rollenklemme, BÜLOW-GUNAR-HEY	130	Saugrohr, COOLEY	328
REINER, Gipsmesser	233	ROLLET, Extirpationsmeißel	374	Saugrohr, DeBAKEY	28
REINER, Ohrspritze	406	ROLLET, Tränensackhäkchen	375	Saugrohr, FERGIUSSON	337
Reinigungsaufsatz	626	Rongeur, CLOWARD	342	Saugrohr, FRAZIER/FERGIUSSON	337
Reinigungspistole	626	Rongeur, CUSHING	340	Saugrohr, HOUSE	337/2
Rektal-Absaugrohr, BUJE	566	Rongeur, DECKER	341	Saugrohr, PLESTER	338
Rektal-Spekulum, SAWYER	560	Rongeur, FERRIS-SMITH	343	Saugrohr, POOLE	27
Rektal-Spekulum, HILL-FERGUSON	560	Rongeur, LOVE-GRUENWALD	340	Saugrohr, ROSEN	338
Rektum-Anastosenklemme, HAYES	545	Rongeur, OLDBERG	341/1	Saugrohr, SCHMID	338
Repositionszange, ROWE	459	Rongeur, PEAPOD	341/1	Saugrohr, YANKAUER	27
RESANO Pinzetten	85	Rongeur, SCHLESINGER	342	Saugrohr, YASARGIL	337/1
RESANO, Darmklemme	542	Rongeur, SPURLING	340	Saugrohr, ZÖLLNER	337/1
RESANO, Kapselschere	53/2	Rongeur, WAGNER	343	Saugschlauch	231
Resektionsmesser	47	ROSE, Wundhaken	140	SAWTELL, Tonsillenzange	467
Retraktor, PERCY	296	ROSEN, Messer	418	SAWYER, Rektal-Spekulum	560
Retraktoren, Intraoral	463/1	ROSEN, Nadel	419	SAYRE, Elevator	281
Retraktor-System, LEYLA	368 - 368/4	ROSEN, Saugkanüle	338	SCAGLIETTI, Hohlmeißelzange	240
REVERDIN, Darmspatel	143/3	ROSER-KOENIG, Mundsperrer	454	SCALP-CONTOUR, Wundspreizer	169
REVERDIN, Nadel	220	ROSS, Aortahaken	148/1	Schädelhalter, CRUTCHFIELD	327
REYNOLDS, chirurgische Schere	54/1	ROUX MINI, Wundhaken	140	Schädelspalter	267
REYNOLDS, Supercuttschere	72	ROUX, Wundhaken	139	Schädelstanze, CONE	331
Rhinoplastische Schere, FOMON	65/1	ROUX-BABY, Wundhaken	140	Schädelzange, DeVILBISS	332
RIBBON, Bauch- u. Darmspatel	143/1	ROWE, Repositionszange	459	SCHAEDEL, Tuchklemme	132
RICARD, Bauchdeckenhalter	191	RUBIN, Septummeißel	440	Schaft	230/4, 230/7
RICHARDSON, Wundhaken	142	RUBIN, Septumzange	428	Schale, PETRI	620
RICHARDSON-EASTMAN, Wundhaken	142	RUDD, Hämorrhoidal-Ligatur	568	Schälmesser, Tracheotomie	475
RICHARDSON-GRIP, Wundhaken	142	RUMEL, Arterienklemme	117	SCHAMBERG, Komedonenquetscher	608
RICHTER-HEATH, Wundklammerzange	224	RUMEL-BELMONT, Tourniquet	528	Scharfer Löffel	255
RIGBY, Bauchdeckenhalter	189/2	RUMEL-DeBAKEY, Gefäßklemme	499	Scharfer Löffel, BRUNS	251, 254
RI-MINI, Diagnostik-Besteck	17	RUSKIN, Hohlmeißelzange	239	Scharfer Löffel, BUSHE	256
RING, Zungenspatel	455	RUSKIN-LISTON, Knochensplitterzange	241	Scharfer Löffel, COBB	252
Ringmesser, BARNHILL	450	RUSSEL-DAVIS, Zungenspatel	458	Scharfer Löffel, DAUBENSPECK	255
Ringmesser, BECKMANN	450	RUSSISCHES MODELL, Fasspinzette	85	Scharfer Löffel, HALLE	253
Ringmesser, LAFORCE	450	RYDEL-SEIFFERT, Stimmgabel	404	Scharfer Löffel, JACOBSON	257
Ringmesser, St. CLAIR-THOMSON	450	RYDER, Nadelhalter	210	Scharfer Löffel, JANSEN	257
Rippenkontraktor, BAILEY	489/1			Scharfer Löffel, LEMPERT	256
Rippenkontraktor, BAILEY-BABY	489/1			Scharfer Löffel, MARTINI	257
Rippenkontraktor, BAILEY-GIBBON	489/1			Scharfer Löffel, REDA	256
Rippenkontraktor, SELLORS	489/1			Scharfer Löffel, SCHEDE	251
Rippenschere	480			Scharfer Löffel, SCOVILLE	253
Rippenschere, BETHUNE	481			Scharfer Löffel, SPINAL	253
Rippenschere, BRUNNER	481			Scharfer Löffel, SPRATT	251
Rippenschere, COLLIN	480			Scharfer Löffel, VOLKMANN	257
Rippenschere, CORYLLOS	480			Scharfer Löffel, WILLIGER	255, 257
Rippenschere, GIERTZ-STILLE	481			SCHEDE, scharfer Löffel	251
Rippenschere, GLUCK	480			Scheidenspekula	569 - 577
Rippenschere, SAUERBRUCH	481			Scheidenspekula, AUVARD	576
Rippenschere, STILLE	480			Scheidenspekula, BREISKY	577
Rippensperrer	487/2			Scheidenspekula, COLLIN	570
Rippensperrer, DE BAKEY	485/1			Scheidenspekula, CUSCO	570, 571
Rippensperrer, CHERRY	488			Scheidenspekula, DELEE	574
Rippensperrer, COOLEY	485, 487			Scheidenspekula, DOYEN	574
Rippensperrer, COOLEY-NEONATAL	485			Scheidenspekula, GRAVE	570
Rippensperrer, FINOCHIETTO	482, 484			Scheidenspekula, JACKSON	573
Rippensperrer, FINOCHIETTO-BABY	482			Scheidenspekula, KALLMORGEN	573
Rippensperrer, FINOCHIETTO-BURFORD	483			Scheidenspekula, KRISTELLER	572
Rippensperrer, HAIGHT	487			Scheidenspekula, LANDAU	577
Rippensperrer, MORSE	484			Scheidenspekula, O'SULLIVAN-O'CONNOR	576
Rippensperrer, MORSE-FAVALORO	484			Scheidenspekula, PEDERSON	570
Rippensperrer, TUFFIER	487			Scheidenspekula, SCHERBAK	575
RITTER-HALLE, Stirnhöhldilatator	433			Scheidenspekula, SEMM	571
ROBB, Spatel	530/1			Scheidenspekula, SIMS	573
ROBERTS, Arterienklemme	117			Scheidenspekula, VU-MORE	569

S

SCHIELE, Goniotomiemesser	373	Schere, POTTS-SMITH	60, 61	SCHULZE-BERGMANN, Mastdarm-Spekula	560
SCHNEIMANN, Aufsatz	472	Schere, PRINCE	59	SCHUMACHER, Aufsatz	472
SCHERBAK, Scheidenspekula	575	Schere, QUINBY	67	SCHUMACHER, Biopsiezange	588
Schere, BABY-METZENBAUM	71	Schere, REDA	77, 80	SCHUMACHER, Nabelschnurschere	64
Schere, BARRAQUER	75	Schere, REDA EXCENTER	69/2	SCHUMACHER, Sternumschere	481
Schere, BEEBEE	68	Schere, REES	73	SCHUMACHER, Uterus-Biopsiezange	589
Schere, BERGMANN	69/1	Schere, RESANO	53/2	Schlüssel	619
Schere, BETHUNE	481	Schere, REYNOLDS	54/1, 72	Schwammzange	136
Schere, BOETTCHER	59	Schere, SANVENERO	54/1	Schwammzange, FOERSTER	136
Schere, BRAUN-STADLER	64	Schere, SATINSKY	65/2	Schwammzange, RAMPLEY	136
Schere, BRUNNER	481	Schere, SAUERBRUCH	481	SCHWEIGGER, Kapselpinzette	391
Schere, BRUNS	70	Schere, SAUERBRUCH-FREY	481	Schwingmesser, BALLENGER	436
Schere, BUSCH	64	Schere, SCHMIEDEN-TAYLOR	65/1	SCOVILLE, Haken	196
Schere, CASTROVIEJO	79	Schere, SCHUMACHER	64, 481	SCOVILLE, Laminektomiespreizer	196
Schere, COLLIN	480	Schere, SEUTIN	69/2	SCOVILLE, Nerwurzelhaken	329/1, 330
Schere, CORYLLOS	480	Schere, SIEBOLD	62	SCOVILLE, scharfer Löffel	253
Schere, COTTLE	56, 59	Schere, SIMS	62	SCOVILLE-HAVERFIELD, Laminektomiespreizer	196
Schere, CRAFOORD	65/2	Schere, SMITH-US-ARMY	69/1	SCUDDER, Darmklemme	541
Schere, DEAN	59	Schere, Standard	51	SEBILÉAU, Raspator	275
Schere, DeBAKEY	60, 61	Schere, STEVENS	58, 72	SEDILLOT, Raspator	274, 275
Schere, DIETRICH	60	Schere, STILLE	480	Segmentsägeblatt	230/5, 230/15
Schere, DOYEN	63	Schere, STRULLY	65	SEGOND, Hysterektomieklammer	125
Schere, DUBOIS	63	Schere, SYSTRUNK	66	SEGOND-LANDAU, Hysterektomieklammer	125
Schere, ESMARCH	69/2	Schere, THOREK	65/2	Sehenfasszange	293
Schere, FAVALORO	61	Schere, TOENNIS-ADSON	65	Sehnenfassinstrument, BRAND	293
Schere, FERGUSSON	66	Schere, UNIVERSAL	67, 70	Sehnenfassinstrument, CAROLL	293
Schere, FOMON	58, 65/1	Schere, USA Mod.	64	Sehnenfassinstrument, KLEINERT-KUTZ	294
Schere, FREEMAN	74	Schere, VANNAS	79	Sehnenfasspinzette, LARSEN	292
Schere, GLUCK	480	Schere, WAGNER	67, 72	Sehnenfasszange, JACKSON	292
Schere, GOLDMAN-FOX	67	Schere, WALDMANN	64	Sehnenführer, BUNELL	294
Schere, GOMEL	80	Schere, WECKER	75	Sehnenhaltezege, STEINMANN	292
Schere, GOOD	59	Schere, WELLER	53/2	Sehnschäler, BRAND	294
Schere, GORNEY	73	Schere, WERTHEIM	63	Sehnschäler, BUNNELL	292
Schere, GRADLE	57	Schere, WESTCOTT	75	SEIFERT, Aufsatz	472
Schere, GRAEFÉ	56	Schieblehre, TOWNLEY	26	Sektionsnadel	268
Schere, Haut	610	Schielhaken, GRAEFÉ	375	SELDIN, Raspator	277
Schere, HEATH	66	Schielhaken, JAMESON	375	SELECT, Verbindungskabel	633
Schere, HEPP-SCHUIDEL	78	Schildrüsenhaken, SCHOENBORN	479	SELLHEIM, Geburtslöffel	607
Schere, HEYMANN	58	SCHIMMELBUSCH, Verbandstoffrommel	622	SELLORS, Rippenkontraktor	489/1
Schere, IRIS	54/2, 72	SCHINK, Dermatome	49	SEMB, Bronchusklemme	491
Schere, JORGENSEN	53	SCHIOETZ, Tonometer	394/2	SEMB, Hohlmeisselzange	240
Schere, JOSEPH	54/1	Schlanke scheren bipolare	634	SEMB, Knochenhaltezege	243
Schere, KAYE	73	Schlauchhalterung	188	SEMB, Knochen splitterzange	242
Schere, KELLY	61	Schlauchklemme	129	SEMB, Raspator	278
Schere, KILLIAN	471	Schlauchklemme, BÜLOW-GUNAR-HEY	130	SEMKEN, anatomische Pinzette	86
Schere, KILNER	54/1	Schlauchklemme, KLINIKUM BERLIN	129	SEMKEN, chirurgische Pinzette	86
Schere, KILNER/RAGNELL	72	Schlauchklemme, PRESBYTERIAN	129	SEMM, Scheidenspekula	571
Schere, KLINCKENBERGH-LOTH	65/2	Schlauchverbindungsstück	609	SENN-GREEN, Wundhaken	153
Schere, KNAPP	55	SCHLESINGER, Laminektomiezege	342	SENN-MILLER, Wundhaken	143
Schere, KNOWLES	70	Schliessklemme, STONE	545	Septemzange, HEYMANN	425
Schere, LA GRANGE	69, 72	Schlinge, Polypenschnürer	433/2	Septemzange, KNIGHT	425
Schere, LANDOLT	58	Schlüssel, Meissel	266	Septumelevator, BALLENGER	439
Schere, LEXER	53	Schlüssel, Osteotome	266	Septumelevator, COTTLE	439
Schere, LEXER-BABY	53	Schlüsselpaar, Gipsäge u. Autopsiesäge	230/18	Septumelevator, COTTLE-JOSEPH	439
Schere, Ligatur, TC	54	SCHMEIDEN, Nasenzange	427	Septumelevator, FREER	437, 439
Schere, LISTER	69/1, 72	SCHMID, Gefäß- u. Spülkanüle	338	Septumelevator, HAJEK-BALLENGER	439
Schere, LITTAUER	66	SCHMIEDEN, Führungshohlsonde	221	Septumelevator, HALLE	437
Schere, LITTLER	55	SCHMIEDEN-DICK, Unterbindungsnadel	219	Septumelevator, HOWARTH	438
Schere, LOCKLIN	69	SCHMIEDEN-TAYLOR, Duraschere	65/1	Septumelevator, JOSEPH	437
Schere, LORENZ	70	Schnellkupplungs-Handgriff	301	Septumelevator, KILLIAN	438, 439
Schere, MARTIN	65/1	Schnellkupplungs-T-Handgriff	300, 301	Septumelevator, McKENTY	437, 438
Schere, MAYO	52/1, 71	SCHNIDT, Tonsillenzange	467	Septumelevator, PENNINGTON	438
Schere, MAYO-NOBLE	52/1	SCHOENBORN, Schildrüsenhaken	479	Septumelevator, PIERCE	438
Schere, MAYO-STILLE	52/1, 71	Schraubenhaltezege, LANE	325	Septumelevator, ROGER	437
Schere, McINDOE	65/1	Schraubenzieher, Ferrozellgriff	323	Septumelevator, SINUS	438
Schere, METZENBAUM	53/1, 54, 71	Schraubenzieher, LANE	323, 324	Septumhohlmeissel, FREER	442/1
Schere, MIKRO	76	Schraubenzieher, WILLIAMS	323	Septumhohlmeissel, HAJEK	442/1
Schere, Nagel	609, 610	SCHRÖDER, Hakenzange	584	Septumhohlmeissel, KILLIAN-CLAUS	442/1
Schere, Neurochirurgie	65	SCHRÖDER, Uteruslöffel	595	Septummeissel, CINELLI	441
Schere, NORTHBENT	66	SCHROEDER (POZZI), Hakenzange	582	Septummeissel, COTTLE	440
Schere, NOYES	75	SCHROEDER, Hakenzange	583	Septummeissel, FOMON	441
Schere, Parametrium	63	SCHUBERT, Biopsiezange	588	Septummeissel, FREER	439
Schere, PECK-JOSEPH	74	SCHUKNECHT, Messer	418	Septummeissel, NEIVERT-ANDERSON	442
Schere, POTTS-DeMARTEL	59	SCHULTZE, Salpingograph	596	Septummeissel, RUBIN	440

Septummeißel, SHEEHAN.....	441	SMITH, Spreizer.....	463/5	Spitze, YANKAUER Saugrohr.....	27
Septummeißel, SILVER.....	442	SMITH, Spreizzange.....	463	Splitterpinzette.....	91
Septumosteotom, CINELLI.....	441	SMITH-BUIE, Analspreizer.....	561	Splitterpinzette, CARMALT.....	91
Septumosteotom, FOMON.....	441	SMITH-PETERSEN, Hohlmeißel.....	261	Splitterpinzette, FEILCHENFELD.....	91
Septumosteotom, SHEEHAN.....	441	SMITH-PETERSEN, Hohlmeißelzange.....	238	Splitterpinzette, HUNTER.....	91
Septumrichtzange, ASCH.....	449	SMITH-PETERSEN, Osteotom.....	261	Splitterzange, ARCHER.....	92
Septumrichtzange, WALSHAM.....	449	SMITHWICK, Anlegezange.....	326	Splitterzange, PEET.....	92
Septumschere, KILLIAN.....	471	SMITHWICK, Nervhaken.....	329	Splitterzange, STIEGLITZ.....	92
Septumzange, BRUENINGS.....	425	SNELLEN, Muskelpinzette.....	393	Splitterzange, VIRTUS (RALK).....	92
Septumzange, CRAIG.....	426	SNELLEN, Starschlinge.....	378	SPRATT, scharfer Löffel.....	251
Septumzange, LUC.....	426	SOMER, Uterus-Fasszange.....	585	Spreizer, ALAN-PARKS.....	561
Septumzange, MIDDLETON-JANSEN.....	430	Sonde.....	199, 335	Spreizer, BENSON.....	544
Septumzange, RUBIN.....	428	Sonde, BRODIE.....	199	Spreizer, Lateral.....	569
Sequesterzange.....	249	Sonde, COLLIN.....	586	Spreizer, LEGUEU.....	553
SERPENTINE-GRASPER, Fasszange.....	593	Sonde, DOYEN.....	199	Spreizer, MILLIN.....	552
Set Doppel-Sägeblatt.....	230/7	Sonde, FISH.....	199	Spreizer, SMITH.....	463/5
Set Filtertüten.....	231/1	Sonde, HARMS.....	381	Spreizer, SMITH-BUIE.....	561
Set Sägeblatt.....	230/5, 230/6	Sonde, JACOBSON.....	335	Spreizer, THOMSON-WALKER.....	552
SEUTIN, Verbandschere.....	69/2	Sonde, LOCKHARDT-MUMMERY.....	200	Spreizzange, SMITH.....	463
SEXTON, Ohrmesser.....	408	Sonde, MARTIN.....	586	Spritze gefüllt mit Fett.....	230/18
Seziermesser, VIRCHOW.....	48	Sonde, NELATON.....	199	Spülkanüle, BISHOP-HARMON.....	394/1
SHAMBAUGH, Hähchen.....	419	Sonde, PRATT.....	563	Spülkanüle, EICKEN (KILLIAN).....	433
SHAPLEIGH, Ohrschlinge.....	410	Sonde, SIMS.....	586	Spülkanüle, KILLIAN.....	433, 433/1
SHEA, Mikro-Ohrschere.....	413	Sonde, VALLEIX.....	586	Spülkanüle, SIMCOE.....	394/2
SHEEHAN, Osteotom.....	441	Sonde, WATSON-CHEYNE.....	199	SPURLING, Laminektomiezeange.....	340
SHEEHAN, Septummeißel.....	441	Sonde, WORST.....	381	St. CLAIR-THOMSON, Ringmesser.....	450
SHEETS, Augenkanüle.....	394/2	Sondenspitzen, NABATOFF.....	201	St. MARKS, Wundhaken.....	165
Sichelmesser, REDA.....	435	Spannam, flexibel, LEYLA.....	368/3	St. MARKS, PELVIS-Haken.....	165
Sichelmesser, Tracheotomie.....	475	Spannplatte.....	49	St. MARTIN, Nahtpinzette.....	392
SIEBOLD, gynäkologische Schere.....	62	Spannschlüssel.....	313	STAMM, Knochensplitterzange.....	241
SIEGLE, Ohrspekula.....	402	Spatel.....	203, 530/1, 612/1	STANDARD (NELSON) Trokar.....	204
Silberklammern.....	326	Spatel, KOCHER.....	552	Standard scheren bipolare.....	634
Silikon einlage, DAVIS-BOYLE.....	455	Spatel, LEGUEU.....	552	Standard, chirurgische Schere.....	51
Silikonschlauch, McIVOR.....	457	Spatel, ROBB.....	530/1	Standgefäß.....	620
SILVER, Dermatome.....	50	SPATULA AND PACKER.....	612	Stanze, Aorta.....	528
SILVER, Septummeißel.....	442	Spekula JOLL (FRIEDMANN).....	577	Stanze, CITELLI.....	430
SIMCOE, Spülkanüle.....	394/2	Spekula, BARR.....	559	Stanze, COLCLOUGH.....	344/1
SIMON, Uteruslöffel.....	594	Spekula, BODENHAMMER.....	559	Stanze, FERRIS-SMITH-KERRISON.....	344, 344/2
SIMON, Wundhaken.....	164	Spekula, BREISKY.....	577	Stanze, HAJEK-KOFLER.....	429, 431
SIMPSON, Geburtszange.....	602	Spekula, COLLIN.....	570	Stanze, KERRISON.....	428
SIMPSON-BRAUN, Geburtszange.....	602	Spekula, CUSCO.....	570, 571	Stanze, OSTROEM.....	430
SIMPSON-LUIKART, Geburtszange.....	603	Spekula, CZERNY.....	559	Stanze, Zirkular.....	432
SIMS, gynäkologische Schere.....	62	Spekula, DELEE.....	574	Starlöffel, DAVIEL.....	377
SIMS, Mastdarm-Spekula.....	559	Spekula, DOYEN.....	574	Starlöffel, GRAEFE.....	377
SIMS, Scheidenspekula.....	573	Spekula, FRIEDMANN.....	577	Starlöffel, KNAPP.....	378
SIMS, Sonde.....	586	Spekula, GRAVE.....	570	Starmesser, DEUTSCHMANN.....	371
SIMS, Uterusdepressor.....	586	Spekula, HILL-FERGUSON.....	560	Starmesser, GRAEFE.....	371
SIMS, Uteruskürette.....	597, 598	Spekula, JACKSON.....	573	starrer Haltearm, LEYLA.....	368/1
SIMS, Uterussonde.....	586	Spekula, KALLMORGEN.....	573	Starschlinge, SNELLEN.....	378
SIMS-MAIER, Kornzange.....	134	Spekula, KOGAN.....	577	Starschlinge, WEBER.....	378
SINGLEY, Gewebefasspinzette.....	88	Spekula, KRISTELLER.....	572	Starschlinge, WILDER.....	378
SINUSKOPIE-TROKAR.....	205	Spekula, LANDAU.....	577	Stativ.....	188
SINSKEY, Hähchen.....	376	Spekula, MATHIEU.....	560	Staubbeutel.....	231/1
SINUS, Septumelektor.....	438	Spekula, O'SULLIVAN-O'CONNOR.....	576	Staubbinde, ESMARCH.....	296
Sinuskopie-Zange.....	431	Spekula, PEDERSON.....	570	Staubsauger.....	231
Skalpelle Mini.....	41	Spekula, PRATT.....	559	STAUDE-MOORE, Hakenzange.....	582
Skalpelle, steril.....	43	Spekula, SAWYER.....	560	Stechbecken.....	621/1
Skalpellgriff.....	38 - 42	Spekula, SCHERBAK.....	575	STEINMANN, Knochen nagel.....	307, 308
Skalpellgriff Mini.....	41	Spekula, SCHULZE-BERGMANN.....	560	STEINMANN, Sehenhaltezeange.....	292
Skalpell-Griffe.....	38-41	Spekula, SEMM.....	571	STELLBRINK, Hohlmeißelzange.....	234
Skalpell-Griffe BARRON.....	38	Spekula, SIMS.....	559, 573	sterile Ersatzlinge.....	50
Skalpellklingen.....	42	Spekula, TRÉLAT.....	571	sterile Skalpell-Klingen.....	42
Skalpellklingen-Entferner.....	42	Spekula, VU-MORE.....	569, 570	Sterilisierklammer, BUNT.....	227
SKENE, Hakenzange.....	582	SPENCER, Fadenschere.....	66	Sterilisierklammer, MAYO.....	227
Sklerotom, GUYTON-LUNDSGAARD.....	373	SPENCER-WELLS, Arterienklemme.....	109	Sterilisiersierschale.....	622
Sklerotom, LUNDSGAARD.....	373	Sperrer, ALAN-PARKES.....	561	Sterilisierzange.....	227
SLS, Clipanlagezange.....	524, 525	Sperrer, DAVIS-BOYLE.....	455	Sterilisierzange, CHEATLE.....	227
SLUDER-BALLENGER, Tonsillotom.....	470	Sperrer, DINGMANN.....	456	Sterilisierzange, ROGGE.....	227
SMELLIE, Haken.....	605	Sperrer, KILNER-DOUGHTY.....	456	Sterilisierzange, UNIVERSAL.....	227
SMELLIE, Perforatorie.....	607	Sperrer, Mammaria.....	487/1	STERNBERG, Wangenhalter.....	453
SMILLIE, Knochenheber.....	291	SPINAL, scharfer Löffel.....	253	Sternummeißel, LEBSCHE.....	267, 480
SMILLIE, Meniskusmesser.....	292	SPINALhaken, TAYLOR.....	291	Sternumschere, SCHUMACHER.....	481
SMITH US ARMY, Verbandschere.....	69/1	SPINA-NASALIS, Wundhaken.....	461	Sternusperr, Mammaria.....	487/1
SMITH, Sagittalspreizer.....	463/5	Spiralbohrer.....	302	Stethoskop, ANESTOPHON.....	23

Stethoskop, DUPLEX.....	23
Stethoskop, PINARD.....	23
STEVENS, Irispinzette.....	383
STEVENS, Linsenhaken.....	375
STEVENS, Nadelhalter.....	214
STEVENS, Sehenschere.....	58
STEVENS, Supercutschere.....	72
STEVENSON, Lidsperrerr.....	371
STIEGLITZ, Splitterzange.....	92
STILLE, Arterienklemme.....	122
STILLE, Flachmeissel.....	260
STILLE, Gipschere.....	229
STILLE, Hohlmeissel.....	260
STILLE, Osteotom.....	260
STILLE, Pinzette.....	81, 81/1
STILLE, Rippenschere.....	480
STILLE-BARRAYA, Gefäßspinzette.....	88
STILLE-HORSLEY, Knochensplitterzange.....	242
STILLE-LISTON, Knochensplitterzange.....	242
STILLE-LUER, Hohlmeisselzange.....	239
STILLE-RUSKIN, Hohlmeisselzange.....	239
Stimmgabel.....	403, 404
Stimmgabel, HARTMANN.....	403
Stimmgabel, LUCAE.....	404
Stimmgabel, RYDEL-SEIFFERT.....	404
Stimnhöhliendilatator, RITTER-HALLE.....	433
Stimlampe, CLAR.....	22
Stirnspiegel, ZIEGLER.....	21
STOCKMANN, Penisklemme.....	553/1
STONE, Schließklemme.....	545
STONE-WATT, Darmklemme.....	545
STONE-WATT, Klemmschloss.....	545
Stössel.....	258, 259
Stössel, CASPAR.....	258
STRABISMUS, Schere.....	58
Strabismuspinzette, BONACCOLTO.....	385
Strabismuspinzette, DASTOOR.....	386
Strabismuspinzette, JAMESON.....	385
Strabismuspinzette, McCULLOUGH.....	385
STRANDELL-STILLE, Wundhaken.....	157
STRASSBURGER, Pinzette.....	89
STRATTE, Nadelhalter.....	212
STRAUSS, Penisklemme.....	553/1
Stringer.....	228
STRUEMPEL, Fremdkörperzangchen.....	412
STRULLY, neuro-chirurgische Schere.....	65
STRUYCKEN, Nasenzange.....	427
Supercutschere.....	71
Supercutschere, BABY-METZENBAUM.....	71
Supercutschere, FREEMAN.....	74
Supercutschere, GORNEY.....	73
Supercutschere, IRIS.....	72
Supercutschere, KAYE.....	73
Supercutschere, KILNER.....	72
Supercutschere, LISTER.....	72
Supercutschere, MAYO.....	71
Supercutschere, MAYO-STILLE.....	71
Supercutschere, METZENBAUM.....	71
Supercutschere, REES.....	73
Supercutschere, REYNOLDS.....	72
Supercutschere, STEVENS.....	72
Supercutschere, WAGNER.....	72
SYSTRUNK, chirurgische Schere.....	66

T

TABB, Messer.....	418
Tablett.....	620
TAKAHASHI, Nasenzange.....	427
Tamponstopfer, LUNIATSCHEK.....	465
Tamponzange, BOZEMANN.....	138
Tamponzange, BOZEMANN-DOUGLAS.....	138
Tangentialklemme, DeBAKEY.....	502
Tangentialklemme, DeBAKEY-SATINSKY.....	502

Tangentialklemme, SATINSKY.....	502
TARNIER, Geburtszange.....	604
TAYLOR, chirurgische Pinzette.....	87
TAYLOR, Haken.....	196
TAYLOR, Perkussionshammer.....	24
TAYLOR, Spinalhaken.....	291
TC chirurgische Schere fein, REYNOLDS.....	54
TC chirurgische Schere, STANDARD.....	51
TC Nasenraspel, FOMON.....	445
TC Pinzette, anatomisch.....	81
TC Pinzette, chirurgisch.....	81/1
TC Pinzette, CUSHING.....	83
TC Pinzette, GILLIES.....	86
TC Pinzette, SEMKEN.....	86
TC Pinzette, WAGENSTEEN.....	89
TC Schere, FREEMAN.....	74
TC Schere, GORNEY.....	73
TC Schere, KAYE.....	73
TC Schere, PECK-JOSEPH.....	74
TC Schere, REES.....	73
TEALE, Hakenzange.....	583
TEBBETTS, Wundhaken.....	197
Teleskop-Bohrdrahtstütze.....	299
TERRIER Arterienklemmen.....	106
TERSON, Kapselpinzette.....	391
TESSIER, Haken.....	463/3
TESSIER, Mobilisierhaken.....	463/3
T-Handgriff, HUDSON.....	300
T-Handgriff, Schnellkupplung.....	300, 301
THIERRY, Geburtszange.....	603
THOMAS, Uteruskürette.....	599
THOMAS-GAYLOR, Biopsiezange.....	588
THOMAS-ALLIS, Darmfazzzange.....	538
THOMSON-WALKER, Blasenwundspreizer.....	552
THOREK, Gallenblasenschere.....	65/2
THUDICHUM, Nasenspekula.....	421
TIECK-HALLE, Nasenspekula.....	423
Tiefen-Messinstrument.....	594
Tiefensägeblatt.....	230/6, 230/16
TILLEY, Ohrzangchen.....	411
TISCHLER-DOWN, Uterus-Biopsiezange.....	591
TISCHLER-KEVORKIAN, Uterus-Biopsiezange.....	592
TISCHLER-MORGAN, Uterus-Biopsiezange.....	590, 591
TISCHLER-UP, Uterus-Biopsiezange.....	591
Titan-Arterienklemme, CRILE.....	107
Titan-Arterienklemme, KELLY.....	106
Titan-Bulldogklemme.....	102
Titan-Pinzette, DeBAKEY.....	99
TOBOLD, Wateträger.....	203
TOBOLD, Zungendrucker.....	453
TOENNIS, Arterienklemme.....	117
TOENNIS, Dura-Dissektor.....	332
TOENNIS-ADSON, Schere.....	65
TOHUKU, Tuchklemme.....	132
Tonometer, SCHIOETZ.....	394/2
Tonsillendissektor, HURD.....	465
Tonsillendissektor, LOPEZ-REINKE.....	465
Tonsillendraht.....	468
Tonsillenelevator, CARPENTER.....	465
Tonsillenelevator, HENKE.....	465
Tonsillen-Elevatoren, GWYNNE EVANS.....	465
Tonsillenfazzzpinzette, MARSCHIK.....	468
Tonsillenfazzzange, ABRAHAM.....	468
Tonsillenfazzzange, BALLENGER.....	467
Tonsillenfazzzange, BLOHMKE.....	467
Tonsillenfazzzange, COLVER.....	467
Tonsillenfazzzange, MARSCHIK.....	468
Tonsillenfazzzange, NEGUS.....	467
Tonsillenfazzzange, SAWELL.....	467
Tonsillenfazzzange, SCHNIDT.....	467
Tonsillenfazzzange, TYDING.....	468
Tonsillenfazzzange, WHITE.....	467
Tonsillennmesser, ABRAHAM.....	466
Tonsillennmesser, BRUENINGS.....	466

Tonsillennmesser, CANFIELD.....	466
Tonsillennmesser, CARPENTER.....	465
Tonsillennmesser, FISHER.....	466
Tonsillennadel.....	470
Tonsillennadel, CLAUS.....	466
Tonsillennadel, CLAUS-EICKEN.....	466
Tonsillennadel, DUPUY-WEISS.....	466
Tonsillennadel, NAGER.....	466
Tonsillenschere.....	59
Tonsillenschere, BOETTCHER.....	59
Tonsillenschere, DEAN.....	59
Tonsillenschere, GOOD.....	59
Tonsillenschere, PRINCE.....	59
Tonsillenschneider, BRUENINGS.....	468
Tonsillenschneider, EVES.....	468
Tonsillenschneider, TYDING.....	469
Tonsillenspritze.....	470
Tonsillenzange, BALLENGER.....	467
Tonsillenzange, BLOHMKE.....	467
Tonsillenzange, NEGUS.....	467
Tonsillenzange, SAWTELL.....	467
Tonsillenzange, SCHNIDT.....	467
Tonsillenzange, TYDING.....	468
Tonsillenzange, WHITE.....	467
Tonsillotom, SLUDER-BALLENGER.....	470
Tonsillotom, TYDING.....	469
TOOK, Hornhautmesser.....	373
Tourniquet, RUMEL-BELMONT.....	528
TOWNLEY, Schieblehre.....	26
TOWNSEND, Uterus-Biopsiezange.....	591
TOYNBEE, Ohrspekula.....	399
Trachealdilatator, LABORDE.....	476
Trachealdilatator, TROUSSEAU.....	476
Trachealdilatator, TROUSSEAU-BABY.....	476
Trachealhaken, BOSE.....	477
Trachealhaken, ITERSON.....	477
Trachealhaken, JACKSON.....	476
Trachealhaken, NEWS.....	477
Trachealkanüle, CHEVALIER-JACKSON.....	479
Trachealkanüle, LUER.....	479
Trachealkanüle, WAGENER-MOSHER.....	477
Trachealwundspreizer, BOSE.....	476
Trachompinzette, KNAPP-LUER.....	393
Tränenkanaldilatator, CASTROVIEJO.....	381
Tränenkanaldilatator, WILDER.....	381
Tränenkanalsonde, BOWMAN.....	381
Tränensackdissektor, LANG.....	378
Tränensackhähkchen, KNAPP.....	375
Tränensackhähkchen, ROLLET.....	375
TRAVERS, Wundspreizer.....	172
Trephine, KEYES.....	608
TROELTSCH, Nasenpinzette.....	424
TROELTSCH, Ohrpinzette.....	410, 424
TROEMNER, Perkussionshammer.....	24
Trokar, COAKLEY.....	204
Trokar, DOUGLAS.....	204
Trokar, LICHTWITZ.....	204
Trokar, NELSON.....	205
Trokar, OCHSNER.....	205
Trokar, SINOSKOPIE.....	205
Trokar, STANDARD (NELSON).....	204
Trokar, UNIVERSAL.....	204
TROUSSEAU, Trachealdilatator.....	476
TROUSSEAU-BABY, Trachealdilatator.....	476
TROUTMAN, Irispinzette.....	384
TROUTMAN, Muskelpinzette.....	389
TROUTMAN-CHRIS, Klingenbrecher.....	45
Tubenkatheter, SCHULTZE.....	596
Tubulus, gerade, einfach.....	267
Tuchklemme.....	133
Tuchklemme, BACKHAUS.....	132
Tuchklemme, BACKHAUS-CLIP.....	132
Tuchklemme, BALL AND SOCKET.....	133
Tuchklemme, BERNHARD.....	133

Tuchklemme, DOYEN	133
Tuchklemme, JONES	132
Tuchklemme, JONES-CLIP	132
Tuchklemme, LANE	133
Tuchklemme, LORNA	133
Tuchklemme, PEERS	132
Tuchklemme, ROEDER	132
Tuchklemme, SCHAEDEL	132
Tuchklemme, TOHOKU	132
Tuchklemmen, OMBREDANNE (JACKSON)	133
TUFFIER, Gewebefasszange	110
TUFFIER, Rippensperrerr	487
TUFFIER, Wundhaken	147
Tumorfasszange, LANDOLT	341
Tumorpinzette, YASARGIL	97
Tupferzange, BRYANT	137
Tupferzange, CHERON	137
Tupferzange, COLLIN	137
Tupferzange, FOERSTER	136
Tupferzange, LISTER (SINUS)	137
Tupferzange, PELKMANN	137
Tupferzange, RAMPLEY	136
TURNBULL, Nagelzange	609
TYDING, Tonsillenschürter	469
TYDING, Tonsillenzange	468
TYDING, Tonsillotom	469

U

UCKERMANN, Watteträger	203
Uhmacher Pinzette	90
ULRICH, Knochenhalte-zange	248
ULRICH, Kornzange	135
ULTA-LIGHT, Pinzette, atrauma	95
UNI I, Diagnostik-Besteck	13
UNI III, Diagnostik-Besteck	15
UNIVERSAL, Drahtschere	67
UNIVERSAL, Endoskophalterung	188
UNIVERSAL, Sterilisierzange	227
UNIVERSAL, Trokar	204
UNIVERSAL, Verbandschere	70
Universalgrieff, HUBER	472
Universelle Wundhakenhalterung f. Armsystem	188
UNNA, Komodonenquetscher	608
Unterbindungsnadel	218
Unterbindungsnadel, COOPER	219
Unterbindungsnadel, DESCHAMPS	218
Unterbindungsnadel, KRONECKER	219
Unterbindungsnadel, SCHMIEDEN-DICK	219
Unterkieferhaken, HARGIS	463, 463/6
Urethrotom, OTIS	553
Urinalschlüssel Female	621/2
USA Mod., Nabelschnurschere	64
USA MOD., Nabelschnur-Schere	64
USA Modell, Verbindungskabel	633
USA, anatomische Pinzette	81
US-ARMY, Wundhaken	141
Uterus-Biopsiezange, ALEXANDER	589
Uterus-Biopsiezange, BABY-TISCHLER	592
Uterus-Biopsiezange, BURKE	590
Uterus-Biopsiezange, BURKE-BABY	590
Uterus-Biopsiezange, EPPENDORFER	590
Uterus-Biopsiezange, KEVORKIAN	589, 591
Uterus-Biopsiezange, KEVORKIAN-PACIFIC	592
Uterus-Biopsiezange, MAXI GRASPER	593
Uterus-Biopsiezange, MINI-TOWNSEND-DOWN	591
Uterus-Biopsiezange, MINI-TOWNSEND-UP	591
Uterus-Biopsiezange, SCHUMACHER	589
Uterus-Biopsiezange, TISCHLER-DOWN	591
Uterus-Biopsiezange, TISCHLER-KEVORKIAN	592
Uterus-Biopsiezange, TISCHLER-MORGEN	590, 591
Uterus-Biopsiezange, TISCHLER-UP	591
Uterus-Biopsiezange, TOWNSEND	591
Uterus-Biopsiezange, WITTMER	589

Uterus-Depressor, BRAUN	586
Uterus-Depressor, SIMS	586
Uterusdilatorator, GOODELL	581
Uterus-Dilatator, GOODELL	581
Uterusdilatorator, HANK	580
Uterus-Dilatator, HANK	580
Uterus-Dilatator, HEGAR	578, 579
Uterusdilatorator, PRATT	580
Uterus-Dilatator, PRATT	580
Uterusdilatorator, SIMS	581
Uterus-Dilatator, SIMS	581
Uterus-Fasszange, COLLIN	585
Uterus-Fasszange, DARTIGUES	585
Uterus-Fasszange, SOMER	585
Uterus-Kürette, BLAKE	595
Uterus-Kürette, BUMM	597, 598
Uterus-Kürette, RECAMIER	597, 598
Uterus-Kürette, SIMS	597, 598
Uterus-Kürette, THOMAS	599
Uterus-Löffel, GOURDET	599
Uterus-Löffel, SCHRÖDER	595
Uterus-Löffel, SIMON	594
Uteruspolypenzange, DOYEN	585
Uteruspolypenzange, KELLY	585
Uteruspolypenzange, NOTO	585
Uterus-Sonde, COLLIN	586
Uterus-Sonde, MARTIN	586
Uterus-Sonde, SIMS	586
Uterus-Sonde, VALLEIX	586
Uterus-Zange, GREEN-ARMYTAGE	605

V

VALLEIX, Uterus-Sonde	586
Valve, Bauchdeckenhalter, BALFOUR	183
Valve, Bauchdeckenhalter, HORGAN	183
Valve, CASPAR, Cervicalspreizer	179, 180
Valve, CLOWARD, Cervicalspreizer	178/1 - 178/4
Valve, Scheidenspekula, O'SULLIVA-O'CONNOR	576
VAN BUREN, Dilatationsbougie	554
VAN BUREN, Knochenhalte-zange	249
VAN DOREN, Biopsiezange	588
VANNAS, Augenschere	79
VARADY, Varizeninstrument	202
Varizeninstrument, VARADY	202
Vasektomieklamme	553/1
Verbandschere	70
Verbandschere, BERGMANN	69/1
Verbandschere, BRUNS	70
Verbandschere, ESMARCH	69/2
Verbandschere, KNOWLES	70
Verbandschere, LISTER	69/1
Verbandschere, LORENZ	70
Verbandschere, REDA EXCENTER	69/2
Verbandschere, SEUTIN	69/2
Verbandschere, SMITH US ARMY	69/1
Verbandschere, UNIVERSAL	69/1
Verbandstofftrommel, SCHIMMELBUSCH	622
Verbindungskabel	633
VERBRÜGGE, Knochenhalte-zange	245
Verlängerungsrohr, BRUENINGS	472
Verlängerungsstück	298
Verstellbares Sägeblatt	230/7
VIENNA, Führungshohlsonde	221/1
VIRCHOW, Seziermesser	48
VIRTUS (RALK), Splitterzange	92
VOLKMANN, Doppellöffel	257
VOLKMANN, Knochenhaken	156
VOLKMANN, scharfer Löffel	251, 257
VOLKMANN, Wundhaken	153, 154, 156
VOLTOLINI, Nasenspekula	421
Vorböhrer, KUENTSCHER	321
VU-MORE, Scheidenspekula	569

W

WACHENFELDT, Wundklammerpinzette	224
WADSWORTH-TODD, Cauter	378
WAGENER, Häkchen	409
WAGENER-MOSHER, Trachealkanüle	477
WAGENSTEEN, Gefäßspinzette	89
WAGNER, Laminektomie-zange	343
WAGNER, SCHERE	67
WAGNER, Supercutscchere	72
WALDMANN, Episotomie-Schere	64
WALLICH, Abortuslöffel	607
WALSHAM, Septumtricht-zange	449
WALTHER, Dilator-Katheter	555
WALTON, Fingerring-säge	297
WALTON, Fremdkörperhohlmeißel	374
WALTON, Komodonenquetscher	608
Wangenhalter	453, 451
Wangenhalter, CAWOOD-MINNESOTA	451
Wangenhalter, STERNBERG	453
WANGENSTEEN, Nadelhalter	210
WARTENBERG, Nervrädchen	25
WATSON, Dermatoma	50
WATSON-CHEYNE, Elevator	283
WATSON-CHEYNE, Sonde	199
WATSON-WILLIAMS, Nasenzange	428
Wattedose	621
Watteträger, FARRELL	203
Watteträger, JOBSON-HORNE	203
Watteträger, REDA	203
Watteträger, TOBOLD	203
Watteträger, UCKERMANN	203
WAUGH, chirurgische Pinzette	83
WEBER, Aortaklemme	501
WEBER, Starschlinge	378
WEBSTER, Nadelhalter	208
Wechselpinzette, Blätter	179
WECKER, Augenschere	75
WECKER, Irisspatel	378
WEEK, Lidsperrerr	370
WEIL-BLAKESLEY, Nasenzange	426
WEITLANER, Wundspreizer	169
WEITLANER-WULLSTEIN, Wundspreizer	169
WELLER, Präparierschere	53/2
WELLS, Eukleationslöffel	378
WERTHEIM, gynäkologische Schere	62
WERTHEIM, Hysterektomieklamme	124, 128
WERTHEIM, Hysterektomieschere	63
WERTHEIM-CULLEN, Nierenstielklamme	125
WEST, Hohlmeißel	442/1
WEST, Nasenmeißel	442/1
WESTCOTT, Augenschere	75
WESTMACOTT, Nasentamponzange	324
WHEELER, Disziomsmesser	473
WHITE, Tonsillenzange	467
WIEDER, Zungendrucker	452
WIENER, Antrumraspel	443
WIENER, Irishäkchen	375
WIGMORE, Gipsmesser	229
WIKSTROEM, Arterienklamme	117
WILDE (TROELTSCH), Ohrpinzette	410
WILDE, Polypenschnürer	411, 433/2
WILDER, Starschlinge	378
WILDER, Tränenkanal-Dilatator	381
WILLET-MARTEL, Fasszange	110
WILLIAMS, Darmfasszange	539
WILLIAMS, Lidsperrerr	370
WILLIAMS, Schraubenzieher	323
WILLIGER, Hammer	271
WILLIGER, Raspator	276
WILLIGER, scharfer Löffel	255, 257
Winkelmesser, MOELTGEN	25
WINTER, Abortuszange	606
Wirbelkörperspreizer, CLOWARD	339

Wirbelkörperspreizer, INGE	339
WITTNER, Uterus-Biopsiezange	589
WOLFF, Gipsabreisszange	233
WOODSON, Dura-Dissektor	333
WORST, Sonde	381
WRIGLEY, Geburtszange	602
WULLSTEIN, Messer	418
WULLSTEIN, Mikro-Löffelzängchen	416
WULLSTEIN, Mikro-Ohrzängchen	416
WULLSTEIN, Sauggriff	338
WULLSTEIN, Wundspreizer	171
Wundhaken	463/3
Wundhaken mit treangle-griff	
LANGENBECK-MANNERFELT	148/4
Wundhaken mit treangle-griff	
MANNERFELT	148/3, 148/4, 148/5
Wundhaken, ALM	168
Wundhaken, ANDERSON	198
Wundhaken, AUFFRANC-COBRA	289
Wundhaken, BREAST	198
Wundhaken, BRUNNER	167
Wundhaken, COLLIN	139
Wundhaken, COLLIN-HARTMANN	141
Wundhaken, COOLEY	148
Wundhaken, CORONAL	198
Wundhaken, CORYLLOS	166
Wundhaken, CRILE	140
Wundhaken, CUSHING	151- 153
Wundhaken, CZERNY	141
Wundhaken, DAVIDSON	166
Wundhaken, DEAVER	145, 146
Wundhaken, DEAVER-GRIP	146
Wundhaken, DESMARRÉS	151
Wundhaken, DOYEN	163
Wundhaken, DOYEN-STILLE	167
Wundhaken, FARABEUF	139
Wundhaken, FERRIERA	197
Wundhaken, FINSEN	168
Wundhaken, FREEMAN	198
Wundhaken, FRITSCH	163
Wundhaken, GIL-VERNET	152
Wundhaken, GOELET	141
Wundhaken, GREEN	160
Wundhaken, HARGIS	463
Wundhaken, HARRINGTON	147
Wundhaken, HARRINGTON-PEMBERTON	147
Wundhaken, HASSON	143
Wundhaken, HEANEY	164
Wundhaken, HIBBS	164
Wundhaken, HOFER	465
Wundhaken, HOLZHEIMER	168
Wundhaken, HÖSEL	167
Wundhaken, ISRAEL	162
Wundhaken, JANSEN	168
Wundhaken, KELLY	164
Wundhaken, KELLY-GRIP	142
Wundhaken, KLAPP	150
Wundhaken, KOCHER	155, 159, 160, 163
Wundhaken, KOCHER-LANGENBECK	159
Wundhaken, KOERTE	162
Wundhaken, KÖNIG	153
Wundhaken, LAHEY	157
Wundhaken, LANGENBECK	158, 159
Wundhaken, LANGENBECK-GREEN	153
Wundhaken, LITTLE	157
Wundhaken, LOVE	465
Wundhaken, LUER	140
Wundhaken, MATHIEU	141
Wundhaken, MEYERDING	177
Wundhaken, MIDDELDORPF	160
Wundhaken, MIKULICZ	163
Wundhaken, MORRIS	164
Wundhaken, NAGER	465
Wundhaken, OBWEGESER	460, 461/1

Wundhaken, OLLIER	162
Wundhaken, PARKER	139
Wundhaken, RAGNELL	140
Wundhaken, RAMUS	461
Wundhaken, RICHARDSON	142
Wundhaken, RICHARDSON-EASTMAN	142
Wundhaken, RICHARDSON-GRIP	142
Wundhaken, ROSE	140
Wundhaken, ROSS	148/1
Wundhaken, ROUX	139
Wundhaken, ROUX-BABY	140
Wundhaken, ROUX-Mini	140
Wundhaken, SAUERBRUCH	164, 166
Wundhaken, SENN-GREEN	153
Wundhaken, SENN-MILLER	143
Wundhaken, SIMON	164
Wundhaken, SPINA-NASALIS	461
Wundhaken, St. MARKS	165
Wundhaken, STRANDELL-STILLE	157
Wundhaken, TEBBETTS	197
Wundhaken, TUFFIER	147
Wundhaken, US-ARMY/PARKER-LANGENBECK	141
Wundhaken, VOLKMANN	153, 154, 156
Wundhaken, YANCOSKIE	198
Wundhaken, ZENKER	161
Wundhakenhalterung	188
Wundklammerpinzette, MICHEL	224
Wundklammerpinzette, WACHENFELDT	224
Wundklammerzange, CHILDE	224
Wundklammerzange, COLLIN	224
Wundklammerzange, MICHEL	224
Wundklammerzange, RICHTER-HEATH	224
Wundnahtbesteck	225
Wundsperrer, ALM	168
Wundsperrer, CLOWARD	178/1 - 178/4
Wundsperrer, FINSEN	168
Wundsperrer, GELPI	189/2
Wundsperrer, HOLZHEIMER	168
Wundsperrer, JACKSON-BURROWS	189/2
Wundsperrer, JANSEN	168
Wundsperrer, RIGBY	189/2
Wundspreizer, ADSON	172 - 174
Wundspreizer, ADSON-BABY	173
Wundspreizer, ANDERSON-ADSON	172
Wundspreizer, BECKMANN	176
Wundspreizer, BECKMANN-ADSON	175
Wundspreizer, BECKMANN-EATON	176
Wundspreizer, BOSE	476
Wundspreizer, CASPAR	180
Wundspreizer, DARLING	178
Wundspreizer, HENLEY	170
Wundspreizer, MARTIN	175/1
Wundspreizer, MAYO-ADAMS	171
Wundspreizer, MEYERDING	180
Wundspreizer, MOLLISON	171
Wundspreizer, NORDFOLK/NORWICH	172
Wundspreizer, PERKINS	168
Wundspreizer, PLESTER	171
Wundspreizer, SCALP-CONTOUR	169
Wundspreizer, TRAVERS	172
Wundspreizer, WEITLANER	169
Wundspreizer, WEITLANER-WULLSTEIN	169
Wundspreizer, WULLSTEIN	169, 171
WYLIE, Aortaklemme	501/1
WYLIE, Uterus-Dilatator	581

Y

YANCOSKIE, Wundhaken	198
YANKAUER, Saugrohr	27
YASARGIL, Galeahaken	330
YASARGIL, Hirnspatelhalter	368
YASARGIL, Ohrspatelhalter	368/2
YASARGIL, SAUGROHR	337/1

YASARGIL, Spannarm	368/2
YASARGIL, Tumorzange	97
YEOMAN, Mastdarm-Biopsiezange	566
YOUNG, Prostatahaken	550
YOUNG, Zungenzange	453

Z

Zahnfleischschere, GOLDMAN-FOX	67
Zahnfleischschere, LA GRANGE	69, 72
Zahnfleischschere, LOCKLIN	67
Zahnfleischschere, QUINBY	69
Zahnpinzette, LONDON-COLLEGE	93
Zahnpinzette, MERIAM	93
Zange, ADAIR	582
Zange, ALEXANDER	589
Zange, ASCH	449
Zange, BABY-TISCHLER	592
Zange, BARRETT	582
Zange, BLAKE	530/2
Zange, BRAUN	582
Zange, BURKE	590
Zange, CHEVALIER-JACKSON	473
Zange, COLLIN	585
Zange, CZERNY	584
Zange, DARTIGUES	585
Zange, DESJARDINS	530/2
Zange, DOYEN	585
Zange, DUPLAY	582
Zange, EPPENDORFER	590
Zange, FAURE	588
Zange, GAUSS	605
Zange, GREEN-ARMYTAGE	605
Zange, HEIMING	536
Zange, HEYWOOD-SMITH	567
Zange, HULKA	583
Zange, IOWA	584
Zange, JACOBS	583
Zange, JARCHO	583
Zange, JURASZ	471
Zange, KELLY	585
Zange, KEVORKIAN	589, 592
Zange, KEVORKIAN-PACIFIC	592
Zange, MATHIEU	553/1
Zange, MAXI GRASPER	593
Zange, MAYO-BLAKE	530/2
Zange, MIXTER	530/2
Zange, MUSEUX	583
Zange, NOTO	585
Zange, POZZI-PALMER	582
Zange, PRATT	584
Zange, RANDALL	535
Zange, REDA	474
Zange, ROWE	459
Zange, SAENGER	606
Zange, SCHRÖDER	584
Zange, SCHRÖDER (POZZI)	582
Zange, SCHUBERT	588
Zange, SCHUMACHER	588, 589
Zange, SERPENTINE GRASPER	593
Zange, SKENE	582
Zange, SMITH	463
Zange, SOMER	585
Zange, TEALE	583
Zange, THOMAS-GAYLOR	588
Zange, TISCHLER-KEVORKIAN	592
Zange, TISCHLER-MORGAN	590
Zange, TOWNSEND	591
Zange, Van DOREN	588
Zange, WALSHAM	449
Zange, WINTER	606
Zange, WITTNER	589
Zange, YEOMANN	567
ZAUFAU, Ohrhebel	409

ZAUFAL-JANSEN, Hohlmeisselzange.....	238
ZAUFAL-JANSEN, Ohrhebel	409
ZEIGLER, Lidsperrer.....	371
ZENKER, Arterienklemme.....	118
ZENKER, Wundhaken.....	161
Zerlegbare Stanze, FERRIS-SMITH-KERRISON	344/2
ZIEGLER, Disziionsmesser.....	373
ZIEGLER, Irismesser.....	372
ZIEGLER, Stirnspiegel	21
ZIELKE, Hohlmeissel	264
Zirkular-Stanze	432
ZÖLLNER, Saugrohr.....	337/1
Zubehör f. Autopsiesäge	230/1 - 230/9
Zubehör f. Staubsauger u. Anlage	231/1
Zughaken, KIRSCHNER.....	313
Zughebel, BILL.....	604
Zughebel, LUIKART-BILL.....	604
Zugseil, NABATOFF.....	201
Zungendrucker, ANDREW	452
Zungendrucker, DAVIS-BOYLE	455
Zungendrucker, DINGMANN.....	456
Zungendrucker, HARTMANN.....	452
Zungendrucker, KILNER-DOUGHTY	456
Zungendrucker, MORITZ-SCHMIDT.....	452
Zungendrucker, TOBOLD	453
Zungendrucker, WIEDER.....	452
Zungenspatel.....	451
Zungenspatel DOYEN.....	451
Zungenspatel, BRUENINGS	451
Zungenspatel, BUCHWALD	451
Zungenspatel, DOUGHTY.....	458
Zungenspatel, FRENZEL	451
Zungenspatel, KROENIG.....	451
Zungenspatel, MAYO	451
Zungenspatel, MORITZ-SCHMIDT	452
Zungenspatel, RING.....	455
Zungenspatel, RUSSEL-DAVIS	458
Zungenzange, COLLIN	453
Zungenzange, YOUNG	453
Zwischenknochen-Messer.....	44
Zwischenstück, SCHULTZE Salpingograph.....	596
Zyklodialysespatel, CASTROVIEJO.....	379
Zyklodialysespatel, ELSCHNIG.....	379
Zyklodialysespatel, HIRSCHMANN.....	379

A

abdominal- a. intestinal spatula KÜMMEL 143/4, 144
 abdominal retractor KIRSCHNER 187, 187/1
 abdominal retractors BABY GOSSET 181
 abdominal retractors BALFOUR 182
 abdominal retractors BALFOUR Baby 182
 abdominal retractors BALFOUR-US 184
 abdominal retractors CHARNLEY 289
 abdominal retractors COLLIN 190
 abdominal retractors COLLIN-LOKTITE 191
 abdominal retractors DENIS-BROWNE 185
 abdominal retractors DOYEN 189/1
 abdominal retractors FRAZIER 181
 abdominal retractors GELPI 189/1
 abdominal retractors GOSSET 181
 abdominal retractors KIRSCHNER 187, 187/1
 abdominal retractors RICARD 191
 abdominal retractors RIGBY 189/2
 abdominal retractors ROCHARD 186
 abdominal spatula KADER 143/3
 abdominal spatula KOERTE 143/3
 abdominal spatula Leriche 143/4
 ABLI ophthalmologic scissors 58
 ABRAHAM tonsil forceps 468
 ABRAHAM tonsil knives 466
 accessories for autopsy saw 231/3
 ADAIR tenaculum forceps 582
 adenoid curette BARNHILL 450
 adenoid curette BECKMANN 450
 adenoid curette St. CLAIR-THOMSON 450
 adenoidectomy - tonsillectomy DRAFFIN 459
 adenoidectomy - tonsillectomy MAGAURAN 459
 Adenotom LA FORCE 450
 ADLERKREUTZ vascular tissue forceps 84
 ADSON retractors 173
 ADSON anatomic tissue forceps 81/2
 ADSON anatomic tissue forceps 81/2
 ADSON BABY hemostatic clamp 113
 ADSON bone rongeur 236
 ADSON dura hook 328
 ADSON hemostatic clamp 112
 ADSON holding clamp 298
 ADSON hypophyseal forceps 334
 ADSON MICRO anatomic tissue forceps 81/2
 ADSON MICRO surgical tissue forceps 81/2
 ADSON needle holder 211
 ADSON raspatories 282
 ADSON retractors 172, 173, 174
 ADSON suction tube 337
 ADSON surgical tissue forceps 81/2
 ADSON-BROWN tissue forceps 82
 ADSON-DEBAKEY atraumatic forceps 81/2
 AIR INJECTION eye cannula 394
 air pump 295
 ALAN-PARKS rectal specula 561
 ALDERDYCE elevator 282
 ALEXANDER biopsy forceps 589
 ALEXANDER chisels 259
 ALEXANDER raspatories 276
 ALLEN appendix intestinal clamp 544
 ALLIS intestinal grasping forceps 537
 ALLIS-ADAIR intestinal grasping forceps 537
 ALLIS-BABY intestinal grasping forceps 537
 ALLISON lung spatula 489/2
 ALM retractor 168
 ALVIS foreign body curette 374
 amniotome BEACHAM 586
 amputation knives CATLIN 44
 amputation knives LANGENBECK 44
 amputation knives LISTON 44
 amputation knives REDA 44
 amputation saw BIER 296
 amputation saw CHARRIERE 296

amputation saw SATTERLEE 296
 Anal retractor SMITH-BUIE 561
 anastomosis clamp BECK 516
 anastomosis clamp BECK 520
 anastomosis clamp COOLEY 519, 520 - 520/3
 anastomosis clamp COOLEY-DERRA 519
 anastomosis clamp DE MARTEL-WOLFSON 546-547
 anastomosis clamp DEBAKEY 505
 anastomosis clamp LAMBERT-KAY 505
 anatomic tissue forceps BROPHY 84
 anatomic tissue forceps 81
 anatomic tissue forceps ADSON 81/2
 anatomic tissue forceps ADSON Micro 81/2
 anatomic tissue forceps BONNEY 88
 anatomic tissue forceps CUSHING 83
 anatomic tissue forceps CUSHING-TAYLOR 87
 anatomic tissue forceps DUEHRSEN 84
 anatomic tissue forceps GERALD 86
 anatomic tissue forceps McINDOE 85
 anatomic tissue forceps POTTS-SMITH 81
 anatomic tissue forceps SEMKEN 86
 anatomic tissue forceps TAYLOR 87
 anatomic tissue forceps TC 81
 anatomic tissue forceps type USA 81
 anatomic tissue forceps STILLE 81
 ANDERSON ADSON retractors 172
 ANDERSON retractor 198
 ANDREW tongue depressor 452
 ANDREW-PYNCHON suction tube 28
 ANESTOPHON 23
 aneurysm clamp DEBAKEY-BAHNSON 506
 aneurysm clip applicator forceps 357 - 360
 anoscope HIRSCHMANN 562
 anoscope IVES-FANSLER 562
 Antrum curette COAKLEY 449
 Antrum rasp GALLAHER 446
 Antrum rasp LEWIS 443
 ANTRUM-curette 435
 ANVIL nail forceps 613
 aorta clamp WEBER 501
 aorta punch 528
 aortic clamp WYLIE 501/1, 501/2
 appendix clamp ALLEN 544
 applicator forceps aneurysm clip 357 - 360
 applicator forceps JOHNS-HOPKINS 104
 applicator forceps MC KENZIE 326
 applicator forceps MEHDORN 362
 applicator forceps SMITHWICK 326
 applying forceps RANEY 327
 Approximator BIEMER 366
 Approximator BIEMER-MÜLLER 363
 Approximator MÜLLER 364
 ARCHER splinter forceps 92
 armsystem 188
 ARRUGA capsular forceps 391
 ARRUGA eye specula 370
 ARRUGA needle holder 214
 ASCH septum straightening forceps 449
 atrauma bulldog clamp 100
 Atrauma bulldog clamp 100, 102
 atrauma clamp DEBAKEY 100
 atrauma clamp DEBAKEY 103
 atrauma clamp GLOVER 100
 atrauma neonatal clamp 523
 Atrauma-bulldog clamp GLOVER 103
 Atrauma-Bulldog Clamps GREGORY 100
 atraumatic forceps ADSON-DEBAKEY 81/2
 atraumatic forceps COOLEY 99
 atraumatic tissue forceps DEBAKEY 99
 AUFRANC retractor 289
 AUFRICHT nose hook 447
 AUFRICHT nose rasp 443
 Auricle clamp HARKEN 503
 autopsy knife 48

autopsy saw and accessories 230 - 230/9
 AUVARD vaginal specula 576
 awl 304
 awl HARGIS 463
 Awl OBWEGESER 463
 Awl OMBREDANNE 304
 awl PERTHES 304
 AYER chalazio tissue forceps 393

B

BABCOCK intestinal grasping forceps 539
 BABINSKI percussion mallet 24
 BABY BURKE biopsy forceps 590
 BABY GOSSET abdominal retractor 181
 BABY METZENBAUM supercut scissors 71
 BABY TISCHLER rongeur 592
 BABY WEBSTER needle holder 208
 BABY YANKAUER suction tube 27
 BABY-KOCHER intestinal clamp 540
 BABY-OLSEN-HEGAR needle holder 212
 Back holder Abdominal retractor system 192, 193, 194, 195
 BACKHAUS towel clamp 132
 BACKHAUS-clip 132
 BAILEY rib spreader 489/1
 BAILEY-BABY rib spreader 489/1
 BAILEY-GIBBON rib spreader 489/1
 BAINBRIDGE hemostatic clamp 120
 BAINBRIDGE vascular clamp 495/1, 495/2
 BAKES gall duct dilator 532
 BALFOUR abdominal retractors 182
 BALFOUR BABY abdominal retractors 182
 BALFOUR hook 193
 BALFOUR-US abdominal retractors 184
 BALL AND SOCKET towel clamp 133
 ball electrode MONOPOLAR 628, 629
 BALLENGER knives 436
 BALLENGER septum elevator 439
 BALLENGER tonsil forceps 467
 bandage scissors 70
 bandage scissors BERGMANN 69/1
 bandage scissors BRUNS 70
 bandage scissors ESMARCH 69/2
 bandage scissors KNOWLES 70
 bandage scissors LISTER 69/1
 bandage scissors LORENZ 70
 bandage scissors REDA EXCENTER 69/2
 bandage scissors SEUTIN 69/2
 bandage scissors SMITH US ARMY 69/1
 bandage scissors UNIVERSAL 70
 BANE-HARTMANN bone rongeur 237
 BARACANI interchangeable tips 472
 BARBARA hook 419
 BARBARA needle 419
 BARNHILL adenoid curette 450
 BARON scution tube 356
 BARR rectal-specula 559
 BARRAQUER clia forceps 395
 BARRAQUER eye scissors 75
 BARRAQUER eye specula 370
 BARRAQUER fixation forceps 390
 BARRAQUER knives 373
 BARRAQUER needle holder 216, 217
 BARRAQUER-KATZIN iris tissue forceps 384
 BARRET hook forceps 582
 BARRON Scalpel Handles 38
 battery handle for cold light 33
 battery handle for warm light 32
 BAUMGARTNER needle holder 208
 BEACHAM amniotome 586
 BECK anastomosis clamp 520
 BECK vascular clamp 516
 BECKER cystotome 375

BECKMANN adenoid curette.....	450	blade breaker TROUTMAN-CHRIS.....	45	bone levers KOENIG.....	284
BECKMANN retractors.....	176	blade ejecting forceps.....	179	Bone Levers LAMBOTTE.....	287
BECKMANN-ADSON retractors.....	175	blades razor.....	45	bone levers LANGE-HOHMANN.....	286
BECKMANN-EATON retractors.....	176	BLAKE gall stone forceps.....	530/2	bone levers SMILLIE.....	291
bed pan.....	621/1	BLAKE uterine curette.....	595	bone plate holding forceps LANE.....	325
BEEBEE crown scissors.....	68	BLOHMKE tonsil forceps.....	467	bone rasp.....	294
BEER cilia forceps.....	395	blood vessel clamp DIETRICH.....	510	bone rasp PUTTI.....	294
BEESON plaster retractor.....	232	blood vessel clamp MORRIS-DEBAKEY.....	506	bone regeu rLEKSELL-STILLE.....	240
BELLUCCI micro ear scissors.....	413	BLOUNT bone levers.....	288, 289	bone regeu ADSON.....	236
BELLUCCI micro scissors.....	417	BLUMENTHAL bone regeu.....	236	bone regeu BANE-HARTMANN.....	237
bender LANE.....	325	BOENmallet rectal specula.....	559	bone regeu BEYER.....	237, 238
BENGOLEA hemostatic clamp.....	112	BOEHLER extension bow.....	312	bone regeu BLUMENTHAL.....	236
BENNETT bone levers.....	283	BOETTCHER tonsil scissors.....	59	bone regeu BOEHLER.....	238
BENSAUDE proctoscope.....	565	BÖHLER bone cutting forceps.....	241	bone regeu CLEVELAND.....	235
BENSON pylorus retractor.....	544	BÖHLER bone regeu.....	238	bone regeu ECHLIN.....	240
BERENS discision knives.....	372	BOIES elevator.....	277	bone regeu FRIEDMAN-MICRO.....	234
BERGMANN bandage scissors.....	69/1	BONACCOLTO strabismus forceps.....	385	bone regeu FRIEDMAN-MINI.....	234
BERGMANN mallet.....	272	bone curettes.....	255, 256	bone regeu FRYKHOLM.....	240
BERKE muscle forceps.....	389	bone curettes BRUNS.....	251, 254	bone regeu JANSEN.....	237
BERLINER percussion mallet.....	24	bone curettes BUSHE.....	256	bone regeu KLEINERT-KUTZ.....	237
BERNHARD towel clamp.....	133	bone curettes DAUBENSPECK.....	255	bone regeu LEMPERT.....	237
BERRY wire forceps.....	319	bone curettes HALLE.....	253	bone regeu LUER.....	236
BETHUNE rib scissors.....	481	bone curettes JACOBSON.....	257	bone regeu MARQUARD.....	239
BEYER bone regeu.....	237, 238	bone curettes JANSEN.....	257	bone regeu MAYFIELD.....	238
BIEMER approximator.....	366	bone curettes LEMPERT.....	256	bone regeu MEAD.....	235
BIEMER vascular clip.....	361	bone curettes MARTINI.....	257	bone regeu OLIVECRONA.....	237
BIEMER-MÜLLER approximator.....	363	bone curettes SCHEDE.....	251	bone regeu RUSKIN.....	239
BIER amputation saw.....	296	bone curettes SCOVILLE.....	253	bone regeu SAUERBRUCH.....	240
BILLEAU ear loop.....	409	bone curettes SPINAL.....	253	bone regeu SCAGLIETTI.....	240
biopsy curette HEANY.....	587	bone curettes SPRATT.....	251	bone regeu SEMB.....	240
biopsy curette KEVORKIAN.....	587	bone curettes VOLKMANN.....	251, 257	bone regeu SMITH-PETERSEN.....	238
biopsy curette NOVAK.....	587	bone curettes WILLIGER.....	255, 257	bone regeu STELLBRINK.....	234
biopsy curette RANDALL.....	587	bone cutting forceps BOEHLER.....	241	bone regeu STILLE-LUER.....	239
biopsy curette type MÜNCHEN.....	587	bone cutting forceps COTTLE-KAZANJIAN.....	241	bone regeu STILLE-RUSKIN.....	239
biopsy forceps ALEXANDER.....	589	bone cutting forceps LISTON.....	241	bone regeu ZAUFAL-JANSEN.....	238
biopsy forceps BABY BURKE.....	590	bone cutting forceps McINDOE.....	241	bone wire soft.....	314
biopsy forceps BURKE.....	590	bone cutting forceps RUSKIN.....	241	BONN iris tissue forceps.....	387
biopsy forceps EPPENDORFER.....	590	bone cutting forceps SEMB.....	242	BONNEY anatomic tissue forceps.....	88
biopsy forceps FAURE.....	588	bone cutting forceps STILLE-HORSLEY.....	242	BONNEY surgical tissue forceps.....	88
biopsy forceps KEVORKIAN.....	589	bone cutting forceps STILLE-LISTON.....	242	BOSE trachea hook.....	476, 477
biopsy forceps KEVORKIAN.....	591	bone hand drills BUNELL.....	299	BOUCHERON ear specula.....	399
biopsy forceps KEVORKIAN-PACIFIC.....	592	bone hand drills HUDSON.....	298	BOWMAN discision needle gerade.....	374
biopsy forceps MAXI GRASPER.....	593	bone hand drills RALK.....	299	BOWMAN eye specula.....	370
biopsy forceps SCHUBERT.....	588	bone holding clamp FELDHEIM.....	249	BOWMAN lachrymal probes.....	381
biopsy forceps SCHUMACHER.....	588, 589	bone holding clamp GERSTER.....	250	Box PETRI.....	620
biopsy forceps THOMAS-GAYLOR.....	588	bone holding clamp LAMBERT-LOWMAN.....	249	BOYNTON needle holder.....	214
biopsy forceps TISCHLER-DOWN.....	591	bone holding clamp LOWMAN.....	249	BOZEMANN dressing forceps.....	138
biopsy forceps TISCHLER-KEVORKIAN.....	592	bone holding clamp LOWMAN-HOGLUND.....	249	BOZEMANN needle holder.....	211
biopsy forceps TISCHLER-MORGAN.....	591	bone holding forceps.....	249	BOZEMANN-DOUGLAS dressing forceps.....	138
biopsy forceps TOWNSEND MINI.....	591	bone holding forceps BIRCHER-GANSKE.....	246	brain knives.....	48
biopsy forceps TOWNSEND TISCHLER MINI.....	591	bone holding forceps DINGMANN.....	246	brain spatula CUSHING.....	336
biopsy forceps VAN DOREN.....	588	bone holding forceps FARABEUF.....	243	brain spatula CUSHING.....	369
biopsy forceps WITTNER.....	589	bone holding forceps FARABEUF-L.AMBOTTE.....	243	brain spatula DAVIS.....	337
biopsy forceps TISCHLER-MORGAN.....	590	bone holding forceps FERGUSSON.....	243	brain spatula HEIFETZ.....	369
biopsy needle MENGHINI.....	206	bone holding forceps KERN.....	244	brain spatula OLIVECRONA.....	336
biopsy-suction curette.....	600	bone holding forceps LAMBOTTE.....	244	BRAND tendon grasping instrument.....	293
bipolar cable.....	633	bone holding forceps LANE.....	244	BRAND tendon passing instrument.....	294
Bipolar connecting cables.....	633	bone holding forceps LANGENBECK.....	243	BRUN cranoplast.....	607
bipolar tissue forceps.....	630, 631	bone holding forceps LEWIN.....	246	BRUN decapitating hook.....	607
Bipolar-tissue forceps bajonett.....	632	bone holding forceps MEYER.....	248	BRUN hook forceps.....	582
BIRCHER-GANSKE bone holding forceps.....	246	bone holding forceps REDA.....	246, 247	BRUN uterine-Depressor.....	586
BIRKETT hemostatic clamp.....	116	bone holding forceps REILL.....	248	BRUN-STADLER episotomy scissors.....	64
BISHOP-HarmAN iris tissue forceps.....	386	bone holding forceps SEMB.....	243	BREAST retractor.....	198
BISHOP-HarmAN irrigation cannula.....	394/1	bone holding forceps ULRICH.....	248	BREISKY vaginal specula.....	577
Bladder Retractors HRYNTSCHAK.....	553	bone holding forceps VAN BUREN.....	249	BRIDGE hemostatic clamp.....	116
bladder retractors LEGUE.....	553	bone holding forceps VERBRUGGE.....	245	BRISTOW bone levers.....	290
bladder retractors MILLIN.....	552	bone hook VOLKMANN.....	156	BRODIE probes.....	199
bladder retractors THOMSON-WALKER.....	552	bone levers.....	284, 288	Broncho.forceps CHEVALIER-JACK.....	473
bladder retractors JUDD-MASSON.....	552	bone levers BENNETT.....	283	bronchus clamp.....	126
bladder spatula KOCHER.....	552	bone levers BLOUNT.....	288	bronchus clamp FINOCCHIETTO.....	490
bladder spatula LEGUEU.....	552	Bone Levers HAYES.....	284	bronchus clamp HARRINGTON.....	490
bladder spreader MILLIN.....	553	bone levers HOHMANN.....	284	bronchus clamp LEES.....	504
blade breaker CASTROVIEJO.....	45	bone levers HOHMANN.....	285	bronchus clamp PRICE-THOMAS.....	490
blade breaker REDA.....	45	bone levers HOHMANN Mini.....	286	bronchus clamp SEMB.....	491

BROPHY anatomic tissue forceps	84
BROPHY surgical tissue forceps	84
BROWN needle holder	209
BROWN tissue forceps	83
BRUENINGS ear specula	401
BRUENINGS interchangeable tips	472
BRUENINGS septum forceps	425
BRUENINGS tongue depressors	451
BRUENINGS tonsil knives	466
BRUENINGS tonsil snare	468
BRUNETTI chisels	268
BRUNINGS-LUCAS chisels	260
BRUNNER guideprobes	221/1
BRUNNER intestinal clamp	543
BRUNNER retractor	167
BRUNNER rib scissors	481
BRUNS bandage scissors	70
BRUNS bone curettes	251, 254
BRYANT dressing forceps	137
BUCHWALD tongue depressors	451
BUCK ear curette	407
BUCK foreign body lever	412
BUCK percussion mallet	24
BUCK-GRAMCKO bone levers	285
BUIE rectal suction tube	566
BULLDOG clamp atrauma	100
BULLDOG clamp DEBAKEY	100, 103
bulldog clamp DIETRICH	101
bulldog clamp GLOVER	103
bulldog clamp JOHNS-HOPKINS	104
BÜLOW-GUNAR-HEY tubing clamp	130
BUMM uterine curette	597
BUNELL bone hand drills	299
BUNELL tendon guide	294
BUNELL tendon passing instr.	292
BUNGE scoop	378
BUNT sterilization clamp	227
BURCH fixation forceps	373
BURKE biopsy forceps	590
BUSCH episiotomy scissors	64
BUSHE bone curette	256

C

cable bipolar	633
caliper TOWNLEY	26
CANFIELD tonsil knives	466
CAPLAN nose forceps	428
capsula scissors RESANO	53/2
capsular forceps ARRUGA	391
capsular forceps CASTROVIEJO	391
capsular forceps ELSCHNIG	391
capsular forceps FUCHS	391
capsular forceps GILL-ARRUGA	390
capsular forceps HESS	391
capsular forceps KALT	391
capsular forceps SCHWEIGGER	391
capsular forceps TERSON	391
capsular grasping forceps MILLIN	551
cardiovascular clamps	526
CarmALT splinter tissue forceps	91
CAROLL tendon grasping instrument	293
Carotid shunt clamp JAVID	511
CARPENTER tonsil knives	465
CARTILAGE knives	47
CASPAR hemostats	258
CASPAR retractors	179, 180
CASTANEDA Neonatal vascular clamp	527
CASTROVIEJO	79, 381
CASTROVIEJO bladeBREAKER	45
CASTROVIEJO capsular forceps	391
CASTROVIEJO cyclodialysis spatula	379
CASTROVIEJO eye specula	371
CASTROVIEJO fixation forceps	390

CASTROVIEJO hornsinscissors	79
CASTROVIEJO Measurance circle	380
CASTROVIEJO needle holder	215
CASTROVIEJO tissue forceps	392
CASTROVIEJO-MICRO needle holder	215
CASTROVIEJO-STANDARD needle holder	216
cataract curette DAVIEL	377
cataract curette GRAEFE	377
cataract curette KNAPP	378
cataract knives DEUTSCHMANN	371
cataract knives GRAEFE	371
cataract loop SNELLEN	378
cataract loop WEBER	378
cataract loop WILDER	378
CATETHER INTRODUCING FORCEPS MAGILL	28
catheter forceps COOLEY	510
catheter guide GUYON	554
catheter WALTHER	555
CATLIN amputation knives	44
cauter WADSWORTH-TODD	378
cervica retractor CLOWARD	178/1, 178/2, 178/3, 178/4
cervical traction tong CRUTCHFIELD	327
chalazio curette HEBRA	377
chalazio curette MEYHOEFER	377
chalazio tissue forceps AYER	393
chalazio tissue forceps DESMARRS	393
chalazio tissue forceps LAMBERT	393
CHAPUT tissue grasping forceps	110
Charger for handles	34/1
CHARNLEY abdominal retractor	289
CHARRIERE amputation saw	296
CHEATLE sterilization forceps	227
cheek retractor STERNBERG	453
cheekSTEIN needle holder	210
CHELSEA-EATON proctoscope	563
CHERON dressing forceps	137
CHERRY laminectomy retractor	488
CHEST SUPPORT KLEINSASSER	36
chest support LEWY	37
CHEVALIER-JACKSON	473
CHEVALIER-JACKSON trachea cannula	479
CHILDE clip forceps	224
children atrauma vascular clamp	526
chisel NEIVERT-ANDERSON	442
chisels	259, 264
chisels ALEXANDER	259
chisels blade	266
chisels BRUNETTI	268
chisels COTTLE	440
chisels HIBBS	265
chisels HOKE	265
chisels Killian	442/1
chisels LAMBOTTE	261
chisels LEXER	263
chisels MINI-LAMBOTTE	262
chisels NOVOTEX	264
chisels OBWEGESER	463
chisels SMITH-PETERSEN	261
chisels STILLE	260
CHRISTOPHE Hemostatic Forceps	107
cilia forceps BARRAQUER	395
cilia forceps BEER	395
cilia forceps DOUGLAS	395
cilia forceps GRADLE	395
cilia forceps LITTAUER	395
cilia forceps REDA	395
CINELLI septum chisels	441
circular rongeur	432
CIRCUMCISIONS instrument	556
CITELLI rongeur	430
clamp Vasektomie	553/2
CLAR HEAD LIGHTS	22
CLARK eye specula	370
CLAUS tonsil needle	466

CLAYMAN	376
Clayman hook	376
cleaning pistol	626
CLEVELAND bone rongeur	235
clip forceps CHILDE	224
clip forceps COLLIN	224
clip forceps RICHTER-Health	224
clip tissue forceps MICHEL	224
clip tissue forceps WACHENFELDT	224
clip-applier forceps	523, 524
CLOWARD lamina spreader	339
CLOWARD laminectomy retractor forceps	342
CLOWARD retractors	178/1, 178/2, 178/3, 178/4
COAKLEY ANTRUM curette	449
COAKLEY trocar	204
COBB curette	252
COBB gouges	262
COBB raspatories	280
COLCLOUGH intervertebral disc rongeur	344/1
COLLER-CRILE hemostatic clamp	106
COLLIER needle holder	208
COLLIER pelvimeter	605
COLLIN abdominal retractor	190
COLLIN clip forceps	224
COLLIN dressing forceps	137
COLLIN DYNAMOMETER	25
COLLIN intestinal grasping forceps	539
COLLIN LOKTITE abdominal	191
COLLIN mallet	270
COLLIN navelstringclamp	605
COLLIN pelvimeter	605
COLLIN retractor	139
COLLIN Rib shears	480
COLLIN scalpel-handle	40
COLLIN tissue grasping forceps	110
COLLIN tongue forceps	453
COLLIN uterine-grasping forceps	585
COLLIN uterine-probes	586
COLLIN vaginal specula	870
COLLIN-DUVAL grasping PINZE	575
COLLIN-HARTMANN retractor	141
Columella tissue forceps COTTLE	448
COLVER tonsil forceps	467
comedone extractor SAALFELD	608
comedone extractor SCHAMBERG	608
comedone extractor UNNA	608
comedone extractor WALTON	608
compression bandage	296
CONE curette	280
CONE head punch	331
CONE raspatories	280
connecting cables bipolar	633
CONVERSE nose hook	448
CONVERSE septum knives	435
COOLEY anastomosis clamp	519, 520 - 520/3
COOLEY atraumatic tissue forceps	99
COOLEY catheter forceps	510
COOLEY retractor	148
COOLEY rib spreader	487
COOLEY vascular clamp	518, 522
COOLEY-DERRA anastomosis clamp	519
COOLEY-NEONATAL rib spreader	485
COOLY suction tube	28
COOPER ligaturee needle	219
CORDES interchangeable tips	472
corneal dissector GREEN	374
corneal dissector PATON	373
corneal scarifier GILL	373
corneal scarifier TOOK	373
CORONAL BROW retractor	198
CORWIN-HEGAR wire forceps	319
CORYLLOS retractor	166
CORYLLOS rib scissors	480
COS micro ear forceps	414

COTTLE columella tissue forceps.....	448	DARLING retractors	178	Diagnostic set UNI III	15
COTTLE fixation forceps	410	DARTIGUES uterine grasping forceps.....	585	Diagnostic set UNI I	13
COTTLE mallet.....	273	DASTOOR strabismus forceps	386	DIEFFENBACH vascular clamp	104
COTTLE nose hook.....	447, 447/1	DASTOOR suction tube	380	DIETER micro ear forceps	414
COTTLE nose scissors	59	DAUBENSPECK bone curettes	255	DIETRICH blood vessel clamp	510
COTTLE nose specula	423	DAVIDSON(SCAPULA) retractor	166	DIETRICH MINI-bulldog clamp	101
COTTLE scissors	56	DAVIEL cataract curette.....	377	DIETRICH vascular scissors	60
COTTLE septum chisels	440	DAVIS brain spatula	337	dilating bougie OTIS	554
COTTLE septum elevator.....	439	DAVIS dura dissector	379	dilation bougie DITTEL	554
COTTLE septum knives	435	DAVIS sterilization tissue forceps	227	dilation bougie GUYON	554
COTTLE skin hook	447, 448	DAVIS-BOYLE.....	455	dilation bougie VAN BUREN.....	554
COTTLE-JOSEPH septum.....	439	DAVIS-BOYLE SPERRE.....	455	DINGMANN bone holding forceps	246
COTTLE-KAZANJIAN bone cutting forceps.....	241	DAVIS-MEYER mouth gag.....	457	DINGMANN mouth gag	456
COTTLE-NEIVERT	448	DAY hook	409	DINGMANN raspatories	463
cotton-applicator	203	DE BAKEY / GARRETT vascular-dilator.....	529	DINGMANN retractor	463
cotton-applicator FARRELL	203	DE BAKEY needle holder	210	DINGMANN spreader.....	456
cotton-applicator JOBSON-HORNE	203	DE BAKEY Rib Spreaders.....	485/1	discision knives BERENS.....	372
cotton-applicator REDA.....	203	DE BAKEY SATINSKY Dissecting and Ligature clamps.....	504/1	discision knives JAEGER.....	372
cotton-applicator TOBOLD	203	DE BAKEY vascular clamp	493-500, 502, 505-508, 512-517	discision knives WHEELER.....	373
cotton-applicator UCKERMANN.....	203	DE BAKEY vascular scissors	60, 61	discision knives ZIEGLER	373
COXETER METAL catheter	555	DE BAKEY vascular scissors	60, 61	discision needle	374
CRAFOOD-SELLORS hemostatic clamp.....	118	DE LEE obstetrical forceps	602	discision needle BOWMAN	374
CRAFOOD hemostatic clamp	118	DE MARTEL guide sleeve	330	disimpaction forceps ROWE	459
CRAFOOD lung scissors	65/2	DE MARTEL-WOLFSON	546-547	Dissecting- and Ligature clamps	
CRAIG Nasal Cutting Forceps	426	DEAN iris knives	372	DE BAKEY SATINSKY	504/1
cranoplast BRAUN	607	DEAN tonsil scissors	59	Dissecting and Ligature Forceps	128/2
CREGO elevator	282	DEAVER dissecting scissors.....	52	dissecting scissors	52, 52/1, 53
CRILE hemostatic clamp	107	DEAVER retractor	145	dissecting scissors DEAVER.....	52
CRILE needle holder	213	DEAVER-GRIP retractor	146	dissecting scissors JORGENSEN.....	53
CRILE nerve hook	328	DEBAKEY aortic clamp	505	dissecting scissors LEXER	53
CRILE retractor	140	DeBaKey atrauma bulldog clamp.....	100, 103	dissecting scissors LEXER-BABY.....	53
CRILE-MURRAY needle holder	209	DEBAKEY atrauma clamp	100	dissecting scissors LEXER-BABY TC.....	53
CRILE-RANKIN hemostatic clamp	107	DEBAKEY atrauma clamp	103	dissecting scissors MAYO	52/1
CRILE-WOOD needle holder	209	DEBAKEY atraumatic tissue forceps	99	dissecting scissors MAYO TC	52/1
crown scissors BEEBEE	68	DEBAKEY retractor	189/1	dissecting scissors MAYO-NOBLE	52/1
CRUTCHFIELD head holder.....	327	DEBAKEY suction tube	28	dissecting scissors MAYO-STILLE	52/1
CRUTCHFIELD cervical traction tong.....	327	DEBAKEY vascular clamp ...	493-500, 502, 505-508, 512-517	Dissecting Scissors METZENBAUM.....	53/3, 53/4
cuff for leg	295	DEBAKEY vascular scissors	61	dissecting scissors METZENBAUM	53/1
cuff for upper arm	295	DEBAKEY vascular scissors TC	60	dissecting scissors METZENBAUM FINO	53/1
cup medicine	621	DEBAKEY-BAHNSON aneurysm clamp	506	dissecting scissors METZENBAUM FINO TC.....	53/1
cup sputum	621/1	DEBAKEY-DIETRICH MINI BULLDOG clamp	101	dissecting scissors METZENBAUM TC	53/1
curette Antrum	435	DEBAKEY-MIXTER vascular clamp	499/2	dissecting scissors METZENBAUM TC	53/1
curette Cobb	252	DEBAKEY-MOSQUITO hemostatic clamp.....	509	dissecting scissors PECK-JOSEPH	74
curette FAULKNER	449	DEBAKEY-PEAN atrauma clamp	513	dissecting scissors TOENNIS-ADSON	65
curette forceps.....	416	DEBAKEY-RANKIN atrauma clamp	512	dissector FISCH	420
curette HOUSE	420	DEBAKEY-RUMEL vascular clamp	499	dissector GORNEY	277
CUSCO vaginal specula	570	Decapitating hook BRAUN	607	dissector PENFIELD	333
Cushing (Taylor) tissue forceps TC.....	87	DECKER rongeur	341	DITTEL dilation bougie	554
CUSHING anatomic tissue forceps.....	83	DEJERINE percussion mallet.....	24	DIX foreign body chisels	374
CUSHING brain spatula	336, 369	Delee retractor	574	DIX foreign body instrument.....	380
CUSHING drill	298	delicate bipolar scissors.....	634	double curette VOLKMANN	257
CUSHING laminectomy retractor forceps	340	DEMEL wire guide needle.....	315	DOUGHTY tongue blade	458
CUSHING nerve ENhook	328	DEMEL wire instrument.....	315	DOUGLAS cilia forceps	395
CUSHING retractor	152	DENHART mouth gags	454	DOUGLAS trocar	204
CUSHING retractor	153	DENIS- BROWNE Dressing and Tissue Forceps	89	DOYEN abdominal retractor	189/1
CUSHING retractor	151, 152, 153	DENIS-BROWNE abdominal retractors	185	DOYEN gynecological scissors.....	63
CUSHING surgical tissue forceps	83	depth ruler	594	DOYEN intestinal clamp	540
CUSHING tissue forceps	87	DERF needle holder	208	DOYEN Mallets	271
CUSHING-TAYLOR anatomic tissue forceps	87	Dermatom HUMBY	50	DOYEN myoma a screw	594
CUZZI ovum curette	606	Dermatom SILVER	50	DOYEN probes	199
cyclodialysis spatula CASTROVIEJO	379	Dermatome SCHINK	49	DOYEN raspatories	278
cyclodialysis spatula ELSCHNIG	379	dermatome blade	49	DOYEN retractor	163
Cystotom BECKER	375	DESCHAMPS ligaturee needle	218	DOYEN scissors	63
Cystotom GRAEFE	375	DESJARDINS gall stone curette	534	DOYEN Tongue Depressors	451
CZERNY hook forceps	584	DESJARDINS gall stone forceps	530/2	DOYEN towel clamp	133
CZERNY rectal-specula	559	DESJARDINS gall stone probe	531	DOYEN uterine polyp forceps	585
CZERNY retractor	141	DESJARDINS hemostatic clamp.....	121	DOYEN vaginal specula.....	574
		DESMARRES chalazio tissue forceps	393	DOYEN-BABY intestinal clamp	540
		DESMARRES retractor	151	DOYEN-JANSEN(MOLT)	454
		DEUTSCHMANN cataract knives	371	DOYEN-JANSEN(MOLT) mouth gags	454
		DEVILBISS head forceps	332	DOYEN-STILLE.....	167
		Diagnostic set ECO „T“	16	DRAFFIN adenoidectomy - tonsillectomy	459
		Diagnostic set RI-MINI	17	Dressing and Tissue Forceps DENIS- BROWNE	89
				dressing forceps BOZEMANN	138

D

dressing forceps BOZEMANN-DOUGLAS.....	138
dressing forceps BRYANT.....	137
dressing forceps CHERON.....	137
dressing forceps COLLIN.....	137
dressing forceps FOERSTER.....	136
dressing forceps GROSS-MAIER.....	134
dressing forceps LISTER (SINUS).....	137
dressing forceps MAIER.....	134
dressing forceps PELKMANN.....	137
dressing forceps RAMPLEY.....	136
dressing forceps SIMS-MAIER.....	134
dressing forceps ULRICH.....	135
dressing tissue forceps JACKSON.....	471
drill bits.....	302
drill CUSHING.....	299
drill ERRICO.....	298
drill MC KENZIE.....	298
drill wire.....	299
drills.....	299
drillwire KIRSCHNER.....	306, 307
driver KUENTSCHER.....	321
drivers.....	321
drums SCHIMMELBUSCH.....	622
DUBOIS gynecological scissors.....	63
DUEHRSEN anatomic tissue forceps.....	84
DUPLAY dressing forceps.....	134
DUPLAY hook forceps.....	582
DUPLEX stethoscope.....	23
DUPUY-WEISS tonsil knives.....	466
dura dissector.....	332
dura dissector DAVIS.....	332
dura dissector FRAZIER.....	333
dura dissector HOEN.....	333
dura dissector HORSLEY.....	333
dura dissector MILLIGAN.....	332
dura dissector OLIVECRONA.....	332
dura dissector SACHS.....	332
dura dissector TOENNIS.....	332
dura dissector WOODSON.....	333
dura hook.....	335
dura hook ADSON.....	328
dura hook JACOBSON.....	335
dura knives KOOS.....	335
dura scissors SCHMIEDEN-TAYLOR.....	65/1
durante grasping tissue forceps.....	88
DUVAL grasping tissue forceps.....	85
DUVAL intestinal grasping forceps.....	539
Dynamometer COLLIN.....	25

E

ear catheter HARTMANN.....	408
ear curette BUCK.....	407
ear curette GROSS.....	409
ear forceps HARTMANN.....	411
ear forceps HEYMANN-KNIGHT.....	425
ear forceps JANSEN.....	424
ear forceps LITTAUER.....	411
ear forceps LUCAE.....	410
ear forceps TILLEY.....	411
ear forceps TROELTSCH.....	424
ear forceps WILDE (TROELTSCH).....	410
ear knives POLITZER.....	408
ear knives SEXTON.....	408
ear lever ZAUFAL.....	409
ear lever ZAUFAL-JANSEN.....	409
ear loop BILLEAU.....	409
ear loop SHAPLEIGH.....	410
ear specula BOUCHERON.....	399
ear specula BRUENINGS.....	401
ear specula GRUBER.....	399
ear specula HARTMANN.....	399
ear specula POLITZER.....	399
ear specula SIEGLE.....	402

ear specula TOYNBEE.....	399
ear syringe REINER.....	407
ECHLIN bone rongeur.....	240
ECO "T" Diagnostic set.....	16
EICKEN (KILLIAN) irrigation cannula.....	433
elevator ALDERDYCE.....	282
elevator BOIES.....	277
elevator CREGO.....	282
elevator DINGMANN.....	463, 463/3
elevator FREER.....	434
elevator KEY.....	282
elevator LUNIATSCHEK.....	465
elevator McDONALD.....	283
elevator MURPHY-LANE.....	283
elevator SAYRE.....	281
elevator WATSON-CHEYNE.....	283
ELLIOT obstetrical forceps.....	603
ELSCHING capsular forceps.....	391
ELSCHING corneal scarifier.....	373
ELSCHING cyclodialysis spatula.....	379
ELSCHING fixation forceps.....	389
EMMETT fistula hook.....	594
ENDErmail STEINMANN.....	307
endoscop eassembly.....	188
Endospecula KOGAN.....	577
ENGEL plaster cast saw.....	229
enterotomy scissors.....	66
Entropium forceps SNELLEN.....	393
enuclation curette WELLS.....	378
ENUCLEATION scissors.....	58
epiglottis retractor FRAENKEL.....	471
epiglottis retractor JACKSON.....	471
episotomy scissors WALDMANN.....	64
EPPKER osteotome.....	464/2
EPPENDORFER biopsy forceps.....	590
ERICH wire pusher.....	461/2
ESMARCH bandage scissors.....	69/2
ESMARCH plaster knives.....	233
ETHICON clip forceps.....	524
EVES tonsil snare.....	468
Exenteration curette BUNGE.....	378
Extension piece.....	298
extensions bows BOEHLER.....	312
extensions bows KIRSCHNER.....	312
extensions bows KIRSCHNER US.....	312
extirpation chisels ROLLET.....	374
extraction dissector LANG.....	378
extraction hook KNAPP.....	375
extraction hook ROLLET.....	375
extractor KUENTSCHER.....	322
eye cannula MCINTYRE.....	394
eye cannula type AIR INJECTION.....	394
eye cannula type SHEETS.....	394/2
eye magnet REDA.....	395
eye scissors BARRAQUER.....	75
eye scissors NOYES.....	75
eye scissors VANNAS.....	79
eye scissors WECKER.....	75
eye scissors WESTCOTT.....	75
eye specula ARRUGA.....	370
eye specula BARRAQUER.....	370
eye specula BOWMAN.....	370
eye specula CASTROVIEJO.....	371
eye specula CLARK.....	370
eye specula GRAEFE.....	370
eye specula LANCASTER.....	371
eye specula MELLINGER.....	370
eye specula MUELLER.....	371
eye specula MURDOCK.....	370
eye specula PARK.....	370
eye specula WEEK.....	371
eye specula WILLIAMS.....	370
eye specula STEVENSON.....	371
eye suction -irrigation cannula.....	394

F

Face Lift scissors FREEMAN.....	74
Face Lift scissors GORNEY.....	73
Face Lift scissors KAYE.....	73
Face Lift scissors REES.....	73
FANSLER proctoscope.....	564
FARABEUF bone holding forceps.....	243
FARABEUF raspatoriesies.....	274
FARABEUF retractor.....	139
FARABEUF-COLLIN raspatoriesies.....	274
FARABEUF-LAMBOTTE bone holding forceps.....	243
FARRELL cotton-applicator.....	203
FARRIOR ear specula.....	400
FARRIOR ear specula.....	400
FAULKNER curette.....	449
FAURE biopsy forceps.....	588
FAURE peritoneum clamp.....	123
FAVALORO vascular scissors.....	61
FEHLAND intestinal clamp.....	542
FEILCHENFELD tissue forceps.....	91
FELDHEIM bone holding clamp.....	249
Female Urinal.....	621/2
FERGUSSON bone holding forceps.....	243
FERGUSSON clamp.....	109
FERGUSSON FRAZIER suction tube.....	337
FERGUSSON gall stone curette.....	533
FERGUSSON surgical scissors.....	66
FERRIERA retractor.....	197
FERRIS-SMITH laminectomy rongeur.....	343
FERRIS-SMITH surgical tissue forceps.....	85
FERRIS-SMITH-KERRISON rongeur.....	344, 344/2
FICHOCHIETTO-BABY rib spreader.....	482
files nail.....	612/1
FINGER nail drill.....	297
Finger ring saw REDA.....	297
Finger ring saw WALTON.....	297
Finger-Goniometer.....	25
Fingersaw LANGENBECK.....	296
FINOCCHIETTO bronchusclamp.....	490
FINOCCHIETTO rib spreader.....	482
FINOCCHIETTO Baby rib spreader.....	482
FINOCCHIETTO needle holder.....	211
FINOCCHIETTO rib spreader.....	484
FINOCCHIETTO-BURFORD rib spreader.....	483
FINSEN retractor.....	168
FINSTERER Suction tubes.....	28
FISCH dissector.....	420
FISCH fine hook.....	335
FISCHER iris tissue forceps.....	384
FISH probes.....	199
FISHER tonsil knives.....	466
fistula hook EMMETT.....	594
fistula probes PRATT.....	563
fistulaprobes LOCKHART-MUMMERY.....	200
fixation forceps BARRAQUER.....	390
fixation forceps CASTROVIEJO.....	390
fixation forceps Cottle.....	410
fixation forceps ELSCHNIG.....	389
fixation forceps GRAEFE.....	389
fixation forceps GREEN.....	390
fixation forceps LESTER.....	389
Fixierforc BURCH.....	373
Flat forceps.....	316, 317
FOERSTER dressing forceps.....	136
FOERSTER IRIS tissue forceps.....	383
FOMON nose rasp.....	444
FOMON nose scissors.....	588
FOMON raspatories.....	277
FOMON Rhinoplastscissors.....	65/1
FOMON septum chisels.....	451
FOMON skin hook.....	447/1
FOMON TC nose rasp.....	445
Forceps RESANO.....	85

foreign body chisels DIX	374
foreign body curette ALVIS	374
foreign body forceps HARTMANN	412
foreign body forceps HARTMANN-HOFFMANN	412
foreign body forceps HARTMANN-WULLSTEIN	412
foreign body forceps MATHIEU	553/1
foreign body gouges WALTON	374
foreign body instr. DIX	380
foreign body lever BUCK	412
foreign body lever QUIRE	412
foreign body needle	374
foreign body needle FRANCIS	374
foreign body needle LA FORCE	374
FOX LUPUS curette	608
FRAENKEL interchangeable tips	472
FRANCIS foreign body needle	374
FRAZIER abdominal retractor	181
FRAZIER dura dissector	333
FRAZIER punctum cannula	337
FRAZIER skin hook	148/2
FREEMAN face lift scissors	74
FREEMAN retractor	198
FREER elevator IUM	434
FREER septum chisels	439, 442
FREER septum elevator	437
FREER septum knives	434
FREER skin hook	448
FRENZEL nystagmus spectacles	20
FRENZEL tongue depressors	451
FRIEDMANN MINI bone rongeur	234
FRIEDMANN specula	577
FRITSCH retractor	163
FRYKHOLM bone rongeur	240
FUCHS capsular forceps	391
FUCHSIG hemostatic clamp	113

G

Galeahook YASARGIL	330
gall duct dilator BAKES	532
gall stone curette DESJARDINS	534
gall stone curette FERGUSSON	533
gall stone curette LUER-KOERTE	533
gall stone curette MAYO	534
gall stone forceps BLAKE	530/2
gall stone forceps DESJARDINS	530/2
gall stone forceps MAYO-BLAKE	530/2
gall stone forceps MIXTER	530/2
gall stone probes DESJARDINS	531
gall stone probes MAYO	534
gall stone probes MOYNIHAN	531
Gall Stone Probes OCHSNER	531
GALLAHER ANTRUM rasp	446
GASS hook	376
GAUSS scalp forceps	605
GELPI abdominal retractor	189/1, 189/2
GELPI hook	193
GEMINI hemostatic clamp	115
GERALD anatomic tissue forceps	86
GERALD surgical tissue forceps	87
GERSTER bone holding clamp	250
GERZOG mallet	270
GIERTZ-STILLE rib scissors	481
GIGLI saw	332
GILL corneal scarifier	373
GILL iris tissue forceps	384
GILL-ARRUGA capsular forceps	390
GILL-HESS iris tissue forceps	384
GILLIES needle holder	212
GILLIES skin hook	448
GILLIES surgical tissue forceps	86
GIL-VERNET retractor	152
GLOVER atrauma clamp	100
GLOVER bulldog clamp	103

GLOVER vascular clamp	515
GLUCK rib scissors	480
GOELET retractor	141
GOLDMANN-FOX gum scissors	67
GOMEL microsurgical tissue forceps	96
GOMMEL micro scissors	80
goniometer for finger	25
goniometer MOELTGEN	25
goniotomy knives SCHEIE	373
GOOD tonsil scissors	59
GOODELL uterine Dilatator	581
GORNEY dissector	277
GORNEY FACE LIFT scissors	73
GOSSET abdominal retractor	181
gouges	264
gouges PARTSCH	259
gouges COBB	262
gouges HIBBS	265
gouges LEXER MINI	263
gouges WEST	442/1
gouges ZIELKE	264
gouges STILLE	260
GOURDET uterine curette	599
GRADLE cilia forceps	395
GRADLE ophthalmologic scissors	57
graduated measure	620
GRAEFFE cataract curette	377
GRAEFFE cataract knives	371
GRAEFFE cystotome	375
GRAEFFE discision knives	372
GRAEFFE discision knives	372
GRAEFFE fixation forceps	389
GRAEFFE hook	148/2
GRAEFFE IRIS tissue forceps	382
GRAEFFE scissors	56
GRAEFFE strabismus hook	375
GRAEFFE tissue forceps	83
GRAFFE eye specula	370
GRAHAM nerve hook	328
grasping forceps	316
grasping forceps	415
grasping forceps LAHEY	479
grasping forceps MARTEL	110
grasping forceps PRATT	110
grasping forceps WILLET MARTEL	110
grasping tissue forceps COLLIN-DUVAL	85
grasping tissue forceps durANTE	88
grasping tissue forceps DUVAL	85
grasping tissue forceps LERCHE	83
grasping tissue forceps RUSS MODELL	85
GRAVE vaginal specula	570
GRAY hemostatic clamp	121
GREEN corneal dissector	374
GREEN fixation forceps	390
GREEN muscle hook	375
GREEN retractor	160
GREEN-ARMYTAGE	605
GREGOIRE intestinal forceps	538
GREGORY Atrauma-Bulldog Clamps	100
GREVEN micro ear forceps	414
GROSS ear curette	409
GROSS-MAIER dressing forceps	134
GRUBER ear specula	399
guide driver	321
guide needle REDON	207
GUILLEN suction raspatories	433/1
gum scissors LA GRANGE	69
gumscissors GOLDMAN-FOX	67
gumscissors LOCKLIN	69
gumscissors QUINBY	67
GUTHRIE skin hook	148/2
GUYON catheter einguide	554
GUYON dilation bougie	554
GUYON hemostatic clamp	122

GUYON kidney clamp	122
GUYTON-LUNDSGAARD sclerotome	373
GWYNNE EVANS Tonsil-Elevators	465
gynecological scissors DOYEN	63
gynecological scissors DUBOIS	63
gynecological scissors SIEBOLD	62
gynecological scissors SIMS	62
gynecological scissors WERTHEIM	63

H

HABERER intestinal spatula	143/3
haemorrhoid forceps McGIVNEY	568
haemorrhoid Ligator RUDD	568
haemorrhoidal clamp FERGUSSON	109
haemorrhoidal forceps HEYWOOD-SMITH	567
Haemorrhoidal Ligator MC GIVNEY	568
HAGLUND-STILLE plaster retractor	232
HAIGHT rib spreader	487
HAJEK mallet	273
HAJEK septum chisels	442/1
HAJEK-BALLENGER elevator	439
HAJEK-KOFLER rongeur	429, 431
HALLE bone curettes	253
HALLE septum elevator	437
halogen lamp for laryngoscope	29
HALSEY needle holder	208
HALSTED-MOSQUITO hemostatic clamp	105
handle for chisels/chisels	266
handle For chisels/OSTEO	266
handle scalpel	38, 39, 39/1, 39/2, 40, 41
handle scalpel MINI	41
HANK uterine dilator	580
HARGIS awl	463
HARGIS mandibular body retractor	463/6
HARGIS raspatory	463/2
HARKEN auricle clamp	503
HarmS lachrymal probes	381
HarmS probes	333
HARRINGTON bronchus clamp	490
HARRINGTON hook	193
HARRINGTON -PEMBERTON retractor	147
HARRINGTON retractor	147
HARTMANN ear catheter	408
HARTMANN ear specula	399
HARTMANN foreign body forceps	412
HARTMANN foreign body lever	411
HARTMANN hemostatic clamp	104
HARTMANN nose specula	422, 427
HARTMANN polyep forceps	424
HARTMANN tongue depressors	452
HARTMANN tuning forks	403
HARTMANN-HALLE nose specula	421
HARTMANN-HOFFMANN foreign body forceps	412
HARTMANN-WULLSTEIN foreign body forceps	412
HASSON retractor	143
HAUGH micro ear forceps	414
HAYES Bone Levers	284
HAYES rectum clamp	545
head holder CRUTCHFIELD	327
head light CLAR	22
head mirror ZIEGLER	21
head punch CONE	331
HEANEY hysterectomy clamp	126
HEANEY needle holder	210
HEANY biopsy curette	587
HEANY retractor	164
HEANY-BALLETINE hysterectomy clamp	127
HEATH mallet	273
HEATH suture scissors	377
HEBRA chalazio curette	66
HEGAR uterine dilator	578, 579
HEIFETZ brain spatula	369
HEIMING kidney stone forceps	536

HEISS hemostatic clamp.....	112
HEISTER mouth gags.....	454
hemostatic clamp ADSON.....	112
hemostatic clamp ADSON-BABY.....	113
hemostatic clamp BAINBRIDGE.....	120
hemostatic clamp BENGOLEA.....	112
hemostatic clamp BIRKETT.....	116
hemostatic clamp BRIDGE.....	116
hemostatic clamp COLLER-CRILE.....	106
hemostatic clamp CRAFOORD.....	118
hemostatic clamp CRAFOORD-SELLORS.....	118
hemostatic clamp CRILE.....	107
hemostatic clamp CRILE-RANKIN.....	107
hemostatic clamp DANDY.....	109
hemostatic clamp DEBAKEY-MOSQUITO.....	509
hemostatic clamp DEBAKEY-PEAN.....	513
hemostatic clamp DEBAKEY-RANKIN.....	512
hemostatic clamp DESJARDINS.....	121
hemostatic clamp FUCHSIG.....	113
hemostatic clamp GEMINI.....	115
hemostatic clamp GRAY.....	121
hemostatic clamp GUYON.....	122
hemostatic clamp HALSTED-MOSQUITO.....	105
hemostatic clamp HALSTED-MOSQUITO titanium.....	105
hemostatic clamp HARTMANN.....	104
hemostatic clamp HEISS.....	112
hemostatic clamp JACOBSON.....	105
hemostatic clamp JOHNS-HOPKINS.....	120
hemostatic clamp KANTROWITZ.....	119
hemostatic clamp KELLY.....	106
hemostatic clamp KELLY-RANKIN.....	106
hemostatic clamp KOCHER.....	108
hemostatic clamp LAHEY.....	120
hemostatic clamp LAWRENCE.....	119
hemostatic clamp LERICHE.....	111
hemostatic clamp LOVELACE.....	109
hemostatic clamp LOWER.....	120
hemostatic clamp MAYO-GUYON.....	122
hemostatic clamp MEEKER.....	119
hemostatic clamp Micro-HARTMANN.....	104
hemostatic clamp MIXTER.....	119, 121
hemostatic clamp MIXTER-BABY.....	119
hemostatic clamp MOYNIHAN.....	121
hemostatic clamp O'SHAUGNESSY.....	120
hemostatic clamp OVERHOLT.....	114
hemostatic clamp PEAN.....	108
hemostatic clamp PEAN.....	110
hemostatic clamp PENNINGTON.....	109
hemostatic clamp PROVIDENCE-HOSPITAL.....	106
hemostatic clamp ROBERTS.....	117
hemostatic clamp ROCHESTER-CarmALT.....	109
hemostatic clamp ROCHESTER-OCHSNER.....	108
hemostatic clamp ROCHESTER-PEAN.....	108
hemostatic clamp RUMEL.....	117
hemostatic clamp SAROT.....	118
hemostatic clamp S-cvd MIXTER.....	116
hemostatic clamp SPENCER-WELLS.....	109
hemostatic clamp STILLER.....	122
hemostatic clamp TOENNIS.....	117
hemostatic clamp WIKSTROEM.....	117
hemostatic clamp ZENKER.....	118
hemostatic clamp OVERHOLT-BABY.....	114
hemostatic clamp OVERHOLT-GEISSENDÖRFER.....	114
hemostatic clamp OVERHOLT-MIXTER.....	115
Hemostatic Forceps CHRISTOPHE.....	107
Hemostatic Forceps TERRIER.....	106
hemostats.....	259
HENKE tonsil-elevator.....	465
HENLEY retractors.....	170
HENNIG plaster retractor.....	232
HEPP-SCHEIDEL micro scissors.....	78
HERCULES wire cutter.....	320/1 - 320/3
HERRICK NIERENSTIELclamp.....	123
HESS capsular forceps.....	391

HESS iris tissue forceps.....	384
HEYMANN septum forceps.....	425
HEYMANN nose scissors.....	58
HEYMANN-KNIGHT ear forceps.....	425
HEYWOOD-SMITH haemorrhoidal forceps.....	567
HIBBS chisels.....	265
HIBBS gouges.....	265
HIBBS retractor.....	164
HILL-FERGUSON rectal-specula.....	560
HIRSCHMAN spatula.....	331
HIRSCHMANN anoscope.....	562
HOEN dura dissector.....	333
HOESEL needle holder.....	213
HOEFER retractor.....	465
HOHMANN bone levers.....	284, 285
HOHMANN MINI.....	286
HOKE chisels.....	265
holding arm system LEYLA.....	368 - 368/4
holding clamp ADSON.....	298
HOLSHER nerve hook.....	329
HOLZBACH hysterectomy clamp.....	126
HOLZHEIMER retractor.....	168
hook BALFOUR.....	193
hook BARBARA.....	419
hook DAY.....	409
hook FISCH.....	335
hook forceps BARRET.....	582
hook forceps BRAUN.....	582
hook forceps CZERNY.....	584
hook forceps DUPLAY.....	582
hook forceps HULKA.....	583
hook forceps IOWA.....	584
hook forceps JACOBS.....	583
hook forceps JARCHO.....	583
hook forceps MUSEUX.....	583
hook forceps PRATT.....	584
hook forceps Schröder.....	584
hook forceps SCHROEDER.....	583
hook forceps SCHROEDER (POZZI).....	582
hook forceps SKENE.....	582
hook forceps TEALE.....	583
hook forcepsSTAUDE-MOORE.....	582
hook GASS.....	376
hook GELPI.....	193
hook HARRINGTON.....	193
hook KELLY.....	193
hook KUGLEN.....	376
hook LUCAE.....	409
hook McGEE.....	419
hook SCOVILLE.....	196
hook SINSKEY.....	376
hook SMELLIE.....	605
hook WAGENER.....	409
hook STEVENS.....	375
HOPKINS plaster knives.....	233
HORIZON clip forceps.....	524
HORSLEY dura dissector.....	333
HÖSEL retractor.....	167
HOUSE curette.....	420
HOUSE suction tubeE.....	337/2
HOWARTH septum elevator.....	438
HRYNDSCHAK Bladder Retractors.....	553
HUBER UNIVERSALhandle.....	472
HUDSON bone hand drills.....	298
HUDSON T-handle.....	300
HULKA hook forceps.....	583
HUMBY DERMATOM.....	50
HUNTER splinter forceps.....	91
HURD tonsil elevator.....	465
hypophyse curette.....	334
hypophyse tissue forceps ADSON.....	334
hysterectomy clamp HEANEY.....	126
hysterectomy clamp HEANY-BALLENTINE.....	127
hysterectomy clamp MAINGOT.....	123/1, 123/2

hysterectomy clamp ROGERS.....	127
hysterectomy clamp SEGOND.....	125
hysterectomy clamp SEGON-LANDAU.....	125
hysterectomy clamp WERTHEIM.....	124
hysterectomy clamp WERTHEIM.....	128
hysterectomy forceps WERTHEIM-CULLEN.....	125
hysterectomy scissors WERTHEIM.....	63

I.U.D. extractor hook.....	593
I.U.D. SERPENTINE GRASPER.....	593
Illumination attachment for MORGAN.....	565
impactor/extractor.....	322/1
incision scissors.....	52
INGE lamina spreader.....	339
INGROWN nail instrument.....	612/1
INSTRU CARE instrument oil.....	634
instrument BOX.....	617
instrument oil INSTRU CARE.....	635
interchangeable tips BARACANI.....	472
interchangeable tips BRUENINGS.....	472
interchangeable tips CORDES.....	472
interchangeable tips FRAENKEL.....	472
interchangeable tips FRAENKEL.....	472
interchangeable tips KRAUSE.....	472
interchangeable tips LANGE.....	472
interchangeable tips SCHEINMANN.....	472
interchangeable tips SCHUMACHER.....	472
interchangeable tips SEIFERT.....	472
intervertebral disc rongeur COLCLOUGH.....	344/1
intestinal clamp BABY-KOCHER.....	540
intestinal clamp Brunner.....	543
intestinal clamp DOYEN.....	540
intestinal clamp FEHLAND.....	542
intestinal clamp KOCHER.....	540
intestinal clamp MAYO-ROBSON.....	541
intestinal clamp PAYR.....	549
intestinal clamp RESANO.....	542
intestinal clamp SCUDDER.....	541
intestinal clamp STONE-WATT.....	545
intestinal forceps GREGOIRE.....	538
intestinal grasping forceps ALLIS.....	537
intestinal grasping forceps ALLIS-ADAIR.....	537
intestinal grasping forceps ALLIS-BABY.....	537
intestinal grasping forceps ATRAUMA.....	111
intestinal grasping forceps BABCOCK.....	539
intestinal grasping forceps COLLIN.....	539
intestinal grasping forceps DOYEN-BABY.....	540
intestinal grasping forceps DUVAL.....	539
intestinal grasping forceps JUDD-ALLIS.....	538
intestinal grasping forceps LITTLEWOOD.....	538
intestinal grasping forceps LOCKWOOD-ALLIS.....	538
intestinal grasping forceps THOMS-ALLIS.....	538
intestinal grasping forceps WILLIAMS.....	539
intestinal spatula HABERER.....	143/3
intestinal spatula LERICHE.....	143/4
intestinal spatula REVERDIN.....	143/3
intestinal spatula RIBBON.....	143/1
intima spatula.....	530/1
intra oral retractors.....	463/1
intraduillary drills.....	322
IOWA hook forceps.....	584
IOWA needle guide.....	206
Iris hook O'CONNOR.....	375
Iris hook WIENER.....	375
iris knives DEAN.....	372
iris knives ZIEGLER.....	372
IRIS scissors.....	542
Iris scissors KNAPP.....	55
Iris scissors LITTLER.....	55
Iris spatula WECKER.....	378
IRIS supercut scissors.....	72
iris tissue forceps BARRAQUER-KATZIN.....	384

iris tissue forceps BISHOP-HARMAN.....	386
iris tissue forceps BONN.....	387
iris tissue forceps FISCHER.....	384
iris tissue forceps FOERSTER.....	383
iris tissue forceps GILL.....	384
iris tissue forceps GILL-HESS.....	384
Iris tissue forceps GRAEFE.....	382
iris tissue forceps HESS.....	384
iris tissue forceps KIRBY-ARTHUR.....	385
iris tissue forceps ModELL BONN.....	387
iris tissue forceps TROUTMAN.....	384, 389
iris tissue forceps type TUEBINGEN.....	387
iris tissue forceps STEVENS.....	383
irrigation cannula EICKEN (KILLIAN).....	433
irrigation cannula KILLIAN.....	433/1
irrigation cannula KILLIAN.....	433/1
irrigation cannula RITTER-HALLE.....	433
irrigation cannula SIMCOE.....	394/2
Irrigations cannula type LACRIMAL.....	394
ISRAEL retractor.....	162
ITERSON trachea hook.....	477
IVES-FANSLER anoscope.....	562
IWANSON Measuring instrument.....	227

J

JACKSON tendon grasping forceps.....	292
JACKSON trachea hook.....	476
JACKSON vaginal specula.....	573
JACKSON-BURROWS retractor.....	189/2
JACOBS hook forceps.....	583
JACOBSON buttonprobes.....	335
JACOBSON curette.....	257
JACOBSON dura hook.....	335
JACOBSON hemostatic clamp.....	105
JACOBSON needle holder.....	215
JAEGER discision knife.....	372
JAEGER lid plate.....	371
JAMESON strabismus forceps.....	385
JAMESON strabismus hook.....	375
JANSEN bone curettes.....	257
JANSEN bone rongeur.....	237
JANSEN ear forceps.....	424
JANSEN retractor.....	168
Jar.....	620
JARCHO hook forceps.....	583
JAVID carotid shunt clamp.....	511
JENNINGS mouth gags.....	454
jewelry tissue forceps.....	90
JOBSON-hornyE cotton-applicator.....	203
JOHNS-HOPKINS applier forceps.....	104
JOHNS-HOPKINS bulldog clamp.....	104
JOHNS-HOPKINS hemostatic.....	120
JONES towel clamp.....	132
JONES-clip towel clamp.....	132
JORGENSEN dissecting scissors.....	53
JOSEPH (LEWIS) nose rasp.....	443
JOSEPH nose rasp.....	443
JOSEPH nose saw.....	446
JOSEPH raspatories.....	277
JOSEPH septum.....	437
JOSEPH septum knives.....	434
JOSEPH septum knives.....	434, 435
JOSEPH skin hook.....	149
JOSEPH surgical scissors.....	54/1
JUDD-ALLIS intestinal grasping forceps.....	538
JUDD-MASSON bladder retractors.....	552
JUERS micro ear forceps.....	414
JURASZ laryngeal polypus forceps.....	471

K

KADER abdominal spatula.....	143/1
KALLMORGEN specula.....	573

KALT capsular forceps.....	391
KALT needle holder.....	214
KALT needle holder.....	214
KALT-ARRUGA needle holder.....	214
KANE navelstringclamp.....	605
KANTROWITZ hemostaticL.....	119
KAYE FACE LIFT scissors.....	73
KEINSASSER OP-laryngoscope.....	35
KEITH needle.....	223
KELLY GRIP retractor.....	142
KELLY hemostatic clamp.....	106
KELLY hook.....	193
KELLY proctoscope.....	562, 563
KELLY retractor.....	164
KELLY uterine polyp forceps.....	585
KELLY vascular scissors.....	61
KELLY-RANKIN hemostatic clamp.....	106
Keratoplast-knives BARRAQUER.....	373
Keratoplast-knives PAUFIQUE.....	373
KERN bone holding forceps.....	244
KERRISON rongeur.....	428
KEVORKIAN biopsy curette.....	587
KEVORKIAN biopsy forceps.....	589, 591
KEVORKIAN-PACIFIC biopsy forceps.....	592
KEY elevator.....	282
KEYES punch.....	608
kidney clamp GUYON.....	122
kidney forceps HERRICK.....	123
kidney stone forceps HEIMING.....	536
kidney stoneforceps RANDALL.....	535
kidney tray.....	619
KIELLAND obstetrical forceps.....	602
KIELLAND-LUIKART obstetrical forceps.....	603
KILLIAN gouges.....	442/1
KILLIAN nose specula.....	423
KILLIAN septum elevator.....	438, 439
KILLIAN septum scissors.....	471
KILLIAN-CLAUS septum gouges.....	442/1
KILNER needle holder.....	212
KILNER nose hook.....	447/1
KILNER skin hook.....	608
KILNER surgical scissors.....	54/1
KILNER/RAGNELL supercut scissors.....	72
KILNER-DOUGHTY mouth gag.....	456
KIRBY-ARTHUR IRIS forceps.....	385
KIRK mallet.....	270
KIRSCHNER.....	312
KIRSCHNER abdominal retractor.....	187, 187/1
KIRSCHNER drill wire.....	306, 307
KIRSCHNER guideprobes.....	221
KIRSCHNER nail.....	308, 309
KIRSCHNER US extension bow.....	312
KLAPP retractor.....	150
KLEINERT-KUTZ rongeur.....	237
KLEINERT-KUTZ skin hook.....	149
KLEINERT-KUTZ tendon grasping instrument.....	294
KLEINSASSER chest support.....	36
KLEINSASSER injection cannula.....	36
KLEINSASSER light guide.....	36
KLEINSASSER suction tube tube.....	36
KLINKENBERGH-LOTH vascular scissors.....	65/1
KNAPP cataract curette.....	378
KNAPP extraction hook.....	375
KNAPP IRIS scissors.....	55
KNAPP-LUER forceps.....	393
KNIGHT septum forceps.....	425
knives amputation.....	44
knives BALLENGER.....	436
knives bone.....	44
knives LANGENBECK.....	47
knives MUCK.....	420
knives PLESTER.....	418
knives ROSEN.....	418
knives SCHUKNECHT.....	418

knives TABB.....	418
knives WULLSTEIN.....	418
KNOWLES bandage scissors.....	70
KOCHER bladder spatula.....	552
KOCHER hemostatic clamp.....	108
KOCHER intestinal clamp.....	540
KOCHER probes.....	479
KOCHER retractor.....	155, 160, 163
KOCHER-LANGENBECK retractor.....	159
KOENIG needle.....	223
KOERTE abdominal spatula.....	143/3
KOERTE retractor.....	162
KOGAN endo specula.....	577
KÖNIG bone levers.....	284
KÖNIG guideprobes.....	221/1
KÖNIG raspatories.....	276
KÖNIG retractor.....	153
KOOS dura knives.....	335
KRAUSE interchangeable tips.....	472
KRAUSE polyp snare.....	433/2
KRAUSE polyp snare.....	411, 434
KRAUSE-VOSS polyp snare.....	433/2
KRAYENBÜHL nerve hook.....	336
KRISTELLER specula.....	572
KRISTELLER vaginal specula.....	572
KROENIG tongue depressors.....	451
KRONECKER ligaturee needle.....	219
KUGLEN hook.....	376
KÜMMEL abdominal spatula.....	143/4, 144
KÜNTSCHER driver.....	321
KÜNTSCHER extractor.....	322
KÜNTSCHER reamer.....	321
K-wire dispenser.....	310

L

LA FORCE adenoid curette.....	450
LA FORCE foreign body needle.....	374
LA GRANGE gum scissors.....	69
LABORDE trachea dilator.....	476
lachrymal dilat. WILDER.....	381
lachrymal dilat.CASTROVIEJO.....	381
lachrymal probes BOWMAN.....	381
lachrymal probes HarmS.....	381
LACRIMAL Irrigationscannula.....	394
LAHEY grasping forceps.....	479
LAHEY hemostatic clamp.....	120
LAHEY retractor.....	149, 157
LAMBERT chalazio tissue forceps.....	393
LAMBERT-KAY aortic-ANASTOMOSIS clamp.....	505
LAMBERT-LOWMAN bone holding clamp.....	249
LAMBOTTE bone holding forceps.....	244
LAMBOTTE Bone Levers.....	287
LAMBOTTE chisels.....	261
LAMBOTTE raspatories.....	274, 275
lamina spreader CLOWARD.....	339
lamina spreader INGE.....	339
laminectomy retractor CHERRY.....	488
laminectomy rongeurs CLOWARD.....	342
laminectomy rongeurs OLDBERG.....	341/1
laminectomy rongeurs SCHLESINGER.....	342
laminectomy rongeurs SPURLING.....	340
laminectomy rongeurs WAGNER.....	343
laminectomy rongeurs CUSHING.....	340
laminectomy rongeurs FERRIS-SMITH.....	343
laminectomy rongeurs LOVE-GRUENWALD.....	340
laminectomy retractor SCOVILLE.....	196
laminectomy retractor SCOVILLE-HAVERFIELD.....	196
LANCASTER eye specula.....	371
lancet electrode MONOPOLAR.....	628, 629
LANDAU vaginal specula.....	577
LANE bender.....	325
LANE bone holding forceps.....	244
LANE bone levers.....	290

Lane bone levers..... 290
 LANE bone plate holding forceps..... 325
 LANE screw driver..... 323, 324
 LANE srewholding forceps..... 325
 LANE stomach clamp..... 548
 LANE surgical tissue forceps..... 84
 LANE towel clamp..... 133
 LANE TRETOWAN bone levers..... 290
 LANG extraction dissector..... 378
 LANGE interchangeable tips..... 472
 LANGE nose hook..... 448
 LANGE-HOHMANN..... 286
 LANGENBECK..... 409
 LANGENBECK amputation knives..... 44
 LANGENBECK bone holding forceps..... 243
 Langenbeck ear loop..... 409
 LANGENBECK-FINGER saw..... 296
 LANGENBECK knives..... 47
 LANGENBECK needle holder..... 213
 LANGENBECK raspatories..... 275
 LANGENBECK retractor..... 158, 159
 LANGENBECK-GREEN retractor..... 153
 LANGENBECK-MANNERFELT Retractor
 with treangle handle..... 148/4
 LARSEN tendon grasping forceps..... 292
 laryngeal cannula..... 470
 laryngeal mirror..... 473
 laryngeal mirror MICHEL..... 423
 laryngeal polypus forceps FRAENKEL..... 471
 laryngeal polypus forceps JURASZ..... 471
 laryngoscope FOREGGER..... 29, 31
 laryngoscope handle cold light..... 33
 laryngoscope handle warm light..... 32
 Laryngoscope handles..... 31-34/2
 laryngoscope MCINTOSH..... 29/1, 30/1
 laryngoscope MILLER..... 29/3, 30/3
 Lateral vaginal retractor..... 569
 LAWRENCE hemostatic clamp..... 119
 lead hand..... 250
 LEBSCHKE skull breaker..... 267
 LEES bronchus clamp..... 504
 LEGUEU bladder spatula..... 552
 LEKSELL(STILLE) bone rongeur..... 240
 LELAND-JONES vascular clamp..... 495
 LEMPET bone currettes..... 256
 LEMPET bone rongeur..... 237
 LERCHE grasping tissue forceps..... 83
 LERICHE abdominal spatula..... 143/4
 LERICHE hemostatic clamp..... 111
 LESTER fixation forceps..... 389
 LEWIN bone holding forceps..... 246
 LEWY Chest Support..... 37
 LEXER BABY dissecting scissors..... 53
 LEXER chisels..... 263
 LEXER dissecting scissors..... 53
 LEXER MINI gouges..... 263
 LEYLA holding arm system..... 368 - 368/4
 LICHTWITZ trocar..... 204
 ligature rings..... 568
 ligature scissors..... 54
 ligaturee needle..... 218
 ligaturee needle COOPER..... 219
 ligaturee needle DESCHAMPS..... 218
 ligaturee needle KRONECKER..... 219
 ligaturee needle SCHMIEDEN-DICK..... 219
 lip retractor..... 453
 LISTER bandage scissors..... 69/1
 LISTER SUPERCUT scissors..... 72
 LISTER(SINUS) dressing forceps..... 137
 LISTON amputation knives..... 44
 LISTON bone cutting forceps..... 241
 LITTAUER cilia forceps..... 395
 LITTAUER ear forceps..... 411
 LITTAUER polyp forceps..... 425

LITTAUER suture scissors..... 66
 LITTLE retractor..... 157
 LITTLER IRIS scissors..... 55
 LITTLEWOOD intestinal grasping forceps..... 538
 LOCKHART-MUMMERY fistula probes..... 200
 LOCKLIN gum scissors..... 69
 LOCKWOOD-ALLIS intestinal grasping forceps..... 538
 LONDON-COLLEGE teeth tissue forceps..... 93
 loop electrode MONOPOLAR..... 628, 629
 LOPEZ-REINKE tonsil..... 465
 LORENZ bandage scissors..... 70
 LORNA towel clamp..... 133
 LOUVE wire instrument..... 315
 LOVE nerve hook..... 329, 330
 LOVE retractor..... 465
 LOVE-GRUENWALD..... 340
 LOVELACE hemostatic clamp..... 109
 LOVELACE lung grasping forceps..... 490
 LOWER hemostatic clamp..... 120
 LOWMAN bone holding clamp..... 249
 LOWMAN-HOGLUND bone holding clamp..... 249
 LUBET-BARBON nose dressing forceps..... 424
 LUC septum forceps..... 426
 LUCAE ear forceps..... 410
 LUCAE hook..... 409
 LUCAE mallet..... 271
 LUCAE paracentesis needle..... 408
 LUCAE tuning forc..... 404
 LUCAS..... 260
 LUER bone rongeur..... 236
 LUER retractor..... 140
 LUER trachea cannula..... 479
 LUER-KOERTE gall stone curette..... 533
 LUIKART obstetrical forceps..... 603
 LUNDGAARD SKLEROTOM..... 373
 lung grasping forceps LOVELACE..... 490
 lung scissors CRAFOORD..... 65/2
 lung spatula ALLISON..... 489/2
 LUNIATSCHEK..... 465
 Lupus curette FOX..... 608
 Lupus curette PIFFARD..... 608

M

MAGAUAN adenoidectomy - tonsillectomy..... 459
 MAGILL CATETHER INTRODUCING FORCEPS..... 28
 MAIER dressing forceps..... 134
 MAINGOT hysterectomy forceps..... 123/1, 123/2
 Male Urinal..... 621/2
 mallet..... 270, 272
 mallet BERGMANN..... 272
 mallet COLLIN..... 270
 mallet COTTLE..... 273
 mallet GERZOG..... 270
 mallet HAJEK..... 273
 mallet HEATH..... 273
 mallet KIRK..... 270
 mallet LUCAE..... 271
 mallet MEAD..... 271
 mallet OMBREDANNE..... 273
 mallet PARTSCH..... 271
 mallet QUISLING..... 271
 mallet WILLIGER..... 271
 Mallets DOYEN..... 271
 Mallets (COTTLE) nose rasp..... 444
 MALTZ nose rasp..... 443
 Mammaria spreader..... 487/1
 mandibular body retractor HARGIS..... 463/6
 MANDRIN for tourniquet..... 528
 MANNERFELT Retractor
 with treangle handle..... 148/3, 148/4, 148/5
 MANOMETER..... 295, 596
 MARQUARD bone rongeur..... 239
 MARSCHIK tonsil forceps..... 468

MARTEL grasping forceps..... 110
 MARTIN bone holding forceps..... 246
 MARTIN CARTILAGE scissors..... 65/1
 MARTIN pelvimeter..... 605
 MARTIN retractor..... 175/1
 MARTIN uterine-probes..... 586
 MARTINI bone currettes..... 257
 MASING septum elevator..... 437
 MASSING-NEIVERT nose hook..... 447/1
 MASSON needle holder..... 210
 MASTIN muscle clamp..... 479
 MATHIEU foreign body forceps..... 553/1
 MATHIEU needle holder..... 213
 MATHIEU rectal-specula..... 560
 MATHIEU retractor..... 141
 MATHIEU-OLSEN needle holder..... 212
 MATSON raspatories..... 279
 MATSON-ALEXANDER raspatories..... 279
 MAXI GRASPER biopsy forceps..... 593
 MAYFIELD bone rongeur..... 238
 MAYO dissecting scissors..... 52
 MAYO gall stone curette..... 534
 MAYO gall stone probes..... 534
 MAYO sterilization clamp..... 227
 MAYO supercut scissors..... 71
 MAYO tissue forceps..... 89
 MAYO tongue depressors..... 451
 MAYO-ADAMS retractors..... 171
 MAYO-BLAKE gall stone forceps..... 530/2
 MAYO-COLLINS retractor..... 141
 MAYO-HABERISSER wire forceps..... 319
 MAYO-HEGAR needle holder..... 209
 MAYON-GUYON hemostatic clamp..... 122
 MAYO-NOBLE dissecting scissors..... 52
 MAY-OPHTALMOSKOP UNI..... 14
 MAYO-ROBSON intestinal clamp..... 541
 MAYO-STILLE dissecting scissors..... 52
 MAYO-STILLE supercut scissors..... 71
 MC DONALD elevator..... 283
 MC GIVNEY haemorrhoidal LIGATOR..... 568
 MC INDOE bone cutting forceps..... 241
 MC KENZIE drill..... 299
 MCCULLOUGH strabismus forceps..... 385
 MCGEE hook..... 419
 MCGEE micro ear forceps..... 414
 MCINDOE scissors..... 65/1
 MCINDOE tissue forceps..... 80
 McINTOSH Laryngoskope..... 29/1, 30/1
 McIntosh Laryngoskope Sets..... 29-30
 MCINTYRE eye cannula..... 394
 MCIVOR mouth gags..... 457
 MCKENTY septum elevator..... 437, 438
 MCKENZIE applier forceps..... 326
 McKESSON Metal frame..... 454/1
 MCLEAN obstetrical forceps..... 603/1
 MCLEAN-LUIKART obstetrical forceps..... 603/1
 MCPHERSON tissue forceps..... 392
 MEAD bone rongeur..... 235
 MEAD mallet..... 271
 Measuranc circle CASTROVIEJO..... 380
 Measuring instrument IWANSON..... 227
 medicine cup..... 621
 medicine spoon..... 621
 MEEKER hemostatic clamp..... 119
 MEHDORN applier forceps..... 362
 MEHDORN vascular clip..... 362
 MELLINGER eye specula..... 370
 MENGHINI biopsy needle..... 206
 meniscus hook BLOUNT..... 289
 meniscus knives NEFF..... 292
 meniscus knives SMILLIE..... 292
 MERIAM teeth tissue forceps..... 93
 METAL catheter..... 555
 Metal catheter COXETER..... 555

Metall frame McKESSON.....	454/1	MONOPOLAR electrode needle	628, 629	needle holder CRILE-MURRAY	209	
METZENBAUM „S“ surgical scissors	54	MOORFIELD tissue forceps.....	392	needle holder CRILE-WOOD TC	209	
METZENBAUM Dissecting Scissors	53/1, 53/3, 53/4	MORGAN Proctoscopes	565	needle holder DE BAKY	210	
METZENBAUM FINO TC dissecting scissors.....	53/1	MORITZ-SCHMIDT tongue depressors	452	needle holder DERF	208	
METZENBAUM needle holder	211	MORRIS retractor.....	164	needle holder FINOCCHIETTO	211	
METZENBAUM supercut scissors	71	MORRIS-DEBAKEY aortic clamp	506	needle holder GILLIES	212	
METZENBAUM TC dissecting scissors	53/1	MORSE rib spreader.....	484	needle holder HALSEY	208	
MEYER bone holding forceps	248	MORSE-FAVALORO rib spreader	484	needle holder HALSEY	208	
MEYERDING retractor	157	mouth gags DAVIS-BOYLE	455	needle holder HEANEY	210	
MEYERDING retractors	180	mouth gags DENHART	454	needle holder HOESEL	213	
MEYHOEFER chalazio curette	377	mouth gags DINGMANN	456	needle holder JACOBSON.....	215	
MICHEL clip forceps.....	224	mouth gags HEISTER	454	needle holder KALT-ARRUGA.....	214	
MICHEL clip tissue forceps	224	mouth gags JENNINGS	454	needle holder KILNER.....	212	
MICHEL laryngeal mirror	423	mouth gags McIVOR.....	457	needle holder LANGENBECK	213	
micro ear forceps.....	413	mouth gags ROSER-KOENIG.....	454	needle holder MASSON	210	
micro ear forceps COS	414	mouth gags DOYEN-JANSEN(MOLT).....	454	needle holder MATHIEU	213	
micro ear forceps DIETER	414	MOYNIHAN gall stone probes	531	needle holder MATHIEU-OLSEN	212	
micro ear forceps GREVEN	414	MOYNIHAN hemostatic clamp	121	needle holder MAYO-HEGAR	209	
micro ear forceps HAUGH	414	MUCK knives.....	420	needle holder METZENBAUM	211	
micro ear forceps JUERS	414	MUELLER eye specula	371	needle holder MICROVASCULAR.....	210	
micro ear forceps McGEE	414	MÜLLER APPROXIMATOR	363	needle holder NEIVERT.....	208	
micro ear scissors BELLUCCI.....	413	MÜLLER vascular clip	365	needle holder OLSEN-HEGAR	210	
micro ear scissors SHEA	413	MÜNCHEN biopsy curette.....	587	needle holder RYDER	212	
MICRO FRIEDMANN	234	MURDOCK eye specula	370	needle holder SAROT	211	
MICRO FRIEDMANN bone rongeur	234	MURPHY-LANE elevator	283	needle holder STEVENS	214	
micro scissors.....	76,77, 78, 80	muscle clamp MASTIN	479	needle holder STRATTE	212	
micro scissors BELLUCCI.....	417	muscle forceps PRINCE.....	387	needle holder WEBSTER.....	208	
micro scissors GOMEL	80	musclehook	267	needle nose plier	320	
micro scissors HEPP-SCHIEDEL	78	musclehook GREEN	375	needle REVERDIN	220	
micro scissors REDA	77, 78, 80	muscle forceps BERKE	389	needle ROSEN	419	
micro sickle knives	475	MUSEUX hook forceps	583	needle sterilization case	615	
micro tissue forceps	94	MYLES nose forceps.....	427	needles	222, 223	
micro-curette forceps WULLSTEIN	416	myoma screw DOYEN	594	NEFF meniscus knives	292	
micro-grasping forceps tube shaft	415			Negus CHEST SUPPORT	459	
MICRO-HARTMANN hemostatic clamp	104	N			NEIVERT needle holder	208
microsurgical tissue forceps GOMEL	96	NABATOFF varicose vein probes	201	NEIVERT-ANDERSON chisel	442	
MICROVASCULAR needle holder	210	NAEGELE obstetrical forceps	603	NELATON probes	199	
MIDDELDORPF retractor.....	160	NAGER retractor	465	NELSON STANDARD trocar.....	204	
MIDDLETON-JANSEN septum forceps	430	NAGER tonsil needle	466	NELSON trocar	205	
MIKULICZ intestinal clamp.....	543	nail brushes.....	611	NELSON vascular tissue forceps	89	
MIKULICZ peritoneum clamp	123	nail drill	297	NEONATAL vascular clamp	523	
MIKULICZ retractor	163	nail forceps	609, 613	Neonatal vascular clamp CASTANEDA	527	
MIKULICZ-BABY peritoneum clamp	123	nail forceps Anvil	613	nerve hook CRILE	328	
MILLER Laryngoscope	29/3, 30/3	nail forceps Radolf.....	297	nerve hook CUSHING.....	328	
MILLER Laryngoskope Sets.....	29/2, 30/2	nail forceps TURNBULL	609	nerve hook DANDY	328	
MILLER nose rasp	444	nail impactor	322/1	nerve hook GRAHAM.....	328	
MILLIGAN dura dissector	332	nail nippers	612/2, 613, 614	nerve hook HOLSHER	329	
MILLIN bladder retractors.....	552	nail rasp	610	nerve hook KRAYENBUHEL	336	
MILLIN bladder spreader.....	553	nail scissors.....	609	nerve hook LOVE	329	
MILLIN capsular grasping forceps	551	nail SET	609	nerve hook LOVE	330	
MILLIN prostatic grasping forceps	551	nail skin forceps.....	613	nerve hook SACHS	328	
Mini bulldog clamp DEBAKEY-DIETRICH	101	nail skin forceps.....	610, 613	nerve hook SCOVILLE.....	329, 330	
Mini quick handle.....	301	Nail splitting scissors.....	614	nerve hook SMITHWICK.....	328	
mini scalpel.....	41	Nasal Cutting Forceps CRAIG	426	NEUGS tonsil forceps	467	
mini scalpel handle	41	needle BARBARA	419	neurosurgical SCISSOR STRULLY	65	
Mini-bulldog clamp	101	needle electrode MONOPOLAR	628, 629	neurosurgical scissors	65	
MINI-LAMBOTTE chisels	262	needle guide IOWA	206	NEWS trachea hook	477	
MINIMUS Sphygmomanometer	12	needle holder ADSON	211	nippers nail	612/2, 613, 614	
MINI-TOWNSEND-DOWN biopsy forceps	591	needle holder ARRUGA	214	Nissen fine hemostatic clamp	113	
MINI-TOWNSEND-UP biopsy forceps	591	needle holder BABY-OLSEN-HEG	212	NISSEN hemostatic clamp	113	
MIXTER gall stone forceps	530/2	needle holder BABY-WEBSTER	208	nmnopolar forceps	634	
MIXTER hemostatic clamp	116, 119, 120, 121	needle holder BARRAQUER Micro	217	NORFOLK-NORWICH retractors	172	
MIXTER hemostatic clamp S-cvd	116	needle holder BARRAQUER Micro	217	NORTHBENT suture scissors.....	66	
MIXTER-BABY hemostatic clamp	119	needle holder BAUMGARTNER	216	nose dressing forceps LUBET-BARBON	424	
MIXTER-O'SHAUGNESSY	120	needle holder BOYNTON	214	nose dressing forceps WESTMACOTT	424	
MIXTER-O'SHAUGNESSY hemostatic clamp	120	needle holder BOZEMANN	211	nose forceps CAPLAN	428	
MODELL BONN iris tissue forceps	387	needle holder BROWN	209	nose forceps HARTMANN	427	
MOELTGEN goniometer	25	needle holder BROWN	211	nose forceps MYLES	427	
MOGEN circumcision instrument	556	needle holder CASTROVIEJO	215	nose forceps SCHMEDEN	427	
MOLLISON retractors	171	needle holder Castroviejo	216	nose forceps STRUYCKEN.....	427	
MOLT raspatoriesIUM	276	needle holder CASTROVIEJO Micro	215	nose forceps TAKAHASHI	427	
MONOPOLAR electrode ball	628, 629	needle holder cheekSTEEN	210	nose forceps WATSON-WILLIAMS.....	428	
MONOPOLAR electrode lancet	628, 629	needle holder COLLIER	208	nose forceps WEIL-BLAKESLEY	426	
MONOPOLAR electrode loop	628, 629	needle holder CRILE	213	nose hook.....	447	

nose hook AUFRICHT	447
nose hook CONVERSE	448
nose hook COTTLE	447, 447/1
nose hook LANGE	448
nose hook MASING-NEIVERT	447
nose rasp FOMON	444, 445
nose rasp JOSEPH	443
nose rasp JOSEPH (LEWIS)	443
nose rasp MALTZ	443
nose rasp MALTZ (COTTLE)	444
nose rasp MILLER	444
nose rasp PEET	446
nose rasp WIENER	443
nose saw JOSEPH	446
nose scissors	429
nose scissors COTTLE	59
nose scissors FOMON	58
nose scissors HEYMANN	58
nose specula COTTLE	423
nose specula HARTMANN	422
nose specula HARTMANN-HALLE	421
nose specula KILLIAN	423
nose specula REDA	423
nose specula THUDICHUM	421
nose specula TIECK-HALLE	423
nose specula type VIENNA	421
nose specula VOLTOLINI	421
NOTO uterine polyp forceps	585
NOVAK biopsy curette	587
NOYES eye scissors	75
NOYES polyp forceps	425
nystagmus spectacles FRENZEL	20

O

obstetrical curette SELLHEIM	607
obstetrical forceps DE LEE	602
obstetrical forceps ELLIOT	603
obstetrical forceps KIELLAND	602
obstetrical forceps KIELLAND-LUIKART	603
obstetrical forceps LUIKART	603
obstetrical forceps McLEAN	603/1
obstetrical forceps McLEAN-LUIKART	603/1
obstetrical forceps NAEGELE	603
obstetrical forceps PIPER	604
obstetrical forceps SIMPSON	602
obstetrical forceps SIMPSON-BRAUN	602
obstetrical forceps SIMPSON-LUIKART	603
obstetrical forceps THIERRY	603
obstetrical forceps WRIGLEY	602
OBWEGESER awl	463
OBWEGESER blade osteotome	464/1
OBWEGESER raspatories	462
OBWEGESER retractor	460, 461/1
OBWEGESER retractors	463
OCHSNER Gall Stone Probes	531
OCHSNER trocar	205
O'CONNOR iris hook	375
OEHLER surgical tissue forceps	81/1
OLDBERG laminectomy retractor forceps	341/1
OLIVECRONA bone rongeur	237
OLIVECRONA brain spatula	336
OLIVECRONA dura dissector	332
OLIVECRONA wire saw	332
OLIVECRONA-TOENNIS applicator forceps	326
OLLIER retractor	162
OLSEN-HEGAR needle holder	212
OMBREDANNE (JACKSON) Towel Forceps	133
OMBREDANNE Awl	304
OMBREDANNE mallet	273
Ophthalmoskop MAY UNI II	14
OP-laryngoscope KLEINSASSER	35
ophthalmologic scissors	57, 58
ophthalmologic scissors GRADLE	57

ophthalmologic scissors STEVENS	58
Oscillation plaster cast saw	
and accessories	230/10 - 230/18
osteotome blade OBWEGESER	464/1
osteotome EPKER	464/2
OSTROEM Antrum-punch	430
O'Sullivan-O'Connor abdominal retractor	181
O'SULLIVAN-O'CONNOR abdominal retractor	576
O'SULLIVAN-O'CONNOR abdominal retractors	181
OTIS Dilating Bougies	554
OTIS urethrotome	553
OVAL RING	194
OVERHOLT hemostatic clamp	114
OVERHOLT-BABY hemostatic clamp	114
OVERHOLT-GEISENDOERFER hemostatic clamp	114
OVERHOLT-MIXTER hemostatic clamp	115
ovum curette CUZZI	606
ovum curette PESTALOZZA	606
ovum curette WALLICH	607
ovum forceps SAENGER	606
ovum forceps WINTER	606

P

pan bed	621/1
pan placenta	621/1
paracentesis needle LUCAE	408
paracentesis needle POLITZER	408
parametrium clamp REDA	128/1
PARAMETRIUM scissors	63
PARK eye specula	371
PARKER retractor	139
PARTSCH chisels	259
PARTSCH mallet	271
PASSOW	260
Passow chisels	260
PATELLA forceps	248
PATON corneal dissector	373
PAUFIQUE Keratoplast.-knives	373
PAUFIQUE tissue forceps	392
PAYR guide probes	221/1
PAYR intestinal clamp	549
PEAN hemostatic clamp	108
PEAN hemostatic clamp	110
PEAN hemostatic clamp	108, 110
PEAPOD rongeur	341/1
PECK-JOSEPH dissecting scissors	74
PEDERSON vaginal specula	570
PEENFIELD dissector	333
PEERS towel clamp	132
PEET nose rasp	446
PEET splinter forceps	92
PELMKMAN dressing forceps	137
pelvimeter COLLIER	605
pelvimeter MARTIN	605
Pelvis-hook SLMARKS	165
Penisclamp Stockmann	553/1
Penisclamp STRAUSS	553/1
PENNINGTON hemostatic clamp	109
PENNINGTON septum elevator	438
percussion mallet BABINSKY	24
percussion mallet BERLINER	24
percussion mallet BUCK	24
percussion mallet TAYLOR	24
percussion mallet TROEMNER	24
PERCY RETRAKTOR	296
perforators SMELLIE	607
Peripheral vascular clamp DE BAKERY	494
Peripheral vascular clamp LELAND-JONES	495
peritoneum clamp FAURE	123
peritoneum clamp MIKULICZ	123
peritoneum clamp MIKULICZ-BABY	123
peritoneum clamp PHANEUF	123
PERKINS retractors	168

PERTHES awl	304
PESTALOZZA ovum curette	606
petri box	620
PHALANGEN knives	44
PHANEUF peritoneum clamp	123
PIERCE septum	438
PIERCE trocar	204
PIFFARD LUPUS curette	608
PILLING clip forceps	524
pin cutter	320
PINARD stethoscope	23
PINWHEEL WARTENBERG	25
PIPER obstetrical forceps	604
Pistol for cleaning	626
pituitary rongeur	341
placenta pan	621/1
plaster cast saw ENGEL	229
plaster cast saw oscillating	
and accessories	230/10 - 230/18
plaster forceps WOLFF	233
plaster knives ESMARCH	233
plaster knives HOPKINS	233
plaster knives REINER	233
plaster knives WIGMORE	229
plaster retractor BEESON	232
plaster retractor HAGLUND-STILLE	232
plaster retractor HENNIG	232
plaster retractor REDA	232
plasterscissorsSTILLE	229
platte JAEGER	371
PLESTER knives	418
PLESTER retractors	171
PLESTER suction tube	338
pneumatic tourniquet	295
POLITZER ear knives	408
POLITZER ear specula	399
POLITZER paracentesis needle	408
polyp forceps HARTMANN	424
polyp forceps LITTAUER	425
polyp forceps NOYES	425
polyp loop	411
polyp snare KRAUSE	433/2
polyp snare KRAUSE	411, 434
polyp snare KRAUSE-VOSS	433/2
polyp snare WILDE	433/2
polyp snare WILDE	411, 434
POOLE suction tube	27
POST MORTEM	268
POST MORTEM knives	48
POST MORTEM knives VIRCHOW	48
post mortem set	269
POTTS SMITH tissue forceps	81
POTTS-DE MARTEL vascular scissors	59
POTTS-SMITH tissue forceps	81
POTTS-SMITH vascular scissors	61
POZZI-PALMER tenaculum forceps	582
PRATT fistula probes	563
PRATT grasping forceps	110
PRATT hook forceps	584
PRATT rectal-specula	559
PRATT uterine Dilatator	580
PRICE-THOMAS bronchus clamp	490
PRINCE muscle forceps	387
PRINCE tonsil scissors	61
PROBE AND PACKER	59
probe tips	201
probes	199
probes BRODIE	199
probes DOYEN	199
probes FISH	199
probes Harms	333
probes JACOBSON	335
probes KOCHER	479
probes NELATON	199

probes Valleix	586
probes WATSON-CHEYNE	199
probes Worst	333
proctoscope Bensaude	565
proctoscope CHELSEA-EATON	563
proctoscope FANSLER	564
proctoscope KELLY	562, 563
Proctoscopes MORGAN	565
prostatic grasping forceps MILLIN	551
prostatic hook YOUNG	550
PROVIDENCE-HOSPITAL hemostatic clamp	106
punch KEYES	608
punction cannula FRAZIER	337
punction cannula QUINKE	206
PUTTI bone rasp	294
Pylorusretractor BENSON	544

Q

QUERVAIN elevator	275
quick handle	301
QUINBY gum scissors	67
QUINKE punction cannula	206
QUIRE foreign body lever	412
QUISLING mallet	271

R

RACHIOTOM	267
RADOLF nail forceps	297
RALK bone hand drills	299
RAMPLEY dressing forceps	136
RAMUS retractor	461
RANDALL biopsy curette	587
RANDALL kidney stone forceps	535
RANEY appling forceps	327
RANGELL retractor	140
raspatories	279
raspatories ADSON	282
raspatories ALEXANDER	276
raspatories COBB	280
raspatories DINGMANN	463, 463/3
raspatories DOYEN	278
raspatories FARABEUF	274
raspatories FARABEUF-COLLIN	274
raspatories FOMON	277
raspatories JOSEPH	277
raspatories KOENIG	276
raspatories LAMBOTTE	274
raspatories LANGENBECK	275
raspatories MATSON	279
raspatories MATSON-ALEXANDER	279
raspatories OBWEGESER	462
raspatories SEMB	278
raspatories WILLIGER	276
raspatoriesium MOLT	276
raspatoriesium WIBERG	277
raspatories SEDILLOT	274, 275
raspatory HARGIS	463/2
raspatory SELDING	277
RAZOR blades	45
reamer KUENTSCHER	321
reamer KUENTSCHER	321
RECAMIER uterine curette	597
rectal suction tube BUJE	566
rectal biopsy forceps YEOMAN	566
rectal-specula ALAN-PARKS	561
rectal-specula BARR	559
rectal-specula BODENHAMMER	559
rectal-specula CZERNY	559
rectal-specula HILL-FERGUSON	560
rectal-specula MATHIEU	560
rectal-specula PRATT	559
rectal-specula SAWYER	560

rectal-specula SCHULZE-BERG	560
rectal-specula SIMS	559
rectum clamp HAYES	545
REDA tuning forc	403
REDA amputation knife	44
REDA blade breaker	45
REDA bone curettes	256
REDA bone hand drills	299
REDA bone holding forceps	246, 247
REDA cilia forceps	395
REDA cotton-applicator	203
REDA EXCENTER bandage scissors	69/2
REDA eye magnet	395
REDA Finger ring saw	297
REDA intestinal grasping forceps atrauma	111
REDA nose specula	423
REDA parametrium clamps	128/1
REDA plaster retractor	232
REDA sickle knives	435
REDA skin hook	150
REDA sterilization forceps	615
REDA suture fork	221/1
REDON guide needle	207
REES FACE LIFT scissors	73
REILL bone holding forceps	248
REINER ear syringe	407
REINER plaster knives	233
REKORD syringe	596
RESANO capsula scissors	53/2
RESANO Forceps	85
RESANO intestinal clamp	542
RESECTION knives	47
retractor ALM	168
retractor ANDERSON	198
retractor assembly	188
retractor AUFRANC	289
retractor breast	198
retractor BRUNNER	167
retractor COLLIN	139
retractor COLLIN HARTMANN	141
retractor COOLEY	148
retractor CORONAL BLOW LIFT	198
retractor CORYLLOS	166
retractor CRILE	140
retractor CUSHING	151
retractor CZERNY	141
retractor DAVIDSON (Scapula)	166
retractor DEAVER	145
retractor DEAVER GRIP	146
retractor DEBAKEY	189/1
retractor DELEE	574
retractor DESMARRES	151
retractor DESMARRES	151
retractor DOYEN	163
retractor DOYEN-STILLE	167
retractor FARABEUF	139
retractor FERRIERA	197
retractor FINSEN	168
retractor Freeman	198
retractor FRITSCH	163
retractor GIL-VERNET	152
retractor GOELET	141
retractor GREEN	160
retractor HARRINGTON	147
retractor HARRINGTON-PEMBERTON	147
retractor HASSON	143
retractor HEANEY	164
retractor HIBBS	164
retractor HOESEL	167
retractor HOFER	465
retractor HOLZHEIMER	168
retractor ISRAEL	162
retractor JACKSON-BURROWS	189/2
retractor JANSEN	168

retractor KELLY	164
retractor KELLY GRIP	142
retractor KLAPP	150
retractor KOCHER	155
retractor KOCHER	160, 163
retractor KOCHER-LANGENBECK	159
retractor KOERTE	162
retractor KÖNIG	153
retractor LAHEY	149, 157
retractor LAHEY	157
retractor LANGENBECK	158, 159
retractor LANGENBECK-GREEN	153
retractor LITTLE	157
retractor LOVE	465
retractor MARTIN	175/1
retractor MATHIEU	141
retractor MEYERDING	157, 177
retractor MEYERDING	177
retractor MIDDELORPF	160
retractor MIKULICZ	163
retractor MORRIS	164
retractor NAGER	465
retractor OBWEGESER	460, 461/1
retractor OLLIER	162
retractor PARKER	139
retractor RAGNELL	140
retractor RAMUS	461
retractor RICHARDSON	142
retractor RICHARDSON GRIP	142
retractor RICHARDSON-EASTMAN	142
retractor ROSE	140
retractor ROSS	148/1
retractor ROUX	139
retractor ROUX-BABY	140
retractor ROUX-MINI	140
retractor SAUERBRUCH	164
retractor SAUERBRUCH	164, 166
retractor SENN-GREEN	153
retractor SENN-MILLER	143
retractor SIMON	164
retractor SPINA-NASALIS	461
retractor TEBBETS	197
retractor TESSIER	463/3
retractor TUFFIER	147
retractor US-army PARKER-LANGENBECK	141
retractor VOLKMANN	153
retractor VOLKMANN	156
Retractor with treangle handle LANGENBECK-MANNERFELT	148/4
Retractor with treangle handle MANNERFELT	148/3, 148/4, 148/5
retractor YANCOSKIE	198
retractor ZENKER	161
retractors ADSON	173
retractors ADSON	172, 173, 174
retractors ANDERSON-ADSON	172
retractors BECKMANN	176
retractors BECKMANN-ADSON	175
retractors BECKMANN-EATON	176
retractors CASPAR	179, 180
retractors DARLING	178
retractors HENLEY	170
retractors MAYO-ADAMS	171
retractors MEYERDING	180
retractors MOLLISON	171
retractors NORFOLK NORWICH	172
retractors PERKINS	168
retractors PLESTER	171
retractors SCALP-CONTOUR	169
retractors TRAVERS	172
retractors WEITLANER	169
retractors WULLSTEIN	171
Retraktor PERCY	296
REVERDIN intestinal spatula	143/3

REVERDIN needle 220
 REYNOLDS supercut scissors 72
 REYNOLDS surgical scissors 54
 rhinoplastic scissors FOMON 65/1
 rib contractor SELLORS 489/1
 rib scissors 480
 rib scissors BETHUNE 481
 rib scissors BRUNNER 481
 rib scissors CORYLLOS 480
 rib scissors GIERTZ-STILLE 481
 rib scissors GLUCK 480
 rib scissors SAUERBRUCH 481
 rib scissors STILLE 480
 rib shears COLLIN 480
 rib spreader BAILEY 489/1
 rib spreader BAILEY-BABY 489/1
 rib spreader BAILEY-GIBBON 489/1
 rib spreader COOLEY 487
 rib spreader COOLEY-NEONATAL 485
 rib spreader FINOCCHIETTO 482, 484
 rib spreader FINOCCHIETTO-BURFORD 483
 rib spreader HAIGHT 487
 rib spreader MORSE 484
 rib spreader MORSE-FAVALORO 484
 rib spreader TUFFIER 487
 Rib Spreaders 487/2
 Rib Spreaders DE BAKEY 485/1
 RIBBON intestinal spatula 143/1
 RICARD abdominal retractor 191
 RICHARDSON retractor 142
 RICHARDSON-EASTMAN retractor 142
 RICHARDSON-GRIP retractor 142
 RICHTER-HEATH clip forceps 224
 RIGBY abdominal retractor 189/2
 RI-MINI Diagnostic set 17
 RING tongue depressors 455
 rings ligature 568
 RITTER-HALLE irrigation cannula 433
 ROBB spatula 530
 ROBERTS hemostatic clamp 117
 ROCHARD abdominal retractors 186
 ROCHESTER-CarmALT hemostatic clamp 109
 ROCHESTER-OCHSNER hemostatic clamp 108
 ROCHESTER-PEAN hemostatic clamp 108
 ROEDER towel clamp 132
 ROGER septum 437
 ROGERS hysterectomy clamp 127
 ROGGE sterilization forceps 227
 ROLLET EXTIRPATION chisels 374
 ROLLET extraction hook 375
 rongeur CITELLI 430
 rongeur DECKER 341
 rongeur FERRIS-SMITH-KERRISON 344, 344/2
 rongeur HAJEK-KOFLER 429, 431
 rongeur KERRISON 428
 rongeur PEAPOD 341/1
 ROSE retractor 140
 ROSEN knives 418
 ROSEN needle 419
 ROSEN suction tube 338
 ROSER-KOENIG 454
 ROSS retractor 148/1
 round ring medium 194
 ROUX MINI retractor 140
 ROUX retractor 139
 ROUX-BABY retractor 140
 ROWE reposition forceps 459
 RUBIN septum forceps 428
 RUDD haemorrhoidal ligator 568
 ruler metal 25
 RUMEL hemostatic clamp 117
 RUMEL-BELMONT tourniquet 528
 RUskin bone rongeur 239
 RUskin-LISTON bone cutting forceps 241

RUSS MODELL grasping tissue forceps 85
 RUSSEL-DAVIS mouth gag 458
 RYDEL-SEIFFERT tuning forc. 404
 RYDER needle holder 210

S

SAALFELD comedone extractor 608
 SACHS dura dissector 332
 SACHS nerve hook 328
 SAENGER ovum forceps 606
 sagittal split retractor SMITH 463/5
 SalpingographSCHULTZE 596
 SANVENERO surgical scissors 54/1
 SAROT hemostatic clamp 118
 SAROT needle holder 211
 SATINSKY tangential clamp 502
 SATINSKY vascular clamp 491
 SATINSKY vascular scissors 65/1
 SATTERLEE amputation saw 296
 SAUERBRUCH bone rongeur 240
 SAUERBRUCH retractor 164
 SAUERBRUCH retractor 164, 166
 SAUERBRUCH rib scissors 481
 SAUERBRUCH wasteforceps 227
 saw GIGLI 332
 SAWTELL tonsil forceps 467
 SAWYER rectal specula 560
 SAYRE elevator 281
 SCAGLIETTI bone rongeur 240
 scalp forceps GAUSS 605
 SCALP-CONTOUR retractors 169
 scalpel 46
 scalpel blade 42
 scalpel blade remover 42
 Scalpel Blades 42
 scalpel handle 38, 39, 39/1, 39/2, 40, 42
 scalpel handle COLLIN 40
 scalpel handle MINI 41
 Scalpel Handles 38-41
 Scalpel Handles BARRON 38
 scalpel MINI 41
 SCHAEDEL towel clamp 132
 SCHAMBERG comedone extractor 608
 SCHEDE bone curettes 251
 SCHEIE goniotomy knives 373
 SCHEINMANN interchangeable tips 472
 SCHERBAK vaginal specula 575
 SCHINK dermatome 49
 SCHIOETZ tonometer 394/2
 SCHLESINGER laminectomy retractor forceps 342
 SCHMIEDEN nose forceps 427
 Schmid vascular-irrigation cannula 338
 SCHMIEDEN guideprobes 221
 SCHMIEDEN-DICK ligaturee needle 219, 221
 SCHMIEDEN-TAYLOR durascissors 65/1
 SCHNIDT tonsil forceps 467
 SCHOENBORN thyroid gland hook 479
 SCHRÖDER hook forceps 583, 584
 SCHRÖDER uterine curette 595
 SCHROEDER(POZZI) hook forceps 582
 SCHUBERT biopsy forceps 588
 SCHUKNECHT knives 418
 SCHULTZE salpingograph 596
 SCHULZE-BERGMANN rectal-specula 560
 SCHUMACHER biopsy forceps 588, 589
 SCHUMACHER episotomy scissors 64
 SCHUMACHER interchangeable tips 472
 SCHUMACHER sternum scissors 481
 SCHWEIGGER capsular forceps 391
 scissors CASTROVIEJO 79
 scissors CASTROVIEJO 79
 scissors COTTLE 56
 scissors delicate, bipolar 634

scissors DOYEN 63
 scissors enterotomy 66
 scissors ENUCLEATION 58
 scissors GORNEY 73
 scissors GRAEFE 56
 scissors HEPP-SCHUIDEL 78
 scissors MARTIN CARTILAGE 65/1
 scissors McINDOE 65/1
 scissors micro 76
 scissors neurosurgical 65
 scissors Parametrium 63
 scissors REES 73
 scissors SIEBOLD 62
 scissors SIMS 62
 scissors standard bipolar 634
 scissors THOREK 65/2
 scissors WAGNER 67
 scissors WERTHEIM 63
 sclerotome GUYTON-LUNDSGAARD 373
 sclerotome LUNDGAARD 373
 SCOVILLE bone curette 253
 SCOVILLE hook 196
 SCOVILLE laminectomy retractor 196
 SCOVILLE nerve hook 329, 330
 SCOVILLE-HAVERFIELD laminectomy retractor 196
 screw driver 232
 screw driver LANE 323
 screw driver WILLIAMS 323
 SCUDDER intestinal clamp 541
 SEBILEAU elevator 275
 Section needle 268
 SEDILLOT raspatories 274
 SEGMENTED RING 194
 SEGOND hysterectomy clamp 125
 SEGOND-LANDAU hysterectomy clamp 125
 SEIFERT interchangeable tips 472
 SELDIN raspatory 277
 SELLHEIM obstetrical curette 607
 SELLORS rib contractor 489/1
 SEMB bone cutting forceps 242
 SEMB bone holding forceps 243
 SEMB bone rongeur 240
 SEMB bronchusclamp 491
 SEMB raspatories 278
 SEMKEN anatomic tissue forceps 86
 SEMKEN surgical tissue forceps 86
 SEMM vaginal specula 571
 SENN-GREEN retractor 573
 SENN-MILLER retractor 143
 septum cannula 406
 septum chisels CINELLI 441
 septum chisels COTTLE 440
 septum chisels FOMON 441
 septum chisels FREER 439
 septum chisels SHEEHAN 441
 septum chisels SILVER 442
 septum elevator BALLENGER 439
 septum elevator COTTLE 439
 septum elevator COTTLE-JOSEPH 439
 septum elevator FREER 437
 septum elevator HAJEK-BALLENGER 439
 septum elevator HALLE 437
 septum elevator HOWARTH 438
 septum elevator JOSEPH 437
 septum elevator KILLIAN 438
 septum elevator MASING 437
 septum elevator McKenty 437, 438
 septum elevator PENNINGTON 438
 septum elevator PIERCE 438
 septum elevator ROGER 437
 septum forceps BRUENINGS 425
 septum forceps HEYMANN 425
 septum forceps KNIGHT 425
 septum forceps LUC 426

septum forceps MIDDLETON-JANSEN	430	SMITHWICK applicator forceps	326	STEVENSON eye specula	371
septum forceps RUBIN	428	SMITHWICK nerve hook	328	STIEGLITZ splinter forceps	92
septum gouges FREER	442/1	SNELLEN cataract loop	378	STILLE anatomic tissue forceps	81
septum gouges HAJEK	442/1	SNELLEN Entropium forceps	393	STILLE chisels	260
septum gouges KILLIAN-CLAUS	442/1	SOMER uterine-grasping forceps	585	STILLE chisels	260
septum knives CONVERSE	435	spare blade	49	STILLE gouges	260
septum knives COTTLE	435	Spare lamps	33-34	STILLE hemostatic clamp	122
septum knives FREER	434	spatula	203, 530/1, 612	STILLE plaster scissors	229
septum knives JOSEPH	434, 435	SPATULA AND PACKER	612	STILLE rib scissors	480
septum scissors KILLIAN	471	spatula Hirschman	379	STILLE surgical tissue forceps	81
septum straightening forceps ASCH	449	specula FRIEDMANN	577	STILLE-BARRAYA vascular tissue forceps	88
septum straightening forceps WALSHAM	449	specula KALLMORGEN	573	STILLE-HORSLEY bone cutting forceps	242
SERPENTINE biopsy forceps	593	specula KRISTELLER	572	STILLE-LISTON bone cutting forceps	241
SEUTIN bandage scissors	69/2	specula O'SULLIVAN-O'CONNOR	576	STILLE-LUER bone rongeur	239
SEXTON ear knives	408	SPENCER suture scissors	66	STILLE-RUSKIN bone rongeur	239
SHAPLEIGH ear loop	410	SPENCER-WELLS hemostatic clamp	109	STOCKMANN penis clamp	553/1
SHAVER knives	49	Sphygmomanometer	5-6, 12	stomach clamp LANE	548
SHEA micro ear scissors	413	Sphygmomanometer	5-6, 12	stomach-intestinal clamp MIKULICZ	543
SHEEHAN chisels	441	Sphygmomanometer BABYPHON	10	STONE forceps	545
SHEETS eye cannula	394/2	Sphygmomanometer MINIMUS	12	Stone holding clamp	545
sickle knives REDA	435	SPINAL bone curettes	253	STONE-WATT	545
SIEBOLD gynecological scissors	62	Spinal hook TAYLOR	291	strabismus forceps BONACCOLTO	385
SIEGLE ear specula	402	SPINA-NASALIS retractor	461	strabismus forceps DASTOOR	386
Silver clips	326	splitterforceps ARCHER	92	strabismus forceps JAMESON	385
SILVER DERMATOM	50	splitterforceps PEET	92	strabismus forceps McCULLOUGH	385
SILVER septum chisels	442	splitterforceps VIRTUS (RALK)	92	strabismus hook JAMESON	375
SIMCOE irrigation cannula	394/2	splitterforceps STIEGLITZ	92	STRANDELL-STILLE retractor	157
SIMON retractor	164	splittertissue forceps	91	STRASSBURGER tissue forceps	89
SIMON uterine curette	594	splittertissue forceps CARMALT	91	STRATTE needle holder	212
SIMPSON obstetrical forceps	602	splittertissue forceps FEILCHENFELD	91	STRAUSS penis clamp	553/1
SIMPSON-BRAUN obstetrical forceps	602	splittertissue forceps HUNTER	91	Stringer	228
SIMPSON-LUIKART obstetrical forceps	603	spoon medicine	621	Stripper	202
SIMS gynecological scissors	62	SPRATT bone curettes	251	STRULLY neuro surgical	65
SIMS rectal-specula	559	spreader DAVIS-BOYLE	455	STRUYCKEN nose forceps	427
SIMS uterine curette	597	spreader DAVIS-MEYER	457	suction -irrigation cannula	394
SIMS uterine depressor	586	spreader DINGMANN	456	suction handle WULLSTEIN	338
SIMS uterine probes	586	spreader KILNER-DOUGHTY	456	suction raspatories GUILLEN	433/1
SIMS vaginal specula	573	spreader, Mammaria	487/1	suction tube ADSON	337
SIMS-MAIER dressing forceps	134	spreader, Sternum	487/1	suction tube ANDREW-PYNCHON	28
SINGLEY tissue forceps	88	SPURLING laminectomy retractor forceps	340	suction tube BABY-YANKAUER	27
Sinskey hook	376	srewholding forceps LANE	325	suction tube BARON	336
Sinus probes	438	ST. CLAIR-THOMSON adenoid curette	450	suction tube COOLEY	28
SINUS septum elevator	438	ST. MARKS pelvis hook	165	suction tube DASTOOR	380
sinuscopy forceps	431	ST. MARTIN tissue forceps	392	suction tube DEBAKEY	38
sinuscopy-trocar	205	STAMMBERGER forceps	431	suction tube FRAZIER/FERGUSSON	337
SKENE hook forceps	582	Standard bipolar scissors	634	suction tube HOUSE	337/2
skin hook COTTLE	447, 448	STAUDE-MOORE hook forceps	582	suction tube PLESTER	338
skin hook COTTLE-NEIVERT	448	STEINMANN ENDER nail	307, 308	suction tube POOLE	27
skin hook FOMON	447/1	STEINMANN tendon holding forceps	292	suction tube ROSEN	338
skin hook FRAZIER	148/2	STELLBRINK bone rongeur	234	suction tube tube KLEINSASSER	36
skin hook FREER	448	STERILE scalpel-blade	42	suction tube YANKAUER	27
skin hook GILLIES	448	STERILE spare blade	50	suction tube YASARGIL	337/1
skin hook GRAEFE	148/2	sterilization clamp BUNT	227	suction tube ZOELLNER	337/1
skin hook GUTHRIE	148/2	sterilization clamp MAYO	227	supercut scissors	71
skin hook JOSEPH	149	sterilization forceps	227	supercut scissors BABY METZENBAUM	71
skin hook KILNER	608	sterilization forceps	227	supercut scissors FREEMAN	74
skin hook KLEINERT-KUTZ	149	sterilization forceps CHEATLE	227	supercut scissors GORNEY	73
skin hook REDA	150	sterilization forceps REDA	615	supercut scissors IRIS	72
skin punch KEYE	608	sterilization forceps ROGGE	227	supercut scissors KAYE	73
skin scissors	610	sterilization forceps UNIVERSAL	227	supercut scissors KILNER/RAGNELL	72
skin straightening blade for dermatome	49	sterilization tray	622	supercut scissors LISTER	72
slip joint plier	317	sterilization tray	618	supercut scissors MAYO	71
SLS clip forceps	524	STERNBERG cheek retractor	453	supercut scissors MAYO-STILLE	71
SLUDER-BALLENGER	470	sternum scissors SCHUMACHER	481	supercut scissors METZENBAUM	71
SMELLIE hook	605	Sternum spreader	487/1	supercut scissors REES	73
SMELLIE perforators	607	Sternumchisels LEBSCHKE	267	supercut scissors REYNOLDS	72
SMILLIE bone levers	291	stethoscope ANESTOPHON	23	supercut scissors STEVENS	72
SMILLIE meniscus knives	292	stethoscope DUPLEX	23	supercut scissors WAGNER	72
SMITH ramus separator	463	stethoscope PINARD	23	surgical needle KEITH	223
SMITH sagittal split retractor	463/5	STEVENS iris tissue forceps	383	surgical needle KOENIG	223
SMITH US army bandage scissors	69/1	STEVENS lens hook	375	surgical scissors FERGUSSON	66
SMITH-BUIE ANAL retractor	561	STEVENS needle holder	214	surgical scissors fine IRIS	54/2
SMITH-PETERSEN	261	STEVENS ophthalmologic scissors	58	surgical scissors fine JOSEPH	54/1
SMITH-PETERSEN bone rongeur	238	STEVENS supercut scissors	72	surgical scissors fine KILNER	54/1

surgical scissors fine REYNOLDS	54/1
surgical scissors fine SANVENERO	54/1
surgical scissors METZENBAUM	51, 54/1
surgical scissors STANDARD	51
surgical scissors SYSTRUNK	66
surgical tissue forceps	81
surgical tissue forceps ADSON	81/2
surgical tissue forceps ADSON Micro	81/2
surgical tissue forceps ADSON-BROWN	82
surgical tissue forceps BONNEY	88
surgical tissue forceps BROPHY	84
surgical tissue forceps CUSHING	83
surgical tissue forceps FERRIS-SMITH	85
surgical tissue forceps GERALD	87
surgical tissue forceps GILLIES	86
surgical tissue forceps LANE	84
surgical tissue forceps OEHLER TC	81/1
surgical tissue forceps Potts Smith	81
surgical tissue forceps SEMKEN	86
surgical tissue forceps STILLE	81
surgical tissue forceps TAYLOR	87
surgical tissue forceps type USA	81/1
surgical tissue forceps WAUGH	83
suture fork REDA	221/1
suture scissors HEATH	66
suture scissors LITTAUER	66
suture scissors NORTHBENT	66
suture scissors SPENCER	66
SYSTRUNK surgical scissors	66

T

TABB knives	418
TAKAHASHI nose forceps	427
Tangentialclasp DeBAKEY-SATINSKY	502
TARNIER obstetrical forceps	604
TAYLOR percussion mallet	24
TAYLOR SPINAL hook	291
TAYLOR surgical tissue forceps	87
TC scissors FREEMAN	74
TC scissors PECK-JOSEPH	74
TC scissors REES	73
TC surgical scissors STANDARD	51
TC tissue forceps CUSHING	83
TC tissue forceps GILLIES	86
TC tissue forceps SEMKEN	86
TC tissue forceps surgical	81
TC tissue forceps WANGENSTEEN	89
TC tissue forcepsN ANATOMIC	81
TC-scissors Gorney	73
TC-scissors KAYE	73
TEALE hook forceps	583
TEBBETS retractor	197
teeth tissue forceps LONDON-COLLEGE	93
teeth tissue forceps MERIAM	93
tenaculum forceps ADAIR	582
tenaculum forceps POZZI-PALMER	582
tendon grasping forceps	293
tendon grasping forceps JACKSON	292
tendon grasping forceps LARSEN	292
tendon grasping instr KLEINERT-KUTZ	294
tendon grasping instrument BRAND	293
tendon grasping instrument CAROLL	293
tendon guide BUNELL	294
tendon holding forceps STEINMANN	292
tendon passing instr. BRAND	294
tendon passing instr. BUNNELL	292
TERRIER Hemostatic Forceps	106
TERSON capsular forceps	391
TESSIER retractor	463/3
T-handle	300, 301
T-handle HUDSON	300
THIERRY obstetrical forceps	603
THOMAS uterine curette	599

THOMAS-GAYLOR biopsy forceps	588
THOMAS-ALLIS intestinal grasping forceps	538
THOMSON-WALKER bladder retractors	552
THOREK scissors	65/2
THUDICHUM nose specula	421
thyroid gland hook SCHOENBORN	479
TIECK-HALLE nose specula	423
TILLEY ear forceps	411
TIP for suction tube	27
TISCHLER-DOWN biopsy forceps	591
TISCHLER-KEVORKIAN biopsy forceps	592
TISCHLER-MORGAN biopsy forceps	591
TISCHLER-MORGAN biopsy forceps	590, 591
TISCHLER-UP biopsy forceps	591
tissue forceps	90, 94
tissue forceps anatomic	81
tissue forceps bipolar	630, 631
tissue forceps BONNEY	88
tissue forceps BROWN	83
tissue forceps CASTROVIEJO	392
tissue forceps DAVIS	227
tissue forceps DeBakey	99
tissue forceps Gerald	86, 87
tissue forceps GOMEL	96
tissue forceps GRAEFE	83
tissue forceps jewelry	90
tissue forceps MAYO	89
tissue forceps McPHERSON	392
tissue forceps MOORFIELD	392
tissue forceps PAUFIQUE	392
tissue forceps SINGLEY	88
tissue forceps STRASSBURGER MODELL	89
tissue forceps type TUEBINGEN	392
tissue forceps ULTRA LIGHT	95
tissue forceps WAGENSTEEN	89
tissue forceps YASARGIL	97
tissue forceps St. MARTIN	392
tissue grasping forceps CHAPUT	110
tissue grasping forceps COLLIN	110
tissue grasping forceps TUFFIER	110
titanium clips	549
titanium HALSTED-MOSQUITO hemostatic clamp	105
titanium hemostatic clamp CRILE	107
titanium hemostatic clamp KELLY	106
titanium tissue forceps DEBAKEY	99
titanium-ATRAUMA-bulldog clamp	102
TOBOLD cotton-applicator	203
TOBOLD tongue depressors	453
TOENNIS dura dissector	332
TOENNIS hemostatic clamp	117
TOENNIS-ADSON dissecting scissors	65
TOHUKU towel clamp	132
tongue blade DOUGHTY	458
tongue depressors	451
tongue depressors ANDREW	452
tongue depressors BRUENINGS	451
tongue depressors BUCHWALD	451
tongue depressors DAVIS-BOYLE	455
tongue depressors DINGMANN	456
Tongue Depressors DOYEN	451
tongue depressors FRENZEL	451
tongue depressors HARTMANN	452
tongue depressors KILNER-DOUGHTY	456
tongue depressors KROENIG	451
tongue depressors MAYO	451
tongue depressors MORITZ-SCHMIDT	452
tongue depressors RING	455
tongue depressors RUSSEL-DAVIS	458
tongue depressors TOBOLD	453
tongue depressors WIEDER	452
tongue forceps COLLIN	453
tongue forceps YOUNG	453
tonometer SCHIOETZ	394/2
tonsil forceps Abraham	468

tonsil elevator HENKE	465
tonsil elevator HURD	465
tonsil elevator LOPEZ-REINKE	465
tonsil forceps BALLENGER	467
tonsil forceps BLOHMKE	467
tonsil forceps MARSCHIK	468
tonsil forceps NEGUS	467
tonsil forceps SAWTELL	467
tonsil forceps SCHNIDT	467
tonsil forceps TYDING	467
tonsil forceps WHITE	467
tonsil grasping forceps COLVER	467
tonsil knives ABRAHAM	466
tonsil knives BRUENINGS	466
tonsil knives CANFIELD	466
tonsil knives CARPENTER	465
tonsil knives FISHER	466
tonsil needle	470
tonsil needle CLAUS	466
tonsil needle DUPUY-WEISS	466
tonsil needle NAGER	466
tonsil needleTRELAT	466
tonsil scissors	59
tonsil scissors BOETTCHER	59
tonsil scissors DEAN	59
tonsil scissors GOOD	59
tonsil scissors PRINCE	59
tonsil snare BRUENINGS	468
tonsil snare EVES	468
tonsil syringe	470
tonsil wire	468
Tonsil-Elevators GWYNNE EVANS	465
tonsilotome SLUDER-BALLENGER	470
tonsilotome TYDING	469
TOOK corneal scarifier	373
Tourniquet RUMEL-BELMONT	528
towel clamp	133
towel clamp BACKHAUS	132
towel clamp BACKHAUS-clip	132
towel clamp BALL AND SOCKET	133
towel clamp BERNHARD	133
towel clamp DOYEN	133
towel clamp JONES	132
towel clamp JONES-clip	132
towel clamp LANE	133
towel clamp LORNA	133
towel clamp PEERS	132
towel clamp ROEDER	132
towel clamp SCHAEDEL	132
towel clamp TOHOKU	132
towel forceps OMBREDANNE (JACKSON)	133
TOWNLEY caliper	26
TOWNSEND biopsy forceps	591
TOWNSEND MINI biopsy forceps	591
TOWNSEND TISCHLER MINI biopsy forceps	591
TOYNBEE ear specula	399
trachea cannula LUER	479
trachea cannula WAGENER-MOSHER	477
trachea cannula CHEVALIER-JACK	479
trachea dilator LABORDE	476
trachea dilator TROUSSEAU	476
trachea dilator TROUSSEAU-BABY	476
trachea hook BOSE	476, 477
trachea hook ITERSON	477
trachea hook JACKSON	476
trachea hook NEWS	477
Trachoma forceps KNAPP-LUER	393
Transformer	22
TRAVIS retractors	172
tray	619
Tray universal	620
TRELAT tonsil needle	466
trocac COAKLEY	204
trocac DOUGLAS	204

trocar LICHTWITZ.....	204
trocar NELSON.....	205
trocar OCHSNER.....	205
trocar PIERCE.....	204
trocar UNIVERSAL.....	204
trocar Standard (NELSON).....	204
TROELTSCH ear forceps.....	424
TROEMNER percussion mallet.....	24
TROUSSEAU trachea dilator.....	476
TROUSSEAU-BABY trachea dilator.....	476
TROUTMAN iris tissue forceps.....	389
TROUTMAN iris tissue forceps.....	384, 389
TROUTMAN-CHRIS bladeBREAKERS.....	45
tubal catheter.....	596
tube milking roller.....	131
tubing clamp.....	129
tube milking roller BÜLOW-GUNAR-HEY.....	130
TÜBINGEN IRIS forceps.....	387
TÜBINGEN tissue forceps.....	392
Tubulus, gerade, einfach.....	267
TUFFIER retractor.....	147
TUFFIER rib spreader.....	487
TUFFIER tissue grasping forceps.....	110
Tumortissue forceps YASARGIL.....	97
tuning forc.....	404
tuning forc HARTMANN.....	403
tuning forc LUCAE.....	404
tuning forc REDA.....	403
tuning forc RYDEL-SEIFFERT.....	404
Tuning Forks.....	403-404
TURNBULL nail forceps.....	609
TYDING tonsil forceps.....	467
TYDING tonsilotome.....	469

U

UCKERMANN cotton-applicator.....	203
ULRICH bone holding forceps.....	248
ULRICH dressing forceps.....	135
Ultra-Light-tissue forceps atrauma.....	95
umbilical cord COLLIN.....	605
umbilical cord KANE.....	605
umbilical cord scissors BRAUN-STADLER.....	64
umbilical cord scissors BUSCH.....	64
umbilical cord scissors SCHUMACHER.....	64
umbilical cord scissors type USA.....	64
UNI I DIAGNOSTIK-BES.....	13
UNI III DIAGNOSTIK-BES.....	15
UNIVERSAL bandage scissors.....	70
UNIVERSAL endoscope assembly.....	188
Universal handle HUBER.....	472
UNIVERSAL sterilization forceps.....	227
Universal tray.....	620
UNIVERSAL trocar.....	204
UNIVERSAL wire scissors.....	67
UNNA comedone extractor.....	608
Urethrotome OTIS.....	553
Urinal Female.....	621/2
Urinal Male.....	621/2
US army retractor.....	141
USA anatomic tissue forceps.....	81
USA type umbilical cord scissors.....	64
uterine clamp GREEN-ARMYTAGE.....	605
uterine curette SIMON.....	594
uterine curette BLAKE.....	595
uterine curette BUMM.....	597
uterine curette GOURDET.....	599
uterine curette RECAMIER.....	597
uterine curette SCHRÖDER.....	595
uterine curette SIMS.....	597
uterine curette THOMAS.....	599
uterine depressor BRAUN.....	586
uterine depressor SIMS.....	586
uterine Dilatator GOODELL.....	581

uterine Dilatator HANK.....	580
uterine Dilatator HEGAR.....	578, 579
uterine Dilatator PRATT.....	580
uterine grasping forceps COLLIN.....	585
uterine grasping forceps DARTIGUES.....	585
uterine grasping forceps SOMER.....	585
uterine polyp forceps DOYEN.....	585
uterine polyp forceps KELLY.....	585
uterine polyp forceps NOTO.....	585
uterine-probes COLLIN.....	586
uterine-probes MARTIN.....	586
uterine-probes SIMS.....	586

V

vaginal specula.....	569
vaginal specula JACKSON.....	573
vaginal specula AUVARD.....	576
vaginal specula BREISKY.....	577
vaginal specula COLLIN.....	570
vaginal specula CUSCO.....	570
vaginal specula DOYEN.....	574
vaginal specula GRAVE.....	570
vaginal specula KRISTELLER.....	572
vaginal specula LANDAU.....	577
vaginal specula PEDERSON.....	570
vaginal specula SCHERBAK.....	575
vaginal specula SEMM.....	571
vaginal specula SIMS.....	573
vaginal specula VU-MORE.....	569
VALLEIX probes.....	586
VAN BUREN bone holding forceps.....	249
VAN BUREN dilation bougie.....	554
VAN DOREN biopsy forceps.....	588
VANNAS eye scissors.....	79
VARADY varix instrument.....	202
varicose vein probes NABATOFF.....	201
varix instrument VARADY.....	202
vascular clamp BAINBRIDGE.....	495/1, 495/2
vascular clamp COOLEY.....	518, 522
vascular clamp DALE.....	495
vascular clamp DARDIK.....	509/1
vascular clamp DEBAKEY.....	493-500, 502, 505-508, 512-517
vascular clamp DEBAKEY children.....	516
vascular clamp DEBAKEY-MIXTER.....	499/2
vascular clamp DEBAKEY-RUMEL.....	499
vascular clamp DIEFFENBACH.....	104
vascular clamp GLOVER.....	515
vascular clamp SATINSKY.....	491
vascular clip BIEMER.....	361
vascular clip MEHDORN.....	362
vascular clip MUELLER.....	365
vascular scissors DE BAKEY.....	61
vascular scissors DeBaKey TC.....	60
vascular scissors DIETRICH.....	60
vascular scissors FAVALORO.....	61
vascular scissors KELLY.....	61
vascular scissors KLINKENBERG-LOTH.....	65/2
vascular scissors POTTS-DE MARTEL.....	59
vascular scissors POTTS-SMITH.....	61
vascular scissors SATINSKY.....	65/1
vascular tissue forceps ADLERKREUTZ.....	84
vascular tissue forceps NELSON.....	89
vascular tissue forcepsSTILLE-BARRAYA.....	88
vascular-cannula SCHMID.....	338
vascular-dilator DE BAKEY / GARRETT.....	529
vascularissector ROBB.....	530
vasectomy clamp.....	553/2
VERBRUGGE bone holding forceps.....	245
VIENNA guide probes.....	221/1
VIENNA nose specula.....	421
VIRCHOW post mortem knives.....	48
VIRTUS(RALK) splinter forceps.....	92
VOLKMANN bone curettes.....	251

VOLKMANN curette.....	257
VOLKMANN retractor.....	153
VOLKMANN retractor.....	153, 156
VOLTOLINI nose specula.....	421
VU-MORE vaginal specula.....	569

W

WACHENFELDT clip tissue forceps.....	224
WADSWORTH-TODD.....	378
WAGENER-MOSHER trachea cannula.....	477
WAGNER hook.....	409
WAGNER laminectomy retractor forceps.....	343
Wagner scissors.....	67
WAGNER supercut scissors.....	72
WALDMANN episotomy scissors.....	64
WALLICH ovum curette.....	607
WALSHAM septum straightening forceps.....	449
WALTHER catheter.....	555
WALTON foreign body gouges.....	374
WALTON comedone extractor.....	608
WALTON Finger ring saw.....	297
WANGENSTEEN vascular tissue forceps.....	89
WARTENBERG PINWHEEL.....	25
waste forceps SAUERBRUCH.....	227
water jet pistol.....	626
WATSON DERMATOM.....	50
WATSON-CHEYNE.....	283
WATSON-CHEYNE probes.....	199
WATSON-WILLIAMS nose forceps.....	428
WAUGH surgical tissue forceps.....	83
WEBER aorta clamp.....	501
WEBER cataract loop.....	378
WEBSTER needle holder.....	208
WECKER eye scissors.....	75
WECKER iris spatula.....	378
WEEK eye specula.....	370
WEIL-BLAKESLEY nose forceps.....	426
WEITLANER retractors.....	169
WEITLANER-WULLSTEIN retractors.....	169
WELLER dissecting scissors.....	53/2
WELLS enucleation curette.....	378
WERTHEIM gynecological scissors.....	63
WERTHEIM hysterectomy clamp.....	124, 128
WERTHEIM hysterectomy scissors.....	63
WERTHEIM-CULLEN hysterectomy clamp.....	125
WEST nose chisels.....	442
WESTCOTT eye scissors.....	75
WESTMACOTT nose dressing forceps.....	424
WHEELER discision knives.....	373
WHITE tonsil forceps.....	467
WIBERG raspatoriesIUM.....	277
width ruler.....	594
WIEDER tongue depressors.....	452
WIENER antrum rasp.....	443
WIENER iris hook.....	375
WIGMORE plaster knives.....	229
WIKSTROEM hemostatic clamp.....	117
WILDE polyp snare.....	411
WILDE polyp snare.....	433/2
WILDE(TROELTSCH) ear forceps.....	410
WILDER cataract loop.....	378
WILDER dilator.....	381
WILLET MARTEL grasping forceps.....	110
WILLIAMS eye specula.....	370
WILLIAMS intestinal grasping forceps.....	539
WILLIAMS screw driver.....	323
WILLIGER curette.....	255, 257
WILLIGER mallet.....	271
WILLIGER raspatories.....	276
WINTER ovum forceps.....	606
wire cutter HERCULES.....	320/1 - 320/3
wire dispenser.....	310
wire forceps.....	317 - 320/3

wire forceps BERRY TC.....	319
wire forceps CORWIN-HEGAR TC.....	319
wire forceps MAYO-HABERISSER TC.....	319
wire grasping forceps.....	318
wire guide needle DEMEL.....	315
wire instrument DEMEL.....	315
wire instrument LOUTE.....	315
wiresaw OLIVECRONA.....	332
wirescissors UNIVERSAL.....	67
WITTNER biopsy forceps.....	589
WOLFF plaster forceps.....	233
WOODSON dura dissector.....	333
WORST probes.....	333
WRIGLEY obstetrical forceps.....	602
WULLSTEIN knives.....	418
WULLSTEIN micro-curette forceps.....	416
WULLSTEIN retractors.....	171
WULLSTEIN suction handle.....	338
WYLIE aortic clamp.....	501/1, 501/2

Y

YANCOSKIE retractor.....	198
YANKAUER suction tube.....	27
YASARGIL GALEAhook.....	330
YASARGIL suction tube.....	337/1
YASARGIL tumor tissue forceps.....	97
YEOMAN rectal biopsy forceps.....	566
YOUNG prostatic hook.....	550
YOUNG tongue forceps.....	453

Z

ZAUFAL ear lever.....	409
ZAUFAL-JANSEN bone rongeur.....	238
ZAUFAL-JANSEN ear lever.....	409
ZENKER hemostatic clamp.....	118
ZENKER retractor.....	161
ZIEGLER discision knives.....	373
ZIEGLER head mirror.....	21
ZIEGLER iris knives.....	372
ZIELKE gouges.....	264
ZOELLNER suction tube.....	337/1

A

Abraham bisturí para amígdalas	466
Abraham pinza para coger amígdalas	468
abre-boca Davis-Boyle	455
abre-boca Davis-Meyer	457
abre-boca Denhart	454
abre-boca Dingmann	456
abre-boca Doughty-Kilner	456
abre-boca Doyen-Jansen (Molt)	454
abre-boca Heister	454
abre-boca Jansen-Doyen (Molt)	454
abre-boca Jennings	454
abre-boca Kilner-Doughty	456
abre-boca Koenig-Roser	454
abre-boca Mclvor	457
abre-boca Molt (Doyen-Jansen)	454
abre-boca Roser-Koenig	454
aceite para instrumentos Instru Care	635
Adair pinza uterina	582
Adams-Mayo separador	171
adaptador para iluminación para amnioscopio	600
adenoidectomía - tonsilectomía DRAFFIN	459
adenoidectomía - tonsilectomía MAGAURAN	459
adenotomía LaForce	450
Adlerkreutz pinza de disección	84
Adson Anderson separador	172
Adson Baby pinza hemostática	113
Adson elevador	282
Adson gancho para dura-madre	329
Adson pinza de disección	812, 82
Adson pinza de protección	298
Adson pinza gubia	236
Adson pinza hemostática	112, 113
Adson pinza para hipofisis	334
Adson porta aguja	211
Adson separador	172-174
Adson tubo de aspiración	337
Adson-Beckmann separador	175
Adson-Brown pinza de disección	82
Adson-DeBakey pinza de disección	812
Adson-Toennis tijera	65
agrafe Michel	224
aguja Barbara	419
aguja de disección Bowman	374
aguja de guía para anestesia	206
aguja de guía Redon	207
aguja para amígdalas	470
aguja para autopsia	268
aguja para biopsia Menghini	206
aguja para catarata	374
aguja para cuerpos extraños	374
aguja para cuerpos extraños Francis	374
aguja para laringe	470
aguja para ligadura	218, 219
aguja para ligadura Cooper	219
aguja para ligadura Deschamps	218
aguja para ligadura Dick-Schmieden	219
aguja para ligadura Kronecker	219
aguja para ligadura Schmieden-Dick	219
aguja para paracentesis Lucae	408
aguja para paracentesis Politzer	408
aguja para sutura amígdalas Dupuy-Weiss	466
aguja para sutura amígdalas Weiss-Dupuy	466
aguja para sutura del paladar Claus	466
aguja para sutura del paladar Claus-Eicken	466
aguja para sutura del paladar Eicken-Claus	466
aguja para sutura del paladar Nager	466
aguja pasa-hilo Demel	315
aguja Reverdin	220
agujas de sutura	222, 223
Air Injection canula	394
alambre de Kirschner	306, 307
alambre de Steinmann	307, 308

alambres	306-308
Alan-Parks especulo rectal	561
Alderdyce elevador	282
Alexander cincel	259
Alexander gubia	259
Alexander periostotomo	276
Alexander pinza para biopsia	589
Alexander-Matson periostotomo	279
alicate corta-uñas	609, 612/2-614
alicate corta-uñas Anvil	613
alicate cuticular	613
alicate Grip	316
alicates para cortar uñas Turnbull	609
alicates	316-318, 320
alicates para alambres	317-320/3
alicates para alambres Hercules	320/1-320/3
alicates para cortar alambres	316-320
Allen pinza para apéndice	544
Allis pinza intestinal	537
Allis-Adair pinza intestinal	537
Allis-Baby pinza intestinal	537
Allis-Judd pinza intestinal	538
Allis-Lockwood pinza intestinal	538
Allison espátula pulmonar	489/2
Allis-Thoms pinza intestinal	538
Alm separador	168
Alvis cureta para cuerpos extraños	374
amigdalotomo Sluder-Ballenger	470
amigdalotomo Tyding	469
amniotomo	586, 600
amniotomo Beacham	586
Amsler-Connin marcador	380
Anderson Adson separador	172
Anderson separador	198
Anderson-Neivert cincel nasal	442
Andrew baja-lengua	452
Andrew-Pynchon tubo de aspiración	28
Anesthophon estetoscopio	23
anillo para Kleinsasser	36
anoscopio Chelsea-Eaton	563
anoscopio Hirschmann	562
anoscopio Ives-Fansler	562
anteojos para nistagmo Frenzel	20
Antrum cureta	435
Anvil alicate corta-uñas	613
aproximador de Biemer-Müller	363
aproximador de Müller	364
aproximador de Müller-Biemer	363
aproximador para costillas Baby-Bailey	489/1
aproximador para costillas Bailey	489/1
aproximador para costillas Bailey-Baby	489/1
aproximador para costillas Bailey-Gibbon	489/1
aproximador para costillas Gibbon-Bailey	489/1
aproximador para costillas Sellors	489/1
Archer pinza para espinas	92
Armytage-Green pinza para útero	605
Aruja biefarostato	370
Aruja pinza capsular	391
Aruja porta aguja	214
Aruja-Gill pinza capsular	390
Aruja-Kalt porta aguja	214
Arthur-Kirby pinza para fijación	385
articulación para Kleinsasser	36
asa Billeau	409
asa Langenbeck	409
asa Shapleigh	410
asa Snellen	378
asa Weber	378
asa Wilder	378
Asas de Laryngoskope	31-32, 34
Asch pinza para enderezar el tabique nasal	449
Aufricht-Cobra separador	289
Aufricht lima nasal	443
Aufricht retractor nasal	447

Auvard especulo vaginal	576
Axenfeld-Mellinger biefarostato	370
Ayer pinza para ligadura	393

B

Babcock pinza intestinal	539
Babinsky martillo de percusión	24
Baby Balfour separador abdominal	182, 183
Baby Burke pinza para biopsia	590
Baby Gosset separador abdominal	181
Baby Lexer tijera de disección	53
Baby Metzbaum tijera supercut	71
Baby Mixer pinza hemostática	119/1
Baby Roux separador	140
Baby-Bailey aproximador para costillas	489/1
Baby-Doyen pinza intestinal	540
Baby-Kocher pinza intestinal	540
Baby-Olsen-Hegar porta aguja	212
Baby-Overholt pinza hemostática	114
Baby-Payr pinza intestinal y estomacal	549
Baby-Tischler pinza para biopsia	592
Baby-Trousseau dilatador traqueal	476
Baby-Yankauer tubo de aspiración	27
Back holder separador abdominal	192-195
Backhaus pinza de campo	132
Backhaus-Clip pinza de campo	132
Bahnon-DeBakey pinza para aneurisma	506
Bailey aproximador para costillas	489/1
Bailey-Baby aproximador para costillas	489/1
Bailey-Gibbon aproximador para costillas	489/1
Bainbridge pinza hemostática	119/2
Bainbridge pinza vascular de uso múltiple	495/1-495/2
baja-lengua Andrew	452
baja-lengua Bruenings	451
baja-lengua Buchwald	451
baja-lengua Cawood-Minnesota	451
baja-lengua Davis-Russel	458
baja-lengua Doughty	458
baja-lengua Frenzel	451
baja-lengua Hartmann	452
baja-lengua Kroenig	451
baja-lengua Mayo	451
baja-lengua Minnesota-Cawood	451
baja-lengua Moritz-Schmidt	452
baja-lengua Ring	455
baja-lengua Russel-Davis	458
baja-lengua Schmidt-Moritz	452
baja-lengua Tobold	453
baja-lengua Wieder	452
baja-lenguas	451-453, 455
Baja-lenguas DOYEN	451
Bakes dilatador para conductos biliares	532
Balfour Baby separador abdominal	182, 183
Balfour separador abdominal	182, 183
Balfour-US separador abdominal	184
Ball and Socket pinza para campo	133
Ballenger cuchillo para tabique nasal	436
Ballenger elevador para el tabique nasal	439
Ballenger pinza para coger amígdalas	467
Ballenger-Hajak elevador para el tabique nasal	439
Ballenger-Sluder amigdalotomo	470
Ballentine-Heany pinza para histerectomía	127
bandejas	620
Bane-Hartmann pinza gubia	237
Baracani punta de pinza	472
Barbara aguja	419
Barbara gancho	419
Barbion-Lubet pinza nasal	424
Barnhill cuchillo para vegetaciones adenoides	450
Baron canula de succión	336
Barr especulo rectal	559
barra de tracción Gerster	250
Barraquer (Colibri) biefarostato	370

Barraquer (Colibri) pinza para iris	384	blerarostato Castroviejo	371	Buck-Gramcko elevador	285
Barraquer Colibri tijera para oftalmología.....	75	blerarostato Liebermann	371	Buie canula de aspiracion rectal	566
Barraquer cuchillo para queratoplastica.....	373	blerarostato Mueller	371	Buie-Smith separador rectal	561
Barraquer micro porta aguja	216, 217	blerarostato Park	371	bujia dilatadora Dittel	554
Barraquer pinza depiladora	395	blerarostato Stevenson	371	bujia dilatadora Guyon	554
Barraquer pinza para fijacion	390	Blohmke pinza para coger amigdalas	467	bujia dilatadora Van Buren	554
Barraquer-Katzin pinza para iris.....	384	Blount elevador	288	Bujias dilatadoras	554
Barraquer-Troutmann micro porta aguja.....	216	Blount separador para rodilla	289	Bülow-Gunar-Hey pinza cierra-tubo	130
Barraya-Stille pinza de diseccion	88	Blumenthal pinza gubia	236	Bumm cureta uterina	597
Barrett pinza uterina	582	Bodenhammer espejulo rectal	559	Bunell pasador de tendones	294
BARRON Mangos de bisturías	38	Boettcher tijera para amigdalas	59	Bunell perforador de mano.....	299
Baumgartner porta aguja.....	208	Böhler estribo para extension	312	Bunell separador para tendones	292
Beacham amniotomo	586	Böhler pinza cortante para huesos	241	Bunge cucharilla para exenteracion	378
Beck pinza para anastomosis	516, 520	Böhler pinza gubia.....	238	Bunt clip para esterilizacion	227
Becker quistotomo	375	Boies elevador.....	277	Burch horquilla fijadora	373
Beckmann cuchillo para vegetaciones adenoides	450	bomba de aire	295	Burch-Lister blefarostato	370
Beckmann separador	176	Bombilla de recambio.....	31-32	Burford-Finochietto separador costal	483
Beckmann-Adson separador	175	bombilla de repuesto para laringoscopia	29, 30	Burke pinza para biopsia.....	590
Beckmann-Eaton separador.....	176	bombonas.....	621	Burrows-Jackson separador	189/2
Beer pinza depiladora	395	Bonaccotto pinza para estrabismo	385	Busch tijera para cordon umbilical.....	64
Beeson separador para yesos	232	Bonn Mod. pinza para sutura	386	Bushe cucharilla cortante.....	256
Bellucci tijera auricular micro	413, 417	Bonn pinza para sutura	386		
Belmont-Rumel tournique.....	528	Bonney pinza de diseccion	88		
Bengolea pinza hemostatica	112	Bose gancho para traqueotomia	477		
Bennett elevador	283	Bose separador traqueal	476		
Bensaude protoscopio	565	Boucheran espejulo auricular.....	399		
Benson separador para piloro	544	Bowman aguja de discision.....	374		
Berens cuchillo de discision	372	Bowman blefarostato	370		
Bergmann martillo	272	Bowman sonda lacrimal	381		
Bergmann tijera para vendaje	69/1	Boyle-Davis abre-boca	455		
Bergmann-Schulze espejulo rectal.....	560	Boynton porta aguja	214		
Berke pinza muscular	389	Boys-Allis pinza intestinal	538		
Berlin Klinikum pinza cierra-tubo.....	129	Bozemann pinza porta esponja	138		
Berliner martillo de percusion	24	Bozemann porta aguja	211		
Bernhard pinza de campo	133	Bozemann-Douglas pinza porta esponja	138		
Berry pinza para torcer hilo	319	Brand mondador de tendones	294		
Bethune costotomo	481	Brand pinza de agarre para tendones	293		
Beyer pinza gubia	237, 238	Braun cranioclasto	607		
Biemer pinza para vasos	361	Braun depresor uterino	586		
Biemer-Müller aproximador	363	Braun gancho de decapitacion	607		
Bier sierra para amputacion	296	Braun pinza uterina	582		
Bill tractor	604	Braun-Stadler tijera para episiotomia	64		
Billeau asa	409	brazalete para brazo	295		
Bill-Luikart tractor	604	brazalete para femur	295		
bipolares tijeras delgada	634	Breast separador mamarío	198		
bipolares tijeras standard	634	Breisky espejulo vaginal	577		
Bircher-Ganske pinza para hueso	246	Bridge pinza hemostatica	116		
Birkett pinza hemostatica	116	Bristow elevador	290		
Bishop-Harman pinza para iris.....	386	Brodie sonda acanalada	199		
Bishop-Harmon canula de irrigacion y aspiracion	394/1	Brophy pinza de diseccion	84		
bisturi nasal Joseph.....	434, 435	Brown pinza de diseccion	83		
bisturi para amigdalas Abraham	466	Brown porta aguja	209		
bisturi para amigdalas Bruenings	466	Browne-Denis separador abdominal	185		
bisturi para amigdalas Canfield	466	Bruenings baja-lengua	451		
bisturi para amigdalas Fisher	466	Bruenings bisturi para amigdalas	466		
bisturías	46	Bruenings cierranudos	468		
Blake cureta uterina	595	Bruenings espejulo auricular	401		
Blake pinza para calculos biliares	530/2	Bruenings pinza nasal	425		
Blake-Mayo pinza para calculos biliares	530/2	Bruenings punta de pinza	472		
Blakesley-Weil pinza nasal	426	Bruenings tubo de extension	472		
blefarostato Arruga	370	Brunetti cincel	268		
blefarostato Axenfeld-Mellinger.....	370	Brunings-Lucas cincel	260		
blefarostato Barraquer (Colibri).....	370	Brünings-Lucas gubia.....	260		
blefarostato Bowman	370	Brunner costotomo	481		
blefarostato Burch-Lister	370	Brunner pinza intestinal	543		
blefarostato Clark	370	Brunner separador	167		
blefarostato Colibri (Barraquer).....	370	Brunner sonda conductora	221/1		
blefarostato Graefe	370	Bruns cucharilla cortante	251, 254		
blefarostato Lancaster	371	Bruns tijera para vendaje	70		
blefarostato Mellinger	370	Bryant pinza para medicacion	137		
blefarostato Murdock	370	Buchwald baja-lengua	451		
blefarostato Smith	370	Buck cureta	407		
blefarostato Week	370	Buck elevador para cuerpos extraños.....	412		
blefarostato Williams	370	Buck martillo de percusion	24		

C

Cables de conexión bipolares	633
caja para instrumentos	617
calibrador decimal Iwanson	227
calibre	26
calibre Townley	26
Canfield bisturi para amigdalas	466
canula Air Injection	394
canula capsular Jensen	394
canula de aspiracion para mango de Wullstein y Zöllner.....	337/1
canula de aspiracion rectal Buie	566
canula de aspiracion para mango de Zöllner y Wullstein.....	337/1
canula de inyeccion Kleinsasser	36
canula de irrigacion y aspiracion Bishop-Harmon	394/1
canula de irrigacion y aspiracion Harmon-Bishop	394/1
canula de succion Baron	336
canula de succion Kleinsasser	36
canula irrigacion Eicken (Killian)	433
canula irrigacion Killian (Eicken)	433
canula Killian	433/1
canula Lacrimal	394
canula lacrimal McIntyre	394
canula para lavador vascular Schmid	338
canula para traqueotomia Chevalier-Jackson	479
canula para traqueotomia Jackson-Chevalier	479
canula para traqueotomia Luer	479
canula para traqueotomia Mosher-Wagener	477
canula para traqueotomia Wagener-Mosher	477
canula Sheets	394/2
canula Simcoe	394/2
Captador de hilos VIENNA	221/1
Cargador para asas de	33
Carmalt pinza para espinas	91
Carmalt-Rochester pinza hemostatica	109
Caroll pinza de agarre para tendones	293
Carpenter cuchillo para amigdalas	465
Cartilage-Martin tijera	65/1
Caspar hemostatico	258
Caspar separador	179
Castaneda pinza vascular para neonatales	527
Castroviejo bleararostato	371
Castroviejo compas marcador.....	380
Castroviejo dilatador lacrimal	381
Castroviejo espátula para ciclodialisis	379
Castroviejo pinza capsular	391
Castroviejo pinza para fijacion	390
Castroviejo pinza para sutura	392
Castroviejo porta aguja	215
Castroviejo rompe hojas.....	45

Castroviejo tijera para corneales.....	79	clamp umbilical Collin	605	Coronal Blow Lift separador.....	198
Castroviejo tijera para iridectomia	79	clamp umbilical Kane	605	Corwin-Hegar pinza para torcer hilo	319
Castroviejo-Micro porta aguja	215	Clamps Atrauma Bulldog GREGORY	100	Coryllos (Thorax) separador.....	166
Castroviejo-Standard micro porta aguja.....	216	Clar lampara frontal.....	22	Coryllos costotomo	480
cateter auricular Hartmann.....	408	Clark blefarostato	370	Cos pinza auricular micro.....	414
cateter Coxeter.....	555	Claus aguja para sutura del paladar.....	466	costotomo	480, 481
cateter metalicos	555	Claus-Eicken aguja para sutura del paladar.....	466	costotomo Bethune	481
cateter Walther	555	Claus-Killian cincel nasal.....	442/1	costotomo Brunner	481
Catlin cuchillo para amputacion	44	Clayman gancho	376	costotomo Coryllos.....	480
cauterio Todd-Wadsworth	378	Cleveland pinza gubia	235	costotomo Frey-Sauerbruch.....	481
cauterio Wadsworth-Todd	378	clip para esterilizacion Bunt	227	costotomo Giertz-Stille	481
Cawood-Minnesota baja-lengua.....	451	clip para esterilizacion Mayo	227	costotomo Gluck.....	480
cepillo para uñas	611	Clip-Jones pinza de campo.....	132	costotomo Sauerbruch.....	481
cesta de esterilizacion	622	clips para vasos de Müller.....	365	costotomo Stille.....	480
Chandler elevador	282	Cloward pinza cortante para laminectomia.....	342	costotomo Stille-Giertz	481
Chaput pinza hemostatica.....	110	Cloward separador	178/1-178/4	costotomos COLLIN	480
Charley separador abdominal	289	Cloward separador para cuerpo vertebral.....	339	Cottle (Maltz) lima nasal.....	444
Charriere sierra para amputacion	296	Cloward separador para tejido cervical.....	339	Cottle cincel nasal	440
Cheatle pinza para esterilizacion	227	coagulacion bipolar	628-633	Cottle cuchillo rinoplastico.....	435
Chelsea-Eaton anoscopio	563	Coakley cureta para seno	449	Cottle elevador para el tabique nasal	439
Cheron pinza porta esponja.....	137	Coakley trocar para seno maxilar	204	Cottle especulo nasal.....	423
Cherry separador para laminectomia.....	488	Cobb cureta.....	252	Cottle gancho para la piel	448
Chevalier-Jackson canula para traqueotomia.....	479	Cobb gubia	262	Cottle Joseph elevador para el tabique nasal	439
Chevalier-Jackson pinza para bronco-esofagoscopia	473	Cobb periostotomo	280	Cottle martillo	273
Cheyne-Watson disecador.....	199	Cobra-Aufranc separador	289	Cottle pinza para columna.....	448
Cheyne-Watson elevador.....	283	Colclough pinza sacabocado		Cottle pinza para fijacion	410
Childe pinza para aplicar agrafes.....	224	para discos intervertebral	344/1	Cottle retractor nasal	447, 447/1
CHRISTOPHE Pinzas hemostáticas.....	107	Colibri (Barraquer) blefarostato	370	Cottle tijera nasal.....	59
cierra-nudo auricular Krause.....	411	Colibri (Troutman) pinza para iris.....	384	Cottle tijera para cirugía	56
cierra-nudo auricular Wilde	411	Colibri Barraquer tijera para oftalmologia.....	75	Cottle-Kazanjian pinza cortante para huesos	241
cierra-nudo rectal Yeoman	566	Colibri pinza para iris.....	384	Cottle-Neivert gancho para la piel.....	448
cierranudos Bruenings	468	College-London pinza dental.....	93	Coxeter cateter	555
cierranudos Eves.....	468	Coller-Crile pinza hemostatica	106	Crafoord pinza hemostatica	118
cincel	259-261, 264-265	Collier pelvimetro.....	605	Crafoord tijera pulmonar.....	65/2
cincel Alexander.....	259	Collier porta aguja.....	208	Crafoord-Sellors pinza hemostatica	119
cincel Brunetti.....	268	Collin clamp umbilical.....	605	Craig pinza para tabique nasal	426
cincel Brünings-Lucas	260	COLLIN costótomos	480	cranioclasto Braun	607
cincel de esternon Lebsche	267	Collin dinamómetro	25	Crego elevador.....	282
cincel Hibbs	265	Collin especulo vaginal	570	Crile gancho para nervio.....	328
cincel Lucas-Brünings	260	Collin histerometro	586	Crile pinza hemostatica	107
cincel nasal Anderson-Neivert.....	442	Collin Loktite separador abdominal.....	191	Crile porta aguja.....	213
cincel nasal Cinelli.....	441	Collin mango de bisturi.....	40	Crile separador	140
cincel nasal Claus-Killian.....	442/1	Collin martillo	270	Crile-Coller pinza hemostatica	106
cincel nasal Cottle	440	Collin pelvimetro.....	605	Crile-Murray porta aguja.....	209
cincel nasal Fomon	441	Collin pinza hemostatica	110	Crile-Rankin pinza hemostatica.....	107
cincel nasal Freer.....	442/1	Collin pinza para el utero	585	Crile-Wood porta aguja	209
cincel nasal Hajek	442/1	Collin pinza para quitar agrafes	224	Crutchfield perforador inicial.....	327
cincel nasal Killian	442/1	Collin pinza para tejido	539	Crutchfield pinza de traccion craneal	327
cincel nasal Killian-Claus.....	442/1	Collin pinza porta esponja	137	Cuadro metálico McKESSON	454/1
cincel nasal Neivert-Anderson.....	442	Collin pinza tira-lengua.....	453	cubeta para placenta	621/1
cincel nasal Rubin	440	Collin separador	139	cubeta Petri	620
cincel nasal Sheehan	441	Collin separador abdominal.....	190	cubetas.....	619-621/1
cincel nasal Silver.....	442	Collin-Duval pinza de diseccion	85	cuchara medicinal	268
cincel nasal West	442/1	Collin-Farabeuf periostotomo	274	cuchara para calculos biliares Desjardins.....	534
cincel para cuerpos extraños Dix.....	374	Collin-Hartmann separador	141	cuchara para calculos biliares Fergusson.....	533
cincel para el tabique nasal Freer	439	Collins-Mayo separador	141	cuchara para calculos biliares Koerte-Luer.....	533
cincel para extirpacion Rollet	374	Colver pinza para coger amígdalas.....	467	cuchara para calculos biliares Luer-Koerte.....	533
cincel Partsch.....	259	compas marcador Castroviejo.....	380	cuchara para calculos biliares Mayo.....	534
cincel Petersen-Smith	261	Cone pinza sacabocado craneal.....	331	cuchara y gancho Gross	409
cincel rompe-craneo.....	267	Contour-Scalp separador	169	cucharilla cortante	251-257
cincel Smith-Petersen	261	Converse cuchillo rinoplastico.....	435	cucharilla cortante Bruns	251, 254
cincel Stille.....	260	Converse separador.....	448	cucharilla cortante Bushe.....	256
cincel tamponador para huesos Passow	260	Cooley pinza atraumatica	99	cucharilla cortante Daubenspeck	255
Cinelli cincel nasal	441	Cooley pinza para anastomosis	519-520/1, 520/4	cucharilla cortante Halle	253
Circumflex micro tijera	76	Cooley pinza para cateter	510	cucharilla cortante Jacobson.....	257
Citelli pinza sacabocado.....	430	Cooley pinza vascular	520	cucharilla cortante Jansen.....	257
cizalla para yesos Stille.....	229	Cooley pinza vascular de uso multiple.....	518-520, 520/2	cucharilla cortante Lempert.....	256
clamp atrauma bulldog	100	Cooley pinza vascular pediatrica	522	cucharilla cortante Martini.....	257
clamp atrauma bulldog DeBakey	100, 103	Cooley separador.....	148	cucharilla cortante Reda.....	256
clamp atrauma bulldog Glover	100, 103	Cooley separador costal	485, 487	cucharilla cortante Schede	251
clamp bulldog de Titanio	102	Cooley-Derra pinza para anastomosis.....	519	cucharilla cortante Scoville.....	253
clamp bulldog DeBakey-Dietrich.....	101	Cooper aguja para ligadura.....	219	cucharilla cortante Spinal.....	253
clamp bulldog Dietrich	101	cooper graduadas.....	620	cucharilla cortante Spratt.....	251
clamp bulldog Dietrich-DeBakey	101	Cordes punta de pinza	472	cucharilla cortante Volkman	251, 257

cucharilla cortante Williger	255, 257
cucharilla para aborto Cuzzi	606
cucharilla para aborto Wallich	607
cucharilla para cataratas Daviel	377
cucharilla para cataratas Graefe	377
cucharilla para cataratas Knapp	378
cucharilla para chalazion Hebra	377
cucharilla para chalazion Meyhoefer	377
cucharilla para exenteracion Bunge	378
cucharilla uterina Simon	594
cucharra para sangre	268, 621
cuchillo auricular Politzer	408
cuchillo auricular Sexton	408
cuchillo corneal Gill	373
cuchillo corneal Took	373
cuchillo de discision Berens	372
cuchillo de discision Jaeger	372
cuchillo de hoz Reda	435
cuchillo intereseo	44
cuchillo para amigdales Carpenter	465
cuchillo para amputacion Catlin	44
cuchillo para amputacion Langenbeck	44
cuchillo para amputacion Liston	44
cuchillo para amputacion Reda	44
cuchillo para autopsia	48
cuchillo para autopsia Virchow	48
cuchillo para cataratas Deutschmann	371
cuchillo para cataratas Graefe	371
cuchillo para cerebro Virchow	48
cuchillo para discision Wheeler	373
cuchillo para discision Graefe	372
cuchillo para discision Ziegler	373
cuchillo para falanges	44
cuchillo para goniotomia Scheie	373
cuchillo para iris Dean	372
cuchillo para iris Ziegler	372
cuchillo para organos	48
cuchillo para periosio	47
cuchillo para queratoplastica Barraquer	373
cuchillo para queratoplastica Pauflue	373
cuchillo para reseccion	47
cuchillo para reseccion Langenbeck	47
cuchillo para tabique nasal Ballenger	436
cuchillo para tabique nasal Freer	434
cuchillo para vegetaciones adenoides Barnhill	450
cuchillo para vegetaciones adenoides Beckmann	450
cuchillo para vegetaciones adenoides St. Clair-Thomson	450
cuchillo para vegetaciones adenoides Thomson-St. Clair	450
cuchillo para vendaje enyesado Esmarch	233
cuchillo para vendaje enyesado Hopkins	233
cuchillo para vendaje enyesado Reiner	233
cuchillo para vendaje enyesado Wigmore	229
cuchillo Plester	418
cuchillo rinoplastico Converse	435
cuchillo rinoplastico Cottle	435
cuchillo Rosen	418
cuchillo Schulknecht	418
cuchillo Tabb	418
cuchillo Wullstein	418
Cullen-Wertheim pinza para histerectomia	125
cureta Antrum	435
cureta aspiradora	600
cureta aspiradora para biopsia uterina Novak	587
cureta aspiradora para biopsia uterina Randall	587
cureta Buck	407
cureta Cobb	252
cureta Faulkner	449
cureta House	420
cureta para aborto Pestalozza	606
cureta para biopsia Heany	587
cureta para biopsia Kevorkian	587
cureta para biopsia Mod. Muenchen	587

cureta para biopsia Muenchen Mod	587
cureta para cuerpos extraños Alvis	374
cureta para hipofisis	334
cureta para hipofisis Ray	334
cureta para lupus Fox	608
cureta para lupus Piffard	608
cureta para seno Coakley	449
cureta uterina Blake	595
cureta uterina Bumm	597
cureta uterina Gourdet	599
cureta uterina Recamier	597
cureta uterina Schröder	595
cureta uterina Sims	597
cureta uterina Thomas	599
Cusco especulo vaginal	570, 571
Cushing espátula cerebral	336, 369
Cushing gancho para nervio	328
Cushing pinza cortante para laminectomia	340
Cushing pinza de diseccion	83
Cushing separador	151-153
CUSHING taladro	298
Cushing-Taylor pinza de diseccion	87
Cuzzi cucharilla para aborto	606
Czerny especulo rectal	559
Czerny pinza uterina	584
Czerny separador	141

D

Dale pinza para vasos perifericos	495
Dandy gancho para nervio	328
Dandy pinza hemostatica	109
Darrik pinza vascular	509/1
Darling separador	178
Dartigues pinza para el utero	585
Dasstoor pinza para estrabismo	386
Daubenspeck cucharilla cortante	255
Davidson (Scapula) separador	166
Daviel cucharilla para cataratas	377
Davis elevador para duramadre	332
Davis espátula cerebral	337
Davis pinza para esterilizacion de jeringas	227
Davis-Boyle abre-boca	455
Davis-Meyer abre-boca	457
Davis-Russel baja-lengua	458
Day gancho auricular	409
DE BAKEY / GARRETT dilatador vascular	529
DE BAKEY SATINSKY Pinza para diseccion y ligatura	504/1
DE BAKEY Separadores costales	485/1
Dean cuchillo para iris	372
Dean tijera para amigdalas	59
Deaver separador	145, 146
Deaver tijera de diseccion	52
Deaver-Grip separador	146
DeBakey clamp atraumatico bulldog	100, 103
DeBakey pinza atraumatica	98, 99
DeBakey pinza para anastomosis	505, 515
DeBakey pinza para aneurisma de la aorta	496-498
DeBakey pinza para ligadura	493, 499-500
DeBakey pinza para vasos perifericos	494
DeBakey pinza vascular de uso multiple	495/2, 507, 508, 514, 515
DeBakey pinza vascular pediatrica	516, 517
DeBakey porta aguja	210
DeBakey separador	189/1
DeBakey tijera	60
DeBakey tijera vascular	61
DeBakey-Bahnson pinza para aneurisma	506
DeBakey-Dietrich clamp bulldog	101
DeBakey-Mixter pinza para ligaduras	499/2
DeBakey-Morris pinza para la aorta	506
DeBakey-Mosquito pinza hemostatica	509
DeBakey-Pean pinza hemostatica atraumatica	513

DeBakey-Rankin pinza hemostatica atraumatica	512
DeBakey-Rumel pinza para ligaduras	499
DeBakey-Satinsky pinza para occlusion tangencial	502
DeBakey-Semb pinza para ligadura y la aorta	499
Decker pinza cortante para laminectomia	341
Dejerine martillo de percusion	24
Delee especulo vaginal	574
DeLee forceps obstetrico	602
delgada tijeras bipolares	634
DeMartel guia conductora	330
DeMartel-Wolfson pinza para anastomosis	546-547
DeMartel-Wolfson pinza para cerrar clamps	546-547
DeMartel-Wolfson porta-clamps	546-547
Demel aguja pasa-hilo	315
Demel tensor de cierra-hilo	315
Denhart abre-boca	454
DENIS- BROWNE Pinzas de diseccion, sin/con dientes	89
Denis-Browne separador abdominal	185
depressor uterino Braun	586
depressor uterino Sims	586
Derf porta aguja	208
dermatomo Humby	50
dermatomo Schink	49
dermatomo Silver	50
dermatomo Watson	50
Derra pinza para anastomosis	515
Derra-Cooley pinza para anastomosis	519
D'Errico separador para la raiz de nervios	329/2
Deschamps aguja para ligadura	218
Desjardins cuchara para calculos biliares	534
Desjardins explorador para calculos biliares	531
Desjardins pinza hemostatica	121
Desjardins pinza para calculos biliares	530/2
Desmarres pinza para chalazion	393
Desmarres separador	151
desoblitador de vena	202
destornillador	323, 324
destornillador Lane	323, 324
destornillador Williams	323
Deutschmann cuchillo para cataratas	371
Devilbiss pinza sacabocado craneal	332
diapason Hartmann	403
diapason Reda	403
Diapasones	403
diapason Lucae	404
diapason Rydel-Seiffert	404
diapason Seiffert-Rydel	404
diapasones	403, 404
Dick-Schmieden aguja para ligadura	219
Diefenbach serra-fina	104
Dieter pinza auricular micro	414
Dietrich clamp bulldog	101
Dietrich pinza para la aorta	510
Dietrich tijera vascular	60
Dietrich-DeBakey clamp bulldog	101
dilatador lacrimal Castroviejo	381
dilatador lacrimal Wilder	381
dilatador para conductos biliares Bakes	532
dilatador para el seno Halle-Ritter	433
dilatador para el seno Ritter-Halle	433
dilatador traqueal Baby-Trousseau	476
dilatador traqueal Laborde	476
dilatador traqueal Trousseau-Baby	476
dilatador uterino Goodell	581
dilatador uterino Hank	580
dilatador uterino Hegar	578, 579
dilatador uterino Pratt	580
dilatador vascular DE BAKEY / GARRETT	529
dinamómetro Collin	25
Dingman elevador	463/3
DeBakey-Mixter pinza para ligaduras	463
Dingmann abre-boca	456
Dingmann pinza para hueso	246
disecador Cheyne-Watson	199

disecador corneal Green.....	374	elevador Hohmann-Lange.....	286	esfigmomanometro Minimus III.....	12
disecador corneal Paton.....	373	elevador Key.....	282	Esmarch cuchillo para vendaje enyesado.....	233
disecador para el saco lacrimal Lang.....	378	elevador König.....	284	Esmarch tijera para vendaje.....	69/2
disecador vascular Robb.....	530	elevador Lane.....	290	Esmarch vendaje de compresion.....	296
disecador Watson-Cheyne.....	199	elevador Lane Trethowan.....	290	espátula.....	143/1-144, 203, 336-337, 369, 378-379, 489/2, 530, 552, 612/1
disector Fisch.....	420	elevador Lane-Murphy.....	283	espátula abdominal Haberer.....	143/3
disector Gomey.....	277	elevador Lange-Hohmann.....	286	espátula abdominal Kader.....	143/3
dispensador de cepillos.....	611	elevador Masing.....	437	espátula abdominal Kümmel.....	143/4, 144
dispensador para brocas filiformes.....	310	elevador McDonald.....	283	espátula abdominal Rübner.....	143/1
Dittel bujía dilatadora.....	554	elevador Mini Hohmann.....	286	espátula cerebral Cushing.....	336, 369
Dix cincel para cuerpos extraños.....	374	elevador Müller-Verbrugge.....	286/2	espátula cerebral Davis.....	337
Dix instrumento para cuerpo extraños.....	380	elevador Murphy-Lane.....	283	espátula cerebral Heifetz.....	369
Doren pinza para biopsia.....	588	elevador Obwegeser.....	461/1	espátula cerebral Olivecrona.....	336
Doughty baja-lengua.....	458	elevador para amígdalas Reinke-Lopez.....	465	espátula Locke.....	612/1
Doughty-Kilner abre-boca.....	456	elevador para amígdalas Henke.....	465	espátula para ciclodialisís Castroviejo.....	379
Douglas pinza depiladora.....	395	elevador para amígdalas Hurd.....	465	espátula para ciclodialisís Elschnig.....	379
Douglas trocar.....	204	elevador para amígdalas Lopez-Reinke.....	465	espátula para ciclodialisís Hirschman.....	379
Douglas-Bozemann pinza porta esponja.....	138	elevador para cuerpos extraños Buck.....	412	espátula para enucleacion Wells.....	378
Down-Mini-Townsend pinza para biopsia.....	591	elevador para cuerpos extraños Quire.....	412	espátula para iris Wecker.....	378
Down-Tischler pinza para biopsia.....	591	elevador para duramadre.....	332, 333	espátula para la íntima Robb.....	530
DOYEN Baja-lenguas.....	451	elevador para duramadre Davis.....	332	espátula pulmonar Allison.....	489/2
Doyen especulo vaginal.....	574	elevador para duramadre Frazier.....	333	espátula vesical Kocher.....	552
Doyen estilote acanalado.....	199	elevador para duramadre Hoen.....	333	espátula vesical Legueu.....	552
DOYEN Martillos.....	271	elevador para duramadre Horsley.....	333	espátulas abdominales.....	143-144
Doyen periostotomo.....	278	elevador para duramadre Milligan.....	332	espátulas para la íntima.....	530-530/1
Doyen pinza de campo.....	133	elevador para duramadre Olivecrona.....	332	especulo auricular.....	399-402
Doyen pinza intestinal.....	540	elevador para duramadre Penfield.....	333	especulo auricular Boucheron.....	399
Doyen pinza para polipos uterinos.....	585	elevador para duramadre Sachs.....	332	especulo auricular Bruening.....	401
Doyen separador.....	163	elevador para duramadre Toennis.....	332	especulo auricular Gruber.....	399
Doyen separador abdominal.....	189/1	elevador para duramadre Woodson.....	333	especulo auricular Hartmann.....	399
Doyen tijera ginecológica.....	63	elevador para el tabique nasal Ballenger.....	439	especulo auricular Holmgren-Richnau.....	400
Doyen tirabuzon para fibroma.....	594	elevador para el tabique nasal Ballenger-Hajek.....	439	especulo auricular Poltzer.....	399
Doyen-Baby pinza intestinal.....	540	elevador para el tabique nasal Cottle.....	439	especulo auricular Siegle.....	402
Doyen-Jansen (Molt) abre-boca.....	454	elevador para el tabique nasal Cottle Joseph.....	439	especulo auricular Toynebe.....	399
Doyen-Stille separador.....	167	elevador para el tabique nasal Freer.....	437	especulo endocervical Kogan.....	577
DRAFFIN adenoidectomía - tonsilectomía.....	459	elevador para el tabique nasal Hajek-Ballenger.....	439	especulo Friedmann.....	477, 577
Dubois tijera ginecológica.....	63	elevador para el tabique nasal Halle.....	437	especulo nasal.....	421-423
Duehrsen pinza de diseccion.....	84	elevador para el tabique nasal Howarth.....	438	especulo nasal Cottle.....	423
Duplay pinza porta-esponja.....	134	elevador para el tabique nasal Joseph.....	437	especulo nasal Halle-Hartmann.....	421
Duplay pinza uterina.....	582	elevador para el tabique nasal Joseph Cottle.....	439	especulo nasal Halle-Tieck.....	423
Duplex stetoscopio.....	23	elevador para el tabique nasal Killian.....	438, 439	especulo nasal Hartmann.....	422
Dupuy-Weiss aguja para sutura amígdalas.....	466	elevador para el tabique nasal Killian.....	438, 439	especulo nasal Hartmann-Halle.....	423
Durante pinza de diseccion.....	88	elevador para el tabique nasal Masing.....	437	especulo nasal Killian.....	421
Duval pinza de diseccion.....	85	elevador para el tabique nasal McKenty.....	437, 438	especulo nasal Mod. Vienna.....	421
Duval pinza para tejido.....	539	elevador para el tabique nasal Pennington.....	438	especulo nasal Reda.....	423
Duval-Collin pinza de diseccion.....	85	elevador para el tabique nasal Pierce.....	438	especulo nasal Thudichum.....	421
		elevador para el tabique nasal Roger.....	437	especulo nasal Tieck-Halle.....	423
		elevador Sayre.....	281	especulo nasal Vienna Mod.....	421
		elevador Trethowan Lane.....	290	especulo nasal Voltolini.....	421
		elevador Verbrugge-Müller.....	286/2	especulo rectal.....	559-561
		elevador Watson-Cheyne.....	283	especulo rectal Alan-Parks.....	561
		Elevadores para amígdalas, GWYNNE EVANS.....	465	especulo rectal Barr.....	559
		Elevadores para huesos HAYES.....	284	especulo rectal Bergmann-Schulze.....	560
		Elevadores para huesos LAMBOTTE.....	287	especulo rectal Bodenhammer.....	559
		Elliot forceps obstetrico.....	603	especulo rectal Czerny.....	559
		Elschnig espátula para ciclodialisís.....	379	especulo rectal Ferguson-Hill.....	560
		Elschnig pinza capsular.....	391	especulo rectal Hill-Ferguson.....	560
		Elschnig pinza para fijacion.....	389	especulo rectal Mathieu.....	560
		Emmet gancho para fistulas.....	594	especulo rectal Parks-Alan.....	561
		Empujador de alambres Erich.....	461/2	especulo rectal Pratt.....	559
		Engel sierra para vendajes enyesados.....	229	especulo rectal Sawyer.....	560
		Enucleation tijera.....	58	especulo rectal Schulze-Bergmann.....	560
		Epker osteotomo.....	464/2	especulo rectal Sims.....	559
		Eppendorfer pinza para biopsia.....	590	especulo vaginal.....	569-577
		Erich empujador de alambres.....	461/2	especulo vaginal Auward.....	576
		ERRICO taladro.....	298	especulo vaginal Breisky.....	577
		escariador.....	304	especulo vaginal Collin.....	570
		escariador Perthes.....	304	especulo vaginal Cusco.....	570, 571
		esclerotomo Guyton-Lundsgaard.....	373	especulo vaginal Delee.....	574
		esclerotomo Lundsgaard.....	373	especulo vaginal Doyen.....	574
		esclerotomo Lundsgaard-Guyton.....	373	especulo vaginal Grave.....	570
		escofina nasal Miller.....	444	especulo vaginal Jackson.....	573
		escofina nasal Peet.....	446		
		escofina nasal Wiener.....	443		
		esfigmomanómetro.....	5-6, 12		

E

Eastman-Richardson separador.....	142
Eaton-Chelsea anoscopio.....	563
Echlin pinza gubia.....	240
ECO „T“ y „C“ estuche de diagnóstico.....	16
Eicken (Killian) canula irrigacion.....	433
Eicken-Claus aguja para sutura del paladar.....	466
electrocirugía.....	628-634
elevador.....	281-291
elevador Adson.....	282
elevador Alderdyce.....	282
elevador auricular Jansen-Zaufal.....	409
elevador auricular Zaufal.....	409
elevador auricular Zaufal-Jansen.....	409
elevador Bennett.....	283
elevador Blount.....	288
elevador Boies.....	277
elevador Bristow.....	290
elevador Buck-Gramcko.....	285
elevador Chandler.....	282
elevador Cheyne-Watson.....	283
elevador Crego.....	282
elevador Dingman.....	463/3
elevador Gramcko-Buck.....	285
elevador Hohmann.....	284, 285
elevador Hohmann Mini.....	286

especulo vaginal Joll.....	477, 577
especulo vaginal Kallmorgen.....	573
especulo vaginal Kristeller.....	572
especulo vaginal Landau.....	577
especulo vaginal More-Vu.....	569
especulo vaginal O'Connor-O'Sullivan.....	576
especulo vaginal O'Sullivan-O'Connor.....	576
especulo vaginal Pederson.....	570
especulo vaginal Scherbak.....	575
especulo vaginal Semm.....	571
especulo vaginal Sims.....	573
especulo vaginal Vu-More.....	569
espejo laringeo.....	423, 473
espejo laringeo Michel.....	423
estetoscopio Anestophon.....	23
estetoscopio Duplex.....	23
estetoscopio Pinard.....	23
estilete abotonado.....	199
estilete acanalado abotonado.....	199
estilete acanalado Doyen.....	199
estilete hoja mirte.....	199
estribo para extension Böhler.....	312
estribo para extension Kirschner.....	312
estribo para extension Kirschner U.S.....	312
estribo para extension U.S. Kirschner.....	312
estuche de diagnostico Ri-Mini.....	17
estuche de diagnostico Uni I.....	13
estuche de diagnostico Uni II.....	14
estuche de diagnostico Uni III.....	15
estuche para autopsia.....	269
estuche para esterilizar agujas.....	615
Eves cierranudos.....	468
explorador para calculos biliares Desjardins.....	531
explorador para calculos biliares Moynihan.....	531
Exploradores para cálculos biliares OCHSNER.....	531
extractor Küntscher.....	322
extractor/impactor para clavos.....	321-322/1

F

face lift tijera Freeman.....	73
face lift tijera Gorney.....	73
face lift tijera Joseph Peck.....	73
face lift tijera kaye.....	73
face lift tijera Peck Joseph.....	73
face lift tijera Rees.....	73
Fansler protoscopio.....	564
Fansler-Ives anoscopio.....	562
Farabeuf periostotomo.....	274
Farabeuf pinza para hueso.....	243
Farabeuf separador.....	139
Farabeuf-Collin periostotomo.....	274
Farabeuf-Lamotte pinza para hueso.....	243
Farrell porta-algodon.....	203
Faulkner cureta.....	449
Faure pinza para biopsia.....	588
Faure pinza para peritoneo.....	123
Favaloro tijera vascular.....	61
Favaloro-Morse separador costal.....	484
Fehland pinza intestinal.....	542
Felchenfeld pinza para espinas.....	91
Feldheim pinza para huesos.....	249
Female Taza del orinal.....	621/2
Ferguson-Hill especulo rectal.....	560
Fergusson cuchara para calculos biliares.....	533
Fergusson pinza hemostatica.....	109
Fergusson pinza para hueso.....	243
Fergusson tijera para intestino.....	66
Fergusson tubo de aspiracion.....	337
Fergusson/Frazier tubo de aspiracion.....	337
Ferriera separador para cirugia plastica.....	197
Ferris-Smith pinza cortante para laminectomia.....	343
Ferris-Smith pinza de diseccion.....	85
Ferris-Smith-Kerrison pinza sacabocado para	

discos intervertebral.....	344, 344/2
Finochietto pinza bronquial.....	490
Finochietto porta aguja.....	211
Finochietto separador costal.....	482, 484
Finochietto-Burford separador costal.....	483
Finsen separador.....	168
FINSTERER Tubos de aspiración.....	28
Fisch disector.....	420
Fisch gancho para duramadre.....	335
Fischer pinza para iris.....	384
Fish sonda.....	199
Fisher bisturí para amígdalas.....	466
Foerster pinza para iris.....	383
Foerster porta esponjas.....	136
Fomon cincel nasal.....	441
Fomon gancho nasal.....	447/1
Fomon lima nasal.....	444, 445
Fomon periostotomo.....	277
Fomon tijera nasal.....	58
Fomon tijera para rinoplastia.....	65/1
forceps obstetrico Braun-Simpson.....	602
forceps obstetrico DeLee.....	602
forceps obstetrico Elliot.....	603
forceps obstetrico Kielland.....	602
forceps obstetrico Kielland-Luikart.....	603
forceps obstetrico Luikart.....	603
forceps obstetrico Luikart-Kielland.....	603
forceps obstetrico Luikart-Simpson.....	603
forceps obstetrico McLean.....	603/1
forceps obstetrico McLean-Tucker-Luikart.....	603/1
forceps obstetrico Naegele.....	603
forceps obstetrico Piper.....	604
forceps obstetrico Simpson.....	602
forceps obstetrico Simpson-Braun.....	602
forceps obstetrico Simpson-Luikart.....	603
forceps obstetrico Tarnier.....	604
forceps obstetrico Tucker-Luikart-McLean.....	603/1
forceps obstetrico Tucker-McLean.....	603/1
forceps obstetrico Wrigley.....	602
forceps obstetricos Luikart-McLean.....	603/1
forceps obstetricos McLean-Luikart.....	603/1
forceps obstetricos Thierry.....	603
Fox cureta para lupus.....	608
Fox-Goldmann tijera para encias.....	67
Fraenkel pinza para laringe.....	471
Fraenkel punta de pinza.....	472
Francis aguja para cuerpos extraños.....	374
Frazier elevador para duramadre.....	333
Frazier gancho.....	148/2
Frazier separador abdominal.....	181
Frazier/Fergusson tubo de aspiracion.....	337
Freeman separador.....	198
Freeman tijera face lift.....	73
Freer cincel nasal.....	442/1
Freer cincel para el tabique nasal.....	439
Freer cuchillo para tabique nasal.....	434
Freer elevador para el tabique nasal.....	437
Freer gancho para la piel.....	448
Frenzel anteojos para nistagmo.....	20
Frenzel baja-lengua.....	451
Frey-Sauerbruch costotomo.....	481
Friedmann especulo.....	477, 577
Friedmann micro pinza gubia.....	234
Friedmann mini pinza gubia.....	234
Friedmann pinza gubia.....	234
Friedmann separador.....	477, 577
Fritsch separador.....	163
Frykholm pinza gubia.....	240
Fuchs pinza capsular.....	391
Fuchsig pinza hemostatica.....	113
Gallagher lima para seno.....	446

G

gancho Frazier.....	148/2
gancho Graefe.....	148/2
gancho Guthrie.....	148/2
gancho Joseph.....	149
gancho Kleinert-Kutz.....	149
gancho Kutz-Kleinert.....	149
gancho LAHEY.....	149
gancho nasal Fomon.....	447/1
gancho abotonado Lucae.....	409
gancho abotonado Wagener.....	409
gancho auricular Day.....	409
gancho Barbara.....	419
gancho Clayman.....	376
gancho cutaneo Kilner.....	608
gancho de decapitacion Braun.....	607
gancho de menton Obwegeser.....	461/1
gancho extractor.....	322
gancho Gass.....	376
gancho Kirschner.....	313
gancho Klapp.....	150
gancho Knapp.....	375
gancho McGee.....	419
gancho muscular.....	267, 375
gancho muscular Green.....	375
gancho obstetrico Smellie.....	605
gancho para cristalino Stevens.....	375
gancho para duramadre.....	335
gancho para duramadre Adson.....	329
gancho para duramadre Fisch.....	335
gancho para estrabismo Graefe.....	375
gancho para estrabismo Jameson.....	375
gancho para fistulas Emmet.....	594
gancho para galea Yasargil.....	330
gancho para iris O'Conner.....	375
gancho para iris Wiener.....	375
gancho para la piel Cottle.....	448
gancho para la piel Cottle-Neivert.....	448
gancho para la piel Freer.....	448
gancho para la piel Gillies.....	448
gancho para la piel Neivert-Cottle.....	448
gancho para las alas de la nariz Lange.....	448
gancho para nervio Crile.....	328
gancho para nervio Cushing.....	328
gancho para nervio Dandy.....	328
gancho para nervio Graham.....	329
gancho para nervio Krayernbühl.....	336
gancho para nervio Sachs.....	329
gancho para nervio Smithwick.....	329
gancho para sacar el inserto I.U.D.....	593
gancho para traqueotomia Bose.....	477
gancho para traqueotomia Iterson.....	477
gancho para traqueotomia Jackson.....	476
gancho para traqueotomia News.....	477
gancho Reda.....	150
gancho Rollet.....	375
gancho Rosen.....	419
gancho Shambaugh.....	419
gancho Sinskey.....	376
gancho y cuchara Gross.....	409
ganchos.....	419
ganchos en forma de silla LAHEY.....	149
garrote de madera Maulder.....	459
Gass gancho.....	376
Gauss pinza para pericraneio.....	605
Gaylor-Thomas pinza para biopsia.....	588
Geissendoerfer-Overholt pinza hemostatica.....	114
Gelpi separador perineal.....	189/1, 189/2
Gemini pinza hemostatica.....	115
Gerald pinza de diseccion.....	86, 87
Gerster barra de traccion.....	250
Gerzog martillo.....	270
Gibbon-Bailey aproximador para costillas.....	489/1
Gierzt-Stille costotomo.....	481
Gigli mango para sierra hilo.....	332

I

I.U.D. gancho para sacar el inserto 593
 iman ocular Reda 395
 impactor final Kuentscher 321
 impactor/extractor para clavos 321-322/1
 Inge separador para cuerpo vertebral 339
 Ingrown instrumento para uña 612/1
 Instru Care aceite para instrumentos 635
 Instru Care oleo para instrumentos 635
 instrumento para circuncision 556
 instrumento para circuncision Mogen 556
 instrumento para cuerpo extraños Dix 380
 instrumento para cuerpo extraños LaForce 374
 instrumento para el fragmento de la uña 612/1
 instrumento para uña Ingrown 612/1
 instrumento para varices Varady 202
 instrumento para vendaje enyesado Reda 232
 instrumentos para manicura 612, 612/1
 instrumentos para medir 594
 instrumentos para tracheotomia 475
 Iowa pinza uterina 584
 Iris tijera para cirugía 54/2
 Iris tijera supercut 72
 Israel separador 162
 Iterson gancho para traqueotomia 477
 Ives-Fansler anoscopio 562
 Iwanson calibrador decimal 227

J

Jackson especulo vaginal 573
 Jackson gancho para traqueotomia 476
 Jackson pinza de agarre para tendones 292
 Jackson pinza para tapones 471
 Jackson separador traqueal 476
 Jackson-Burrows separador 189/2
 Jackson-Chevalier canula para traqueotomia 479
 Jackson-Chevalier pinza para bronco-esofagoscopia 473
 Jacobs pinza uterina 583
 Jacobsen porta aguja 215
 Jacobson cucharilla cortante 257
 Jacobson sonda abotonada 335
 Jaeger cuchillo de discision 372
 Jaeger placa para parpado 371
 Jameson gancho para estrabismo 375
 Jameson pinza para estrabismo 385
 Jansen cucharilla cortante 257
 Jansen pinza gubia 237
 Jansen pinza nasal 424
 Jansen separador 168
 Jansen-Doyen (Molt) abre-boca 454
 Jansen-Gruenwald pinza nasal 424
 Jansen-Middleton pinza para el tabique nasal 430
 Jansen-Zaufal elevador auricular 409
 Jansen-Zaufal pinza gubia 238
 Jarcho pinza uterina 583
 Javid pinza para shunt carotido 511
 Jennings abre-boca 454
 Jensen canula capsular 394
 jeringa 406, 407, 470
 jeringa auricular Reiner 407
 jeringa para amígdalas 470
 Jobson-Horne porta-algodon 203
 Johns-Hopkins pinza hemostatica 120
 Johns-Hopkins serra-fina 104
 Joll especulo vaginal 477, 577
 Joll separador 477, 577
 Jones pinza de campo 132
 Jones-Clip pinza de campo 132
 Jones-Leland pinza para vasos perifericos 495
 Jonson porta aguja 211
 Jorgensen tijera de diseccion 53
 Joseph (Lewis) lima nasal 443

Joseph bisturi nasal 434, 435
 Joseph Cottle elevador para el tabique nasal 439
 Joseph elevador para el tabique nasal 437
 Joseph ganchito 149
 Joseph lima para hueso 443
 Joseph Peck tijera face lift 73
 Joseph periostotomo 277
 Joseph sierra nasal 446
 Joseph tijera para cirugía 54/1
 Judd-Allis pinza intestinal 538
 Judd-Masson separador vesical 552
 juego de laringoscopia McIntosh 29/1-30/1
 juego de manicura para enfermeras 609
 juego de intercambio para alicata Hercules 320/1-320/3
 juego para varices Nabatoff 201
 Juers pinza auricular micro 414
 Jurasz pinza para polipos laringeos 471

K

Kader espátula abdominal 143/3
 Kallmorgen especulo vaginal 573
 Kalt pinza capsular 391
 Kalt porta aguja 214
 Kalt-Arruga porta aguja 214
 Kane clamp umbilical 605
 Kantowitz pinza hemostatica 119/1
 Kaye tijera face lift 73
 Kay-Lambert pinza para anastomosis 505
 Kazanjian-Cottle pinza cortante para huesos 241
 Kelly Grip separador 142
 Kelly pinza hemostatica 106
 Kelly pinza para polipos uterinos 585
 Kelly protoscopio 562, 563
 Kelly separador 142, 164
 Kelly tijera vascular 61
 Kevorkian pinza para polipos 106
 Kern pinza para hueso 244
 Kerrison pinza cortante 428
 Kerrison-Ferris-Smith pinza sacabocado para discos intervertebral 344, 344/2
 Kevorkian cureta para biopsia 587
 Kevorkian pinza para biopsia 589, 591
 Kevorkian-Pacific pinza para biopsia 592
 Kevorkian-Tischler pinza para biopsia 592
 Key elevador 282
 Keyes trepano 608
 Kielland forceps obstetrico 602
 Kielland-Luikart forceps obstetrico 603
 Killian (Eicken) canula irrigacion 433
 Killian canula 433/1
 Killian cincel nasal 442/1
 Killian elevador para el tabique nasal 438, 439
 Killian especulo nasal 423
 Killian tijera para septo 471
 Killian-Claus cincel nasal 442/1
 Kilner gancho cutaneo 608
 Kilner porta aguja 212
 Kilner retractor nasal 447/1
 Kilner tijera para cirugía 54/1
 Kilner/Ragnell tijera supercut 72
 Kilner-Doughty abre-boca 456
 Kirby-Arthur pinza para fijacion 385
 Kirk martillo 270
 Kirschner alambre 306, 307
 Kirschner estribo para extension 312
 Kirschner gancho 313
 Kirschner separador abdominal 187, 187/1
 Kirschner sonda conductora 221
 Kirschner soporte de esterilizacion para alambres 305
 Kirschner U.S. estribo para extension 312
 Klapp gancho 150
 Kleiner-Kutz ganchito 149
 Kleiner-Kutz pinza de agarre para tendones 294

Kleiner-Kutz pinza gubia 237
 Kleinsasser anillo 36
 Kleinsasser articulacion 36
 Kleinsasser canula de inyeccion 36
 Kleinsasser canula de succion 36
 Kleinsasser laringoscopia operativo 35
 Kleinsasser portador de luz fria 36
 Kleinsasser soporte pectoral 36
 Klinikum Berlin pinza cierra-tubo 129
 Klinkenbergh-Loth tijera vasija 65/2
 Knapp cucharilla para cataratas 378
 Knapp gancho 375
 Knapp tijera para cirugía 55
 Knapp-Luer pinza para tracomia 393
 Knight pinza nasal 425
 Knight-Heymann pinza nasal 425
 Knowles tijera para vendaje 70
 Kocher espátula vesical 552
 Kocher pinza hemostatica 108
 Kocher pinza intestinal 540
 Kocher separador 155, 159, 160, 163
 Kocher sonda para bocio 479
 Kocher-Langenbeck separador 159
 Koenig sonda conductora 221/1
 Koenig-Roser abre-boca 454
 Koerte separador 162
 Koerte-Luer cuchara para calculos biliares 533
 Kofler-Hajek pinza cortante 429
 Kofler-Hajek pinza sacabocado 431
 Kogan especulo endocervical 577
 König elevador 284
 König periostotomo 276
 König separador 153
 Koos micro cuchillo 335
 Körte separador 143/3
 Krause cierra-nudo auricular 411
 Krause polipotomo 433/2
 Krause punta de pinza 472
 Krause-Voss polipotomo 433/2
 Krayenbühl gancho para nervios 336
 Kristeller especulo vaginal 572
 Kroenig baja-lengua 451
 Kronecker aguja para ligadura 219
 Kuentscher impactor final 321
 Kuglen manipulador 376
 Kümmel espátula abdominal 143/4, 144
 Kümmel separador abdominal 143/4
 Küntscher extractor 322
 Küntscher perforador para femur 321
 Küntscher perforador para la cavidad medular 321
 Kutz-Kleiner ganchito 149
 Kutz-Kleiner pinza de agarre para tendones 294
 Kutz-Kleiner pinza gubia 237

L

Laborde dilatador traqueal 476
 Lacrimal canula 394
 LaForce adenotomo 450
 LaForce instrumento para cuerpos extraños 374
 LaGrange tijera para encias 69
 Lahey ganchito 149
 Lahey Ganchos en forma de silla 149
 Lahey pinza hemostatica 119/2, 120
 Lahey pinza para agarrar el bocio 479
 Lahey separador 157
 Lambert pinza para chalazion 393
 Lambert-Kay pinza para anastomosis 505
 Lambert-Lowman pinza para huesos 249
 Lambotte Elevadores para huesos 287
 Lambotte osteotomo 261
 Lambotte periostotomo 274
 Lambotte pinza para hueso 244
 Lambotte-Farabeuf pinza para hueso 243

lampara frontal Clar.....	22	lima para huesos.....	294, 443-446, 612/1	mango de acople rapido.....	301
lampara halogena.....	29	lima para huesos Putti.....	294	mango de aspiracion Wullstein.....	338
Lancaster blefarostato.....	371	lima para seno Gallaher.....	446	mango de bisturi Collin.....	40
Landau especulo vaginal.....	577	Lister (Sinus) pinza porta esponja.....	137	mango de pila para laringoscopia.....	32-34
Landau-Segond pinza para histerectomia.....	125	Lister tijera para vendaje.....	69/1	mango para cincel/gubia.....	266
Lane destornillador.....	323, 324	Lister tijera supercut.....	72	mango para espejo laringeo.....	473
Lane elevador.....	290	listón.....	228	mango para sierra hilo Gigli.....	332
Lane palanca para doblar placas.....	325	Liston cuchillo para amputacion.....	44	mango universal Huber.....	472
Lane pinza de campo.....	133	Liston pinza cortante para huesos.....	241	Mangos de bisturios.....	38-41
Lane pinza de diseccion.....	84	Liston-Ruskin pinza cortante para huesos.....	241	Mangos de bisturios BARRON.....	38
Lane pinza estomacal.....	548	Liston-Stille pinza cortante para huesos.....	242	Mangos de laringoscopia.....	31-32, 34
Lane pinza para hueso.....	244	Littauer pinza auricular.....	411	manguito de cierre Stone-Watt.....	545
Lane pinza para sostener placas.....	325	Littauer pinza depilatoria.....	395	manguito de cierre Watt-Stone.....	545
Lane pinza para sostener tornillos.....	325	Littauer pinza para polipos.....	425	manipulador Kuglen.....	376
Lane Trethowan elevador.....	290	Littauer tijera para ligadura.....	66	MANNERFELT Retractor con	
Lane-Murphy elevador.....	283	Little separador.....	157	mango triangular.....	148/3, 148/4, 148/5
Lang disecador para el saco lacrimal.....	378	Littler tijera para cirugia.....	55	manometro.....	295
Lange gancho para las alas de la nariz.....	448	Littlewood pinza intestinal.....	538	manopla de plomo.....	250
Lange punta de pinza.....	472	llave de tuerca.....	313	marcador Amstler-Connin.....	380
Lange-Hohmann elevador.....	286	Locke espátula.....	612/1	Marquardt pinza gubia.....	239
Langenbeck asa.....	409	Lockhart-Mummary sonda para fistula.....	200	Marschik pinza para amigdalas.....	468
Langenbeck cuchillo para amputacion.....	44	Locklin tijera para encias.....	69	Martel pinza hemostatica.....	110
Langenbeck cuchillo para reseccion.....	47	Lockwood-Allis pinza intestinal.....	53	Martel Willet pinza hemostatica.....	110
Langenbeck periostotomo.....	275	Lokite Collin separador abdominal.....	191	martillo.....	24, 270-273
Langenbeck pinza para hueso.....	243	London-College pinza dental.....	93	martillo Bergmann.....	272
Langenbeck porta aguja.....	213	Lopez-Reinke elevador para amigdales.....	465	martillo Collin.....	270
Langenbeck separador.....	158, 159	Lorenz tijera para vendaje.....	70	martillo Cottle.....	273
Langenbeck sierra para amputacion.....	296	Lorna pinza para campo.....	133	martillo de percusion Babinsky.....	24
Langenbeck-Green separador.....	153	Loth-Klinkenbergh tijera vasiija.....	65/2	martillo de percusion Berliner.....	24
Langenbeck-Kocher separador.....	159	Loute tensor de cierra-hilo.....	315	martillo de percusion Buck.....	24
LANGENBECK-MANNERFELT Retractor		Love separador para la raiz de nervios.....	329/2, 330	martillo de percusion Taylor.....	24
con mango triangular.....	148/4	Love separador para uvula.....	465	martillo de percusion Troemner.....	24
Langenbeck-Parker / Us Army separador.....	141	Love-Gruenwald pinza cortante para laminectomia.....	340	martillo Gerzog.....	270
laringoscopia McIntosh.....	29/1-30/1	Lovelace pinza hemostatica.....	109	martillo Hajek.....	273
laringoscopia Miller.....	29/3, 30/3	Lovelace pinza para coger el pulmon.....	490	martillo Heath.....	273
laringoscopia operativo Kleinsasser.....	35	Lower pinza hemostatica.....	120	martillo Kirik.....	270
Larsen pinza para tendones.....	292	Lowman pinza para huesos.....	249	martillo Lucae.....	271
Lawrence pinza hemostatica.....	119	Lowman-Hoglund pinza para huesos.....	249	martillo Mead.....	271
Lebsche cincel de estemon.....	267	Lowman-Lambert pinza para huesos.....	249	martillo Ombredanne.....	273
Lees pinza bronquial.....	504	Lubet-Barbon pinza nasal.....	424	martillo Partsch.....	271
legra de succion Guilen.....	433/1	Luc pinza nasal.....	426	martillo Quising.....	271
Legueu espátula vesical.....	552	Lucae aguja para paracentesis.....	408	martillo Williger.....	271
Leksell (Stille) pinza gubia.....	240	Lucae diapason.....	404	Martillos DOYEN.....	271
Leland-Jones pinza para vasos perifericos.....	495	Lucae gancho abotonado.....	409	Martin histerometro.....	586
Lempert cucharilla cortante.....	256	Lucae martillo.....	271	Martin pelvimetro.....	605
Lempert pinza gubia.....	237	Lucae pinza auricular.....	410	Martin pinza para cartilago.....	246
Lerche pinza de diseccion.....	83	Luer canula para traqueotomia.....	479	Martin separador.....	175/1
Lerliche pinza hemostatica.....	111	Luer pinza gubia.....	236	Martin-Cartilago tijera.....	65/1
Leriche separador intestinal.....	143/4	Luer separador.....	140	Martini cucharilla cortante.....	257
Lester pinza para fijacion.....	389	Luer-Knapp pinza para tracomia.....	393	Masing elevador.....	437
Lewin pinza para hueso.....	246	Luer-Koerte cuchara para calculos biliares.....	533	Masing elevador para tabique nasal.....	437
Lewis (Joseph) lima nasal.....	443	Luer-Stille pinza gubia.....	239	Masing retractor nasal.....	447
LEWY Soporte pectoral.....	37	Luikart forceps obstetrico.....	603	Masing-Neivert retractor nasal.....	447
Lexer Baby tijera de diseccion.....	53	Luikart-Bill tractor.....	604	Masson porta aguja.....	210
Lexer gubia.....	263	Luikart-Kielland forceps obstetrico.....	603	Masson-Judd separador vesical.....	552
Lexer Mini gubia.....	263	Luikart-McLean-Tucker forceps obstetrico.....	603/1	Massin pinza muscular.....	479
Lexer Mini osteotomo.....	263	Lundsgaard esclerotomo.....	373	Mathieu especulo rectal.....	560
Lexer osteotomo.....	263	Lundsgaard-Guyton esclerotomo.....	373	Mathieu pinza para cuerpos extraños.....	553/1
Lexer tijera de diseccion.....	53	Luniatschek tamponeador.....	465	Mathieu porta aguja.....	213
Leyla separador de sistema.....	368-368/3			Mathieu separador.....	141
lezna Obwegeser.....	463, 463/3			Mathieu-Olsen porta aguja.....	212
Lichtwitz trocar para seno maxilar.....	204			Matson periostotomo.....	279
Liebermann blerarostato.....	371			Matson-Alexander periostotomo.....	279
ligador para hemorroides.....	568			Maudner garrote de madera.....	459
ligador para hemorroides McGivney.....	568			Maxi Grasper pinza para biopsia.....	593
ligador para hemorroides Rudd.....	568			May oftalmoscopio Uni II.....	14
lima nasal Aufricht.....	443			Mayfield pinza gubia.....	238
lima nasal Cottle (Maltz).....	444			Mayo baja-lengua.....	451
lima nasal Fomon.....	444, 445			Mayo clip para esterilizacion.....	227
lima nasal Joseph (Lewis).....	443			Mayo cuchara para calculos biliares.....	534
lima nasal Lewis (Joseph).....	443			Mayo pinza de diseccion.....	89
lima nasal Maltz.....	443, 444			Mayo sonda para calculos biliares.....	534
lima nasal Maltz (Cottle).....	444			Mayo tijera de diseccion.....	52/1
lima para hueso Joseph.....	443			Mayo tijera supercut.....	71

M

Magauran adenoidectomia - tonsilectomia.....	459
Magill pinza para introducir cateter.....	28
Maier-Gross pinza porta-esponja.....	134
Maingot pinza para histerectomia.....	123/1, 123/2
Maltz (Cottle) lima nasal.....	444
Maltz lima nasal.....	443, 444
mamaria, separador.....	487/1
mandril.....	299
mandril para cateter Guyon.....	554
mango bisturi Mini.....	41
mango bisturios.....	38-41
Mango con iluminacion para MORGAN.....	565

Mayo-Adams separador.....	171
Mayo-Blake pinza para calculos biliares.....	530/2
Mayo-Collins separador.....	141
Mayo-Guyon pinza hemostatica.....	122
Mayo-Haberisser pinza para torcer hilo.....	319
Mayo-Hegar porta aguja.....	209
Mayo-Noble tijera de diseccion.....	52/1
Mayo-Robson pinza intestinal.....	541
Mayo-Stille tijera de diseccion.....	52/1
Mayo-Stille tijera supercut.....	71
MC KENZIE taladro.....	298
McCullough pinza para estrabismo.....	385
McDonald elevador.....	283
McGee gancho.....	419
McGee pinza auricular micro.....	414
McGivney ligador para hemorroides.....	568
McGivney pinza para hemorroides.....	568
McIndoe pinza cortante para huesos.....	241
McIndoe pinza de diseccion.....	85
McIndoe tijera para cartilago.....	65/1
McIntosh juego de laringoscopio.....	29/1-30/1
McIntosh laringoscopio.....	29
McINTOSH Laryngoskope.....	29/1, 30/1
McINTOSH Laryngoskope Establece.....	29-30
McIntyre canula lacrimal.....	394
McIvor abre-boca.....	457
McKenty elevador para el tabique nasal.....	437, 438
McKenzie pinza aplicadora.....	326
McKESSON Cuadro metalico.....	454/1
McLean forceps obstetrico.....	603/1
McLean-Luikart forceps obstetricos.....	603/1
McLean-Tucker-Luikart forceps obstetrico.....	603/1
McPherson pinza para ligadura.....	392
Mead martillo.....	271
Mead pinza gubia.....	235
Meeker pinza hemostatica.....	119
Mehdom pinza para vasos.....	362
Mellinger blefarostato.....	370
Menghini aguja para biopsia.....	206
meniscomoto Neff.....	292
meniscomoto Smillie.....	292
Meriam pinza dental.....	93
Metzenbaum porta aguja.....	211
Metzenbaum tijera de diseccion.....	53/1
Metzenbaum tijera para cirugia.....	54
Metzenbaum tijera supercut.....	71
METZENBAUM Tijeras de diseccion.....	53/3, 53/4
Meyer pinza para huesos.....	248
Meyer-Davis abre-boca.....	457
Meyerdinger separador.....	157, 177, 180
Meyhoefer cucharilla para chalazion.....	377
Michel agrafe.....	224
Michel espejo laringeo.....	423
Michel pinza para aplicar y quitar agrafes.....	224
micro cuchillo Koons.....	335
micro Friedmann pinza gubia.....	234
micro pinza.....	86, 94
micro pinza auricular.....	413-415
micro porta aguja Barraquer.....	216, 217
micro porta aguja Barraquer-Troutman.....	216
micro porta aguja Castroviejo-Standard.....	216
micro porta aguja Standard-Castroviejo.....	216
micro porta aguja Troutman-Barraquer.....	216
micro tijera.....	76-78
micro tijera Circumflex.....	76
micro tijera Gomel.....	80
micro tijera Hepp-Scheidel.....	78
micro tijera Reda.....	77, 80
micro tijera Scheidel-Hepp.....	78
Micro-Castroviejo porta aguja.....	215
Microvascular porta aguja.....	210
Middeldorf separador.....	160
Middleton-Jansen pinza para el tabique nasal.....	430
Mikulicz pinza intestinal.....	543

Mikulicz pinza para peritoneo.....	123
Mikulicz separador.....	163
Miller laringoscopio.....	29/3, 30/3
MILLER Laryngoskope.....	29/3, 30/3
MILLER Laryngoskope Establece.....	29/2, 30/2
Miller-Senn separador.....	143
Milligan elevador para duramadre.....	332
Millin pinza de agarre para capsula.....	550, 551
Millin pinza para ligadura.....	551
Millin pinza para lobo anterior.....	551
Millin separador cuello vejiga.....	553
Millin separador vesical.....	552
Mini Friedmann pinza gubia.....	234
Mini Hohmann elevador.....	286
Mini mango de bisturi.....	41
Mini Roux separador.....	140
Mini-Lambotte osteotomo.....	262
Minimus III esfigmomanometro.....	12
Mini-Townsend-Down pinza para biopsia.....	591
Mini-Townsend-Up pinza para biopsia.....	591
Minnesota-Cawood baja-lengua.....	451
Mixer Baby pinza hemostatica.....	119/1
Mixer pinza hemostatica.....	116, 119/1-120
Mixer pinza para calculos biliares.....	530/2, 531
Mixer-DeBaKey pinza para ligaduras.....	499/2
Mixer-O'Shaughnessy pinza hemostatica.....	119/2
Mixer-Overholt pinza hemostatica.....	115
Mod. Bonn pinza para sutura.....	386
Mod. Muenchen cureta para biopsia.....	587
Mod. Tübingen pinza para ligadura.....	392
Mod. Tübingen pinza para sutura.....	386
Mod. USA tijera para cordon umbilical.....	64
Mod. Vienna especulo nasal.....	421
Moeltgen goniometro.....	25
Mogen instrumento para circuncision.....	556
Mollison separador.....	171
Molt (Doyen-Jansen) abre-boca.....	454
Molt periostotomo.....	276
mondador de tendones Brand.....	294
monopolares pinza.....	634
Moore-Stauda pinza uterina.....	582
Moorfield pinza para sutura.....	392
More-Vu especulo vaginal.....	569
MORGAN Proctoscopios.....	565
Morgan-Tischler pinza para biopsia.....	590, 591
Moritz-Schmidt baja-lengua.....	452
Morris separador.....	164
Morris-DeBaKey pinza para la aorta.....	506
Morse separador costal.....	484
Morse-Favaloro separador costal.....	484
Mosher-Wagener canula para traqueotomia.....	474
Mosquito-DeBaKey pinza hemostatica.....	509
Mosquito-Halsted pinza hemostatica.....	105
Moynihan explorador apra calculos biliares.....	531
Moynihan pinza hemostatica.....	120
Mueller blearostato.....	371
Muenchen Mod. cureta para biopsia.....	587
Müller aproximador.....	364
Müller clip para vasos.....	365
Müller-Verbrugge elevador.....	286/2
Mummery-Lockhart sonda para fistula.....	200
Murdoch blefarostato.....	370
Murphy-Lane elevador.....	283
Murray-Crile porta aguja.....	209
Museux pinza uterina.....	583
Myles pinza nasal.....	427

N	
Nabatoff juego para varices.....	201
Naegele forceps obstetrico.....	603
Nager aguja para sutura del paladar.....	466
Nager separador para paladar.....	465
Nasalis-Spina separador para el ramo.....	461

navaja.....	49
Neff meniscomoto.....	292
Negus pinza para coger amigdalas.....	467
Negus soporte de pecho.....	459
Neivert porta aguja.....	208
Neivert-Anderson cincel nasal.....	442
Neivert-Cottle gancho para la piel.....	448
Neivert-Masing retractor nasal.....	447
Nelaton sonda.....	199
Nelson (Standard) trocar abdominal.....	204
Nelson pinza de diseccion.....	89
Nelson trocar.....	205
Neonatal pinza vascular.....	523
News gancho para traqueotomia.....	477
Nissen pinza hemostatica.....	113
Noble-Mayo tijera de diseccion.....	52/1
Norfolk / Norwich separador.....	172
Northbent tijera.....	66
Norwich / Norfolk separador.....	172
Noto pinza para polpos uterinos.....	585
Nova esfigmomanometro.....	7
Novak cureta aspiradora para biopsia uterina.....	587
Nova-Presameter esfigmomanometro.....	6
Noyes pinza para polpos.....	425
Noyes tijera para iris.....	75

O	
Obwegeser elevador.....	461/1
Obwegeser gancho de menton.....	461/1
Obwegeser lezna.....	463, 463/3
Obwegeser osteotomo.....	463
Obwegeser osteotomo de hoja.....	464/1
Obwegeser periostotomo.....	462
Obwegeser separador mandibular.....	461/1
Obwegeser separador para partes blandas.....	460
OCHSNER Exploradores para calculos biliares.....	531
Ochsner pinza de diseccion.....	88
Ochsner trocar.....	205
Ochsner-Rochester pinza hemostatica.....	108
O'Connor gancho para iris.....	375
O'Connor-O'Sullivan especulo vaginal.....	576
O'Connor-O'Sullivan separador abdominal.....	181
Oehler pinza de diseccion.....	81/1
oftalmoscopio May II.....	14
Oldberg pinza cortante para laminectomia.....	341/1
Olivecrona elevador para duramadre.....	332
Olivecrona espátula cerebral.....	336
Olivecrona pinza gubia.....	237
Olivecrona sierra hilo.....	332
Olivecrona-Toennis pinza aplicadora.....	326
Ollier separador.....	162
Olsen-Hegar porta aguja.....	212
Olsen-Mathieu porta aguja.....	212
Ombredanne (Jackson) Pinzas de campos.....	133
Ombredanne martillo.....	273
Ombredanne Punzón.....	304
O'Shaughnessy-Mixer pinza hemostatica.....	119/2
osteotomo.....	259-267, 464
osteotomo de hoja Obwegeser.....	464/1
osteotomo Epker.....	464/2
osteotomo Hibbs.....	265
osteotomo Hoke.....	265
osteotomo Lambotte.....	261
osteotomo Lambotte-Mini.....	262
osteotomo Lexer.....	263
osteotomo Lexer Mini.....	263
osteotomo Mini Lexer.....	263
osteotomo Mini-Lambotte.....	262
osteotomo Obwegeser.....	463
osteotomo Stille.....	260
Ostroem pinza sacabocado.....	430
O'Sullivan-O'Connor especulo vaginal.....	576
O'Sullivan-O'Connor separador abdominal.....	181

Otis bujias dilatadoras.....	554
Otis uretrotomo.....	553
otoscopio Uni I.....	13
Overholt pinza hemostatica.....	114
Overholt-Baby pinza hemostatica.....	114
Overholt-Geissendoerfer pinza hemostatica.....	114
Overholt-Mixer pinza hemostatica.....	115

P

Pacific-Kevorkian pinza para biopsia.....	592	periotostomo Molt.....	276	pinza circular.....	432
palanca para doblar placas Lane.....	325	periotostomo Obwegeser.....	462	pinza cortante Hajek-Kofer.....	429
Palmer-Pozzi pinza uterina.....	582	periotostomo Quervain.....	275	pinza cortante Kerrison.....	428
Park blearastato.....	371	periotostomo Sebleau.....	275	pinza cortante Kofer-Hajek.....	429
Parker separador.....	139	periotostomo Sedillot.....	274, 275	pinza cortante para hipofisis.....	341
Parker-Langenbeck / Us Army separador.....	141	periotostomo Seldin.....	277	pinza cortante para huesos Böhler.....	241
Partsch cincel.....	259	periotostomo Semb.....	278	pinza cortante para huesos Cottle-Kazanjan.....	241
Partsch gubia.....	259	periotostomo Williger.....	276	pinza cortante para huesos Horsley-Stille.....	242
Partsch martillo.....	271	Perkins separador.....	168	pinza cortante para huesos Kazanjan-Cottle.....	241
pasador de tendones Bunell.....	294	Perthes escariador.....	304	pinza cortante para huesos Liston.....	241
Passow cincel tamponador para huesos.....	260	Pestalozza cureta para aborto.....	606	pinza cortante para huesos Liston-Ruskin.....	241
Patella pinza para hueso.....	248	Petersen-Smith cincel.....	261	pinza cortante para huesos Liston-Stille.....	242
Paton disecador corneal.....	373	Petersen-Smith gubia.....	261	pinza cortante para huesos McIndoe.....	241
Paufique cuchillo para queratoplastica.....	373	Petersen-Smith pinza gubia.....	238	pinza cortante para huesos Ruskin-Liston.....	241
Paufique pinza para ligadura.....	392	Petri cubeta.....	620	pinza cortante para huesos Semb.....	242
Payr pinza intestinal y estomacal.....	549	Phaneuf pinza para peritoneo.....	123	pinza cortante para huesos Stamm.....	241
Payr sonda conductora.....	221/1	Pierce elevador para el tabique nasal.....	438	pinza cortante para huesos Stille-Horsley.....	242
Payr-Baby pinza intestinal y estomacal.....	549	Pierce trocar para seno maxilar.....	204	pinza cortante para huesos Stille-Liston.....	242
Payr-Schmieden sonda conductora.....	221	Pieza alargadera.....	298	pinza cortante para laminectomia Cloward.....	342
Peaen pinza hemostatica.....	108, 110	pieza de acomplamiento para cureta aspiradoras.....	600	pinza cortante para laminectomia Cushing.....	340
Peaen-DeBaKey pinza hemostatica atraumatica.....	513	Piffard cureta para lupus.....	608	pinza cortante para laminectomia Decker.....	341
Peaen-Rochester pinza hemostatica.....	108	Pinard estetoscopio.....	23	pinza cortante para laminectomia Ferris-Smith.....	343
Peapod pinza cortante para laminectomia.....	341/1	pinza aplicadora.....	104	pinza cortante para laminectomia Gruenwald-Love.....	340
Peck Joseph tijera face lift.....	73	pinza aplicadora de clips.....	524, 525	pinza cortante para laminectomia Love-Gruenwald.....	340
Pederson espejulo vaginal.....	570	pinza aplicadora McKenzie.....	326	pinza cortante para laminectomia Oldberg.....	341/1
Peers pinza de campo.....	132	pinza aplicadora Olivecrona-Toennis.....	326	pinza cortante para laminectomia Peapod.....	341/1
Peet escofina nasal.....	446	pinza aplicadora Raney.....	327	pinza cortante para laminectomia Schlesinger.....	342
Peet pinza para espinas.....	92	pinza aplicadora Smithwick.....	326	pinza cortante para laminectomia Smith-Ferris.....	343
Pelkmann pinza porta esponja.....	137	pinza aplicadora Toennis-Olivecrona.....	326	pinza cortante para laminectomia Spurling.....	340
pelvimetro Collier.....	605	pinza atraumatica Cooley.....	99	pinza cortante para laminectomia Wagner.....	343
pelvimetro Collin.....	605	pinza atraumatica DeBaKey.....	98, 99	pinza cuticular.....	610
pelvimetro Martin.....	605	pinza atraumatica Gregory.....	517	pinza de agarre.....	305
Pemberton-Harrington separador.....	147	pinza atraumatica Reda.....	111	pinza de agarre para capsula Millin.....	292-294, 550, 551
Penfield elevador para duramadre.....	333	pinza atraumatica Rogers.....	127	pinza de agarre para prostata Young.....	550
Pennington elevador para el tabique nasal.....	438	pinza auricular Harken.....	503	pinza de agarre para tendones.....	292, 293
Pennington pinza hemostatica.....	109	pinza auricular Hartmann.....	411	pinza de agarre para tendones Brand.....	293
Percy retractor para amputacion.....	296	pinza auricular Littauer.....	411	pinza de agarre para tendones Caroll.....	293
perforacraqueo Smellie.....	607	pinza auricular Lucae.....	410	pinza de agarre para tendones Jackson.....	292
perforador de mano.....	300, 304	pinza auricular micro.....	413-415	pinza de agarre para tendones Kleiner-Kutz.....	294
perforador de mano Bunell.....	299	pinza auricular micro Cos.....	414	pinza de agarre para tendones Kutz-Kleiner.....	294
perforador de mano Hudson.....	298	pinza auricular micro Dieter.....	414	pinza de agarre para tendones Steinmann.....	292
perforador de mano Ralk.....	299	pinza auricular micro Grevén.....	414	pinza de aplicacion.....	357-360
perforador de mano Reda.....	299	pinza auricular micro Haugh.....	414	pinza de campo.....	132, 133
perforador inicial Crutchfield.....	327	pinza auricular micro Juers.....	414	pinza de campo Backhaus.....	132
perforador medular.....	322	pinza auricular micro McGee.....	414	pinza de campo Backhaus-Clip.....	132
perforador para femur Küntscher.....	321	pinza auricular micro Wullstein.....	416	pinza de campo Bernhard.....	133
perforador para la cavidad medular Küntscher.....	321	pinza auricular Tilley.....	411	pinza de campo Clip-Backhaus.....	132
periotostomo.....	274-280, 463-464	pinza auricular Troeltsch (Wilde).....	410	pinza de campo Clip-Jones.....	132
periotostomo Alexander.....	276	pinza auricular Wilde (Troeltsch).....	410	pinza de campo Doyen.....	133
periotostomo Alexander-Matson.....	279	pinza autocentradora para sostener huesos Reda.....	247	pinza de campo Jones.....	132
periotostomo Cobb.....	280	pinza bronquial.....	126	pinza de campo Jones-Clip.....	132
periotostomo Collin-Farabeuf.....	274	pinza bronquial Finochietto.....	490	pinza de campo Lane.....	133
periotostomo Dingman.....	463	pinza bronquial Harrington.....	490	pinza de campo Peers.....	132
periotostomo Doyen.....	278	pinza bronquial Lees.....	504	pinza de campo Roeder.....	132
periotostomo Farabeuf.....	274	pinza bronquial Price-Thomas.....	490	pinza de campo Schaedel.....	132
periotostomo Farabeuf-Collin.....	274	pinza bronquial Semb.....	491	pinza de campo Tohuku.....	132
periotostomo Fomon.....	277	pinza bronquial Thomas-Price.....	490	pinza de diseccion.....	81-89
periotostomo Hargis.....	463/2	pinza capsular Arruga.....	391	pinza de diseccion Adlerkreutz.....	84
periotostomo Joseph.....	277	pinza capsular Arruga-Gill.....	390	pinza de diseccion Adson.....	81/2, 82
periotostomo König.....	276	pinza capsular Castroviejo.....	391	pinza de diseccion Adson-Brown.....	82
periotostomo Lambotte.....	274	pinza capsular Elschnig.....	391	pinza de diseccion Adson-DeBaKey.....	81/2
periotostomo Langenbeck.....	275	pinza capsular Fuchs.....	391	pinza de diseccion Barraya-Stille.....	88
periotostomo Matson.....	279	pinza capsular Gill-Arruga.....	390	pinza de diseccion Bonney.....	88
periotostomo Matson-Alexander.....	279	pinza capsular Hess.....	391	pinza de diseccion Brophy.....	84
		pinza capsular Kalt.....	391	pinza de diseccion Brown.....	83
		pinza capsular Schweigger.....	391	pinza de diseccion Brown-Adson.....	82
		pinza capsular Terson.....	391	pinza de diseccion Collin-Duval.....	85
		pinza cierra-tubo.....	129, 130	pinza de diseccion Cushing.....	83
		pinza cierra-tubo Berlin Klinikum.....	129	pinza de diseccion Cushing-Taylor.....	87
		pinza cierra-tubo Bülow-Gunar-Hey.....	130	pinza de diseccion DeBaKey-Adson.....	81/2
		pinza cierra-tubo Gunar-Hey-Bülow.....	130	pinza de diseccion Duetshren.....	84
		pinza cierra-tubo Hey-Bülow-Gunar.....	130	pinza de diseccion Durante.....	88
		pinza cierra-tubo Klinikum Berlin.....	129	pinza de diseccion Duval.....	85
		pinza cierra-tubo Presbyterian.....	129	pinza de diseccion Duval-Collin.....	85

pinza de diseccion Ferris-Smith	85	pinza gubia Stellbrink	234	pinza hemostatica Pennington	109
pinza de diseccion Gerald	86, 87	pinza gubia Stille (Leksell)	240	pinza hemostatica Pratt	110
pinza de diseccion Gillies	86	pinza gubia Stille-Luer	239	pinza hemostatica Providence-Hospital	106
pinza de diseccion Graefe	83	pinza gubia Stille-Ruskin	239	pinza hemostatica Rankin-Crile	107
pinza de diseccion Lane	84	pinza gubia Zaufal-Jansen	238	pinza hemostatica Rankin-Kelly	106
pinza de diseccion Lerche	83	pinza hemorroidal Heywood-Smith	567	pinza hemostatica Roberts	117
pinza de diseccion Mayo	89	pinza hemorroidal Smith-Heywood	567	pinza hemostatica Rochester-Carmalt	109
pinza de diseccion McIndoe	85	pinza hemostatica Adson	112, 113	pinza hemostatica Rochester-Ochsner	108
pinza de diseccion modelo ruso	85	pinza hemostatica Adson Baby	113	pinza hemostatica Rochester-Pean	108
pinza de diseccion modelo Strassburger	89	pinza hemostatica atraumatica DeBaKey-Mosquito	509	pinza hemostatica Rumel	117
pinza de diseccion Nelson	89	pinza hemostatica atraumatica DeBaKey-Pean	513	pinza hemostatica Sarot	118
pinza de diseccion Ochsner	88	pinza hemostatica atraumatica DeBaKey-Rankin	512	pinza hemostatica Sellors-Crafoord	119
pinza de diseccion Oehler	81/1	pinza hemostatica atraumatica Mosquito-DeBaKey	509	pinza hemostatica Spencer-Wells	109
pinza de diseccion Potts-Smith	81, 81/1	pinza hemostatica atraumatica Pean-DeBaKey	513	pinza hemostatica Stille	122
pinza de diseccion Semken	86	pinza hemostatica atraumatica Rankin-DeBaKey	512	pinza hemostatica Toennis	117
pinza de diseccion Singley	88	pinza hemostatica Baby Adson	113	pinza hemostatica Tuffer	110
pinza de diseccion Smith-Ferris	85	pinza hemostatica Baby Mixer	119/1	pinza hemostatica Wells-Spencer	109
pinza de diseccion Smith-Potts	81, 81/1	pinza hemostatica Baby-Overholt	114	pinza hemostatica Wikstrom	117
pinza de diseccion Standard	81, 81/1	pinza hemostatica Bainbridge	119/2	pinza hemostatica Willet Martel	110
pinza de diseccion Stille	81, 81/1	pinza hemostatica Bengolea	112	pinza hemostatica Zenker	118
pinza de diseccion Stille-Barraya	88	pinza hemostatica Birkelt	116	pinza intestinal Adair-Allis	537
pinza de diseccion Taylor	87	pinza hemostatica Bridge	116	pinza intestinal Allis	537
pinza de diseccion Taylor-Cushing	87	pinza hemostatica Carmalt-Rochester	109	pinza intestinal Allis-Adair	537
pinza de diseccion USA	81, 81/1	pinza hemostatica Chaput	110	pinza intestinal Allis-Baby	537
pinza de diseccion Wagensteen	89	pinza hemostatica Coller-Crile	106	pinza intestinal Allis-Boys	538
pinza de diseccion Waugh	83	pinza hemostatica Collin	110	pinza intestinal Allis-Judd	538
pinza de proteccion Adson	298	pinza hemostatica Crafoord	118	pinza intestinal Allis-Lockwood	538
pinza de reduction Reda	247	pinza hemostatica Crafoord-Sellors	119	pinza intestinal Allis-Thoms	538
pinza de relojero	90	pinza hemostatica Crile	107	pinza intestinal Babcock	539
pinza de rodillos	131	pinza hemostatica Crile-Coller	106	pinza intestinal Baby-Allis	537
pinza de traccion craneal Crutchfield	327	pinza hemostatica Crile-Rankin	107	pinza intestinal Baby-Doyen	540
pinza dental College-London	93	pinza hemostatica Dandy	109	pinza intestinal Baby-Kocher	540
pinza dental London-College	93	pinza hemostatica Desjardins	121	pinza intestinal Boys-Allis	538
pinza dental Meriam	93	pinza hemostatica Ferguson	109	pinza intestinal Brunner	543
pinza depilatoria Barraquer	395	pinza hemostatica Fuchsig	113	pinza intestinal Doyen	540
pinza depilatoria Beer	395	pinza hemostatica Geissendoerfer-Overholt	114	pinza intestinal Doyen-Baby	540
pinza depilatoria Douglas	395	pinza hemostatica Gemini	115	pinza intestinal Fehland	542
pinza depilatoria Gradle	395	pinza hemostatica Gray	121	pinza intestinal Gregoire	538
pinza depilatoria Littauer	395	pinza hemostatica Guyon	122	pinza intestinal Judd-Allis	538
pinza depilatoria Reda	395	pinza hemostatica Guyon-Mayo	122	pinza intestinal Kocher	540
pinza estomacal Lane	548	pinza hemostatica Halsted-Mosquito	105	pinza intestinal Kocher-Baby	540
pinza gubia Adson	236	pinza hemostatica Hartmann	104	pinza intestinal Littlewood	538
pinza gubia Bane-Hartmann	237	pinza hemostatica Heiss	112	pinza intestinal Lockwood-Allis	538
pinza gubia Beyer	237, 238	pinza hemostatica Hopkins-Johns	120	pinza intestinal Mayo-Robson	541
pinza gubia Blumenthal	236	pinza hemostatica Hospital-Providence	106	pinza intestinal Mikulicz	543
pinza gubia Böhler	238	pinza hemostatica Johns-Hopkins	120	pinza intestinal Resano	542
pinza gubia Cleveland	235	pinza hemostatica Kantrowitz	119/1	pinza intestinal Robson-Mayo	541
pinza gubia Echlin	240	pinza hemostatica Lahey	119/2, 120	pinza intestinal Scudder	541
pinza gubia Friedmann	234	pinza hemostatica Lawrence	119	pinza intestinal Stone-Watt	545
pinza gubia Friedmann Micro	234	pinza hemostatica Leriche	111	pinza intestinal Thoms-Allis	538
pinza gubia Friedmann Mini	234	pinza hemostatica Lovelace	109	pinza intestinal Watt-Stone	545
pinza gubia Frykholm	240	pinza hemostatica Lower	120	pinza intestinal y estomacal Baby-Payr	549
pinza gubia Hartmann-Bane	237	pinza hemostatica Martel	110	pinza intestinal y estomacal Payr	549
pinza gubia Jansen	237	pinza hemostatica Martel Willet	110	pinza intestinal y estomacal Payr-Baby	549
pinza gubia Jansen-Zaufal	238	pinza hemostatica Mayo-Guyon	122	pinza maleolar	247
pinza gubia Kleinert-Kutz	237	pinza hemostatica Meeker	119	pinza monopolares	634
pinza gubia Kutz-Kleinert	237	pinza hemostatica Mixer	116, 119/1-120	pinza muscular Berke	389
pinza gubia Leksell (Stille)	240	pinza hemostatica Mixer Baby	119/1	pinza muscular Mastin	479
pinza gubia Lempert	237	pinza hemostatica Mixer-O'Shaughnessy	119/2	pinza muscular Prince	386
pinza gubia Luer	236	pinza hemostatica Mixer-Overholt	115	pinza muscular Snellen	393
pinza gubia Luer-Stille	239	pinza hemostatica Mosquito-Halsted	105	pinza nasal Barbon-Lubet	424
pinza gubia Marquardt	239	pinza hemostatica Moynihan	120	pinza nasal Blakesley-Weil	426
pinza gubia Mayfield	238	pinza hemostatica Nissen	113	pinza nasal Bruenings	425
pinza gubia Mead	235	pinza hemostatica Ochsner-Rochester	108	pinza nasal Gruenwald-Jansen	424
pinza gubia Micro Friedmann	234	pinza hemostatica O'Shaughnessy-Mixer	119/2	pinza nasal Hartmann	424, 427
pinza gubia Mini Friedmann	234	pinza hemostatica Overholt	114	pinza nasal Heymann	425
pinza gubia Olivecrona	237	pinza hemostatica Overholt-Baby	114	pinza nasal Heymann-Knight	425
pinza gubia Petersen-Smith	238	pinza hemostatica Overholt-Geissendoerfer	114	pinza nasal Jansen	424
pinza gubia Ruskin	239	pinza hemostatica Overholt-Mixer	115	pinza nasal Jansen-Gruenwald	424
pinza gubia Ruskin-Stille	239	pinza hemostatica Pean	108, 110	pinza nasal Knight	425
pinza gubia Sauerbruch	240	pinza hemostatica Pean-Rochester	108	pinza nasal Knight-Heymann	425
pinza gubia Scaglietti	240			pinza nasal Lubet-Barbon	424
pinza gubia Semb	240			pinza nasal Luc	426
pinza gubia Smith-Petersen	238			pinza nasal Myles	427

pinza nasal Schmeden.....	427	pinza para calculos biliares Desjardins.....	530/2	pinza para histerectomia Maingot.....	123/1, 123/2
pinza nasal Struckyen.....	427	pinza para calculos biliares Mayo-Blake.....	530/2	pinza para histerectomia Segond.....	125
pinza nasal Takahashi.....	427	pinza para calculos biliares Mixer.....	530/2	pinza para histerectomia Segond-Landau.....	125
pinza nasal Troeltsch.....	424	pinza para calculos renales Heiming.....	536	pinza para histerectomia Wertheim.....	124, 128
pinza nasal Watson-Williams.....	428	pinza para calculos renales Randall.....	535	pinza para histerectomia Wertheim-Cullen.....	125
pinza nasal Weil-Blakesley.....	426	pinza para cambiar hojas.....	179	pinza para hueso Bircher-Ganske.....	246
pinza nasal Westmacott.....	424	pinza para campo Ball and Socket.....	133	pinza para hueso Dingmann.....	246
pinza nasal Williams-Watson.....	428	pinza para campo Lorna.....	133	pinza para hueso Farabeuf.....	243
pinza para aborto Saenger.....	606	pinza para campo Socket and Ball.....	133	pinza para hueso Farabeuf-Lambotte.....	243
pinza para aborto Winter.....	606	pinza para cartilagos Martin.....	246	pinza para hueso Ferguson.....	243
pinza para agarrar el bocio Lahey.....	479	pinza para cateter Cooley.....	510	pinza para hueso Ganske-Bircher.....	246
pinza para amigdalas Marschik.....	468	pinza para cerrar clamps DeMartel-Wolfson.....	546-547	pinza para hueso Kern.....	244
pinza para anastomosis Beck.....	516, 520	pinza para cerrar clamps Stone.....	545	pinza para hueso Lambotte.....	244
pinza para anastomosis Cooley.....	519-520/4	pinza para cerrar clamps Wolfson-DeMartel.....	546	pinza para hueso Lambotte-Farabeuf.....	243
pinza para anastomosis Cooley-Derra.....	519	pinza para chalazion Desmarres.....	393	pinza para hueso Lane.....	244
pinza para anastomosis DeBakey.....	505, 515	pinza para chalazion Lambert.....	393	pinza para hueso Langenbeck.....	243
pinza para anastomosis DeMartel-Wolfson.....	546-547	pinza para coartacion Potts.....	492	pinza para hueso Lewin.....	246
pinza para anastomosis Derra.....	515	pinza para coger amigdalas Abraham.....	468	pinza para hueso Patella.....	248
pinza para anastomosis Derra-Cooley.....	519	pinza para coger amigdalas Ballenger.....	467	pinza para hueso Reda.....	246
pinza para anastomosis Hayes.....	545	pinza para coger amigdalas Blohmke.....	467	pinza para hueso Reill.....	248
pinza para anastomosis Kay-Lambert.....	505	pinza para coger amigdalas Colver.....	467	pinza para hueso Semb.....	243
pinza para anastomosis Lambert-Kay.....	505	pinza para coger amigdalas Negus.....	467	pinza para hueso Ulrich.....	248
pinza para anastomosis Potts.....	493	pinza para coger amigdalas Sawtell.....	467	pinza para hueso Verbrugge.....	245
pinza para anastomosis Wolfson-DeMartel.....	546	pinza para coger amigdalas Schnidt.....	467	pinza para huesos.....	243-250
pinza para aneurisma Bahnon-DeBakey.....	506	pinza para coger amigdalas Tyding.....	468	pinza para huesos autocentrantes.....	245
pinza para aneurisma de la aorta DeBakey.....	496-498	pinza para coger amigdalas White.....	467	pinza para huesos Feldheim.....	249
pinza para aneurisma DeBakey-Bahnon.....	506	pinza para coger el pulmon Lovelace.....	490	pinza para huesos Hognlund-Lowman.....	249
pinza para apendice Allen.....	544	pinza para columna Cottle.....	448	pinza para huesos Lambert-Lowman.....	249
pinza para aplicar agrafes Childe.....	224	pinza para cordon espermatico.....	553/2	pinza para huesos Lowman.....	249
pinza para aplicar agrafes Wachenfeldt.....	224	pinza para cuerpos extraños Mathieu.....	553/1	pinza para huesos Lowman-Hognlund.....	249
pinza para aplicar y quitar agrafes Michel.....	224	pinza para desechos Sauerbruch.....	227	pinza para huesos Lowman-Lambert.....	249
pinza para arrancar uñas Radolf.....	297	Pinza para diseccion y ligatura		pinza para huesos Meyer.....	248
pinza para arrancar vendaje enyesado Wolff.....	233	DE BAKY SATINSKY.....	504/1	pinza para introducir cateter Magill.....	28
pinza para biopsia Alexander.....	589	pinza para el pene Stockmann.....	553/1	pinza para iris Barraquer (Colibri).....	384
pinza para biopsia Baby Burke.....	590	pinza para el pene Strauss.....	553/1	pinza para iris Barraquer-Katzin.....	384
pinza para biopsia Baby-Tischler.....	592	pinza para el tunel del tendon.....	293	pinza para iris Bishop-Harman.....	386
pinza para biopsia Burke.....	590	pinza para el utero Collin.....	585	pinza para iris Colibri.....	384
pinza para biopsia Burke Baby.....	590	pinza para el utero Dartigues.....	585	pinza para iris Colibri (Barraquer).....	384
pinza para biopsia Down-Mini-Townsend.....	591	pinza para el utero Somer.....	585	pinza para iris Colibri (Troutman).....	384
pinza para biopsia Down-Tischler.....	591	pinza para enderezar el tabique nasal Asch.....	449	pinza para iris Fischer.....	384
pinza para biopsia Eppendorfer.....	590	pinza para enderezar el tabique nasal Walsham.....	449	pinza para iris Foerster.....	383
pinza para biopsia Faure.....	588	pinza para espinas.....	91, 92	pinza para iris Gill.....	384
pinza para biopsia Gaylor-Thomas.....	588	pinza para espinas Archer.....	92	pinza para iris Gill-Hess.....	384
pinza para biopsia Grasper Maxi.....	593	pinza para espinas Carmalt.....	91	pinza para iris Graefe.....	382
pinza para biopsia Grasper Serpentine.....	593	pinza para espinas Feilchenfeld.....	91	pinza para iris Harman-Bishop.....	386
pinza para biopsia Kevorkian.....	589, 591	pinza para espinas Hunter.....	91	pinza para iris Hess.....	384
pinza para biopsia Kevorkian-Pacific.....	592	pinza para espinas Peet.....	92	pinza para iris Hess-Gill.....	384
pinza para biopsia Kevorkian-Tischler.....	592	pinza para espinas Stieglitz.....	92	pinza para iris Katzin-Barraquer.....	384
pinza para biopsia Maxi Grasper.....	593	pinza para esterilizacion.....	227	pinza para iris Stevens.....	383
pinza para biopsia Mini-Townsend-Down.....	591	pinza para esterilizacion Cheatle.....	227	pinza para iris Troutman.....	389
pinza para biopsia Mini-Townsend-Up.....	591	pinza para esterilizacion de jeringas Davis.....	227	pinza para iris Troutman (Colibri).....	384
pinza para biopsia Morgan-Tischler.....	590, 591	pinza para esterilizacion Rogge.....	227	pinza para la aorta DeBakey-Morris.....	506
pinza para biopsia Pacific-Kevorkian.....	592	pinza para esterilizacion Universal.....	227	pinza para la aorta Dietrich.....	510
pinza para biopsia Schubert.....	588	pinza para estrabismo Bonaccolto.....	385	pinza para la aorta Morris-DeBakey.....	506
pinza para biopsia Schumacher.....	588, 589	pinza para estrabismo Dasloor.....	386	pinza para la aorta Weber.....	501
pinza para biopsia Serpentine Grasper.....	593	pinza para estrabismo Jameson.....	385	pinza para la aorta Wylie.....	501/1, 501/2
pinza para biopsia Thomas-Gaylor.....	588	pinza para estrabismo McCullough.....	385	pinza para laringe Fraenkel.....	471
pinza para biopsia Tischler-Baby.....	592	pinza para fijacion Arthur-Kirby.....	385	pinza para ligadura Ayer.....	393
pinza para biopsia Tischler-Down.....	591	pinza para fijacion Barraquer.....	390	pinza para ligadura DeBakey.....	493, 499-500
pinza para biopsia Tischler-Kevorkian.....	592	pinza para fijacion Castroviejo.....	390	pinza para ligadura McPherson.....	392
pinza para biopsia Tischler-Morgan.....	590, 591	pinza para fijacion Cottle.....	410	pinza para ligadura Millin.....	551
pinza para biopsia Tischler-Up.....	591	pinza para fijacion Elschnig.....	389	pinza para ligadura Mod. Tübingen.....	392
pinza para biopsia Townsend.....	591	pinza para fijacion Graefe.....	389	pinza para ligadura Pauflue.....	392
pinza para biopsia Townsend-Down-Mini.....	591	pinza para fijacion Green.....	390	pinza para ligadura Tübingen Mod.....	392
pinza para biopsia Townsend-Up-Mini.....	591	pinza para fijacion Kirby-Arthur.....	385	pinza para ligadura y la aorta DeBakey-Semb.....	499
pinza para biopsia Up-Mini-Townsend.....	591	pinza para fijacion Lester.....	389	pinza para ligadura y la aorta Semb-DeBakey.....	499
pinza para biopsia Up-Tischler.....	591	pinza para hemorroides McGivney.....	568	pinza para ligaduras DeBakey-Mixer.....	499/2
pinza para biopsia Van Doren.....	588	pinza para hipofisis Adson.....	334	pinza para ligaduras DeBakey-Rumel.....	499
pinza para biopsia Wittner.....	589	pinza para histerectomia Ballentine-Heany.....	127	pinza para ligaduras Mixer-DeBakey.....	499/2
pinza para biopsia Yeoman.....	566	pinza para histerectomia Cullen-Wertheim.....	125	pinza para ligaduras Rumel-DeBakey.....	499
pinza para bronco-esofagoscopia Chevalier-Jackson.....	473	pinza para histerectomia Heaney.....	126	pinza para lobo anterior Millin.....	551
pinza para bronco-esofagoscopia Jackson-Chevalier.....	473	pinza para histerectomia Heany-Ballentine.....	127	pinza para magullar tabique Rubin.....	428
pinza para calculos biliares Blake.....	530/2	pinza para histerectomia Holzbaoh.....	126	pinza para medicacion Bryant.....	137
pinza para calculos biliares Blake-Mayo.....	530/2	pinza para histerectomia Landau-Segond.....	125	pinza para microcirugia.....	96

pinza para micro-cirugía de la laringe.....	474	pinza porta esponja Collin.....	137	polipotomo Voss-Krause.....	433/2
pinza para oclusion tangencial DeBakey-Satinsky.....	502	pinza porta esponja Douglas-Bozemann.....	138	polipotomo Wilde.....	433/2
pinza para oclusion tangencial Satinsky-DeBakey.....	502	pinza porta esponja Lister (Sinus).....	137	Politzer aguja para paracentesis.....	408
pinza para parametrio.....	128/1	pinza porta esponja Pelkmann.....	137	Politzer cuchillo auricular.....	408
pinza para parametrio Reda.....	128/1	pinza porta esponja Sinus (Lister).....	137	Politzer especulo auricular.....	399
pinza para pediculo Herrick.....	123	pinza porta-esponja Duplay.....	134	Poole tubo de aspiracion.....	27
pinza para pericraneo Gauss.....	605	pinza porta-esponja Gross-Maier.....	134	porta aguja (micro) Barraquer.....	216, 217
pinza para peritoneo Faure.....	123	pinza porta-esponja Maier-Gross.....	134	porta aguja (micro) Barraquer-Troutmann.....	216
pinza para peritoneo Mikulicz.....	123	pinza porta-esponja Maier-Sims.....	134	porta aguja (micro) Castroviejo-Standard.....	216
pinza para peritoneo Phaneuf.....	123	pinza porta-esponja Sims-Maier.....	134	porta aguja (micro) Standard-Castroviejo.....	216
pinza para polipos Hartmann.....	412	pinza sacabocado Citelli.....	430	porta aguja (micro) Troutmann-Barraquer.....	216
pinza para polipos Hartmann-Hoffmann.....	412	pinza sacabocado craneal Cone.....	331	porta aguja Adson.....	211
pinza para polipos Hartmann-Wullstein.....	412	pinza sacabocado craneal DeVilbiss.....	332	porta aguja Arruga.....	214
pinza para polipos Hoffmann-Hartmann.....	412	pinza sacabocado Hajek-Kofler.....	431	porta aguja Arruga-Kalt.....	214
pinza para polipos laringeos Jurasz.....	471	pinza sacabocado Kofler-Hajek.....	431	porta aguja Baby-Olsen-Hegar.....	212
pinza para polipos Littauer.....	425	pinza sacabocado Ostroem.....	430	porta aguja Baumgartner.....	208
pinza para polipos Noyes.....	425	pinza sacabocado para discos.....		porta aguja Boynton.....	214
pinza para polipos Struempel.....	412	intervertebral Colclough.....	344/1	porta aguja Bozemann.....	211
pinza para polipos uterinos Doyen.....	585	pinza sacabocado para discos.....		porta aguja Brown.....	219
pinza para polipos uterinos Kelly.....	585	intervertebral Ferris-Smith-Kerrison.....	344, 344/2	porta aguja Castroviejo.....	205
pinza para polipos uterinos Noto.....	585	pinza sacabocado para discos.....		porta aguja Castroviejo-Micro.....	215
pinza para polipos Wullstein-Hartmann.....	412	intervertebral Kerrison-Ferris-Smith.....	344, 344/2	porta aguja Collier.....	208
pinza para quitar agrafes Collin.....	224	pinza sacabocado para discos.....		porta aguja Crile.....	213
pinza para quitar agrafes Heath-Richter.....	224	intervertebral Smith-Kerrison-Ferris.....	344, 344/2	porta aguja Crile-Murray.....	209
pinza para quitar agrafes Richter-Heath.....	224	pinza Smith.....	463	porta aguja Crile-Wood.....	210
pinza para reduction.....	246	pinza tira-lengua Collin.....	453	porta aguja DeBakey.....	209
pinza para reposicion Rowe.....	459	pinza tira-lengua Young.....	453	porta aguja Derf.....	208
pinza para secuestros.....	249	pinza Ultra-Ligera.....	95	porta aguja Finocchio.....	211
pinza para secuestros Van Buren.....	249	pinza uterina Adair.....	582	porta aguja Gillies.....	212
pinza para senoscopia.....	431	pinza uterina Barrett.....	582	porta aguja Halsey.....	208
pinza para separar la rama Smith.....	463	pinza uterina Braun.....	582	porta aguja Heaney.....	210
pinza para shunt carotido Javid.....	511	pinza uterina Czerny.....	584	porta aguja Hegar-Baby-Olsen.....	212
pinza para sostener placas Lane.....	325	pinza uterina Duplay.....	582	porta aguja Hegar-Mayo.....	209
pinza para sostener tornillos Lane.....	325	pinza uterina Hulka.....	583	porta aguja Hegar-Olsen.....	212
pinza para sutura Bonn Mod.....	386	pinza uterina Iowa.....	584	porta aguja Hoessel.....	213
pinza para sutura Castroviejo.....	392	pinza uterina Jacobs.....	583	porta aguja Jacobsen.....	215
pinza para sutura Mod. Bonn.....	386	pinza uterina Jarcho.....	583	porta aguja Kalt.....	214
pinza para sutura Mod. Tübingen.....	386	pinza uterina Moore-Staude.....	582	porta aguja Kalt-Arruga.....	214
pinza para sutura Moorfield.....	392	pinza uterina Museux.....	583	porta aguja Kilner.....	212
pinza para sutura St. Martin.....	392	pinza uterina Palmer-Pozzi.....	582	porta aguja Langenbeck.....	213
pinza para sutura Tübingen Mod.....	386	pinza uterina Pozzi (Schroeder).....	582	porta aguja Masson.....	210
pinza para tabique nasal Craig.....	426	pinza uterina Pozzi-Palmer.....	582	porta aguja Mathieu.....	213
pinza para tabique nasal Jansen-Middleton.....	430	pinza uterina Pratt.....	584	porta aguja Mathieu-Olsen.....	212
pinza para tabique nasal Middleton-Jansen.....	430	pinza uterina Schröder.....	584	porta aguja Mayo-Hegar.....	209
pinza para tapones.....	135, 471	pinza uterina Schroeder.....	583	porta aguja Metzbaum.....	211
pinza para tapones Jackson.....	471	pinza uterina Schroeder (Pozzi).....	582	porta aguja Micro-Castroviejo.....	215
pinza para tapones Ulrich.....	135	pinza uterina Skene.....	582	porta aguja Microvascular.....	210
pinza para tejido Collin.....	539	pinza uterina Staude-Moore.....	582	porta aguja Murray-Crile.....	209
pinza para tejido Duval.....	539	pinza uterina Teale.....	583	porta aguja Neivert.....	208
pinza para tejido Williams.....	539	pinza vascular Cooley.....	520	porta aguja Olsen-Hegar.....	212
pinza para tendones Larsen.....	292	pinza vascular Dardik.....	509/1	porta aguja Olsen-Hegar-Baby.....	212
pinza para torcer hilo Berry.....	319	pinza vascular de uso multiple Bainbridge.....	495/1-495/2	porta aguja Olsen-Mathieu.....	212
pinza para torcer hilo Corwin-Hegar.....	319	pinza vascular de uso multiple Cooley.....	518-520, 520/2	porta aguja Ryder.....	210
pinza para torcer hilo Haberisser-Mayo.....	319	pinza vascular de uso multiple.....		porta aguja Sarot.....	211
pinza para torcer hilo Hegar-Corwin.....	319	DeBakey.....	495/2, 507, 508, 514, 515	porta aguja Stevens.....	214
pinza para torcer hilo Mayo-Haberisser.....	319	pinza vascular Neonatal.....	523	porta aguja Stratte.....	212
pinza para tracoma Knapp-Luer.....	393	pinza vascular para neotales Castaneda.....	527	porta aguja Wangenstein.....	210
pinza para tracoma Luer-Knapp.....	393	pinza vascular pediatrica Cooley.....	522	porta aguja Webster.....	208
pinza para tumores Yasargil.....	97	pinza vascular pediatrica DeBakey.....	516, 517	porta aguja Wood-Crile.....	209
pinza para uso multiple Glover.....	515	Pinzas de campos OMBREDANNE (JACKSON).....	133	porta esponjas Foerster.....	136
pinza para uterus Armytage-Green.....	605	Pinzas de disección, sin/con dientes DENIS- BROWNE.....	89	porta esponjas Rampley.....	136
pinza para uterus Green-Armytage.....	605	Pinzas hemostáticas CHRISTOPHE.....	107	porta ligadura para tournique.....	528
pinza para vascotomia.....	553/2	Pinzas hemostáticas TERRIER.....	106	porta pinza de traslado.....	615
pinza para vasos Biemer.....	361	Pinzas para preparaciones y para ligaduras.....	128/2	porta-algodon.....	203
pinza para vasos Mehdorn.....	362	Pinzas RESANO.....	85	porta-algodon Farrell.....	203
pinza para vasos perifericos Dale.....	495	Piper forceps obstetrico.....	604	porta-algodon Home-Jobson.....	203
pinza para vasos perifericos DeBakey.....	494	Pistola lavadora.....	626	porta-algodon Jobson-Horne.....	203
pinza para vasos perifericos Jones-Leland.....	495	placa para extender la piel.....	49	porta-algodon Reda.....	203
pinza para vasos perifericos Leland-Jones.....	495	placa para parpado Jaeger.....	371	porta-algodon Tobold.....	203
pinza para vasos Satinsky.....	491	Plester cuchillo.....	418	porta-algodon Uckermann.....	203
pinza pico plano.....	317, 320	Plester separador.....	171	porta-clamps DeMartel-Wolfson.....	546-547
pinza porta esponja Bozemann.....	138	Plester tubo de aspiracion.....	338	porta-clamps Wolfson-DeMartel.....	546-547
pinza porta esponja Bozemann-Douglas.....	138	polipotomo Krause.....	433/2	portador de luz fria Kleinsasser.....	36
pinza porta esponja Cheron.....	137	polipotomo Krause-Voss.....	433/2	Potts pinza para anastomosis.....	493

Potts pinza para coartacion	492
Potts-DeMartel tijera vascular	59
Potts-Smith pinza de diseccion	81, 81/1
Potts-Smith tijera vascular	61
Pozzi (Schroeder) pinza uterina	582
Pozzi-Palmer pinza uterina	582
Pratt dilatador uterino	580
Pratt especulo rectal	559
Pratt pinza hemostatica	110
Pratt pinza uterina	584
Pratt sonda para fistula	563
Presbyterian pinza cierra-tubo	129
Price-Thomas pinza bronquial	490
Prince pinza muscular	386
Prince tijera para amigdalas	59
proctoscopio Bensaude	565
proctoscopio Fansler	564
proctoscopio Kelly	562, 563
proctoscopio Morgan	565
Proctoscopios MORGAN	565
Providence-Hospital pinza hemostatica	106
punta de pinza Baracani	472
punta de pinza Bruenings	472
punta de pinza Cordes	472
punta de pinza Fraenkel	472
punta de pinza Krause	472
punta de pinza Lange	472
punta de pinza Scheinmann	472
punta de pinza Schumacher	472
punta de pinza Seifert	472
Punzón OMBREDANNE	304
Putti lima para huesos	294
Pynchon-Andrew tubo de aspiracion	28

Q

Quervain periostotomo	275
Quincy tijera para encias	67
Quire elevador para cuerpos extraños	412
Quisling martillo	271
quistotomo Becker	375
quistotomo Graefe	375
quita hojas	42

R

Radolf pinza para arrancar uñas	297
Ragnell separador	140
Ragnell/Kilner tijera supercut	72
Raik perforador de mano	299
Rampley porta esponjas	136
Ramus separador para el ramo	461
Randall cureta aspiradora para biopsia uterina	587
Randall pinza para calculos renales	535
Raney grapa para cuero cabelludo	327
Raney pinza aplicadora	327
Rankin-Crile pinza hemostatica	107
Rankin-DeBakey pinza hemostatica atraumatica	512
Rankin-Kelly pinza hemostatica	106
raquiotomo	267
Ray cureta para hipofisis	334
Recamier cureta uterina	597
Reda cucharilla cortante	256
Reda cuchillo de hoz	435
Reda cuchillo para amputacion	44
Reda diapason	403
Reda especulo nasal	423
Reda Excenter tijera para vendaje	69/2
Reda gancho	150
Reda iman ocular	395
Reda instrumento para vendaje enyesado	232
Reda micro tijera	77, 80
Reda perforador de mano	299
Reda pinza atraumatica	111

Reda pinza autocentradora para sostener huesos	247
Reda pinza de reduction	247
Reda pinza depiladora	395
Reda pinza para hueso	246
Reda pinza para parametro	128/1
Reda porta-algodon	203
Reda rompe hojas	45
Reda sierra para abrir anillos	297
Reda sonda conductora	221/1
Redon aguja de guia	207
Rees tijera face lift	73
regla	25
Reill pinza para hueso	248
Reiner cuchillo para vendaje enyesado	233
Reiner jeringa auricular	407
Reinke-Lopez elevador para amigdalas	465
Resano pinza intestinal	542
Resano Pinzas	85
Resano tijera para capsula	53/2
Retractor con mango triangular	
Langenbeck-Mannerfelt	148/4
Retractor con mango triangular	
Mannerfelt	148/3, 148/4, 148/5
retractor nasal Aufricht	447
retractor nasal Cottle	447, 447/1
retractor nasal Kilner	447/1
retractor nasal Masing	447
retractor nasal Masing-Neivert	447
retractor nasal Neivert-Masing	447
retractor para amputacion Percy	296
Reverdin aguja	220
Reverdin separador abdominal	143/3
Reynolds tijera para cirugia	54/1
Reynolds tijera supercut	72
Ribbon espátula abdominal	143/1
Ricard separador abdominal	191
Richardson Grip separador	142
Richardson separador	142
Richardson-Eastman separador	142
Richter-Heath pinza para quitar agrafes	224
Rigby separador	189/2
Ri-Mini estuche de diagnostico	17
Ring baja-lengua	455
riñoneras	619
Ritter-Halle dilatador para el seno	433
Robb disecador vascular	530
Robb espátula para la intima	530
Roberts pinza hemostatica	117
Robson-Mayo pinza intestinal	541
Rochard separador abdominal	186
Rochester-Carmalt pinza hemostatica	109
Rochester-Ochsner pinza hemostatica	108
Rochester-Pean pinza hemostatica	108
Roeder pinza de campo	132
Roger elevador para el tabique nasal	437
Roger pinza atraumatica	127
Rogge pinza para esterilizacion	227
Rollet cincel para extirpacion	374
Rollet gancho	375
rompe hojas Castroviejo	45
rompe hojas Chris-Troutman	45
rompe hojas Reda	45
rompe hojas Troutman-Chris	45
Rose separador	140
Rosen gancho	418
Rosen tubo de aspiracion	338
Roser-Koenig abre-boca	458
Ross separador	148/1
Ross separador para aorta	148/1
Roux Baby separador	140
Roux mini separador	140
Roux separador	139
Rowe pinza para reposicion	459

Rubin cincel nasal	440
Rubin pinza para magullar tabique	428
Rudd ligador para hemorroides	568
Rumel pinza hemostatica	117
Rumel-Belmont tournique	528
Rumel-DeBakey pinza para ligaduras	499
Ruskin pinza gubia	239
Ruskin-Liston pinza cortante para huesos	241
Ruskin-Stille pinza gubia	239
Russel-Davis baja-lengua	458
Rydel-Seiffert diapason	404
Ryder porta aguja	210

S

Saalfeld saca comedones	608
saca comedones Saalfeld	608
saca comedones Schamberg	608
saca comedones Unna	608
saca comedones Walton	608
Sachs elevador para duramadre	332
Sachs gancho para nervio	329
Saenger pinza para aborto	606
salpingografo Schultze	596
Sanvenero tijera para cirugia	54/1
Sarot pinza hemostatica	118
Sarot porta aguja	211
Satinsky pinza para vasos	491
Satinsky tijera para vasija	65/2
Satinsky-DeBakey pinza para oclusion tangencial	502
Satterlee sierra para amputacion	296
Sauerbruch costotomo	481
Sauerbruch pinza gubia	240
Sauerbruch pinza para desechos	227
Sauerbruch separador	164, 166
Sawtell pinza para coger las amigdalas	467
Sawyer especulo rectal	560
Sayre elevador	281
Scaglietti pinza gubia	240
Scalp-Contour separador	169
Scapula (Davidson) separador	166
Schaedel pinza de campo	132
Schamberg saca comedones	608
Schede cucharilla cortante	251
Scheidel-Happ micro tijera	78
Scheie cuchillo para goniotomia	373
Scheinmann punta de pinza	472
Scherbak especulo vaginal	575
Schimmelbusch tambores para esterilizacion	622
Schink dermatomo	49
Schioetz tonometro	394/2
Schlesinger pinza cortante para laminectomia	342
Schmeden pinza nasal	427
Schmid canula para lavador vascular	338
Schmidt-Moritz baja-lengua	452
Schmieden sonda conductora	221
Schmieden-Dick aguja para ligadura	219
Schmieden-Taylor tijera duramadre	65/1
Schmidt pinza para coger las amigdalas	467
Schoenborn separador para la glandula tiroidea	479
Schröder cureta uterina	595
Schröder pinza uterina	584
Schroeder (Pozzi) pinza uterina	582
Schroeder pinza uterina	583
Schubert pinza para biopsia	588
Schuhknecht cuchillo	418
Schultze salpingografo	596
Schulze-Bergmann especulo rectal	560
Schumacher pinza para biopsia	588, 589
Schumacher punta de pinza	472
Schumacher tijera para cordon umbilical	64
Schumacher tijera para esternon	481
Schweigger pinza capsular	391
Scoville cucharilla cortante	253

Scoville separador para la raiz de nervios.....	329/1, 330	separador costal Cooley.....	485, 487	separador Mayo-Adams.....	171
Scoville separador para laminectomia.....	196	separador costal Favalaro-Morse.....	484	separador Mayo-Collins.....	141
Scoville-Haverfield separador para laminectomia.....	196	separador costal Finochietto.....	482, 484	separador Meyerding.....	157, 177, 180
Scudder pinza intestinal.....	541	separador costal Finochietto-Burford.....	483	separador Middeldorf.....	160
Sebleau periostotomo.....	275	separador costal Haight.....	487	separador Mikulicz.....	163
Sedillot periostotomo.....	274, 275	separador costal Morse.....	484	separador Miller-Senn.....	143
Segond pinza para histerectomia.....	125	separador costal Morse-Favaloro.....	484	separador Mini Roux.....	140
Segond-Landau pinza para histerectomia.....	125	separador costal Tuffier.....	487	separador Mollison.....	171
Seifert punta de pinza.....	472	separador Crile.....	140	separador Morris.....	164
Seiffert-Rydel diaposon.....	404	separador cuello vejiga Millin.....	553	separador nasal Converse.....	448
Seldin periostotomo.....	277	separador Cushing.....	151-153	separador Norfolk / Norwich.....	172
Sellheim separador obstetrico.....	607	separador Czerny.....	141	separador Norwich / Norfolk.....	172
Sellors aproximador para costillas.....	489/1	separador Darling.....	178	separador obstetrico Sellheim.....	607
Sellors-Crafoord pinza hemostatica.....	119	separador Davidson (Scapula).....	166	separador Ollier.....	162
Semb periostotomo.....	278	separador de mobilizacion Tessier.....	463/3	separador para aorta Ross.....	148/1
Semb pinza bronquial.....	491	separador de pelvis St. Marks.....	165	separador para cirugia plastica Ferriera.....	197
Semb pinza cortante para huesos.....	242	separador de sistema Leyla.....	368-368/3	separador para cirugia plastica Tebbetts.....	197
Semb pinza gubia.....	240	separador Deaver.....	145, 146	separador para cuerpo vertebral Cloward.....	339
Semb pinza para hueso.....	243	separador Deaver Grip.....	146	separador para cuerpo vertebral Inge.....	339
Semb-DeBakey pinza para ligadura y la aorta.....	499	separador DeBakey.....	189/1	separador para el borde anterior Hargis.....	463
Semken pinza de diseccion.....	86	separador Desmarres.....	151	separador para el cuerpo mandibular Hargis.....	463/6
Semm especulo vaginal.....	571	separador Doyen.....	163	separador para el ramo Nasalis-Spina.....	461
Senn-Green separador.....	153	separador Doyen-Stille.....	167	separador para el ramo Ramus.....	461
Senn-Miller separador.....	143	separador Eastman-Richardson.....	142	separador para el ramo Spina-Nasalis.....	461
sensimetro Wartenberg.....	25	separador Eaton-Beckmann.....	176	separador para la glandula tiroidea Schoenborn.....	479
separador abdominal Baby Balfour.....	182, 183	separador espinal Taylor.....	291	separador para la raiz de nervios D'Errico.....	329/2
separador abdominal Baby Gosset.....	181	separador esternón.....	487/1	separador para la raiz de nervios Hess.....	329/1
separador abdominal Back holder.....	192-195	separador Farabeuf.....	139	separador para la raiz de nervios Holsher.....	329/1
separador abdominal Balfour.....	182, 183	separador Finsen.....	168	separador para la raiz de nervios Love.....	329/2, 330
separador abdominal Balfour Baby.....	182, 183	separador Freeman.....	198	separador para la raiz de nervios Scoville.....	329/1, 330
separador abdominal Balfour-US.....	184	separador Friedmann.....	477, 577	separador para labios y mejillas.....	453
separador abdominal Browne-Denis.....	185	separador Fritsch.....	163	separador para labios y mejillas Sternberg.....	453
separador abdominal Charnley.....	289	separador Gil-Vernet.....	152	separador para laminectomia Cherry.....	488
separador abdominal Collin.....	190	separador Goelet.....	141	separador para laminectomia Haverfield-Scoville.....	196
separador abdominal Collin Lokitte.....	191	separador Green.....	160	separador para laminectomia Scoville.....	196
separador abdominal Denis-Browne.....	185	separador Green-Langenbeck.....	153	separador para laminectomia Scoville-Haverfield.....	196
separador abdominal Doyen.....	189/1	separador Green-Senn.....	153	separador para menisco Smillie.....	291
separador abdominal Frazier.....	181	separador Grip Deaver.....	146	separador para paladar Nager.....	465
separador abdominal Gosset.....	181	separador Grip Kelly.....	142	separador para partes blandas Obwegeser.....	460
separador abdominal Gosset Baby.....	181	separador Grip Richardson.....	142	separador para pilar Hofer.....	465
separador abdominal Kirschner.....	187-187/1	separador Harrington.....	147	separador para piloro Benson.....	544
separador abdominal Kümmel.....	143/4	separador Harrington-Pemberton.....	147	separador para rodilla Blount.....	389
separador abdominal Lokitte Collin.....	191	separador Hartmann-Collin.....	141	separador para tejido cervical Cloward.....	239
separador abdominal O'Connor-O'Sullivan.....	181	separador Hasson.....	143	separador para tendones Bunell.....	292
separador abdominal O'Sullivan-O'Connor.....	181	separador Heaney.....	164	separador para uvula Love.....	465
separador abdominal Reverdin.....	143/3	separador Henley.....	170	separador para yesos Beeson.....	232
separador abdominal Ricard.....	191	separador Hibbs.....	164	separador para yesos Haglund-Stille.....	232
separador abdominal Rochard.....	186	separador Holzheimer.....	168	separador para yesos Henning.....	232
separador abdominal Us-Balfour.....	184	separador Hösel.....	167	separador para yesos Stille-Haglund.....	232
separador Adams-Mayo.....	171	separador intestinal Leriche.....	143/4	separador Parker.....	139
separador Adson.....	172-174	separador intra oral.....	463/1	separador Parker-Langenbeck / Us Army.....	141
separador Adson Anderson.....	172	separador Israel.....	162	separador Pemberton-Harrington.....	147
separador Adson-Beckmann.....	175	separador Jackson-Burrows.....	189/2	separador perineal Gelpi.....	189/1, 189/2
separador Alm.....	168	separador Jansen.....	168	separador Perkins.....	168
separador Anderson.....	198	separador Joll.....	477, 577	separador Plester.....	171
separador Anderson Adson.....	172	separador Kelly.....	142, 164	separador prostatico Young.....	550
separador Aufranc-Cobra.....	289	separador Kelly Grip.....	142	separador Ragnell.....	140
separador Baby Roux.....	140	separador Kocher.....	155	separador rectal Bue-Smith.....	561
separador Beckmann.....	176	separador Kocher.....	159, 160, 163	separador rectal Smith-Bue.....	561
separador Beckmann-Adson.....	175	separador Kocher-Langenbeck.....	159	separador Richardson.....	142
separador Beckmann-Eaton.....	176	separador Koerte.....	162	separador Richardson Grip.....	142
separador Brunner.....	167	separador König.....	153	separador Richardson-Eastman.....	142
separador Burrows-Jackson.....	189/2	separador Körte.....	143/3	separador Rigby.....	189/2
separador Caspar.....	179	separador Lahey.....	157	separador Rose.....	140
separador Cloward.....	178/1-178/4	separador Langenbeck.....	158, 159	separador Ross.....	148/1
separador Cobra-Aufranc.....	289	separador Langenbeck-Green.....	153	separador Roux.....	139
separador Collin.....	139	separador Langenbeck-Kocher.....	159	separador Roux Baby.....	140
separador Collin-Hartmann.....	141	separador Little.....	157	separador Roux mini.....	140
separador Collins-Mayo.....	141	separador Luer.....	140	separador sagital Smith.....	463/5
separador Contour-Scalp.....	169	separador mamaria.....	487/1	separador Sauerbruch.....	164, 166
separador Cooley.....	148	separador mamario Breast.....	198	separador Scalp-Contour.....	169
separador Coronol Blow Lift.....	198	separador manibular Obwegeser.....	461/1	separador Scapula (Davidson).....	166
separador Coryllos (Thorax).....	166	separador Martin.....	175/1	separador Senn-Green.....	153
separador costal Burford-Finochietto.....	483	separador Mathieu.....	141	separador Senn-Miller.....	143

separador Simon	164	Smellie gancho obstetrico	605	Stevens tijera para tenotomia	58
separador Stille-Doyen	167	Smellie perforacraneo	607	Stevens tijera supercut	72
separador Stille-Strandell	157	Smellie meniscotomo	292	Stevenson blearostato	371
separador Strandell-Stille	157	Smillie separador para menisco	291	Stiegiltz pinza para espinas	92
separador Thorax (Coryllos)	166	Smith pinza	463	Stille (Leksell) pinza gubia	240
separador traqueal Bose	476	Smith pinza para separar la rama	463	Stille cincel	260
separador traqueal Jackson	476	Smith separador sagital	463/5	Stille cizalla para yesos	229
separador Travers	172	Smith Us Army tijera para gaza	69/1	Stille costotomo	480
separador Tuffier	147	Smith-Buie separador rectal	561	Stille gubia	260
separador Us Army / Parker-Langenbeck	141	Smith-Ferris pinza cortante para laminectomia	343	Stille osteotomo	260
separador Vernet-Gil	152	Smith-Ferris pinza de diseccion	85	Stille pinza de diseccion	81, 81/1
separador vesical Judd-Masson	552	Smith-Heywood pinza hemorroidal	567	Stille pinza hemostatica	122
separador vesical Masson-Judd	552	Smith-Kerrison-Ferris pinza sacabocado		Stille-Barraya pinza de diseccion	88
separador vesical Millin	552	para discos intervertebral	344, 344/2	Stille-Giertz costotomo	481
separador vesical Thomson-Walker	552	Smith-Petersen cincel	261	Stille-Haglund separador para yesos	232
separador vesical Walker-Thomson	552	Smith-Petersen gubia	261	Stille-Horsley pinza cortante para huesos	242
separador Volkman	153-156	Smith-Petersen pinza gubia	238	Stille-Liston pinza cortante para huesos	242
separador Weitlaner	169	Smith-Potts pinza de diseccion	81, 81/2	Stille-Luer pinza gubia	239
separador Weitlaner-Wullstein	169	Smith-Potts tijera vascular	61	Stille-Mayo tijera de diseccion	52/1
separador Wullstein	171	Smithwick gancho para nervio	329	Stille-Mayo tijera supercut	71
separador Wullstein-Weitlaner	169	Smithwick pinza aplicadora	326	Stille-Ruskin pinza gubia	239
separador Yancoskie	198	Snellen asa	378	Stille-Strandell separador	157
separador Zenker	161	Snellen pinza muscular	393	Stockmann pinza para el pene	553/1
Separadores costales	487/2	Socket and Ball pinza para campo	133	Stone pinza para cerrar clamps	545
Separadores costales DE BAKEY	485/1	Somer pinza para el utero	585	Stone-Watt manguito de cierre	545
Separadores vesicales HRYNTSCHAK	553	Sonda abotonada Jacobson	335	Stone-Watt pinza intestinal	545
Serpentine Grasper pinza para biopsia	593	sonda acanalada	199	Strabismus tijera	58
serra-fina Dieffenbach	104	sonda acanalada Brodie	199	Strandell-Stille separador	157
serra-fina Hopkins-Johns	104	sonda conductora Brunner	221/1	Strassburger pinza de diseccion	89
serra-fina Johns-Hopkins	104	sonda conductora Kirschner	221	Stratte porta aguja	212
Seutin tijera para vendaje	69/2	sonda conductora Koenig	221/1	Strauss pinza para el pene	553/1
Sexton cuchillo auricular	408	sonda conductora Payr	221/1	Struempel pinza para polipos	412
Shambaugh gancho	419	sonda conductora Payr-Schmieden	221	Strully tijera para neurocirugia	65
Shapleigh asa	410	sonda conductora Reda	221/1	Struycken pinza nasal	427
Shea tijera auricular micro	413	sonda conductora Schmieden	221	supercut tijera	71, 72
Sheehan cincel nasal	441	sonda Fish	199	supercut tijera Baby Metzenbaum	71
Sheets canula	394/2	sonda Harms	381	supercut tijera Iris	72
Siebold tijera ginecologica	62	sonda lacrimal Bowman	381	supercut tijera Kilner/Ragnell	72
Siegle especulo auricular	402	sonda lacrimal Worst	381	supercut tijera La Grange	72
sierra hilo Olivecrona	332	sonda metalica Walther	555	supercut tijera Lister	72
sierra nasal Joseph	446	sonda Nelaton	199	supercut tijera Mayo	71
sierra oscilante con aspiracion	231-231/1	sonda para bocio Kocher	479	supercut tijera Mayo-Stille	71
sierra oscilante para vendajes enyesados	230/10-230/18	sonda para calculos biliares Mayo	534	supercut tijera Metzenbaum	71
sierra para abrir anillos Reda	297	sonda para fistula Lockhart-Mummery	200	supercut tijera Metzenbaum Baby	71
sierra para abrir anillos Walton	297	sonda para fistula Mummery-Lockhart	200	supercut tijera Ragnell/Kilner	72
sierra para amputacion Bier	296	sonda para fistula Pratt	563	supercut tijera Reynolds	72
sierra para amputacion Charriere	296	sonda para medir House	420	supercut tijera Stevens	72
sierra para amputacion Langenbeck	296	sonda para sinoscopia Sinus	438	supercut tijera Stille-Mayo	71
sierra para amputacion Satterlee	296	soporte de esterilizacion para alambres de Kirschner	305	supercut tijera wagner	72
sierra para autopsia	230-230/9	soporte de pecho Negus	459	systrunk tijera para cirugia	66
sierra para vendajes enyesados Engel	229	soporte pectoral Kleinsasser	36		
silleta	62/1/1	soporte pectoral LEWY	37		
Silver cincel nasal	442	Spencer tijera para ligadura	66		
Silver dermatomo	50	Spencer-Wells pinza hemostatica	109		
Simcoe canula	394/2	Spinal cucharilla cortante	253		
Simon cucharilla uterina	594	Spina-Nasalis separador para el ramo	461		
Simon separador	164	Spratt cucharilla cortante	251		
Simpson forceps obstetrico	602	Spurling pinza cortante para laminectomia	340		
Simpson-Braun forceps obstetrico	602	St. Marks separador de pelvis	165		
Simpson-Luikart forceps obstetrico	603	St. Martin pinza para sutura	392		
Sims cureta uterina	597	St. Clair-Thomson cuchillo p. vegetaciones adenoides	450		
Sims depresor uterino	586	Stamm pinza cortante para huesos	241		
Sims especulo rectal	559	Standard (Nelson) trocar abdominal	204		
Sims especulo vaginal	573	Standard pinza de diseccion	81, 81/1		
Sims histerometro	586	Standard tijera para cirugia	51		
Sims tijera ginecologica	62	standard Tijeras bipolares	634		
Sims-Maier pinza porta-esponja	134	Stauda-Moore pinza uterina	582		
Singley pinza de diseccion	88	Steinmann alambre	307, 308		
Sinskey gancho	376	Steinmann pinza de agarre para tendones	292		
Sinus (Lister) pinza porta esponja	137	Stelbrink pinza gubia	234		
Sinus sonda para sinoscopia	438	Stenberg separador para labios y mejillas	453		
sistema de brazo	188	Stevens gancho para cristalino	375		
Skene pinza uterina	582	Stevens pinza para iris	383		
Sluder-Ballenger amigdalotomo	470	Stevens porta aguja	214		

T

Tabb cuchillo	418
Takahashi pinza nasal	427
taladros	302
tambores para esterilizacion Schimmelbusch	622
tamponeador LUniatschek	465
Tarnier forceps obstetrico	604
tarros	620
Taylor martillo de percusion	24
Taylor pinza de diseccion	87
Taylor separador espinal	291
Taylor-Cushing pinza de diseccion	87
Taylor-Schmieden tijera duramadre	65/1
Taza del orinal female	621/2
Taza del orinal male	81, 81/1
Teale pinza uterina	583
Tebbetts separador para cirugia plastica	197
tensor de cierra-hilo Demel	315
tensor de cierra-hilo Loute	315
tensor de taladros	313
TERRIER Pinzas hemostáticas	106
Terson pinza capsular	391

Tessier separador de mobilizacion	463/3	tijera para cordon umbilical Busch	64	tijera vascular Kelly	61
Thiery forceps obstetricos	603	tijera para cordon umbilical Mod. USA	64	tijera vascular Potts-DeMartel	59
Thomas cureta uterina	599	tijera para cordon umbilical Schuhmacher	64	tijera vascular Potts-Smith	61
Thomas-Gaylor pinza para biopsia	588	tijera para cordon umbilical USA Mod	64	tijera vascular Smith-Potts	61
Thomas-Price pinza bronquial	490	tijera para corneas Castroviejo	79	tijera vasija Satinsky	65/2
Thoms-Allis pinza intestinal	538	tijera para encias Fox-Goldman	67	tijera Wagner	67
Thomson-St.Clair cuchillo		tijera para encias Goldman-Fox	67	Tijeras de diseccion METZENBAUM	53/3, 53/4
para vegetaciones adenoides	450	tijera para encias LaGrange	69	Tilley pinza auricular	411
Thomson-Walker separador vesical	552	tijera para encias Locklin	69	tirabuzon para fibroma Doyen	594
Thorax (Coryllos) separador	166	tijera para encias Quinby	67	Tischler-Down pinza para biopsia	591
Thorex tijera vesicula biliar	65/2	tijera para enterotomo	66	Tischler-Kevorkian pinza para biopsia	592
Thudichum especulo nasal	421	tijera para episiotomia Braun-Stadler	64	Tischler-Morgan pinza para biopsia	590, 591
Tieck-Halle especulo nasal	423	tijera para episiotomia Stadler-Braun	64	Tischler-Up pinza para biopsia	591
tijera Adson-Toennis	65	tijera para esternon Schumacher	481	Tobold baja-lengua	453
tijera auricular micro Bellucci	413, 417	tijera para gaza Smith Us Army	69/1	Tobold porta-algodon	203
tijera auricular micro Shea	413	tijera para gaza US Army Smith	69/1	Todd-Wadsworth cauterio	378
tijera Cartilage-Martin	65/1	tijera para intestino Fergusson	66	Toennis elevador para duramadre	332
tijera cuticular	610	tijera para iridectomia Castroviejo	79	Toennis pinza hemostatica	117
tijera de diseccion Baby Lexer	53	tijera para iridectomia Vannas	79	Toennis-Adson tijera	65
tijera de diseccion Deaver	52	tijera para iris Noyes	75	Toennis-Olivecrona pinza aplicadora	326
tijera de diseccion Jorgensen	53	tijera para iris Wecker	75	Tohoku pinza de campo	132
tijera de diseccion Lexer	53	tijera para ligadura Heath	66	tonometro Schioetz	394/2
tijera de diseccion Lexer Baby	53	tijera para ligadura Littauer	66	Took cuchillo corneal	373
tijera de diseccion Mayo	52/1	tijera para ligadura Spencer	66	torniquete pneumatico	295
tijera de diseccion Mayo-Noble	52/1	tijera para ligaduras Wavecut	54	tournique Belmont-Rumel	528
tijera de diseccion Mayo-Stille	52/1	tijera para neurocirugia	65	tournique Rumel-Belmont	528
tijera de diseccion Metzenbaum	53/1	tijera para neurocirugia Strully	65	Townley calibre	26
tijera de diseccion Noble-Mayo	52/1	tijera para oftalmologia	57, 75, 79	Townsend pinza para biopsia	591
tijera de diseccion Stille-Mayo	52/1	tijera para oftalmologia Barraquer Colibri	75	Townsend-Down-Mini pinza para biopsia	591
tijera de diseccion Weller	53/2	tijera para oftalmologia Colibri Barraquer	75	Townsend-Up-Mini pinza para biopsia	591
tijera de incision	52	tijera para oftalmologia Gradle	57	Toybee especulo auricular	399
tijera DeBakey	60	tijera para parametrium	63	tractor Bill	604
tijera duramadre Schmieden-Taylor	65/1	tijera para preparacion	65	tractor Bill-Luikart	604
tijera duramadre Taylor-Schmieden	65/1	tijera para rinoplastia Fomon	65/1	tractor Luikart-Bill	604
tijera Enuclation	58	tijera para septo Killian	471	transformador para mango de pila	
tijera face lift Freeman	73	tijera para tendon Westcott	75	para laringoscopio	34
tijera face lift Gorney	73	tijera para tenotomia Stevens	58	Travers separador	172
tijera face lift Joseph Peck	73	tijera para uñas	609, 614	trefina para aorta	528
tijera face lift Kaye	73	tijera para vasija Klinkenbergh-Loth	65/2	trepano Keyes	698
tijera face lift Peck Joseph	73	tijera para vasija Loth-Klinkenbergh	65/2	Trethowan Lane elevador	200
tijera face lift Rees	73	tijera para vendaje	69/1, 69/2, 70	trocar abdominal Nelson (Standard)	204
tijera ginecologica Doyen	63	tijera para vendaje Bergmann	69/1	trocar abdominal Standard (Nelson)	204
tijera ginecologica Dubois	63	tijera para vendaje Bruns	70	trocar Douglas	204
tijera ginecologica Siebold	62	tijera para vendaje Esmarch	69/2	trocar Nelson	205
tijera ginecologica Sims	62	tijera para vendaje Excenter Reda	69/2	trocar Ochsner	205
tijera ginecologica Wertheim	63	tijera para vendaje Knowles	70	trocar para seno maxilar Coakley	204
tijera Martin-Cartilage	65/1	tijera para vendaje Lister	69/1	trocar para seno maxilar Lichtwitz	204
tijera nasal	428, 429	tijera para vendaje Lorenz	70	trocar para seno maxilar Pierce	204
tijera nasal Cottle	59	tijera para vendaje Reda Excenter	69/2	trocar Universal	204
tijera nasal Fomon	58	tijera para vendaje Seutin	69/2	Troeltsch (Wilde) pinza auricular	410
tijera nasal Fomon	58	tijera para vendaje Universal	70	Troeltsch pinza nasal	424
tijera nasal Watson-Williams	428	tijera para vesicula biliar Thorex	65/2	Troemner martillo de percusion	24
tijera nasal Williams-Watson	428	tijera pulmonares Crafoord	65/2	Trousseau-Baby dilatador traqueal	476
tijera Northbent	66	tijera Strabismus	58	Troutman (Colibri) pinza para iris	384
tijera para alambre y laminas Universal	67	tijera supercut	71, 72	Troutman pinza para iris	389
tijera para amigdalas	59	tijera supercut Baby Metzenbaum	71	Tübingen Mod. pinza para ligadura	392
tijera para amigdalas Boettcher	59	tijera supercut Iris	72	Tübingen Mod. pinza para sutura	386
tijera para amigdalas Dean	59	tijera supercut Kilner/Ragnell	72	Tübingen pinza para ligadura	392
tijera para amigdalas Good	59	tijera supercut La Grange	72	Tübingen pinza para sutura	386
tijera para capsula Resano	53/2	tijera supercut Lister	72	tubo de aspiracion	27, 28, 337, 337/2, 338
tijera para cartilago McIndoe	65/1	tijera supercut Mayo	71	tubo de aspiracion Adson	337
tijera para cirugia Cottle	56	tijera supercut Mayo-Stille	71	tubo de aspiracion Andrew-Pynchon	28
tijera para cirugia Graeffe	56	tijera supercut Metzenbaum	71	tubo de aspiracion Baby-Yankauer	27
tijera para cirugia Iris	54/2	tijera supercut Ragnell/Kilner	72	tubo de aspiracion Fergusson	337
tijera para cirugia Joseph	54/1	tijera supercut Reynolds	72	tubo de aspiracion Fergusson/Frazier	337
tijera para cirugia Kilner	54/1	tijera supercut Stevens	72	tubo de aspiracion Frazier/Fergusson	337
tijera para cirugia Knapp	55	tijera supercut Stille-Mayo	71	tubo de aspiracion House	337/2
tijera para cirugia Littler	55	tijera supercut Wagner	72	tubo de aspiracion Plester	338
tijera para cirugia Metzenbaum	54	tijera Toennis-Adson	65	tubo de aspiracion Poole	27
tijera para cirugia Reynolds	54/1	tijera vascular	59-61	tubo de aspiracion Pynchon-Andrew	28
tijera para cirugia Sanvenero	54/1	tijera vascular DeBakey	61	tubo de aspiracion Rosen	338
tijera para cirugia Standard	51	tijera vascular DeMartel-Potts	59	tubo de aspiracion Yankauer	27
tijera para cirugia Systtrunk	66	tijera vascular Dietrich	60	tubo de aspiracion Yankauer-Baby	27
tijera para cirugia Waldmann	64	tijera vascular Favalaro	61	tubo de aspiracion Yankauer-Baby	27

tubo de aspiracion Yasargil.....	337/1
tubo de extension Bruenings.....	472
Tubulus. gerade, einfach.....	267
Tucker-Luikart-McLearn forceps obstetrico.....	603/1
Tuffier pinza hemostatica.....	110
Tuffier separador.....	147
Tuffier separador costal.....	487
Turnbull alicate para cortar uñas.....	609
Tyding amigdalotomo.....	469
Tyding pinza para coger amigdalas.....	468

U

U.S. Kirschner estribo para extension.....	312
Uckermann porta-algodon.....	203
Ulrich pinza para hueso.....	248
Ulrich pinza para tapones.....	135
Uni I estuche de diagnostico / otoscopio.....	13
Uni II estuche de diagnostico/ oftalmoscopio May.....	14
Uni III estuche de diagnostico.....	15
Universal pinza para esterilizacion.....	227
Universal tijera para alambre y laminas.....	67
Universal tijera para vendaje.....	70
Universal trocar.....	204
Unna saca comedones.....	608
Up-Mini-Townsend pinza para biopsia.....	591
Up-Tischler pinza para biopsia.....	591
uretrotomo Otis.....	553
Us Army / Parker-Longenbeck separador.....	141
Us Army Smith tijera para gaza.....	69/1
USA Mod. tijera para cordon umbilical.....	64

V

Valleix histerometro.....	586
Van Buren bujia dilatadora.....	554
Van Buren pinza para secuestros.....	249
Van Doren pinza para biopsia.....	588
Vannas tijera para iridectomia.....	79
Varady instrumento para varices.....	202
vasos graduados.....	621
vendaje de compresion Esmarch.....	296
Verbrugge pinza para hueso.....	245
Verbrugge-Müller elevador.....	286/2
Vernet-Gil separador.....	152
VIENNA Captador de hilos.....	221/1
Vienna especulo nasal.....	421
Vienna Mod. especulo nasal.....	421
Virchow cuchillo para autopsia.....	48
Virchow cuchillo para cerebro.....	48
Volkmann cucharilla cortante.....	251, 257
Volkmann separador.....	153-156
Voltolini especulo nasal.....	421
Voss-Krause polipotomo.....	433/2
Vu-More especulo vaginal.....	569

W

Wachenfeldt pinza para aplicar agrafes.....	224
Wadsworth-Todd cauterio.....	378
Wagener gancho abotonado.....	409
Wagener-Mosher canula para traqueotomia.....	477
Wagner pinza cortante para laminectomia.....	343
Wagner tijera.....	67
Wagner tijera supercut.....	72
Waldmann tijera para cirugia.....	64
Walker-Thomson separador vesical.....	552
Wallich cucharilla para aborto.....	607
Walsham pinza para enderezar el tabique nasal.....	449
Walther cateter.....	555
Walther sonda metalica.....	555
Walton gubia para cuerpos extraños.....	374
Walton saca comedones.....	608
Walton sierra para abrir anillos.....	297

Wangensteen pinza de diseccion.....	89
Wangensteen porta aguja.....	210
Wartenberg sensimetro.....	25
Watson dermatomo.....	50
Watson-Cheyne disecador.....	199
Watson-Cheyne elevador.....	283
Watson-Williams pinza nasal.....	428
Watt-Stone manguito de cierre.....	545
Watt-Stone pinza intestinal.....	545
Waugh pinza de diseccion.....	83
Wavecut tijera para ligaduras.....	54
Weber asa.....	378
Weber pinza para la aorta.....	501
Webster porta aguja.....	208
Wecker espátula para iris.....	378
Wecker tijera para iris.....	75
Week blefarostato.....	370
Weil-Blakesley pinza nasal.....	426
Weiss-Dupuy aguja para sutura amigdalas.....	466
Weitlaner separador.....	169
Weitlaner-Wullstein separador.....	169
Weller tijera de diseccion.....	532
Wells espátula para enucleacion.....	378
Wells-Spencer pinza hemostatica.....	109
Wertheim pinza para histerectomia.....	124, 128
Wertheim tijera ginecologica.....	63
Wertheim-Cullen pinza para histerectomia.....	125
West cincel nasal.....	442/1
Westcott tijera para tendon.....	75
Westmacott pinza nasal.....	424
Wheeler cuchillo para discision.....	373
White pinza para coger amigdalas.....	467
Wieder baja-lengua.....	452
Wiener escofina nasal.....	443
Wiener gancho para iris.....	375
Wigmore cuchillo para vendajes enyesados.....	229
Wikstroem pinza hemostatica.....	117
Wilde (Troeltsch) pinza auricular.....	410
Wilde cierra-nudo auricular.....	411
Wilde polipotomo.....	433/2
Wilder asa.....	378
Wilder dilatador lacrimal.....	381
Williams destornillador.....	323
Willet Martel pinza hemostatica.....	110
Williams blefarostato.....	370
Williams pinza para tejido.....	539
Williams-Watson pinza nasal.....	428
Williger cucharilla cortante.....	255, 257
Williger martillo.....	271
Williger periostotomo.....	276
Winter pinza para aborto.....	606
Wittner pinza para biopsia.....	589
Wolff pinza para arrancar vendaje enyesado.....	233
Wolfson-DeMartel pinza para anastomosis.....	546
Wolfson-DeMartel pinza para cerrar clamps.....	546
Wolfson-DeMartel porta-clamps.....	546
Wood-Crile porta aguja.....	209
Woodson elevador para duramadre.....	333
Worst sonda lacrimal.....	381
Wrigley forceps obstetrico.....	602
Wullstein cuchillo.....	418
Wullstein mango de aspiracion.....	338
Wullstein pinza auricular micro.....	416
Wullstein separador.....	171
Wullstein-Hartmann pinza para polipos.....	412
Wullstein-Weitlaner separador.....	169
Wylye pinza para la aorta.....	501/1, 501/2

Y

Yancoskie separador.....	198
Yankauer tubo de aspiracion.....	27
Yankauer-Baby tubo de aspiracion.....	27
Yasargil gancho para galea.....	330

Yasargil pinza para tumores.....	97
Yasargil tubo de aspiracion.....	337/1
Yeoman cierra-nudo rectal.....	566
Yeoman pinza para biopsia rectal.....	566
Young pinza de agarre para prostata.....	550
Young pinza tira-lengua.....	453
Young separador prostatico.....	550

Z

Zaufal elevador auricular.....	409
Zaufal-Jansen elevador auricular.....	409
Zaufal-Jansen pinza gubia.....	238
Zenker pinza hemostatica.....	118
Zenker separador.....	161
Ziegler cuchillo para discision.....	373
Ziegler cuchillo para iris.....	372
Zielke gubia.....	264

A

ABBASSALINGUA 451
 ABBASSALINGUA, DAVIS-BOYLE 455
 ABBASSALINGUA, DOUGHTY 458
 ABBASSALINGUA, DOYEN 451
 ABBASSALINGUA, RUSSEL-DAVIS 458
 ABBASSALINGUA, ANDREW 452
 ABBASSALINGUA, BRUENINGS 451
 ABBASSALINGUA, BUCHWALD 451
 ABBASSALINGUA, DINGMANN 456
 ABBASSALINGUA, FRENZEL 451
 ABBASSALINGUA, HARTMANN 452
 ABBASSALINGUA, KILNER-DOUGHTY 456
 ABBASSALINGUA, KROENIG 451
 ABBASSALINGUA, MAYO 451
 ABBASSALINGUA, MORITZ-SCHMIDT 452
 ABBASSALINGUA, TOBOLD 453
 ABBASSALINGUA, WIEDER 452
 ABRAHAM, COLTELLO PER TONSILLE 466
 ABRAHAM, PINZA PER TONSILLE 468
 ACCESSORI DI FISSAZIONE, ANELLI E BARRE 195
 ACCESSORI PER SEGA PER AUTOPSIA 231/2, 231/3
 ADENOIDECTOMIA - TONSILLECTOMIA, DRAFFIN 459
 ADENOIDECTOMIA - TONSILLECTOMIA, MAGAURAN 459
 ADENOTOMO LA FORCE 450
 ADLERKREUTZ, PINZA VASCOLARE 84
 ADSON BABY, PINZA EMOSTATICA 113
 ADSON, DIVARICATORE 173
 ADSON, DIVARICATORE 172
 ADSON, MICRO PINZA ANATOMICA 82
 ADSON MICRO PINZA CHIRURGICA 82
 ADSON, PERIOTOTOMO 282
 ADSON, PINZA ANATOMICA 82
 ADSON, PINZA ANATOMICA 82
 ADSON, PINZA CHIRURGICA 82
 ADSON, PINZA EMOSTATICA 112
 ADSON, PINZA PER IPOFISI 334
 ADSON, PINZA SGORBIA 236
 ADSON, PORT'AGHI 211
 ADSON, TENAGLIA PER OSSA 298
 ADSON TUBO D'ASPIRAZIONE 337
 ADSON UNCINO PER DURAMADRE 329
 ADSON, DIVARICATORE 174
 ADSON-BROWN, PINZA CHIRURGICA 82
 AGHI PER SUTURE 222, 223
 AGO DI GUIDA, IOWA 206
 AGO DI GUIDA, REDON 207
 AGO DI INTRODUZIONE, OBWEGESER 463
 AGO DI INTRODUZIONE, OBWEGESER 463/3
 AGO PASSAFILI, DEMEL 315
 AGO PER BIOPSIA, FRANKLIN-SILVER 206
 AGO PER CORPI ESTRANEI 374
 AGO PER CORPI ESTRANEI, FRANCIS 374
 AGO PER CORPI ESTRANEI, LA FORCE 374
 AGO PER DISCISIONE 374
 AGO PER DISCISIONE, BOWMAN 374
 AGO PER LEGATURE 218
 AGO PER LEGATURE SCHMIEDEN-DICK 219
 AGO PER LEGATURE, COOPER 219
 AGO PER LEGATURE, DESCHAMPS 218
 AGO PER LEGATURE, KRONECKER 219
 AGO PER PARACENTESI, LUCAE 408
 AGO PER PARACENTESI, POLITZER 408
 AGO PER TONSILLE 470
 AGO PER TONSILLE, CLAUD 466
 AGO PER TONSILLE, DUPUY-WEISS 466
 AGO PER TONSILLE, NAGER 466
 AGO POST MORTEM 268
 AGO, BARBARA 419
 AGO, KEITH 223
 AGO, KOENIG 223
 AGO, REVERDIN 220

AGO, ROSEN 419
 AGRAFES, MICHEL 224
 ALAN-PARKS, DIVARICATORE ANALE 561
 ALDERDYCE ELEVATORE 282
 ALESATORE PER FEMORE, KUENTSCHER 321
 ALESATORE PER L'APERTURA DEL MIDOLLO KUENTSCHER 321
 ALEXANDER, PERIOTOTOMO 276
 ALEXANDER, PINZA PER BIOPSIA 589
 ALEXANDER, SCALPELLO 259
 ALEXANDER, SGORBIA 259
 ALGESIMETRO, WARTENBERG 25
 ALLEN, PINZA PER L'APPENDICE 544
 ALLIS, PINZA PER AFFERRARE INTESTINI 537
 ALLIS-ADAIR, PINZA PER AFFERRARE INTESTINI 537
 ALLIS-BABY, PINZA PER AFFERRARE INTESTINI 537
 ALLISON, SPATOLA PER POLMONE 489
 ALM, DIVARICATORE 168
 ALVIS, CURETTA PER CORPI ESTRANEI 374
 AMNIOTOMO, BEACHAM 586
 ANDERSON ADSON DIVARICATORE 172
 ANDREW, ABBASSALINGUA 452
 ANDREW-PYNCHON TUBO D'ASPIRAZIONE 28
 ANELLI DI GOMMA PER LEGATURA 568
 ANOSCOPIO, HIRSCHMANN 562
 ANSA AURICOLARE, BILLEAU 409
 ANSA AURICOLARE, SHAPLEIGH 410
 ANSA PER CATERATTA, SNELLEN 378
 ANSA PER CATERATTA, WEBER 378
 ANSA PER CATERATTA, WILDER 378
 ANSA PER POLIPI 411
 ANSE PER TONSILLE 468
 ANTRUM-CURETTA 435
 ANVIL TRONCHESINA PER UNGHIE 613
 APPROSSIMATORE COSTALE, BAILEY 489
 APPROSSIMATORE COSTALE, BAILEY-BABY 489
 APPROSSIMATORE COSTALE, BAILEY-GIBBON 489
 APPROSSIMATORE, BIEMER-MÜLLER 363
 APRIBOCCA DI LEGNO MAUNDER 459
 APRIBOCCA, DAVIS-BOYLE 455
 APRIBOCCA, DAVIS-MEYER 457
 APRIBOCCA, DENHART, 12CM 454
 APRIBOCCA, DINGMANN 456
 APRIBOCCA, HEISTER 454
 APRIBOCCA, JENNINGS 454
 APRIBOCCA, KILNER-DOUGHTY 456
 APRIBOCCA, MCIVOR 457
 APRIBOCCA, ROSER-KOENIG 16CM 454
 APRIBOCCA, DOYEN-JANSEN(MOLT) 454
 ARCHER, PINZA PER SCHEGGE 92
 ARCO, PER ESTENSIONE, BOEHLER 312
 ARCO, PER ESTENSIONE, KIRSCHNER 312
 ARCO, PER ESTENSIONE, KIRSCHNER US 312
 ARRUGA, BLEFAROSTATO 370
 ARRUGA, PINZA CAPSULARE 391
 ARRUGA, PORT'AGHI 214
 ASCH, PINZA PER LA PLASTICA NASALE 449
 AUFRANC-COBRA, DIVARICATORE 289
 AUFRICHT, RASPA NASALE 443
 AUFRICHT, UNCINO NASALE 447
 AUVARD, SPECULO VAGINALE 576
 AYER PINZA PER CALAZIO 393

B

BABCOCK, PINZA PER AFFERRARE INTESTINI 539
 BABINSKI MARTELLO DA PERCUSSIONE 24
 BABY BURKE, PINZA PER BIOPSIA 590
 BABY GOSSET, DIVARICATORE ADDOMINALE 181
 BABY METZENBAUM, SUPERCUT FORBICI 71
 BABY TISCHLER, PINZA PER BIOPSIA 592
 BABY WEBSTER, PORT'AGHI 208
 BABY YANKAUER, CANNULA D'ASPIRAZIONE 27
 BABY-KOCHER, PINZA INTESTINALE 540

BABY-OLSEN-HEGAR, PORT'AGHI 212
 BACINELLA 619, 620
 BACINELLA, PER PLACENTA 621
 BACINELLA, RENIFORMA 619
 BACKHAUS, PINZA FISSATELI 132
 BAILEY, APPROSSIMATORE COSTALE 489
 BAILEY-BABY, APPROSSIMATORE COSTALE 489
 BAILEY-GIBBON, APPROSSIMATORE COSTALE 489
 BAINBRIDGE, PINZA EMOSTATICA 119/2
 BAINBRIDGE, PINZA VASCOLARE 495/1-495/2
 BAKES, DILATATORE BILIARE 532
 BALFOUR BABY, DIVARICATORE ADDOMINALE 182
 BALFOUR, DIVARICATORE ADDOMINALE 182
 BALFOUR, DIVARICATORE ADDOMINALE 183
 BALFOUR-US, DIVARICATORE ADDOMINALE 184
 BALL AND SOCKET PINZA FISSATELI 133
 BALLENGER, COLTELLO PER SETTO 436
 BALLENGER, ELEVATORE PER SETTO 439
 BALLENGER, PINZA PER TONSILLE 467
 BANE-HARTMANN, PINZA SGORBIA 237
 BARACANI, INSERTO 472
 BARBARA, AGO 419
 BARBARA, UNCINO 419
 BARNHILL, COLTELLO ADENOIDE 450
 BARON, CANNULA D'ASPIRAZIONE 336
 BARR SPECULO RETTALE 559
 BARRAQUER (COLIBRI), PINZA PER IRIDE 384
 BARRAQUER, BLEFAROSTATO 370
 BARRAQUER, COLTELLO PER CHERATOPLASTICA 373
 BARRAQUER, FORBICI OCULISTICHE 75
 BARRAQUER, PINZA DA FISSAZIONE 390
 BARRAQUER, PINZA DEPILETORIA 395
 BARRAQUER, PORT'AGHI 216, 217
 BARRAQUER-KATZIN, PINZA PER IRIDE 384
 BARRAQUER-TROUTMAN, PORT'AGHI 216
 BARRET, PINZA PER ABBASSARE IL COLLO DELL'UTERO 582
 BARRON, MANICI PER LAMA BISTURI 38
 BAUMGARTNER, PORT'AGHI 208
 BEACHAM, AMNIOTOMO 586
 BECK, PINZA PER ANASTOMOSI 520
 BECK, PINZA VASCOLARI 516
 BECKER, CISTOTOMO 375
 BECKMANN, COLTELLO ADENOIDE 450
 BECKMANN, DIVARICATORE 176
 BECKMANN-ADSON, DIVARICATORE 175
 BECKMANN-EATON, DIVARICATORE 176
 BEEBEE, FORBICI PER CORONA 68
 BEER, PINZA DEPILETORIA 395
 BEESON, DIVARICATORE PER GESSI 232
 BEESON, DIVARICATORE PER GESSI 232
 BELLUCCI, MICRO FORBICI AURICOLARI 413
 BELLUCCI, MICRO FORBICINE 417
 BENDA, PER COMPRESSIONE ESMARCH 297
 BENDER, MODELLATORE PER CHIODI 322
 BENGOLEA, PINZA EMOSTATICA 112
 BENNETT, ELEVATORE PER OSSA 283
 BENSANDE, PROCTOSCOPIO 565
 BENSON, DIVARICATORE PER PILOLO 544
 BERENS, CHERATOMO 372
 BERGMANN, FORBICI PER BENDAGGI 69/1
 BERGMANN, MARTELLO 272
 BERKE, PINZA MUSCOLARE 389
 BERLINER, MARTELLO DA PERCUSSIONE 24
 BERNHARD, PINZA FISSATELI 133
 BERRY, PINZA TORCIFILI 319
 BETHUNE, COSTOTOMO 481
 BICCHIERE, GRADUATO 620
 BICCHIERE, PER MEDICINALI 621
 BIEMER, CLIPS PER VASI 361
 BIEMER, PINZA POSA CLIPS 361, 363, 364, 366
 BIEMER-MÜLLER, APPROSSIMATORE 363
 BIER SEGA PER AMPUTAZIONE 296
 BILL TRATTORE 604

BILLEAU, ANSA AURICOLARE	409	BRUENINGS, PINZA PER SETTO NASALE.....	425	CANNULA PER IRRIGAZIONE, SIEBENMANN	433
BIPOLARI SOTTILE FORBICI	634	BRUENINGS, SPECOLO AURICOLARE	401	CANNULA PER IRRIGAZIONE, SIMCOE	394
BIPOLARI STANDARD FORBICI	634	BRUNETTI, SCALPELLO	268	CANNULA TRACHEALE, LUER	479
BIRCHER-GANSKE, TENAGLIA PER OSSA.....	246	BRÜNNINGS-LUCAS, SCALPELLO	260	CANNULA TRACHEALE, WAGENER-MOSHER.....	477
BIRKETT PINZA EMOSTATICA	116	BRÜNNINGS-LUCAS, SCALPELLO	260	CANNULA TRACHEALE, CHEVALIER-JACK	479
BISHOP-HARMAN, PINZA PER IRIDE.....	386	BRÜNNINGS-LUCAS, SGORBIA	260	CANNULA, LICHTWITZ.....	433
BISHOP-HARMON CANNULA OCULISTICA PER IRRIGAZIONE ED ASPIRAZIONE	394/1	BRUNNER, COSTOTOMO	481	CAPLAN, PINZA NASALE	428
BISTURI MONOUSO, STERILI	43	BRUNNER, DIVARICATORE	167	CARICABATTERIE PER MANIGLIE DI.....	33
BISTURI, MANICO DI METALLO	46	BRUNNER, PINZA INTESTINALE	543	CARMALT, PINZA PER SCHEGGE	91
BLAKE, CURETTA UTERINA	595	BRUNNER, SONDE CONDUTTRICE	221/1	CAROLL, PINZA PER AFFERRARE TENDINI	293
BLAKE, PINZA PER CALCOLI BILIARI	531	BRUNS, CURETTA TAGLIANTE	251, 254	CARPENTER, COLTELLO PER TONSILLE	465
BLEFAROSTATO, CLARK	370	BRUNS, FORBICI PER BENDAGGI	70	CASPAR, DIVARICATORE PER SPINA CERVICALE.....	179
BLEFAROSTATO, LIEBERMANN	371	BRYANT, PINZA PER MEDICATURA	137	CASPAR, DIVARICATORE PER SPINA CERVICALE.....	180
BLEFAROSTATO, ARRUGA	370	BUCHWALD, ABBASSALINGUA	451	CASPAR, PISTONI	528
BLEFAROSTATO, BARRAQUER	370	BUCK, CURETTA AURICOLARE	407	CASTANEDA NEONATAL, PINZA VASCOLARE	257
BLEFAROSTATO, BOWMAN	370	BUCK, LEVA PER CORPI ESTRANEI	412	CASTROVIEJO, BLEFAROSTATO	371
BLEFAROSTATO, CASTROVIEJO	371	BUCK, MARTELLO DA PERCUSSIONE	24	CASTROVIEJO, COMPASSO	370
BLEFAROSTATO, GRAEFE	370	BUCK-GRAMCKO, ELEVATORE PER OSSA	285	CASTROVIEJO, FORBICI CORNEALI	79
BLEFAROSTATO, LANCASTER	371	BUJE CANNULA D'ASPIRAZIONE RETTALE	566	CASTROVIEJO, PINZA CAPSULARE	391
BLEFAROSTATO, MELLINGER	370	BULLDOG, PINZA MINI DIETRICH.....	101	CASTROVIEJO, PINZA FISSATRICE	390
BLEFAROSTATO, MUELLER	371	BULLDOG, PINZA, JOHNS-HOPKINS	104	CASTROVIEJO, PINZA PER SUTURA	392
BLEFAROSTATO, MURDOCK	370	BULLDOG, PINZE ATRAUMATICHE	100	CASTROVIEJO, PORT'AGHI	215
BLEFAROSTATO, PARK	371	BÜLOW-GUNAR-HEY, PINZA SERRATUBI A RULLI	130	CASTROVIEJO, ROMPILAMETTE	45
BLEFAROSTATO, STEVENSON	371	BUMM, CURETTE UTERINI	597	CASTROVIEJO, SPATOLA PER CICLODIALISI	379
BLEFAROSTATO, WEEK	370	BUNELL ENUCLEATORE PER TENDINI	292	CASTROVIEJO-MICRO, PORT'AGHI	216
BLEFAROSTATO, WILLIAMS	370	BUNELL GUIDA PER TENDINI	294	CASTROVIEJO-STANDARD, PORT'AGHI	215
BLOHMKE, PINZA PER TONSILLE	467	BUNELL PERFORATORE A MANO.....	299	CATETERE AURICOLARE, HARTMANN	408
BLOUNT ELEVATORE PER GINOCCHIO	289	BUNGE, CUCCHIAIO PER ESTENTERAZIONE	378	CATETERE METALLICO	555
BLOUNT ELEVATORE PER OSSA	288	BUNT, PINZA PER STERILIZZAZIONE	227	CATETERE METALLICO, COXETER	555
BLUMENTHAL, PINZA SGORBIA	236	BURCH, UNCINO DI FISSAZIONE	373	CATLIN AMPUTAZIONSMESN	44
BODENHAMMER, SPECOLO RETTALE	559	BURKE, PINZA PER BIOPSIA	590	CAUTERIO, WADSWORTH-TODD	378
BOEHLER, ARCO PER ESTENSIONE	312	BUSHE, CURETTA TAGLIANTE	256	CAVI DI COLLEGAMENTO BIPOLARI.....	633
BOETTCHER FORBICI PER TONSILLE.....	59			CAVO BIPOLARE	633
BÖHLER CESOIA PER OSSA	241			CESOIA PER GESSI, STILLE	229
BÖHLER, PINZA SGORBIA	238			CESOIA PER OSSA, STILLE-HORSLEY	242
BOIES ELEVATORE	277			CESOIA PER OSSA, STILLE-LISTON	242
BONACCOLTO, PINZA PER STRABISMO	385			CESOIA PER OSSA, BOEHLER	241
BONN, PINZA PER IRIDE	387			CESOIA PER OSSA, LISTON	241
BONNEY, PINZA ANATOMICA	88			CESOIA PER OSSA, MCINDOE	241
BONNEY, PINZA CHIRURGICA.....	88			CESOIA PER OSSA, RUSKIN-LISTON	241
BOSE, DIVARICATORE TRACHEALE	476			CESOIA PER OSSA, SEMB	242
BOUCHERON, SPECOLO AURICOLARE	399			CESOIA PER OSSA, COTTLE-K	241
BOWMAN, AGO PER DISCISIONE	374			CESTELLO PER STERILIZZAZIONE	622
BOWMAN, BLEFAROSTATO	370			CHANDLER ELEVATORE	282
BOWMAN, CHERATOMO	372			CHAPUT, PINZA PER AFFERRARE TESSUTI	110
BOWMAN, SPECILLO PER CANALE LACRIMALE	381			CHARNLEY, DIVARICATORE ADDOMINALE	289
BOYNTON, PORT'AGHI	214			CHARRIERE SEGA PER AMPUTAZIONE	296
BOZEMANN, PINZA PER TAMPONI	138			CHEATLE, PINZA PER STERILIZZAZIONE	227
BOZEMANN, PORT'AGHI	211			CHELSEA-EATON, PROCTOSCOPO	563
BOZEMANN-DOUGLAS, PINZA PER TAMPONI	138			CHERON, PINZA PER MEDICATURA	137
BRACCIALE	295			CHERRY, DIVARICATORE PER LAMINECTOMIA	488
BRACCIO, PORTALARINGOSCOPIO KLEINSASSER	36			CHEVALIER-JACKSON, CANNULA TRACHEALE	479
BRAND, ENUCLEATORE PER TENDINI	294			CHEVALIER-JACKSON, PINZA PER BRONCO-ESOFAGOSOPIA.....	473
BRAND, STRUMENTI PER AFFERRARE TENDINI	293			CHIAVE	266
BRAUN, CRANIOCLASTO	607			CHIAVI	313
BRAUN, DEPRESSORE UTERINO	586			CHILDE, PINZA PER AGRAFES	224
BRAUN, PINZA PER ABBASSARE IL COLLO DELL'UTERO	582			CHIODI PER OSSA	309
BRAUN, UNCINO SPEZZATORE	607			CHIODI STEINMANN	307, 308
BRAUN-STADLER, FORBICI PER EPISIOTOMIA	64			CHRISTOPHE, PINZE EMOSTATICHE	107
BREAST, DIVARICATORE PER CHIRURGIA PLASTICA	198			CINELLI SCALPELLO PER SETTO	441
BREISKY, SPECOLO VAGINALE	577			CISTOTOMO, BECKER	375
BRIDGE, PINZA EMOSTATICA.....	116			CISTOTOMO, GRAEFE	375
BRISTOW, ELEVATORE PER OSSA	290			CITELLI PINZA TAGLIANTE PER SETTO NASALE	430
BRODIE, SPECILLO	199			CLAR LAMPADA FRONTALE	22
BROPHY, PINZA ANATOMICA	84			CLARK BLEFAROSTATO 8CM	370
BROPHY, PINZA CHIRURGICA.....	84			CLAUS AGO PER TONSILLE	466
BROWN, PINZA PER TESSUTI	83			CLAYMAN UNCINO	376
BROWN, PORT'AGHI	209			CLEVELAND, PINZA SGORBIA	235
BRUENINGS, ABBASSALINGUA	451			CLIPS PER VASI, BIEMER	361
BRUENINGS, COLTELLO PER TONSILLE	466			CLIPS PER VASI, MEHDORN	362
BRUENINGS, INSERTO	472			CLIPS PER VASI, MUELLER	364, 365
				CLOWARD, DIVARICATORE	178
				CLOWARD, DIVARICATORE	178

C

PER CORPI VERTEBRALI	339	COLTELLO PER TONSILLE, ABRAHAM	466	CRAFOORD PINZA EMOSTATICA	118
CLOWARD PINZA TAGLIENTE		COLTELO PER TONSILLE, BRUENINGS	466	CRAIG PINZA NASALE	426
PER LAMINECTOMIA	342	COLTELO PER TONSILLE, CANFIELD	466	CRANIOCLASTO, BRAUN	607
COAKLEY, ANTRUM CURETTA	449	COLTELO PER TONSILLE, CARPENTER	465	CREGO ELEVATORE	282
COAKLEY, TREQUARTO PER SENO MASCELLARE	204	COLTELO PER TONSILLE, FISHER	466	CRILE, DIVARICATORE	140
COBB, CURETTA	252	COLTELO, PLESTER	418	CRILE, PINZA EMOSTATICA	107
COBB, PERIOTOTOMO	280	COLTELO, ROSEN	418	CRILE, PORT'AGHI	213
COBB, SGORBIA	262	COLTELO, SCHUKNECHT	418	CRILE, UNCINO PER NERVI	328
COLCLOUGH, PINZA TAGLIENTE PER		COLTELO, TABB	418	CRILE-MURRAY, PORT'AGHI	209
DISCHI INTERVERTEBRALI	344/1	COLTELO, WULLSTEIN	418	CRILE-RANKIN, PINZA EMOSTATICA	107
COLLER-CRILE, PINZA EMOSTATICA	106	COLUMELLA PINZA, COTTLE	448	CRILE-WOOD, PORT'AGHI	209
COLLIER PELVIMETRO	605	COLVER, PINZA PER TONSILLE	467	CRUTCHFIELD PERFORATORE	327
COLLIER PORTAGHI	208	COMBINAZIONE PER DIAGNOSTICA		CRUTCHFIELD PINZA PER TRAZIONE CRANIALE	327
COLLIN, COSTOTOMI	480	CON ILLUMINAZIONE ALOGENA, RI-MINI	17	CUCCHIAIO AURICOLARE, GROSS	409
COLLIN, DINAMOMETRO	25	COMBINAZIONE PER DIAGNOSTICA		CUCCHIAIO OSTETRICO, SELLHEIM	607
COLLIN, DIVARICATORE	139	CON ILLUMINAZIONE STANDARD ECO „T“	16	CUCCHIAIO PER ABORTO, CUZZI	606
COLLIN, DIVARICATORE ADDOMINALE	189/1	COMBINAZIONE PER DIAGNOSTICA		CUCCHIAIO PER ABORTO, WALLICH	607
COLLIN, DIVARICATORE ADDOMINALE	190	CON ILLUMINAZIONE STANDARD UNI I	13	CUCCHIAIO PER CALCOLI BILIARI, DESJARDINS	534
COLLIN, ISTEROMETRO	586	COMBINAZIONE PER DIAGNOSTICA		CUCCHIAIO PER CALCOLI BILIARI, FERGUSSON	533
COLLIN, LOKTITE DIVARICATORE ADDOMINALE	191	CON ILLUMINAZIONE STANDARD UNI II	14	CUCCHIAIO PER CALCOLI BILIARI, LUER-KOERTE	533
COLLIN, MARTELLO	270	COMBINAZIONE PER DIAGNOSTICA		CUCCHIAIO PER CALCOLI BILIARI, MAYO	534
COLLIN, PELVIMETRO	605	CON ILLUMINAZIONE STANDARD UNI III	15	CUCCHIAIO PER CATERATTA, DAVIEL	377
COLLIN, PINZA OMBELICALE	605	COMPASSO, CASTROVIEJO	380	CUCCHIAIO PER CATERATTA, GRAEFE	377
COLLIN, PINZA PER AFFERRARE INTESTINI	539	COMPASSO, IWANSON	227	CUCCHIAIO PER CATERATTA, KNAPP	378
COLLIN, PINZA PER AFFERRARE L'UTERO	585	COMPLETO	187/1	CUCCHIAIO PER ENUCELAZIONE, WELLS	378
COLLIN, PINZA PER AFFERRARE TESSUTI	110	COMPRESSORE, STONE-WATT	545	CUCCHIAIO PER ESTENTERAZIONE, BUNGE	378
COLLIN, PINZA PER AGRAFES	224	CONE PINZA PER CRANIOTOMIA	331	CUCCHIAIO PER MEDICINALI	621
COLLIN, PINZA PER MEDICATURA	137	CONVERSE COLTELLO NASALE	435	CUCCHIAIO PER SANGUE	268
COLLIN, PINZA TIRALINGUA	453	CONVERSE UNCINO NASALE	448	CUCCHIAIO UTERINO GOURDET	599
COLLIN SPECOLO VAGINALE	570	COOLEY, CANNULA D'ASPIRAZIONE	28	CUCCHIAIO UTERINO SCHROEDER	595
COLLIN-DUVAL, PINZA DA PRESA	85	COOLEY, DILATATORE	528	CUCCHIAIO UTERINO, SIMON	594
COLLIN-HARTMANN, DIVARICATORE	141	COOLEY, DIVARICATORE	148	CULLER SPATOLA PER IRIDE	378
COLTELLO ADENOIDE, BECKMANN	450	COOLEY, DIVARICATORE COSTALE	487	CURA DELLO STRUMENTO	626
COLTELLO ADENOIDE, BARNHILL	450	COOLEY, PINZA CARDIOVASCOLARE		CURETTA ANTRUM	435
COLTELLO ADENOIDE, ST CLAIR-THOMSON	450	ATRAUMATICA	518, 519, 522	CURETTA ANTRUM, COAKLEY	449
COLTELLO AURICOLARE, POLITZER	408	COOLEY, PINZA PER CATETERI	510	CURETTA AURICOLARE, BUCK	407
COLTELLO AURICOLARE, SEXTON	408	COOLEY-DERRA, PINZA PER ANASTOMOSI	519	CURETTA, COBB	252
COLTELLO FALCATO REDA	435	COOLEY-NEONATAL, DIVARICATORE COSTALE	485	CURETTA DA CALAZIO, HEBRA	377
COLTELLO INTEROSSEO	44	COOPER, AGO PER LEGATURE	219	CURETTA DA CALAZIO, MEYHOEFER	377
COLTELLO LANCEOLARE, BERENS	372	COPERCHIO PER PADELLA	621	CURETTA PER ABORTO, PESTALOZZA	606
COLTELLO LANCEOLARE, BOWMAN	372	CORDA DI TRAZIONE	201	CURETTA PER BIOPSIA ED ASPIRAZIONE	600
COLTELLO LANCEOLARE, JAEGER	372	CORDES INSERTO	472	CURETTA PER BIOPSIA, HEANY	587
COLTELLO LANCEOLARE, WHEELER	373	CORONAL BLOW DIVARICATORE		CURETTA PER BIOPSIA, KEVORKIAN	587
COLTELLO LANCEOLARE, ZIEGLER	373	PER CHIRURGIA PLASTICA	198	CURETTA PER BIOPSIA, MOD MÜNCHEN	587
COLTELLO NASALE, CONVERSE	435	ROWIN-HEGAR, PINZA TORCIFILO	319	CURETTA PER BIOPSIA, NOVAK	587
COLTELLO NASALE, COTTLE	435	CORYLLOS, COSTOTOMO	480	CURETTA PER BIOPSIA, RANDALL	587
COLTELLO PER AMPUTAZIONE LISTON	44	CORYLLOS, DIVARICATORE	166	CURETTA PER CORPI ESTRANEI ALVIS	374
COLTELLO PER AMPUTAZIONE, CATLIN	44	COS MIKRO-PINZA AURICOLARE	414	CURETTA PER IPOFISI	334
COLTELLO PER AMPUTAZIONE, LANGENBECK	44	COSCIALE	295	CURETTA PER LUPUS, FOX	608
COLTELLO PER AMPUTAZIONE, REDA	44	COSTOTOMI, COLLIN	480	CURETTA PER LUPUS, PIFFARD	608
COLTELLO PER CARTILAGINE E DISSEZIONE,		COSTOTOMO	480	CURETTA TAGLIENTE, BRUNS	251, 254
VIRCHOW	48	COSTOTOMO, BETHUNE	481	CURETTA TAGLIENTE DOPPIA, VOLKMANN	257
COLTELLO PER CARTILAGINI, LANGENBECK	47	COSTOTOMO, BRUNNER	481	CURETTA TAGLIENTE, VOLKMANN	251
COLTELLO PER CATARATTA, DEUTSCHMANN	371	COSTOTOMO, CORYLLOS	480	CURETTA TAGLIENTE, WILLIGER	255
COLTELLO PER CATARATTA, GRAEFE	371	COSTOTOMO, GIERTZ-STILLE	481	CURETTA TAGLIENTE, BUSHE	256
COLTELLO PER CERVELLO	48	COSTOTOMO, GLUCK	480	CURETTA TAGLIENTE, DAUBENSPECK	255
COLTELLO PER CHERATOPLASTICA, BARRAQUER	373	COSTOTOMO, SAUERBRUCH	481	CURETTA TAGLIENTE, HALLE	253
COLTELLO PER CHERATOPLASTICA, PAUFIQUE	373	COSTOTOMO, STILLE	480	CURETTA TAGLIENTE, JACOBSON	257
COLTELLO PER DURA MADRE, KOOS	335	COTTLE BULLDOG-FORBICI	56	CURETTA TAGLIENTE, JANSEN	257
COLTELLO PER FALANGI	44	COTTLE, COLTELLO NASALE	435	CURETTA TAGLIENTE, LEMPERT	256
COLTELLO PER GESSI, ESMARCH	233	COTTLE, COLUMELLA PINZA	448	CURETTA TAGLIENTE, MARTINI	257
COLTELLO PER GESSI, HOPKINS	233	COTTLE, ELEVATORE PER SETTO	439	CURETTA TAGLIENTE, SCHEDE	251
COLTELLO PER GESSI, REINER	233	COTTLE FORBICI NASALI	59	CURETTA TAGLIENTE, SCOVILLE	253
COLTELLO PER GESSI, WIGMORE	229	COTTLE, MARTELLO	273	CURETTA TAGLIENTE, SPINAL	253
COLTELLO PER GONIOTOMIA, SCHEIE	373	COTTLE, PINZA DA PRESA	407	CURETTA TAGLIENTE, SPRATT	251
COLTELLO PER IRIDE, DEAN	372	COTTLE, SCALPELLO PER SETTO	440	CURETTA, FAULKNER	449
COLTELLO PER IRIDE, ZIEGLER	372	COTTLE, SPECOLO NASALE	423	CURETTA, HOUSE	420
COLTELLO PER MENISCO, NEFF	292	COTTLE, UNCINO NASALE	447	CURETTE UTERINI, BLAKE	595
COLTELLO PER MENISCO, SMILLIE	292	COTTLE-JOSEPH, ELEVATORE PER SETTO	439	CURETTE UTERINI, BUMM	597
COLTELLO PER ORGANI	48	COTTLE-KAZANJIAN, CESCOIA PER OSSA	241	CURETTE UTERINI, RECAMIER	597
COLTELLO PER PERIOTOSTO CON RASCHINO	47	COTTLE-NEIVERT, UNCINO NASALE	448	CURETTE UTERINI, SIMS	597, 598
COLTELLO PER RESEZIONE	47	CRAFTER CATETERE METALLICO	555	CURETTE UTERINI, THOMAS	599
COLTELLO PER SETTO NASALE, FREER	434	CUSCOO-SELLORS, PINZA EMOSTATICA	119	CUSCO SPECOLO VAGINALE	570, 571
COLTELLO PER SETTO, BALLENGER	436	CRAFOORD FORBICI POLMONARE	65/2	CUSHING (TAYLOR), PINZA TC	87

CUSHING, DIVARICATORE.....	151
CUSHING, DIVARICATORE.....	152
CUSHING, DIVARICATORE.....	153
CUSHING, PERFORATORE.....	299
CUSHING, PINZA ANATOMICA.....	83
CUSHING, PINZA CHIRURGICA.....	83
CUSHING, PINZA TAGLIENTE PER LAMINECTOMIA.....	340
CUSHING, SPATOLA CEREBRALE.....	369
CUSHING, TRAPANO.....	298
CUSHING, UNCINO PER NERVI.....	328
CUZZI CUCCHIAIO PER ABORTO.....	606
CZERNY, PINZA PER ABBASSARE IL COLLO DELL'UTERO.....	584
CZERNY, SPECOLO RETTALE.....	559

D

DANDY, PINZA EMOSTATICA.....	109
DANDY, UNCINO PER NERVI.....	328
DARLING DIVARICATORE.....	178
DARTIGUES PINZA PER AFFERRARE L'UTERO.....	585
DASTOOR, PINZA PER STRABISMO.....	386
DAUBENSPECK, CURETTA TAGLIENTE.....	255
DAVIDSON(SCAPULA) DIVARICATORE.....	166
DAVIEL, CUCCHIAIO PER CATERATTA.....	377
DAVIS DURA, DISSETTORE.....	332
DAVIS, PINZA PER STERILIZZAZIONE.....	227
DAVIS, SPATOLA CEREBRALE.....	337
DAVIS-BOYLE, ABBASSALINGUA.....	455
DAVIS-BOYLE, APRIBOCCA.....	455
DAVIS-MEYER, APRIBOCCA.....	457
DAY UNCINO.....	409
DE BAKEY / GARRETT DILATATORE VASCOLARE.....	529
DE BAKEY, CANNULA D'ASPIRAZIONE.....	28
DE BAKEY, DIVARICATORE ADDOMINALE.....	189/1
DE BAKEY, DIVARICATORI COSTALI.....	485/1
DE BAKEY, PINZA VASCOLARE.....	493, 494, 495, 496, 497, 498, 499, 500, 505, 507, 508, 514, 515, 516, 517
DE BAKEY, PINZE ATRAUMATICHE BULLDOG.....	103
DE BAKEY, PINZE ATRAUMATICHE IN TITANIO.....	99
DE BAKEY, PORT'AGHI.....	210
DE BAKEY, SATINSKY PINZE PER DISSEZIONE E LEGATURE.....	504/1
DE BAKEY, PINZA ATRAUMATICA BULLDOG.....	100
DE BAKEY, PINZE ATRAUMATICHE.....	98
DE BAKEY-MIXTER, PINZE PER LEGATURE.....	499/2
DE LEE, FORCIPE.....	602
DE MARTEL, STRUMENTO CONDUTTRICE.....	330
DE MARTEL-WOLFSON, PINZA PER ANASTOMOSI.....	546-547
DEAN, COLTELLO PER IRIDE.....	372
DEAN, FORBICI PER TONSILLE.....	59
DEAVER, DIVARICATORE.....	145
DEAVER, FORBICI PER DISSEZIONE.....	52
DEAVER-GRIP, DIVARICATORE.....	146
DEBAKEY, FORBICI VASCOLARI.....	61
DEBAKEY, FORBICI VASCOLARI TC.....	60
DEBAKEY, PINZA PER ANASTOMOSI.....	505
DEBAKEY-BAHNSON, PINZA ANEURISMA.....	506
DEBAKEY-DIETRICH, MINI PINZA BULLDOG.....	101
DEBAKEY-MOSQUITO, PINZA EMOSTATICA.....	509
DEBAKEY-PEAN, PINZA EMOSTATICA.....	513
DEBAKEY-RANKIN, PINZA EMOSTATICA.....	512
DEBAKEY-SATINSKY, PINZA PER OCCLUSIONE TANGENZIALE.....	502
DEJERINE, MARTELLO DA PERCUSSIONE.....	24
DELEE, DIVARICATORE.....	574
DEMEL, AGO PASSAFILI.....	315
DEMEL, STRUMENTO TENDIFILI.....	315
DENHART, APRIBOCCA.....	454
DENIS- BROWNE, PINZE PER DISSEZIONE, CHIRURGICHE/ANATOMICHE.....	89
DENIS-BROWNE, DIVARICATORE ADDOMINALE.....	185

DEPRESSORE UTERINO, BRAUN.....	586
DEPRESSORE UTERINO, SIMS.....	586
DERF PORT'AGHI.....	208
DERMATOMO, HUMBY.....	50
DERMATOMO, SILVER.....	50
DERMATOMO, SCHINK.....	49
DERRA, PINZA CARDIOVASCOLARE ATRAUMATICA.....	515
D'ERRICO UNCINO PER NERVI.....	329/2
DESCHAMPS, AGO PER LEGATURE.....	218
DESJARDINS, CUCCHIAIO PER CALCOLI BILIARI.....	534
DESJARDINS, PINZA EMOSTATICA.....	121
DESJARDINS, PINZA PER CALCOLI BILIARI.....	531
DESJARDINS, SONDA PER CALCOLI BILIARI.....	532
DESMARRES, DIVARICATORE.....	151
DESMARRES, PINZA PER CALAZIO.....	393
DEUTSCHMANN, COLTELLO PER CATARATTA.....	371
DEVILBISS, PINZA PER CRANIOTOMIA.....	332
DIAPASON.....	403
DIAPASON, HARTMANN.....	403
DIAPASON, LUCAE.....	404
DIAPASON, REDA.....	403
DIAPASONN, RYDEL-SEIFFERT.....	404
DIFFENBACH, PINZA VASCOLARE.....	104
DIETER MIKRO-PINZA AURICOLARE.....	414
DIETRICH, FORBICI VASCOLARI.....	60
DIETRICH, PINZA AORTA.....	510
DIETRICH, PINZA MINI BULLDOG.....	101
DILATATOR TRACHEALE LABORDE.....	476
DILATATORE, COOLEY.....	528
DILATATORE PER CANALE LACRIMALE, CASTROVIEJO.....	381
DILATATORE PER CANALE LACRIMALE, WILDER.....	381
DILATATORE PER CONDOTTI BILIARE, BAKES.....	532
DILATATORE PER SENO FRONTALE RITTER-HALLE.....	433
DILATATORE TRACHEALE, TROUSSEAU-BABY.....	476
DILATATORE TRACHEALE, TROUSSEAU.....	476
DILATATORE TUBBS.....	528
DILATATORE UTERINO GOODSELL.....	581
DILATATORE UTERINO, HANK.....	580
DILATATORE UTERINO, HEGAR.....	578, 579
DILATATORE UTERINO, PRATT.....	580
DILATATORE VASCOLARE, DE BAKEY / GARRETT.....	529
DINAMOMETRO, COLLIN.....	25
DINGMAN, ELEVATORE.....	463/3
DINGMANN, ABBASSALINGUA.....	456
DINGMANN, APRIBOCCA.....	456
DINGMANN, DIVARICATORE.....	463
DINGMANN, PERIOSTOTOMO.....	463
DINGMANN, TENAGLIA PER OSSA.....	246
DISSETTORE CORNEALE, PATON.....	373
DISPOSITIVO ILLUMINATIVO PER MORGAN.....	565
DISSETTORE CORNEALE, GILL.....	373
DISSETTORE CORNEALE, GREEN.....	374
DISSETTORE CORNEALE, SATO.....	373
DISSETTORE CORNEALE, TOOK.....	373
DISSETTORE GORNEY.....	277
DISSETTORE PER SACCO LACRIMALE, LANG.....	378
DISSETTORE PER TONSILLE, HURD.....	465
DISSETTORE PER TONSILLE, LOPEZ-REINKE.....	465
DISSETTORE, FISCH.....	420
DISSETTORE, PENFIELD.....	333
DISTRIBUTORE PER PERFORATORI FILIFORME.....	310
DISTRIBUTORE PER SPAZZOLINI.....	611
DITTEL CANDELETTA DILATATRICE.....	554
DIVARICATORE.....	463/3
DIVARICATORE ADDOMINALE, BABY GOSSET.....	181
DIVARICATORE ADDOMINALE, BALFOUR.....	182
DIVARICATORE ADDOMINALE, BALFOUR.....	183
DIVARICATORE ADDOMINALE, BALFOUR BABY.....	182
DIVARICATORE ADDOMINALE, BALFOUR-US.....	184
DIVARICATORE ADDOMINALE, CHARNELY.....	289
DIVARICATORE ADDOMINALE, COLLIN.....	190

DIVARICATORE ADDOMINALE, COLLIN-LOKTTITE.....	191
DIVARICATORE ADDOMINALE COMPLETO, KIRSCHNER.....	187/1
DIVARICATORE ADDOMINALE, DENIS-BROWNE.....	185
DIVARICATORE ADDOMINALE, FRAZIER.....	181
DIVARICATORE ADDOMINALE, GELPI.....	189/2
DIVARICATORE ADDOMINALE, GOSSET.....	181
DIVARICATORE ADDOMINALE, HORGAN.....	183
DIVARICATORE ADDOMINALE, JACKSON BURROWS.....	189/2
DIVARICATORE ADDOMINALE, KIRSCHNER.....	187
DIVARICATORE ADDOMINALE, RICARD.....	191
DIVARICATORE ADDOMINALE, RIGBY.....	189/2
DIVARICATORE ADDOMINALE, ROCHARD.....	186
DIVARICATORE ADDOMINALE, DE BAKEY.....	189/1
DIVARICATORE ADDOMINALE, DOYEN.....	189/1
DIVARICATORE ADDOMINALE, GELPI.....	189/1
DIVARICATORE ADDOMINALE, SET COMPLETO, CON MORSETTI E VALVE.....	193
DIVARICATORE ADDOMINALE, SET COMPLETO, CON SISTEMA DI MONTAGGIO.....	192
DIVARICATORE, ADSON.....	172
DIVARICATORE, ADSON.....	174
DIVARICATORE ANALE, SMITH-BUIE.....	561
DIVARICATORE AUFRANC-COBRA.....	289
DIVARICATORE, COLLIN.....	139
DIVARICATORE CON IMPUGNATURA A TREANGOLO, LANGENBECK-MANNERFELT.....	148/4
DIVARICATORE CON IMPUGNATURA A TREANGOLO MANNERFELT.....	148/3, 148/4, 148/5
DIVARICATORE COSTALE, COOLEY.....	487
DIVARICATORE COSTALE, COOLEY-NEONATAL.....	485
DIVARICATORE COSTALE, FINOCHIETTO-BURFORD.....	483
DIVARICATORE COSTALE, HAIGHT.....	487
DIVARICATORE COSTALE, MORSE.....	484
DIVARICATORE COSTALE, MORSE-FAVALORO.....	484
DIVARICATORE COSTALE, TUFFIER.....	487
DIVARICATORE, CUSHING.....	152
DIVARICATORE, CUSHING.....	153
DIVARICATORE DELEE.....	574
DIVARICATORE FINSEN.....	168
DIVARICATORE, HARRINGTON-PEMBERTON.....	147
DIVARICATORE, KIRSCHNER.....	187
DIVARICATORE, KOCHER.....	155
DIVARICATORE, KOCHER.....	159
DIVARICATORE, KOCHER.....	160
DIVARICATORE, KOCHER.....	163
DIVARICATORE, KÖNIG.....	153
DIVARICATORE, LANGENBECK.....	158
DIVARICATORE, LANGENBECK.....	159
DIVARICATORE, MARTIN.....	175/1
DIVARICATORE, MAYO-ADAMS.....	171
DIVARICATORE, MEYERDING.....	157
DIVARICATORE, MEYERDING.....	177
DIVARICATORE, NERFOLK-NORDWICH.....	172
DIVARICATORE, OBWEGESER.....	460, 461
DIVARICATORE PELVICO, ST MARKS.....	165
DIVARICATORE PER CHIRURGIA PLASTICA BREAST.....	198
DIVARICATORE PER CHIRURGIA PLASTICA CORONAL BLOW.....	198
DIVARICATORE PER CHIRURGIA PLASTICA, FERRIERA.....	197
DIVARICATORE PER CHIRURGIA PLASTICA, FREEMAN.....	198
DIVARICATORE PER CHIRURGIA PLASTICA, TEBBETTS.....	197
DIVARICATORE PER CHIRURGIA PLASTICA, YANCOCKIE.....	198
DIVARICATORE PER CORPI VERTEBRALI, CLOWARD.....	339
DIVARICATORE PER CORPI VERTEBRALI, INGE.....	339
DIVARICATORE PER GESSI, REDA.....	232

DIVARICATORE PER GESSI, BEESON	232
DIVARICATORE PER GESSI, HAGLUND-STILLE	232
DIVARICATORE PER GESSI, HENNIG	232
DIVARICATORE PER GUANCE, STERNBERG	453
DIVARICATORE PER LA PROSTATI, YOUNG	550
DIVARICATORE PER LABBRA	453
DIVARICATORE PER LAMINECTOMIA, SCOVILLE	196
DIVARICATORE PER LAMINECTOMIA SCOVILLE-HAVERFIELD	196
DIVARICATORE PER LAMINECTOMIA, CHERRY	488
DIVARICATORE PER MAMMARE	487/1
DIVARICATORE PER SPINA CERVICALE, CASPAR	179
DIVARICATORE PER SPINA CERVICALE, CASPAR	180
DIVARICATORE PER TIROIDE, SCHOENBORN	479
DIVARICATORE, PERKINS	168
DIVARICATORE, ROSE	140
DIVARICATORE, SAUERBRUCH	164
DIVARICATORE, SAUERBRUCH	166
DIVARICATORE, SCALP-CONTOUR	169
DIVARICATORE, SPINALE, TAYLOR	291
DIVARICATORE, STRANDELL-STILLE	157
DIVARICATORE, TESSIER	463/3
DIVARICATORE TRACHEALE	476
DIVARICATORE TRACHEALE, ITERSON	477
DIVARICATORE TRACHEALE, JACKSON	476
DIVARICATORE TRACHEALE, NEWS	477
DIVARICATORE, TRAVERS	172
DIVARICATORE, TUFFIER	147
DIVARICATORE VESCICALE, JUDD-MASSON	552
DIVARICATORE VESCICALE, LEGUE	553
DIVARICATORE VESCICALE, MILLIN	552
DIVARICATORE VESCICALE, MILLIN	553
DIVARICATORE VESCICALE, THOMSON-WALKER	552
DIVARICATORE, VOLKMANN	156
DIVARICATORE, WULLSTEIN	171
DIVARICATORE, ADSON	173
DIVARICATORE, ALM	168
DIVARICATORE, ANDERSON-ADSON	172
DIVARICATORE, BECKMANN	176
DIVARICATORE, BECKMANN-ADSON	175
DIVARICATORE, BECKMANN-EATON	176
DIVARICATORE, BRUNNER	167
DIVARICATORE, CLOWARD	178
DIVARICATORE, COLLIN HARTMANN	141
DIVARICATORE, COOLEY	148
DIVARICATORE, CORYLLOS	166
DIVARICATORE, CRILE	140
DIVARICATORE, CUSHING	151
DIVARICATORE, DARLING	178
DIVARICATORE, DAVIDSON (SCAPULA)	166
DIVARICATORE, DEEVER	145
DIVARICATORE, DEEVER GRIP	146
DIVARICATORE, DESMARRS	151
DIVARICATORE, DINGMANN	463
DIVARICATORE, DOYEN	163
DIVARICATORE, DOYEN-STILLE	167
DIVARICATORE, FARABEUF	139
DIVARICATORE, FRITSCH	163
DIVARICATORE, GIL-VERNET	152
DIVARICATORE, GOELET	141
DIVARICATORE, GREEN	160
DIVARICATORE, HARRINGTON	147
DIVARICATORE, HEANEY	164
DIVARICATORE, HENLEY	170
DIVARICATORE, HIBBS	164
DIVARICATORE, HOESEL	167
DIVARICATORE, HOFER	465
DIVARICATORE, HOLZHEIMER	168
DIVARICATORE, ISRAEL	162
DIVARICATORE, JANSEN	168
DIVARICATORE, KELLY	164
DIVARICATORE, KELLY GRIP	142
DIVARICATORE, KOCHER-LANGENBECK	159
DIVARICATORE, KOERTE	162

DIVARICATORE, LAHEY	157
DIVARICATORE, LITTLE	157
DIVARICATORE, LOVE	465
DIVARICATORE, MATHIEU	141
DIVARICATORE, MEYERDING	180
DIVARICATORE, MIDDELDORPF	160
DIVARICATORE, MIKULICZ	163
DIVARICATORE, MOLLISON	171
DIVARICATORE, MORRIS	164
DIVARICATORE, NAGER	465
DIVARICATORE, OLLIER	162
DIVARICATORE, PARKER	139
DIVARICATORE, PLESTER	171
DIVARICATORE, RAGNELL	140
DIVARICATORE, RAMUS	461
DIVARICATORE, RICHARDSON	142
DIVARICATORE, RICHARDSON GRIP	142
DIVARICATORE, RICHARDSON-EASTMAN	142
DIVARICATORE, ROUX	139
DIVARICATORE, ROUX-BABY	140
DIVARICATORE, ROUX-MINI	140
DIVARICATORE, SENN-GREEN	153
DIVARICATORE, SENN-MILLER	143
DIVARICATORE, SIMON	164
DIVARICATORE, SPINA-NASALIS	461
DIVARICATORE, VOLKMANN	153
DIVARICATORE, VOLKMANN	154
DIVARICATORE, WEITLANER	169
DIVARICATORE, WEITLANER-WULLSTEIN	169
DIVARICATORE, ZENKER	161
DIVARICATORE, US-ARMY PARKER-LANG	141
DIVARICATORI COSTALI	487/2
DIVARICATORI COSTALI, DE BAKEY	485/1
DIVARICATORI VESCICALI HRYNTSCHAK	553
DIVISORE PER CRANIO	267
DIX SGORBIA PER CORPI ESTRANEI	374
DIX STRUMENTI PER CORPI ESTRANEI	380
DOUGHTY ABBASSALINGUA	458
DOUGLAS PINZA DEPIULATORIA	395
DOYEN, ABBASSALINGUA	451
DOYEN, DIVARICATORE	163
DOYEN, DIVARICATORE ADDOMINALE	189/1
DOYEN, FORBICI GINECOLOGICHE	63
DOYEN, MARTELLI	271
DOYEN, PERIOSTOTOMO	278
DOYEN, PERIOSTOTOMO	278
DOYEN, PINZA FISSATELI	133
DOYEN, PINZA INTESTINALE	540
DOYEN, PINZA PER POLIPI UTERINI	585
DOYEN, SPECILLO SCANALATO	199
DOYEN, SPECOLO VAGINALE	574
DOYEN, TIRAMIOMI	594
DOYEN-BABY, PINZA INTESTINALE	540
DOYEN-JANSEN (MOLT), APRIBOCCA	454
DOYEN-JANSEN (MOLT), APRIBOCCA	454
DOYEN-STILLE	167
DRAFFIN, ADENOIDECTOMIA - TONSILLECTOMIA	459
DUBOIS FORBICI GINECOLOGICHE	63
DUPLAY, PINZA PER ABBASSARE	582
IL COLLO DELL'UTERO	582
DUPLAY, PINZA PER MEDICATURA	134
DUPLEX STETOSCOPIO	23
DUPUY-WEISS AGO PER TONSILLE	466
DURA DISSETTORE	332
DURA DISSETTORE, DAVIS	332
DURA DISSETTORE, FRAZIER	333
DURA DISSETTORE, HOEN	333
DURA DISSETTORE, HORSLEY	333
DURA DISSETTORE, MILLIGAN	332
DURA DISSETTORE, OLIVECRONA	332
DURA DISSETTORE, SACHS	332
DURA DISSETTORE, TOENNIS	332
DURA DISSETTORE, WOODSON	333
DURANTE PINZA DA PRESA	88

DUVAL, PINZA DA PRESA	85
DUVAL, PINZA PER AFFERRARE INTESTINI	539

E

ECHLIN PINZA SGORBIA	240
ECO, T° COMBINAZIONE PER DIAGNOSTICA CON ILLUMINAZIONE STANDARD	16
ELETTRODO A BISTURI	628
ELETTRODO A SFERA MONOPOLARE	628, 629
ELETTRODO AD ANGO MONOPOLARE	628, 629
ELETTRODO AD ANSA MONOPOLARE	628, 629
ELETTRODO LANCEOLATA MONOPOLARE	628, 629
ELEVATORE AURICOLARE ZAUFAL	409
ELEVATORE AURICOLARE ZAUFAL-JANSEN	409
ELEVATORE CHANDLER	282
ELEVATORE DINGMAN	463/3
ELEVATORE PER GINOCCHIO, BLOUNT	289
ELEVATORE PER OSSA	286/1
ELEVATORE PER OSSA BUCK-GRAMCKO	285
ELEVATORE PER OSSA LANE	290
ELEVATORE PER OSSA LANE TRETOWAN	290
ELEVATORE PER OSSA LANGE-HOHMANN	286
ELEVATORE PER OSSA VERBRUGGE-MÜLLER	286/2
ELEVATORE PER OSSA, BENNETT	283
ELEVATORE PER OSSA, BLOUNT	288
ELEVATORE PER OSSA, BRISTOW	290
ELEVATORE PER OSSA, HOHMANN	284, 285
ELEVATORE PER OSSA, HOHMANN	284, 285
ELEVATORE PER OSSA, HOHMANN MINI	286
ELEVATORE PER OSSA, KOENIG	284
ELEVATORE PER OSSA, SMILLIE	291
ELEVATORE PER PERIOSTIO	463/2
ELEVATORE PER SETTO, FREER	437, 438
ELEVATORE PER SETTO, HOWARTH	438
ELEVATORE PER SETTO, MCKENTY	437
ELEVATORE PER SETTO, SINUS	438
ELEVATORE PER SETTO, BALLENGER	439
ELEVATORE PER SETTO, COTTLE	439
ELEVATORE PER SETTO, COTTLE-JOSEPH	439
ELEVATORE PER SETTO, HAJEK-BALLENGER	439
ELEVATORE PER SETTO, HALLE	437
ELEVATORE PER SETTO, JOSEPH	437
ELEVATORE PER SETTO, KILLIAN	438
ELEVATORE PER SETTO, PENNINGTON	438
ELEVATORE PER SETTO, PIERCE	438
ELEVATORE PER SETTO, ROGER	437
ELEVATORE PER TONSILLE, HENKE	465
ELEVATORE, QUERVAIN	275
ELEVATORE, SEBLEAU	275
ELEVATORE, ALDERDYCE	282
ELEVATORE, BOIES	277
ELEVATORE, CREGO	282
ELEVATORE, FREER	434
ELEVATORE, KEY	282
ELEVATORE, MCDONALD, 19CM	283
ELEVATORE, MURPHY-LANE	283
ELEVATORE, SAYRE	281
ELEVATORE, WATSON-CHEYNE	283
ELEVATORI, GWYNNE EVANS	465
ELEVATORI PER OSSA, HAYES	284
ELEVATORI PER OSSA, LAMBOTTE	287
ELLIOT FORCIPE	602
ELSCHING, DISSETTORE CORNEALE	373
ELSCHING, SPATOLA PER CICLODIALISI	379
ELSCHING, PINZA CAPSULARE	391
ELSCHING, PINZA FISSATRICE	389
EMMETT UNCINO PER FISTOLE	594
ENDOSPECOLO, KOGAN	577
ENGEL SEGA PER GESSI	229
ENUCLEATORE PER TENDINI, BRAND	294
ENUCLEATORE PER TENDINI, BUNELL	292
EPKER, OSTEOTOMI	464/2
EPPENDORFER, PINZA PER BIOPSIA	590

ERRICO PERFORATORE	299
ERRICO TRAPANO	298
ESMARCH BENDA PER COMPRESSIONE	297
ESMARCH COLTELLO PER GESSI	233
ESMARCH FORBICI PER BENDAGGI	69/2
ESTENSIONE DELL'ARTICOLAZIONE	188
ESTRATTATORE, KUENTSCHER	322
ETHICON PINZA APPLICATORE CLIPS	524, 525
EVES SERRANODI PER TONSILLE	468

F

FACE LIFT FORBICI, FREEMAN	74
FACE LIFT FORBICI, GORNEY	73
FACE LIFT FORBICI, KAYE	73
FACE LIFT FORBICI, REES	73
FANSLER PROCTOSCOPIO	565
FARABEUF DIVARICATORE	139
FARABEUF PERIOSTOTOMO	274
FARABEUF TENAGLIA PER OSSA	243
FARABEUF-COLLIN, PERIOSTOTOMO	274
FARABEUF-LAMBOTTE, TENAGLIA PER OSSA	243
FARRELL, PORTACOTONE	203
FAULKNER, CURETTA	449
FAURE PINZA PER BIOPSIA	588
FAURE PINZA PERITONEALE	123
FALVALORO FORBICI VASCOLARI	61
FEHLAND, PINZA INTESTINALE	542
FEILCHENFELD, PINZA PER SCHEGGE	91
FELDHEIM, PINZA PER OSSA	249
FEMALE ORINATOIO	62/12
FERGUSSON, CUCCHIAIO PER CALCOLI BILIARI	533
FERGUSSON, FORBICI PER CHIRURGIA	66
FERGUSSON, FRAZIER CANNULA D'ASPIRAZIONE	337
FERGUSSON, PINZA EMORROIDALE	109
FERGUSSON, TENAGLIA PER OSSA	243
FERRIERA, DIVARICATORE PER CHIRURGIA PLASTICA	197
FERRIS-SMITH, PINZA CHIRURGICA	84
FERRIS-SMITH, PINZA TAGLIANTE PER LAMINECTOMIA	343
FERRIS-SMITH-KERRISON, PINZA TAGLIANTE PER DISCHI INTERVERTEBRALI	344, 344/2
FICHOCHIETTO-BABY, DIVARICATORE COSTALE	482
FILO PER OSSA	314
FINOCCHIETTO, DIVARICATORE COSTALE	482, 484
FINOCCHIETTO, PINZA PER BRONCHI	490
FINOCCHIETTO, DIVARICATORE COSTALE	484
FINOCCHIETTO, PORTAGHI	211
FINOCCHIETTO-BURFORD, DIVARICATORE COSTALE	483
FINSSEN DIVARICATORE	168
FINSTERER, CANNULA PER ASPIRAZIONE	28
FISCH, DISSETTORE	420
FISCH, UNCINO	335
FISCHER, PINZA PER IRIDE	384
FISH, SPECILLO	199
FISHER, COLTELLO PER TONSILLE	466
FOERSTER, PINZA PER IRIDE	383
FOERSTER, PINZA PER MEDICATURA	136
FOMON, FORBICI NASALI	58
FOMON, FORBICI PER RINOPLASTICA	65/1
FOMON, PERIOSTOTOMO	277
FOMON, RASPA NASALE	444
FOMON, SCALPELLO PER SETTO	441
FOMON, TC RASPA NASALE	445
FOMON, UNCINO PER LA PELLE	447/1
FORBICE PER IL SETTO NASALE, KILLIAN	471
FORBICE PER LE UNGHIE	609
FORBICE PER PELLE	610
FORBICI BIPOLARI SOTTILE	634
FORBICI BIPOLARI STANDARD	634
FORBICI BULLDOG, COTTLE	56
FORBICI CORNEALI, CASTROVIEJO	79

FORBICI GINECOLOGICHE, DOYEN	63
FORBICI GINECOLOGICHE, DUBOIS	63
FORBICI GINECOLOGICHE, SIEBOLD	62
FORBICI GINECOLOGICHE, SIMS	62
FORBICI GINGIVALI, GOLDMAN-FOX	67
FORBICI GINGIVALI, LA GRANGE	69
FORBICI GINGIVALI, LOCKLIN	69
FORBICI GINGIVALI, QUINBY	67
FORBICI, GRAEFE	56
FORBICI NASALI	429
FORBICI NASALI, COTTLE	59
FORBICI NASALI, FOMON	58
FORBICI NASALI, HEYMANN	58
FORBICI OCULISTICHE, WESTCOTT	75
FORBICI OCULISTICHE, BARRAQUER	75
FORBICI OCULISTICHE, NOYES	75
FORBICI OCULISTICHE, VANNAS	79
FORBICI OCULISTICHE, WECKER	75
FORBICI PER BENDAGGI	70
FORBICI PER BENDAGGI, BERGMANN	69/1
FORBICI PER BENDAGGI, BRUNS	70
FORBICI PER BENDAGGI, ESMARCH	69/2
FORBICI PER BENDAGGI, KNOWLES	70
FORBICI PER BENDAGGI, LISTER	69/1
FORBICI PER BENDAGGI, LORENZ	70
FORBICI PER BENDAGGI, REDA EXCENTER	69/2
FORBICI PER BENDAGGI, SEUTIN	69/2
FORBICI PER BENDAGGI, SMITH US ARMY	69/1
FORBICI PER BENDAGGI, UNIVERSAL	70
FORBICI PER CAPSULA, RESANO	53/2
FORBICI PER CARTILAGINE, MARTIN	65/1
FORBICI PER CARTILAGINE, MCINDOE	65/1
FORBICI PER CHIRURGIA FINE, IRIS	54
FORBICI PER CHIRURGIA FINE, JOSEPH	54
FORBICI PER CHIRURGIA FINE, KILNER	54
FORBICI PER CHIRURGIA FINE, REYNOLDS	54
FORBICI PER CHIRURGIA FINE, SANVENERO	54
FORBICI PER CHIRURGIA STANDARD	51
FORBICI PER CHIRURGIA, FERGUSSON	66
FORBICI PER CHIRURGIA, METZENBAUM	53/1
FORBICI PER CHIRURGIA, SYSTRUNK	66
FORBICI PER CORDA OMBELICALE, BUSCH	64
FORBICI PER CORDA OMBELICALE, MOD USA	64
FORBICI PER CORDA OMBELICALE, SCHUMACHER	64
FORBICI PER CORONA, BEEBEE	68
FORBICI PER DISSEZIONE	52
FORBICI PER DISSEZIONE, DEEVER	52
FORBICI PER DISSEZIONE, MAYO	52
FORBICI PER DISSEZIONE, MAYO TC	52
FORBICI PER DISSEZIONE, MAYO-STILLE	52
FORBICI PER DISSEZIONE, MAYO-STILLE	52
FORBICI PER DISSEZIONE, MAYO-STILLE, TC	52
FORBICI PER DISSEZIONE, METZENBAUM	53/3, 53/4
FORBICI PER DISSEZIONE, METZENBAUM	53/1
FORBICI PER DISSEZIONE, JORGENSEN	53
FORBICI PER DISSEZIONE, LEXER	53
FORBICI PER DISSEZIONE, LEXER-BABY	53
FORBICI PER DISSEZIONE, LEXER-BABY TC	53
FORBICI PER DISSEZIONE, MAYO-NOBLE	52
FORBICI PER DISSEZIONE, METZENBAUM	53/1
FORBICI PER DISSEZIONE, METZENBAUM FINO	53/1
FORBICI PER DISSEZIONE, METZENBAUM TC	53/1
FORBICI PER DISSEZIONE, TOENNIS-ADSON	65
FORBICI PER DISSEZIONE, WELLER	53/2
FORBICI PER DISSEZIONE, METZENBAUM FINO TC	53/1
FORBICI PER DURAMADRE, SCHMIEDEN-TAYLOR	65/1
FORBICI PER ENTEROTOMIA	66
FORBICI PER EPISIOTOMIA, BRAUN-STADLER	64
FORBICI PER EPISIOTOMIA, WALDMANN	64
FORBICI PER FILO DI METALLO E LAMIERA, UNIVERSAL	67
FORBICI PER INCISIONE	52

FORBICI PER ISTERECTOMIA, WERTHEIM	63
FORBICI PER LEGATURE, HEATH	66
FORBICI PER LEGATURE, LITTAUER	66
FORBICI PER LEGATURE, NORTHBENT	66
FORBICI PER LEGATURE, SPENCER	66
FORBICI PER NEUROCHIRURGIA	65
FORBICI PER NEUROCHIRURGIA, STRULLY	65
FORBICI PER OFTALMOLOGIA	57
FORBICI PER OFTALMOLOGIA, GRADLE	57
FORBICI PER OFTALMOLOGIA, STEVENS	58
FORBICI PER PARAMETRIO	63
FORBICI PER RINOPLASTICA, FOMON	65/1
FORBICI PER STERNO, SCHUMACHER	481
FORBICI PER STRABISMO	481
FORBICI PER STRABISMO	58
FORBICI PER TONSILLE	59
FORBICI PER TONSILLE, BOETTCHER	59
FORBICI PER TONSILLE, DEAN	59
FORBICI PER TONSILLE, GOOD	59
FORBICI PER TONSILLE, PRINCE	59
FORBICI POLMONARE, CRAFOORD	65/2
FORBICI TORACALI, THOREK	65/2
FORBICI VASCOLARI, DEBAKEY TC	60
FORBICI VASCOLARI, DE BAKEY	61
FORBICI VASCOLARI, DIETRICH	60
FORBICI VASCOLARI, FALVALORO	61
FORBICI VASCOLARI, KELLY	61
FORBICI VASCOLARI, KLINCKENBERG-LOTH	65/2
FORBICI VASCOLARI, POTTS-DE MARTEL	59
FORBICI VASCOLARI, POTTS-SMITH	61
FORBICI VASCOLARI, SATINSKY	65/2
FORBICI, WAGNER	67
FORCIPE, DE LEE	602
FORCIPE, ELLIOT	602
FORCIPE, KIELLAND	602
FORCIPE, KIELLAND-LUIKART	603
FORCIPE, LUIKART	603
FORCIPE, MCLEAN	603
FORCIPE, MCLEAN-LUIKART	603
FORCIPE, MCLEAN-TUCKER-LUIKART	603
FORCIPE, NAEGELE	602
FORCIPE, PIPER	604
FORCIPE, SIMPSON	602
FORCIPE, SIMPSON-BRAUN	602
FORCIPE, SIMPSON-LUIKART	603
FORCIPE, WRIGLEY	602
FOX, CURETTA PER LUPUS	608
FRAENKEL, INSERTO	472
FRAENKEL, PINZA PER POLIPI LARINGEI	471
FRANCIS, AGO PER CORPI ESTRANEI	374
FRANKLIN-SILVERMANN, AGO PER BIOPSIA	206
FRAZIER, DIVARICATORE ADDOMINALE	181
FRAZIER DURA, DISSETTORE	333
FRAZIER, UNCINO PER LA PELLE	148/2
FREEMAN, DIVARICATORE PER CHIRURGIA PLASTICA	198
FREEMAN, FACE LIFT FORBICI	74
FREER, COLTELLO PER SETTO NASALE	434
FREER, ELEVATORE	434
FREER, ELEVATORE PER SETTO	437
FREER, SCALPELLO PER SETTO	439
FREER, UNCINO PER LA PELLE	448
FRENZEL, ABBASSALINGUA	451
FRENZEL, OCCHIALI NISTAGMO	20
FRIEDMANN MINI, PINZA SGORBIA	234
FRIEDMANN, SPECOLO VAGINALE	577
FRITSCH, DIVARICATORE	163
FRYKHOLM, PINZA SGORBIA	240
FUCHS, PINZA CAPSULARE	391
FUCHSIG, PINZA EMOSTATICA	113

G

GALLAHER RASPA NASALE	446
-----------------------------	-----

GASS UNCINO	376
GAUSS, PINZA PER IL CUOIO CAPELLUTO	605
GELPI, DIVARICATORE ADDOMINALE	189/1
GELPI, DIVARICATORE ADDOMINALE	189/2
GEMINI, PINZA EMOSTATICA	115
GERALD, PINZA ANATOMICA	86
GERALD, PINZA CHIRURGICA	87
GERSTER, PINZA PER OSSA	250
GERZOG, MARTELLO	270
GHIGLIOTTINA PER TAGLIARE FILI FINO	320
GIERTZ-STILLE, COSTOTOMO	481
GIGLI SEGA	332
GILL, DISSETTORE CORNEALE	373
GILL, PINZA PER IRIDE	384
GILL-ARRUGA, PINZA CAPSULARE	390
GILL-HESS, PINZA PER IRIDE	384
GILLIES, PINZA CHIRURGICA	86
GILLIES, PORT'AGHI	212
GILLIES, UNCINO PER LA PELLE	448
GIL-VERNET DIVARICATORE	152
GIUNTO DI PROLUNGAMENTO	298
GLOVER, BULLDOG PINZA ATRAUMATICA	100
GLOVER, BULLDOG PINZA ATRAUMATICA	103
GLOVER, PINZA VASCOLARE	515
GLUCK COSTOTOMO	480
GOELET, DIVARICATORE	141
GOLDMANN-FOX, FORBICI GINGIVALI	67
GOMEL MICRO FORBICI	80
GOMEL MICROPINZA CHIRURGICA	96
GONIOMETRO PER LE DITA	25
GONIOMETRO, MOELTGEN	25
GOOD FORBICI PER TONSILLE	59
GOODELL DILATATORE UTERINO	581
GORNEY, DISSETTORE	277
GORNEY, FACE LIFT FORBICI	73
GOSSET, DIVARICATORE ADDOMINALE	181
GOURDET, CUCCHIAIO UTERINO	599
GRADLE, FORBICI PER OFTALMOLOGIA	57
GRADLE, PINZA DEPIULATORIA	395
GRAEFE, BLEFAROSTATO	370
GRAEFE, CISTOTOMO	375
GRAEFE, COLTELLO LANCEOLARE	372
GRAEFE, COLTELLO LANCEOLARE	372
GRAEFE, COLTELLO PER CATARATTA	371
GRAEFE, CUCCHIAIO PER CATERATTA	377
GRAEFE, FORBICI	56
GRAEFE, PINZA DA PRESA	83
GRAEFE, PINZA FISSATRICE	389
GRAEFE, PINZA PER IRIDE	382
GRAEFE, UNCINO	377
GRAEFE, UNCINO PER IL STRABISMO	375
GRAFFA PER IL CUOIO CAPELLUTO, RANEY	327
GRAHAM, UNCINO PER NERVI	329
GRAVE, SPECOCO VAGINALE	570
GRAY, PINZA EMOSTATICA	121
GREEN, DISSETTORE CORNEALE	374
GREEN, DIVARICATORE	160
GREEN, PINZA FISSATRICE	390
GREEN, UNCINO PER IL STRABISMO	375
GREEN-ARMYTAG, PINZA UTERINA PER EMOSTASI	605
GREGORY, PINZA CARDIOVASCOLARE ATRAUMATICA	517
GREGORY, PINZE ATRAUMA BULLDOG	100
GREVEN MIKRO-PINZA AURICOLARE	414
GROSS, CUCCHIAIO AURICOLARE	409
GROSS-MAIER, PINZA PER MEDICATURA	134
GRUBER, SPECOCO AURICOLARE	399
GUAINA PER VITI	325
GUIDA CONDUTTRICE	321
GUIDA TENDINI, BUNELL	294
GUILLEN, CANNULA PER ASPIRAZIONE	433/1
GUTHRIE, UNCINO PER LA PELLE	149
GUYON, CANDELETTA DILATATRICE	554

GUYON, INTRODUTTORE PER CATETERI	554
GUYON, PINZA EMOSTATICA	122
GUYON, PINZA RENALE	122
GUYTON-LUNDSSGAARD, SCLEROTOMO	373
GWYNNNE EVANS ELEVATORI	465

H

HABERER SPATOLA ADDOMINALE E INTESTINALE	143/1
HAGLUND-STILLE, DIVARICATORE PER GESSI	232
HAIGHT DIVARICATORE COSTALE	487
HAJEK, MARTELLO	273
HAJEK, SCALPELLO PER SETTO	442/1
HAJEK-BALLENGER, ELEVATORE PER SETTO	439
HAJEK-KOFLER, PINZA SFENOIDALE	430, 431
HALLE, CURETTA TAGLIANTE	253
HALLE, ELEVATORE PER SETTO	437
HALSEY, PORT'AGHI	208
HALSTED-MOSQUITO, PINZA EMOSTATICA	105
HANK, DILATATORE UTERINO	580
HARGIS, ELEVATORE PER PERIOSTIO	463/2
HARGIS, SEPERATORE PER IL CORPO	463/2
HARKEN, PINZA AURICOLA	503
HARMS, SONDA	381
HARRINGTON, DIVARICATORE	147
HARRINGTON, PINZA PER BRONCHI	490
HARRINGTON-PEMBERTON, DIVARICATORE	147
HARTMANN, ABBASSALINGUA	452
HARTMANN, CANNULA PER IRRIGAZIONE	433
HARTMANN, CATETERE AURICOLARE	408
HARTMANN, DIAPASON	403
HARTMANN, PINZA EMOSTATICA	104
HARTMANN, PINZA PER CORPI ESTRANEI	412
HARTMANN, PINZA PER POLIPI	424
HARTMANN, SPECOCO AURICOLARE	399
HARTMANN, SPECOCO NASALE	422
HARTMANN-HALLE, SPECOCO NASALE	421
HARTMANN-HOFFMANN, PINZA PER CORPI ESTRANEI	412
HARTMANN-WULLSTEIN, PINZA PER CORPI ESTRANEI	412
HAUGH MIKRO-PINZA AURICOLARE	414
HAYES, ELEVATORI PER OSSA	284
HAYES, PINZA PER ANASTOMOSI DEL RETTO	545
HEANEY, PINZA PER ISTERECTOMIA	126
HEANEY, PORT'AGHI	210
HEANY, CURETTA PER BIOPSIA	587
HEANY, DIVARICATORE	164
HEANY-BALLENTINE, PINZA PER ISTERECTOMIA	127
HEATH, FORBICI PER LEGATURE	66
HEATH, MARTELLO	273
HEBRA, CURETTA DA CALAZIO	377
HEGAR, DILATATORE UTERINO	578, 579
HEIFETZ SPATOLA CEREBRALE	369
HEIMING, PINZA PER CALCOLI RENALI	536
HEISS, PINZA EMOSTATICA	112
HEISTER APRIBOCCA	454
HENKE, ELEVATORE PER TONSILLE	465
HENLEY, DIVARICATORE	170
HENNIG, DIVARICATORE PER GESSI	232
HEPP-SCHIEDL, MICRO FORBICI	78
HERRICK, PINZA PER PEDUNCOLO RENALE	123
HESS, PINZA CAPSULARE	391
HESS, PINZA PER IRIDE	384
HESS, UNCINO PER NERVI	329/1
HEYMANN, FORBICI NASALI	58
HEYMANN, PINZA PER SETTO NASALE	425
HEYMANN-KNIGHT, PINZA AURICOLARE	425
HEYWOOD-SMITH, PINZA PER EMORROIDI	567
HIBBS, DIVARICATORE	164
HIBBS, OSTEOTOMO	265
HIBBS, SCALPELLO	265
HIBBS, SGORBIA	265

HILL-FERGUSON, SPECOCO RETTALE	560
HIRSCHMAN, SPATOLA PER CICLODIALISI	379
HIRSCHMANN, ANOSCOPO	562
HOEN DURA, DISSETTORE	333
HOESEL, PORT'AGHI	213
HOFER, DIVARICATORE	465
HOHMANN MINI, ELEVATORE PER OSSA	286
HOLSER, UNCINO PER RADICI DEI NERVI	329/1
HOLZBACH, PINZA PER ISTERECTOMIA	126
HOLZBACH, PINZA PER ISTERECTOMIA	126
HOLZHEIMER, DIVARICATORE	168
HOPKINS COLTELLO PER GESSI	233
HORGAN, DIVARICATORE ADDOMINALE	183
HORIZON, PINZA APPLICATORE CLIPS	524, 525
HORSLEY DURA, DISSETTORE	333
HÖSEL, DIVARICATORE	167
HOUSE, CANNULA D'ASPIRAZIONE	337/2
HOUSE, CURETTA	420
HOWARTH, ELEVATORE PER SETTO	438
HRYNYSCHAK, DIVARICATORI VESICALI	553
HUBER, MANICO UNIVERSALE	472
HUDSON, MANICO A T	298
HUDSON, PERFORATORE A MANO	298
HULKA, PINZA PER ABBASSARE IL COLLO DELL'UTERO	583
HUMBY DERMATOMO	50
HUNTER, PINZA PER SCHEGGE	91
HURD, DISSETTORE PER TONSILLE	465

I

I.U.D. PINZA DA PRESA FLESSIBILE, SERPENTINE	593
I.U.D. UNCINO ESTRATTORE	593
IMPATTATORE	322
IMPATTATORE / ESTRATTORE	322
IMPATTATORE FINALE, KUENTSCHER	321
INGE DIVARICATORE PER CORPI VERTREBRALI	339
INSERTO, BARACANI	472
INSERTO, BRUENINGS	472
INSERTO, CORDES	472
INSERTO, FRAENKEL	472
INSERTO, FRAENKEL	472
INSERTO, KRAUSE	472
INSERTO, LANGE	472
INSERTO, SCHEINMANN	472
INSERTO, SCHUMACHER	472
INSERTO, SEIFERT	472
INSTRU CARE, OLIO PER STRUMENTI	635
INTRODOTTORE PER CATETERI, GUYON	554
IOWA, AGO DI GUIDA	206
IOWA, PINZA PER ABBASSARE IL COLLO DELL'UTERO	584
IRIS, FORBICI	54
IRIS FORBICI, KNAPP	55
IRIS FORBICI, LITTLER	55
IRIS SUPER CUT FORBICI	72
ISRAEL, DIVARICATORE	162
ISTEROMETRO, VALLEIX	586
ISTEROMETRO, COLLIN	586
ISTEROMETRO, MARTIN	586
ISTEROMETRO, SIMS	586
ITERSON DIVARICATORE TRACHEALE	477
IVES-FANSLER ANOSCOPO	562, 563
IWANSON COMPASSO	227

J

JACKSON, BURROWS DIVARICATORE ADDOMINALE	189/2
JACKSON, DIVARICATORE TRACHEALE	476
JACKSON, PINZA PER AFFERRARE TENDINI DA PRESA	292
JACKSON, PINZA PER POLIPI LARINGEI	471

JACKSON, SPECOCO VAGINALE.....	573
JACOBS, PINZA PER ABBASSARE IL COLLO DELL'UTERO.....	583
JACOBSON, CURETTA TAGLIANTE.....	257
JACOBSON, PINZA EMOSTATICA.....	105
JACOBSON, PORT'AGHI.....	215
JACOBSON, SONDA BOTTUNUTA.....	335
JACOBSON, UNCINO PER DURA MADRE.....	335
JAEGER, COLTELLO LANCEOLARE.....	372
JAEGER, PLACCA PER PALPEBRE.....	371
JAMESON, PINZA PER STRABISMO.....	385
JAMESON, UNCINO PER IL STRABISMO.....	375
JANSEN, CURETTA TAGLIANTE.....	257
JANSEN, DIVARICATORE.....	168
JANSEN, PINZA AURICOLARE.....	424
JANSEN, PINZA SGORBIA.....	237
JARCHO, PINZA PER ABBASSARE IL COLLO DELL'UTERO.....	583
JAVID, PINZA PER CAROTIDE.....	511
JENNINGS, APRIBOCCA.....	454
JENSEN, CANNULA OCULISTICA.....	394
JOHNSON-HORNE, PORTACOTONE.....	203
JOHNS-HOPKINS, BULLDOG PINZA.....	104
JOHNS-HOPKINS, PINZA APPLICATRICE.....	104
JOHNS-HOPKINS, PINZA EMOSTATICA.....	120
JONES, PINZA FISSATELI.....	132
JORGENSEN, FORBICI PER DISSEZIONE.....	53
JOSEPH (LEWIS), RASPA NASALE.....	443
JOSEPH, COLTELLO NASALE.....	434
JOSEPH, ELEVATORE PER SETTO.....	437
JOSEPH, FORBICI PER CHIRURGIA.....	54
JOSEPH, PERIOTOTOMO.....	277
JOSEPH, RASPA NASALE.....	443
JOSEPH SEGA NASALE.....	446
JOSEPH, UNCINO PER LA PELLE.....	149
JUDD-ALLIS, PINZA PER AFFERRARE INTESTINI.....	538
JUDD-MASSON, DIVARICATORE VESCICALE.....	552
JUERS MIKRO-PINZA AURICOLARE.....	414
JURASZ, PINZA PER POLIPI LARINGEI.....	471
KADER, SPATOLA ADDOMINALE ED INTESTINALE.....	143/1

K

KALLMORGEN, SPECOCO VAGINALE.....	573
KALT, PINZA CAPSULARE.....	391
KALT, PORT'AGHI.....	214
KALT-ARRUGA, PORT'AGHI.....	214
KANE, PINZA OMBELICALE.....	605
KANTROWITZ, PINZA EMOSTATICA.....	119/1
KAYE, FACE LIFT FORBICI.....	73
KEINSASSER, LARINGOSCOPIO PER OPERAZIONE.....	35
KEITH AGO.....	223
KELLY, DIVARICATORE.....	164
KELLY, FORBICI VASCOLARI.....	61
KELLY, GRIP DIVARICATORE.....	142
KELLY, PINZA EMOSTATICA.....	106
KELLY, PINZA PER POLIPI UTERINI.....	585
KELLY, PROCTOSCOPIO.....	562, 563
KELLY-RANKIN, PINZA EMOSTATICA.....	106
KERN, TENAGLIA PER OSSA.....	244
KERRISON, PINZA TAGLIANTE NASALE.....	428
KEVORKIAN, CURETTA PER BIOPSIA.....	587
KEVORKIAN, PINZA PER BIOPSIA.....	589
KEVORKIAN-PACIFIC, PINZA PER BIOPSIA.....	592
KEY, ELEVATORE.....	282
KEYES, TREFINA CUTANEA.....	608
KIELLAND, FORCIPE.....	602
KIELLAND-LUIKART, FORCIPE.....	603
KILLIAN, CANNULA PER IRRIGAZIONE.....	433, 433/1
KILLIAN, FORBICE PER IL SETTO NASALE.....	471
KILLIAN, PER IRRIGAZIONE.....	433, 433/1
KILLIAN, SGORBIA.....	442/1

KILLIAN, SPECOCO NASALE.....	423
KILLIAN-CLAUS, SGORBIA PER SETTO.....	442/1
KILNER, FORBICI PER CHIRURGIA.....	54
KILNER, PORT'AGHI.....	212
KILNER, SUPERCUT FORBICI.....	72
KILNER, UNCINO NASALE.....	447/1
KILNER, UNCINO PER LA PELLE.....	608
KILNER-DOUGHTY, APRIBOCCA.....	456
KIRBY-ARTHUR, PINZA PER IRIDE.....	385
KIRK MARTELLO.....	270
KIRSCHNER, ARCO PER ESTENSIONE.....	312
KIRSCHNER, DIVARICATORE ADDOMINALE.....	185
KIRSCHNER, DIVARICATORE ADDOMINALE.....	187
KIRSCHNER, PERFORATORI FILIFORMI.....	306, 307
KIRSCHNER, SPECILLO DI GUIDA SCANALATO.....	221
KIRSCHNER, US ARCO PER ESTENSIONE.....	312
KIRSCHNER, TELAIIO PIEGABILE.....	187
KIT PER AUTOPSIA IN ASTUCCIO DI LEGNO.....	269
KLAPP, DIVARICATORE.....	150
KLEINERT-KUTZ, PINZA PER AFFERRARE TENDINI.....	294
KLEINERT-KUTZ, PINZA SGORBIA.....	237
KLEINERT-KUTZ, UNCINO PER LA PELLE.....	149
KLEINSASSER, BRACCIO PORTALARINGOSCOPIO STERNALE.....	36
KLEINSASSER, CANNULA DA INIEZIONE.....	36
KLEINSASSER, CANNULA D'ASPIRAZIONE.....	36
KLEINSASSER, PORTATORE DI LUCE.....	36
FREDDA A FIBRE DI VETRO.....	36
KLINKENBERGH-LOTH.....	652
KNAPP, CUCCHIAIO PER CATERATTA.....	378
KNAPP IRIS, FORBICI.....	55
KNAPP, UNCINO DIVARICATORE.....	375
KNAPP-LUER, PINZA PER TRACOMA.....	393
KNIGHT, PINZA PER SETTO NASALE.....	425
KNOWLES, FORBICI PER BENDAGGI.....	70
KOCHER, DIVARICATORE.....	155
KOCHER, DIVARICATORE.....	159
KOCHER, DIVARICATORE.....	160
KOCHER, DIVARICATORE.....	163
KOCHER, PINZA EMOSTATICA.....	108
KOCHER, PINZA INTESTINALE.....	540
KOCHER, SONDA PER GOZZO.....	479
KOCHER, SPATOLA VESCICALE.....	552
KOCHER-LANGENBECK, DIVARICATORE.....	159
KOENIG, AGO.....	223
KOERTE, DIVARICATORE.....	162
KOGAN, ENDOSPECOLO.....	577
KONIG, DIVARICATORE.....	153
KÖNIG, ELEVATORE PER OSSA.....	284
KÖNIG, PERIOTOTOMO.....	276
KÖNIG, SPECILLO DI GUIDA SCANALATO.....	221
KOOS COLTELLO PER DURA MADRE.....	335
KÖRTE SPATOLA ADDOMINALE ED INTESTINALE.....	143/1
KRAUSE, INSERTO.....	472
KRAUSE, SERRANODI.....	411
KRAUSE, SERRANODI.....	433/2
KRAUSE-VOSS, SERRANODI.....	433/2
KRAYENBÜHL, UNCINO PER NERVI.....	336
KRISTELLER, SPECOCO VAGINALE.....	572
KROENIG, ABBASSALINGUA.....	451
KROENIG, AGO PER LEGATURE.....	219
KUGLEN, UNCINO.....	376
KUHNT, RASCHIAIOIO CORNEALE.....	373
KÜMMEL, SPATOLA ADDOMINALE.....	144
KÜMMEL, SPATOLA ADDOMINALE E INTESTINALE.....	143/2
KÜNTSCHER ALESATORE PER FEMORE.....	321
KÜNTSCHER ALESATORE PER L'APERTURA DEL MIDOLLO.....	321
KÜNTSCHER ESTRATTATORE.....	322
KÜNTSCHER IMPATTATORE FINALE.....	321

L

LA FORCE AGO PER CORPI ESTRANEI.....	374
LA FORCE COLTELLO ADENOIDE.....	450
LA GRANGE FORBICI GINGIVALI.....	69
LABORDE DILATATORE TRACHEALE.....	476
LACRIMAL CANNULA OCULISTICA.....	394
LAHEY, DIVARICATORE.....	157
LAHEY, PINZA EMOSTATICA.....	119/2
LAHEY, PINZA PER GOZZO.....	479
LAHEY, UNCINI PER NERVI E DIVARICATORI FINI.....	149
LAHEY, UNCINO ACUTO.....	149
LAMA, DI RASOIO.....	45
LAMA, DI RICAMBIO.....	49
LAMA, DI RICAMBIO, STERILE.....	50
LAMA, PER OSTEOTOMI.....	266
LAMA, PER SCALPELLI.....	266
LAMBERT, PINZA PER CALAZIO.....	393
LAMBERT-KAY, PINZA PER ANASTOMOSI.....	505
LAMBERT-LOWMAN, PINZA PER OSSA.....	249
LAMBOTTE, ELEVATORI PER OSSA.....	287
LAMBOTTE, OSTEOTOMO.....	261
LAMBOTTE, TENAGLIA PER OSSA.....	244
LAME PER BISTURI, STERILI.....	42
LAMPADA FRONTALE, CLAR.....	22
LAMPADINA DI RISERVA.....	31-32
LANCASTER, BLEFAROSTATO.....	371
LANDAU, SPECOCO VAGINALE.....	577
LANE, CACCIAVITE.....	323, 324
LANE, ELEVATORE PER OSSA.....	290
LANE, PIEGAPLACCHE.....	325
LANE, PINZA CHIRURGICA.....	84
LANE, PINZA FISSATELI.....	133
LANE, PINZA PORTAPLACCHE.....	325
LANE, PINZA PORTAVITI.....	325
LANE, PINZA STOMACALE.....	548
LANE, TENAGLIA PER OSSA.....	244
LANE, TRETOWAN ELEVATORE PER OSSA.....	290
LANG, DISSETTORE PER SACCO LACRIMALE.....	378
LANGE, INSERTO.....	472
LANGE, UNCINO PER LE PINNIE NASALI.....	448
LANGE-HOHMANN, ELEVATORE PER OSSA.....	286
LANGENBECK, ANSA AURICOLARE.....	409
LANGENBECK, COLTELLO PER AMPUTAZIONE.....	44
LANGENBECK, COLTELLO PER CARTILAGINI.....	47
LANGENBECK, DIVARICATORE.....	158
LANGENBECK, DIVARICATORE.....	159
LANGENBECK, PERIOTOTOMO.....	275
LANGENBECK, PORT'AGHI.....	213
LANGENBECK, SEGA PER DITA.....	296
LANGENBECK, TENAGLIA PER OSSA.....	243
LANGENBECK-GREEN, DIVARICATORE.....	153
LANGENBECK-MANNERFELT, DIVARICATORE CON IMPUGNATURA A TREATINGOLO.....	148/4
LARINGOSCOPIO, MCINTOSH.....	29
LARINGOSCOPIO, MILLER.....	30
LARINGOSCOPIO PER OPERAZIONE KLEINSASSER.....	35
LARSEN, PINZA PER AFFERRARE TENDINI.....	292
LAWRENCE, PINZA EMOSTATICA.....	119
LEBSCHKE SCALPELLO PER STERNO.....	267
LEES PINZA PER BRONCHI.....	504
LEGATORE EMORROIDALE, MC GIVNEY.....	568
LEGATORE EMORROIDALE, RUDD.....	568
LEGUEU, SPATOLA VESCICALE.....	552
LEKSELL(STILLE), PINZA SGORBIA.....	240
LELAND-JONES, PINZA VASCOLARE.....	494
LEMPERT, CURETTA TAGLIANTE.....	256
LEMPERT, PINZA SGORBIA.....	237
LERCHE, PINZA DA PRESA.....	83
LERICHE, PINZA EMOSTATICA.....	111
LERICHE, SPATOLA ADDOMINALE E INTESTINALE.....	143/2
LESINA.....	304

LESINA, PERTHES..... 304
 LESINE, OMBREDANNE..... 304
 LESTER, PINZA FISSATRICE..... 389
 LEVA, PER CORPI ESTRANEI, BUCK..... 412
 LEVA, PER CORPI ESTRANEI, QUIRE..... 412
 LEVA, PIEGLAPLACCHE, LANE..... 325
 LEWIN, TENAGLIA PER OSSA..... 246
 LEWY, SUPPORTO TORACICO..... 37
 LEXER BABY, FORBICI PER DISSEZIONE..... 53
 LEXER, FORBICI PER DISSEZIONE..... 53
 LEXER MINI, SGORBIA..... 263
 LEXER, OSTEOTOMO..... 263
 LEYLA, SISTEMA.....
 DI FISSAGGIO..... 368, 368/1, 368/2, 368/3, 368/4
 LICHTWITZ, CANNULA..... 433
 LICHTWITZ TREQUARTO PER SENO MASCELLARE..... 204
 LIEBERMANN, BLEFAROSTATO..... 371
 LIMA PER OSSA..... 294
 LIMA PER OSSA..... 612/1
 LISTER, FORBICI PER BENDAGGI..... 69/1
 LISTER, SUPERCUT FORBICI..... 72
 LISTER(SINUS), TUPFERZA..... 137
 LISTON, CESCOIA PER OSSA..... 241
 LISTON, COLTELLO PER AMPUTAZIONE..... 44
 LITTAUER, FORBICI PER LEGATURE..... 66
 LITTAUER, PINZA AURICOLARE..... 411
 LITTAUER, PINZA DEPIPARATORIA..... 395
 LITTAUER, PINZA PER POLIPI..... 425
 LITTLE DIVARICATORE..... 157
 LITTLE IRIS FORBICI..... 55
 LITTLEWOOD, PINZA PER AFFERRARE INTESTINI..... 538
 LOCKHART-MUMMERY, SPECILLO PER FISTOLE..... 200
 LOCKLIN, FORBICE GINGIVALI..... 69
 LOCKWOOD-ALLIS, PINZA PER AFFERRARE INTESTINI..... 538
 LONDON-COLLEGE, PINZA DENTALE..... 93
 LOPEZ-REINKE, DISSETTORE PER TONSILLE..... 465
 LORENZ, FORBICI PER BENDAGGI..... 70
 LORNA, PINZA FISSATELI..... 133
 LOUTE STRUMENTO TENDIFILI..... 315
 LOVE, DIVARICATORE..... 465
 LOVE, UNCINO PER NERVI..... 329/2
 LOVE, UNCINO PER RADICI DEI NERVI..... 330
 LOVE-GRUENWALD, PINZA TAGLIENTE PER LAMINECTOMIA..... 340
 LOVELACE, PINZA EMOSTATICA..... 109
 LOVELACE, PINZA PER AFFERRARE IL POLMONE..... 490
 LOWER, PINZA EMOSTATICA..... 120
 LOWMAN, PINZA PER OSSA..... 249
 LOWMAN-HOGLUND, PINZA PER OSSA..... 249
 LUBET-BARBON, PINZA NASALE PER TAMPONI..... 424
 LUC, PINZA PER SETTO NASALE..... 426
 LUCAE, AGO PER PARACETESI..... 408
 LUCAE, DIAPASON..... 404
 LUCAE, MARTELLO..... 271
 LUCAE, PINZA AURICOLARE..... 410
 LUCAE, UNCINO..... 409
 LUER, CANNULA TRACHEALE..... 479
 LUER, DIVARICATORE..... 140
 LUER, PINZA SGORBIA..... 236
 LUER-KOERTE, CUCCHIAIO PER CALCOLI BILIARI..... 533
 LUIKART, FORCIPE..... 603
 LUIKART-BILL, TRATTORE..... 604
 LUNDSSGAARD, SCLEROTOMO..... 373
 LUNIATSCHEK, TAMPONATORE..... 465

M

MAGALURAN,
 ADENOIDECTOMIA - TONSILLECTOMIA..... 459
 MAGILL, PINZA PER INTRODUZIONE SONDE..... 28
 MALTZ (COTTLE), RASPA NASALE..... 444
 MALTZ, RASPA NASALE..... 443
 MAMMARIA, DIVARICATORE..... 487/1

MANDIBOLARE..... 463/6
 MANICI PER LAMA BISTURI..... 38-41
 MANICI PER LAMA BISTURI..... 38
 MANICI PER LAMA BISTURI..... 39
 MANICI PER LAMA BISTURI..... 39/1
 MANICI PER LAMA BISTURI..... 39/2
 MANICI PER LAMA BISTURI..... 40
 MANICI PER LAMA BISTURI..... 41
 MANICI PER LAMA BISTURI, BARRON..... 38
 MANICO..... 266
 MANICO..... 300
 MANICO A BATTERIA PER LUCE CALDA..... 32
 MANICO A BATTERIA PER LUCE CALDA..... 34
 MANICO A BATTERIA PER LUCE FREDDA..... 33
 MANICO A T, HUDSON..... 298
 MANICO CON ATTACCO RAPIDO..... 301
 MANICO D'ASPIRAZIONE, WULLSTEIN..... 338
 MANICO PER STRUMENTI MICROLARINGEI..... 475
 MANICO UNIVERSALE, HUBER..... 472
 MANIGLIE DI LARYNGOSKOPE..... 31-32, 34
 MANIGLIE PER LARINGOSCOPIO..... 31-32, 34
 MANNERFELT, DIVARICATORE CON IMPUGNATURA A TREANGOLO..... 148/3, 148/4, 148/5
 MANO DI PIOMBO..... 250
 MARQUARDT, PINZA SGORBIA..... 239
 MARSCHIK, PINZA PER TONSILLE..... 468
 MARTEL, PINZA DA PRESA..... 110
 MARTELLI, DOYEN..... 271
 MARTELLO DI PERCUSSIONE, BABINSKY..... 24
 MARTELLO DI PERCUSSIONE, BERLINER..... 24
 MARTELLO DI PERCUSSIONE, BUCK..... 24
 MARTELLO DI PERCUSSIONE, TAYLOR..... 24
 MARTELLO DI PERCUSSIONE, TROEMNER..... 24
 MARTELLO, IN PLASTICA..... 271
 MARTELLO, BERGMANN..... 272
 MARTELLO, COLLIN..... 270
 MARTELLO, COTTLE..... 273
 MARTELLO, GERZOG..... 270
 MARTELLO, HAJEK..... 273
 MARTELLO, HEATH..... 273
 MARTELLO, KIRK..... 270
 MARTELLO, LUCAE..... 271
 MARTELLO, MEAD..... 271
 MARTELLO, OMBREDANNE..... 273
 MARTELLO, PARTSCH..... 271
 MARTELLO, QUISLING..... 271
 MARTELLO, WILLIGER..... 271
 MARTIN, DIVARICATORE..... 175/1
 MARTIN, FORBICI PER CARTILAGINE..... 65/1
 MARTIN, ISTEROMETRO..... 586
 MARTIN, PELVIMETRO..... 605
 MARTIN, TENAGLIA PER OSSA..... 246
 MARTINI, CURETTA TAGLIENTE..... 257
 MASCHIO ORINATOIO..... 621/2
 MASING-NEIVERT, UNCINO NASALE..... 447/1
 MASSON, PORT'AGHI..... 210
 MASTIN, PINZA MUSCOLARE..... 479
 MATHIEU, DIVARICATORE..... 141
 MATHIEU, PINZA PER CORPI ESTRANEI..... 553/1
 MATHIEU, PORT'AGHI..... 213
 MATHIEU, SPECILO RETTALE..... 560
 MATHIEU-OLSEN, PORT'AGHI..... 212
 MATSON, PERIOSTOTOMO..... 279
 MATSON-ALEXANDER, PERIOSTOTOMO..... 279
 MAUNDER APRIBOCCA DI LEGNO..... 459
 MAXI GRASPER PINZA PER BIOPSIA..... 593
 MAYFIELD, PINZA SGORBIA..... 238
 MAYO, ABBASSALINGUA..... 451
 MAYO CUCCHIAIO PER CALCOLI BILIARI..... 534
 MAYO FORBICI PER DISSEZIONE..... 52
 MAYO, PINZA..... 89
 MAYO, SONDA PER CALCOLI BILIARI..... 534
 MAYO, SPILLONE PER STERILIZZAZIONE..... 227
 MAYO, SUPERCUT FORBICI..... 71

MAYO-ADAMS, DIVARICATORE..... 171
 MAYO-BLAKE, PINZA PER CALCOLI BILIARI..... 531
 MAYO-COLLINS, DIVARICATORE..... 141
 MAYO-COLLINS, DIVARICATORE-SET..... 141
 MAYO-HABERISSER, PINZA TORCIFILI..... 319
 MAYO-HEGAR, PORT'AGHI..... 209
 MAYON-GUYON, PINZA EMOSTATICA..... 122
 MAYO-NOBLE, FORBICI PER DISSEZIONE..... 52
 MAYO-ROBSON, PINZA INTESTINALE..... 541
 MAYO-STILLE, FORBICI PER DISSEZIONE..... 52
 MAYO-STILLE, SUPERCUT FORBICI..... 71
 MCDONALD, ELEVATORE..... 283
 MCINDOE, CESCOIA PER OSSA..... 241
 MCINTOSH, LARINGOSCOPIO..... 29
 MCINTOSH, LARINGOSCOPIO SET..... 31
 MCKENZIE, PERFORATORE..... 299
 MCKENZIE, TRAPANO..... 298
 MCCULLOUGH, PINZA PER STRABISMO..... 385
 MCGEE MIKRO-PINZA AURICOLARE..... 414
 MCGEE, UNCINO..... 419
 MCGIVNEY, LEGATORE EMORROIDALE..... 568
 MCGIVNEY, PINZA EMORROIDALE..... 568
 MCINDOE, FORBICI PER CARTILAGINE..... 65/1
 MCINDOE, PINZA CHIRURGICA..... 85
 MCINTOSH, LARYNGOSKOPE..... 29/1-30/1
 MCINTOSH, LARYNGOSKOPE IMPOSTA..... 29-30
 MCINTYRE, CANNULA OCULISTICA..... 394
 MCIVOR, APRIBOCCA..... 457
 MCKENTY, ELEVATORE PER SETTO..... 437
 MCKENZIE, PINZA POSA CLIPS..... 326
 MCKESSON, TELAIO METALLICO..... 454/1
 MCLEAN, FORCIPE..... 603
 MCLEAN-LUIKART, FORCIPE..... 603
 MCLEAN-TUCKER-LUIKART, FORCIPE..... 603
 MCPHERSON, PINZA PER FILO..... 392
 MEAD, MARTELLO..... 271
 MEAD, PINZA SGORBIA..... 235
 MEEKER, PINZA EMOSTATICA..... 119
 MEHDORN, CLIPS PER VASI..... 362
 MEHDORN, PINZA POSA CLIPS..... 362
 MELLINGER, BLEFAROSTATO..... 370
 MENGHINI, AGO PER BIOPSIA..... 206
 MERIAM, PINZA DENTALE..... 93
 METZENBAUM FINO, TC FORBICI PER DISSEZIONE..... 53/1
 METZENBAUM, FORBICI PER CHIRURGIA..... 54
 METZENBAUM FORBICI PER DISSEZIONE..... 53/3, 53/4
 METZENBAUM, FORBICI PER DISSEZIONE..... 53/1
 METZENBAUM, PORT'AGHI..... 211
 METZENBAUM, SUPERCUT FORBICI..... 71
 METZENBAUM, TC FORBICI PER DISSEZIONE..... 53/1
 MEYERDING, DIVARICATORE..... 157
 MEYERDING, DIVARICATORE..... 177
 MEYERDING, DIVARICATORE..... 180
 MEYHOEFFER, CURETTA DA CALAZIO..... 377
 MICHEL, AGRAFES..... 224
 MICHEL, PINZA PER AGRAFES..... 224
 MICHEL, SPECCHIO LARINGEO..... 423
 MICRO FORBICI..... 76
 MICRO FORBICI..... 77
 MICRO FORBICI..... 78
 MICRO FORBICI AURICOLARI, BELLUCCI..... 413
 MICRO FORBICI AURICOLARI, SHEA..... 413
 MICRO FORBICI, GOMEL..... 78
 MICRO FORBICI, HEPP-SCHIEDL..... 80
 MICRO FORBICINE, BELLUCCI..... 417
 MICRO FRIEDMANN PINZA SGORBIA..... 234
 MICRO PINZA AURICOLARE..... 415
 MICRO PINZA AURICOLARE A CUCCHIAIO, WULLSTEIN..... 416
 MICRO-HARTMANN, PINZA EMOSTATICA..... 104
 MICROPINZA CHIRURGICA, GOMEL..... 96
 MICROVASCULAR PORT'AGHI..... 210
 MIDDENDORPF DIVARICATORE..... 160

MIDDLETON-JANSEN, PINZA PER SETTO NASALE	430
MIKRO COLTELLO FALCATO	475
MIKRO SEPERATORE	475
MIKRO UNCINO	475
MIKRO-PINZA AURICOLARE	413
MIKRO-PINZA AURICOLARE, COS	414
MIKRO-PINZA AURICOLARE, DIETER	414
MIKRO-PINZA AURICOLARE, GREVEN	414
MIKRO-PINZA AURICOLARE, HAUGH	414
MIKRO-PINZA AURICOLARE, JUERS	414
MIKRO-PINZA AURICOLARE, MCGEE	414
MIKULICZ, DIVARICATORE	163
MIKULICZ, PINZA INTESTINALE	543
MIKULICZ, PINZA PERITONEALE	123
MIKULICZ-BABY, PINZA PERITONEALE	123
MILLER, LARINGOSCOPIO	30
MILLER, LARYNGOSKOPE	29/3, 30/3
MILLER, LARYNGOSKOPE IMPOSTA	29/2-30/2
MILLER, RASPA NASALE	444
MILLIGAN DURA, DISSETTORE	332
MILLIN, DIVARICATORE VESCICALE	552
MILLIN, DIVARICATORE VESCICALE	553
MILLIN, PINZA CAPSULARE DA PRESA	551
MILLIN, PINZA DA PRESA PER LA PROSTATA	551
MINI MANICO, CON ATTACCO RAPIDO	301
MINI-LAMBOTTE, OSTEOTOMO	262
MINIMUS III, SFGIMOMANOMETRO	12
MIXTER, PINZA CURVA AD „S“	116
MIXTER, PINZA PER CALCOLI BILIARI	531
MIXTER-BABY, PINZA EMOSTATICA	119/1
MIXTER-O-SHAUGNESSY, PINZA EMOSTATICA	119/2
MOD BONN, PINZA PER IRIDE	387
MOD MÜNCHEN, CURETTA PER BIOPSIA	587
MOD TÜBINGEN, PINZA PER IRIDE	387
MOD VIENNA, SPECOLO NASALE	421
MODELLATORE PER CHIODI, BENDER	322
MODELLO RUSSO, PINZA DA PRESA	85
MODELLO STRASSBURG, PINZA CHIRURGICA	89
MOELTGEN GONIOMETRO	25
MOGEN STRUMENTO PER CIRCONCISIONE	556
MOLLISON, DIVARICATORE	171
MOLT, PERIOSTOTOMO	276
MONOPOLAR ELEKTRODEN ANSAN	628, 629
MOORFIELD, PINZA PER SUTURA	392
MORGAN, PROTOSCOPI	565
MORITZ-SCHMIDT, ABBASSALINGUA	452
MORRIS, DIVARICATORE	164
MORRIS-DEBAKEY, PINZA AORTA	506
MORSE, DIVARICATORE COSTALE	484
MORSE-FAVALORO, DIVARICATORE COSTALE	484
MOYNIHAN, PINZA EMOSTATICA	120
MOYNIHAN, SONDA PER CALCOLI BILIARI	532
MUELLER, BLEFAROSTATO	371
MÜLLER, CLIPS PER VASI	364,365
MURDOCK, BLEFAROSTATO	370
MURPHY-LANE, ELEVATORE	283
MUSEUX, PINZA PER ABBASSARE IL COLLO DELL'UTERO	583
MYLES, PINZA NASALE	427

N

NABATOFF SET PER VARICI IN SCATOLA DI METALLO	201
NAEGELE, FORCIPE	602
NAGER, AGO PER TONSILLE	466
NAGER, DIVARICATORE	465
NEFF COLTELLO PER MENISCO	292
NEGUS, PINZA PER TONSILLE	467
NEGUS, SUPPORTO PER PETTO	459
NEIVERT, PORT'AGHI	208
NEIVERT-ANDERSON, OSTEOTOMO NASALE	442
NELATON, SPECILLO SCANALATO	199
NELSON, STANDARD TREQUARTO	204

NELSON, TREQUARTO	205
NEONATAL, PINZA VASCOLARE CASTANEDA	527
NEWS, DIVARICATORE TRACHEALE	477
NISSEN, PINZA EMOSTATICA	113
NORFOLK-NORWICH, DIVARICATORE	172
NORTHBENT, FORBICI PER LEGATURE	66
NOTO, PINZA PER POLIPI UTERINI	585
NOVAK, CURETTA PER BIOPSIA	587
NOYES, FORBICI OCULISTICHE	75
NOYES, PINZA PER POLIPI	425

O

OBWEGESER, AGO DI INTRODUZIONE	463
OBWEGESER, AGO DI INTRODUZIONE	463/3
OBWEGESER, DIVARICATORE	460, 461
OBWEGESER, OSTEOTOMO A LAMA	464/1
OBWEGESER, PERIOSTOTOMO	461, 462, 463
OCCHIALI NISTAGMO, FRENZEL	20
OCHSNER, SONDE PER CALCOLI BILIARI	531
OCHSNER, TREQUARTO	205
O'CONNOR, UNCINO PER IRIDE	375
OEHLER, PINZA CHIRURGICA	81/1
OLDBERG, PINZA TAGLIANTE PER LAMINECTOMIA	341
OLIO PER STRUMENTI INSTRU CARE	635
OLIVECRONA DURA, DISSETTORE	332
OLIVECRONA, PINZA SGORBIA	237
OLIVECRONA SEGA IN FILO D'ACCIAIO	332
OLIVECRONA SPATOLA CEREBRALE	336
OLIVECRONA-TOENNIS (SCOVILLE)	326
OLIVECRONA-TOENNIS, PINZA POSA CLIPS	326
OLLIER, DIVARICATORE	162
OLSEN-HEGAR, PORT'AGHI	212
OMBREDANNE (JACKSON), PINZE FISSATELI	133
OMBREDANNE, LESINE	304
OMBREDANNE, MARTELLO	273
ORINATOIO FEMALE	621/2
ORINATOIO MASCHIO	621/2
OSTEOTOME, COTTLE	440
OSTEOTOMI	259
OSTEOTOMI	464
OSTEOTOMI, EPKER	464/2
OSTEOTOMO A LAMA, OBWEGESER	464/1
OSTEOTOMO, LEXER	263
OSTEOTOMO, MINI-LAMBOTTE	262
OSTEOTOMO NASALE, NEIVERT-ANDERSON	442
OSTEOTOMO PER SETTO, COTTLE	440
OSTEOTOMO PER SETTO, FOMON	441
OSTEOTOMO PER SETTO, SHEEHAN	441
OSTEOTOMO, HIBBS	265
OSTEOTOMO, LAMBOTTE	261
OSTEOTOMO, SMITH-PETERSEN	261
OSTEOTOMO, STILLE	260
OSTETOTOMO PER, SETTO RUBIN	440
OSTROEM PINZA TAGLIANTE PER SETTO NASALE	430
OSTROEM PINZA TAGLIANTE PER SETTO NASALE	430
O'SULLIVAN-O'CONNOR, DIVARICATORE ADDOMINALE	181
O'SULLIVAN-O'CONNOR, SPECOLO VAGINALE	576
OTIS, CANDELETTE DILATATRICI	544
OTIS URETROTOMO	553
OVERHOLT, PINZA EMOSTATICA	114
OVERHOLT-BABY, PINZA EMOSTATICA	114
OVERHOLT-GEISENDOERFER, PINZA EMOSTATICA	114
OVERHOLT-MIXTER, PINZA EMOSTATICA	115

P

PADELLA	621
PARK, BLEFAROSTATO	371
PARKER, DIVARICATORE	139

PARTSCH, MARTELLO	271
PARTSCH, SCALPELLO	259
PARTSCH, SGORBIA	259
PASSOW, PESTELLO DA TAMPONARE	260
PATON, DISSETTORE CORNEALE	373
PAUFIQUE, COLTELLO PER CHERATOPLASTICA	373
PAUFIQUE, PINZA PER FILO	392
PAYR, SCHIACCIATORE PER L'INTESTINO E LO STOMACO	549
PAYR, SPECILLO DI GUIDA SCANALATO	221
PEAN, PINZA DA PRESA	110
PEAN, PINZA EMOSTATICA	108
PECK-JOSEPH, FACE LIFT FORBICI	74
PECK-JOSEPH, FACE LIFT FORBICI	74
PEDERSON, SPECOLO VAGINALE	570
PEENFIELD, DISSETTORE	333
PEERS, PINZA FISSATELI	132
PEET, PINZA PER SCHEGGE	92
PEET, RASPA NASALE	446
PELKMANN, PINZA PER MEDICATURA	137
PELVIMETRO, COLLIER	605
PELVIMETRO, COLLIN	605
PELVIMETRO, MARTIN	605
PENNINGTON ELEVATORE PER SETTO	438
PENNINGTON PINZA EMOSTATICA	109
PERCY RETRATTORE	296
PERFORATORE A MANO, BUNELL	299
PERFORATORE A MANO, HUDSON KPLT	298
PERFORATORE A MANO, RALK	298
PERFORATORE ELICOIDALE	302
PERFORATORE INTRAIDMOLLARE	322
PERFORATORE, CRUTCHFIELD	327
PERFORATORE, CUSHING	299
PERFORATORE, ERRICO	299
PERFORATORE, MC KENZIE	299
PERFORATORE, SMELLIE	607
PERFORATORI FILIFORME, KIRSCHNER	306, 307
PERIOSTOTOMO	279
PERIOSTOTOMO, MELT	276
PERIOSTOTOMO, SELDIN	277
PERIOSTOTOMO, ADSON	282
PERIOSTOTOMO, ALEXANDER	276
PERIOSTOTOMO, COBB	280
PERIOSTOTOMO, DINGMANN	463
PERIOSTOTOMO, DOYEN	278
PERIOSTOTOMO, FARABEUF	274
PERIOSTOTOMO, FARABEUF-COLLIN	274
PERIOSTOTOMO, FOMON	277
PERIOSTOTOMO, JOSEPH	277
PERIOSTOTOMO, KOENIG	276
PERIOSTOTOMO, LAMBOTTE	274
PERIOSTOTOMO, LANGENBECK	275
PERIOSTOTOMO, MATSON	279
PERIOSTOTOMO, MATSON-ALEXANDER	279
PERIOSTOTOMO, OBWEGESER	461, 462, 463
PERIOSTOTOMO, SEMB	276
PERIOSTOTOMO, WILLIGER	278
PERKINS DIVARICATORE	168
PERTHES LESINA	304
PESTALOZZA CURETTA PER ABORTO	606
PESTELLO DA TAMPONARE, PASSOW	260
PHANEUF PINZA PERITONEALE	123
PIERCE ELEVATORE PER SETTO	438
PIERCE TREQUARTO PER SENO MASCELLARE	204
PIFFARD CURETTA PER LUPUS	608
PILLING PINZA APPLICATORE CLIPS SMAL	524, 525
PINARD STETOSCOPIO	23
PINZA AD ASTA TUBOLARE PER MICROCHIRURGIA	474
PINZA ANATOMICA, ADSON	82
PINZA ANATOMICA, ADSON MICRO	82
PINZA ANATOMICA, BONNEY	88
PINZA ANATOMICA, BONNEY	88
PINZA ANATOMICA, BROPHY	84

PINZA ANATOMICA, CUSHING.....	83	PINZA DA PRESA, DUVAL	85	PINZA EMOSTATICA, ZENKER.....	118
PINZA ANATOMICA, GERALD.....	86	PINZA DA PRESA, GRAEFÉ	83	PINZA EMOSTATICA, OVERHOLT-BABY.....	114
PINZA ANATOMICA, MCINDOE.....	85	PINZA DA PRESA, LERCHE	83	PINZA EMOSTATICA, OVERHOLT-GEISSENDORFER	114
PINZA ANATOMICA, MOD USA.....	81	PINZA DA PRESA, MARTEL	110	PINZA EMOSTATICA, OVERHOLT-MIXTER.....	115
PINZA ANATOMICA, POTTS-SMITH	81	PINZA DA PRESA, MODELLO RUSSO	85	PINZA FISSATELI	133
PINZA ANATOMICA, SEMKEN	86	PINZA DA PRESA, PEAN	110	PINZA FISSATELI BALL AND SOCKET	133
PINZA ANATOMICA, STANDARD	81	PINZA DA PRESA, PRATT.....	110	PINZA FISSATELI, BACKHAUS	132
PINZA ANATOMICA, STILLE	81	PINZA DA PRESA, WILLET MARTEL	110	PINZA FISSATELI, BERNHARD	133
PINZA ANATOMICA, TAYLOR.....	87	PINZA DENTALE, LONDON-COLLEGE	93	PINZA FISSATELI, DOYEN	133
PINZA ANATOMICA, TC.....	81	PINZA DENTALE, MERIAM	93	PINZA FISSATELI, JONES	132
PINZA ANEURISMA DEBAKEY-BAHNSON	506	PINZA DEPILATORIA BEER	395	PINZA FISSATELI, LANE	133
PINZA AORTA DIETRICH	510	PINZA DEPILATORIA, BARRAQUER	395	PINZA FISSATELI, LORNA	133
PINZA AORTA MORRIS-DEBAKEY	506	PINZA DEPILATORIA, DOUGLAS	395	PINZA FISSATELI, PEERS.....	132
PINZA ATRAUMATICA BULLDOG, DE BAKÉY	100	PINZA DEPILATORIA, GRADLE	395	PINZA FISSATELI, ROEDER	132
PINZA ATRAUMATICA BULLDOG, GLOVER.....	100	PINZA DEPILATORIA, LITTAUER	395	PINZA FISSATELI, SCHAEDEL	132
PINZA ATRAUMATICA IN TITANIO, DEBAKEY	99	PINZA DEPILATORIA, REDA	395	PINZA FISSATELI, TOHOKU	132
PINZA ATRAUMATICA PER NEONATI E BAMBINI	523	PINZA EMORROIDALE FERGUSSON	109	PINZA FISSATRICE, BARRAQUER	390
PINZA ATRAUMATICA TC DEBAKEY	99	PINZA EMORROIDALE, MCGIVNEY	568	PINZA FISSATRICE, CASTROVIEJO	390
PINZA AURICOLARE, HARTMANN	411	PINZA EMOSTATICA, BIRKETT	116	PINZA FISSATRICE, ELSCHNIG	389
PINZA AURICOLARE, HEYMANN-KNIGHT.....	425	PINZA EMOSTATICA, BRIDGE	116	PINZA FISSATRICE, GRAEFÉ	389
PINZA AURICOLARE, JANSEN	424	PINZA EMOSTATICA, COLLER-CRILE	106	PINZA FISSATRICE, GREEN.....	390
PINZA AURICOLARE, LITTAUER.....	411	PINZA EMOSTATICA, DEBAKEY-MOSQUITO	509	PINZA FISSATRICE, LESTER.....	389
PINZA AURICOLARE, LUCAE	410	PINZA EMOSTATICA, DEBAKEY-PEAN	513	PINZA INTESTINALE, BRUNNER	543
PINZA AURICOLARE, TILLEY	411	PINZA EMOSTATICA, DEBAKEY-RANKIN	512	PINZA INTESTINALE PER BIOPSIA, YEOMAN	566
PINZA AURICOLARE, TROELTSCH.....	424	PINZA EMOSTATICA, FUCHSIG	113	PINZA INTESTINALE, SCUDDER	541
PINZA AURICOLARE, WILDE (TROELTSCH).....	410	PINZA EMOSTATICA, KANTROWITZ.....	119/1	PINZA INTESTINALE, BABY-KOCHER	540
PINZA AURICOLA, HARKEN.....	503	PINZA EMOSTATICA, KOCHER	108	PINZA INTESTINALE, DOYEN	540
PINZA BIPOLARE	630, 631	PINZA EMOSTATICA, NISSEN	113	PINZA INTESTINALE, FEHLAND	542
PINZA BIPOLARE A BAIONETTA.....	631, 632	PINZA EMOSTATICA, OVERHOLT	114	PINZA INTESTINALE, KOCHER	540
PINZA CAPSULARE DA PRESA, MILLIN	551	PINZA EMOSTATICA, PEAN	108	PINZA INTESTINALE, MAYO-ROBSON	541
PINZA CAPSULARE, ARRUGA.....	391	PINZA EMOSTATICA, PEAN	108	PINZA INTESTINALE, WIKSTROEM	543
PINZA CAPSULARE, CASTROVIEJO	391	PINZA EMOSTATICA, ADSON	112	PINZA INTESTINALE, RESANO	542
PINZA CAPSULARE, ELSCHNIG	391	PINZA EMOSTATICA, ADSON-BABY	113	PINZA INTESTINALE, STONE-WATT	545
PINZA CAPSULARE, FUCHS.....	391	PINZA EMOSTATICA, BAINBRIDGE	119/2	PINZA, MAYO	89
PINZA CAPSULARE, GILL-ARRUGA.....	390	PINZA EMOSTATICA, BENGOLEA.....	112	PINZA MODELLO STRASSBURG	89
PINZA CAPSULARE, HESS	391	PINZA EMOSTATICA, CRAFOORD	118	PINZA MUSCOLARE, BERKE	389
PINZA CAPSULARE, KALT	391	PINZA EMOSTATICA, CRAFOORD-SELLORS	119	PINZA MUSCOLARE, MASTIN	479
PINZA CAPSULARE, SCHWEIGGER.....	391	PINZA EMOSTATICA, CRILE	107	PINZA MUSCOLARE, PRINCE	387
PINZA CAPSULARE, TERSON	391	PINZA EMOSTATICA, CRILE-RANKIN	107	PINZA NASALE, CRAIG	426
PINZA CARDIOVASCOLARE ATRAUMATICA.....	526	PINZA EMOSTATICA, DANDY	109	PINZA NASALE PER TAMPONI, LUBET-BARBON	424
PINZA CARDIOVASCOLARE	518, 519, 522	PINZA EMOSTATICA, DESJARDINS.....	121	PINZA NASALE PER TAMPONI, WESTMACOTT	424
PINZA CARDIOVASCOLARE	515	PINZA EMOSTATICA, GEMINI	115	PINZA NASALE, WEIL-BLAKESLEY	426
PINZA CARDIOVASCOLARE	517	PINZA EMOSTATICA, GRAY	121	PINZA NASALE, CAPLAN	428
PINZA CHIRURGICA, GERALD.....	87	PINZA EMOSTATICA, GUYON	122	PINZA NASALE, HARTMANN	427
PINZA CHIRURGICA, POTTS SMITH	81	PINZA EMOSTATICA, HALSTED-MOSQUITO	105	PINZA NASALE, MYLES	427
PINZA CHIRURGICA STANDARD	81/1	PINZA EMOSTATICA, HARTMANN	104	PINZA NASALE, SCHMEDEN	427
PINZA CHIRURGICA, WAUGH	83	PINZA EMOSTATICA, HEISS.....	112	PINZA NASALE, STRUYCKEN	427
PINZA CHIRURGICA, ADSON	82	PINZA EMOSTATICA, JACOBSON	105	PINZA NASALE, TAKAHASHI.....	427
PINZA CHIRURGICA, ADSON MICRO	82	PINZA EMOSTATICA, JOHNS-HOPKINS	120	PINZA NASALE, WATSON-WILLIAMS	428
PINZA CHIRURGICA, ADSON-BROWN	82	PINZA EMOSTATICA, KELLY	106	PINZA OMBELICALE, COLLIN.....	605
PINZA CHIRURGICA, BONNEY.....	88	PINZA EMOSTATICA, KELLY-RANKIN	106	PINZA OMBELICALE, KANE	605
PINZA CHIRURGICA, BROPHY.....	84	PINZA EMOSTATICA, LAHEY	119/2	PINZA PER ABBASSARE IL COLLO DELL	
PINZA CHIRURGICA, CUSHING	83	PINZA EMOSTATICA, LAWRENCE	119	'UTERO, CZERNY	584
PINZA CHIRURGICA, FERRIS-SMITH	84	PINZA EMOSTATICA, LERICHE	111	PINZA PER ABBASSARE IL COLLO DELL	
PINZA CHIRURGICA, GILLIES	86	PINZA EMOSTATICA, LOVELACE	109	'UTERO, SCHRÖDER	583, 584
PINZA CHIRURGICA, LANE	84	PINZA EMOSTATICA, LOWER	120	PINZA PER ABBASSARE IL COLLO DELL	
PINZA CHIRURGICA, MCINDOE	85	PINZA EMOSTATICA, LOWER	120	'UTERO, BARRET	582
PINZA CHIRURGICA, MOD	81/1	PINZA EMOSTATICA, MAYO-GUYON	122	PINZA PER ABBASSARE IL COLLO DELL	
PINZA CHIRURGICA, OEHLER TC	81/1	PINZA EMOSTATICA, MEEKER	119	'UTERO, BRAUN	582
PINZA CHIRURGICA, SEMKEN.....	86	PINZA EMOSTATICA, MEEKER	119	PINZA PER ABBASSARE IL COLLO DELL	
PINZA CHIRURGICA, STILLE	81/1	PINZA EMOSTATICA, MICRO-HARTMANN.....	104	'UTERO, DUPLAY	582
PINZA CHIRURGICA, TAYLOR.....	87	PINZA EMOSTATICA, MIXTER.....	119/1	PINZA PER ABBASSARE IL COLLO DELL	
PINZA COPERCHIO, REDA	615	PINZA EMOSTATICA, MIXTER-BABY	119/1	'UTERO, MOYNIHAN	120
PINZA CURVA AD „S“ MIXTER.....	116	PINZA EMOSTATICA, MOYNIHAN	120	PINZA EMOSTATICA, O'SHAUGNESSY	119/2
PINZA DA PRESA	316, 317	PINZA EMOSTATICA, O'SHAUGNESSY	119/2	PINZA EMOSTATICA, PENNINGTON	109
PINZA DA PRESA COTTLE	410	PINZA EMOSTATICA, PENNINGTON	109	PINZA EMOSTATICA, PROVIDENCE-HOSPITAL	106
PINZA DA PRESA PER FILI, KIRSCHNER	305	PINZA EMOSTATICA, ROBERTS	117	PINZA EMOSTATICA, ROBERTS	117
PINZA DA PRESA PER LA PROSTATÀ, MILLIN	551	PINZA EMOSTATICA, ROCHESTER-CARMALT	109	PINZA EMOSTATICA, ROCHESTER-CARMALT	109
PINZA DA PRESA PER TONSILLE, ABRAHAM	468	PINZA EMOSTATICA, ROCHESTER-OCHSNER	108	PINZA EMOSTATICA, ROCHESTER-OCHSNER	108
PINZA DA PRESA, COLLIN-DUVAL	85	PINZA EMOSTATICA, ROCHESTER-PEAN	108	PINZA EMOSTATICA, ROCHESTER-PEAN	108
PINZA DA PRESA, DURANTE	88	PINZA EMOSTATICA, RUMEL	117	PINZA EMOSTATICA, RUMEL	117
		PINZA EMOSTATICA, SAROT	118	PINZA EMOSTATICA, SAROT	118
		PINZA EMOSTATICA, SPENCER-WELLS.....	109	PINZA EMOSTATICA, SPENCER-WELLS.....	109
		PINZA EMOSTATICA, STILLE	122	PINZA EMOSTATICA, STILLE	122
		PINZA EMOSTATICA, TOENNIS	117	PINZA EMOSTATICA, TOENNIS	117

'UTERO, SCHROEDER.....	583, 584	PINZA PER BIOPSIA, VAN DOREN	588	PINZA PER MEDICATURA, ULRICH.....	135
PINZA PER ABBASSARE IL COLLO DELL 'UTERO, SCHROEDER (POZZI).....	582	PINZA PER BIOPSIA, WITTMER	589	PINZA PER MICROCHIRURGIA	94
PINZA PER ABBASSARE IL COLLO DELL 'UTERO, SKENE.....	582	PINZA PER BIOPSIA, TISCHLER-MORGAN	590	PINZA PER OCCLUSIONE TANGENZIALE, DEBAKEY-SATINSKY	502
PINZA PER ABBASSARE IL COLLO DELL 'UTERO, STAUDE-MOORE.....	582	PINZA PER BRONCHI, FINOCCHIETTO	490	PINZA PER OSSA LAMBERT-LOWMAN	249
PINZA PER ABBASSARE IL COLLO DELL 'UTERO, TEALE.....	583	PINZA PER BRONCHI, HARRINGTON	490	PINZA PER OSSA, FELDHEIM.....	249
PINZA PER ABORTO, SAENGER.....	606	PINZA PER BRONCHI, LEES.....	504	PINZA PER OSSA, GERSTER.....	250
PINZA PER ABORTO, WINTER.....	606	PINZA PER BRONCHI, PRICE-THOMAS	490	PINZA PER OSSA, LOWMAN.....	249
PINZA PER AFFERRARE IL POLMONE, LOVELACE.....	490	PINZA PER BRONCHI, SEMB.....	491	PINZA PER OSSA, LOWMAN-HOGLUND.....	249
PINZA PER AFFERRARE INTESTINI DOYEN-BABY	540	PINZA PER BRONCHI, ESOFAGOSCOPIA, CHEVALIER-JACK.....	473	PINZA PER PATELLA	248
PINZA PER AFFERRARE INTESTINI LOCKWOOD-ALLIS.....	538	PINZA PER CALAZIO, AYER.....	393	PINZA PER PEDUNCOLO RENALE, HERRICK	123
PINZA PER AFFERRARE INTESTINI, ALLIS	537	PINZA PER CALAZIO, DESMARES.....	393	PINZA PER PEDUNCOLO RENALE, WERTHEIM-CULLEN.....	125
PINZA PER AFFERRARE INTESTINI, ALLIS-ADAIR	537	PINZA PER CALAZIO, LAMBERT	393	PINZA PER PILORO, BENSON	544
PINZA PER AFFERRARE INTESTINI, ALLIS-BABY	537	PINZA PER CALCOLI BILIARI, BLAKE	531	PINZA PER POLIPI LARINGEI, FRAENKEL	471
PINZA PER AFFERRARE INTESTINI, ATRAUMA	111	PINZA PER CALCOLI BILIARI, DESJARDINS	531	PINZA PER POLIPI LARINGEI, JURASZ	471
PINZA PER AFFERRARE INTESTINI, BABCOCK	539	PINZA PER CALCOLI BILIARI, MAYO-BLAKE	531	PINZA PER POLIPI LARINGEI, JACKSON.....	471
PINZA PER AFFERRARE INTESTINI, COLLIN	539	PINZA PER CALCOLI BILIARI, MIXTER	531	PINZA PER POLIPI UTERINI, DOYEN	585
PINZA PER AFFERRARE INTESTINI, DUVAL	539	PINZA PER CALCOLI RENALI, HEIMING	536	PINZA PER POLIPI UTERINI, KELLY	585
PINZA PER AFFERRARE INTESTINI, JUDD-ALLIS	538	PINZA PER CALCOLI RENALI, RANDALL	535	PINZA PER POLIPI UTERINI, NOTO.....	585
PINZA PER AFFERRARE INTESTINI, LITTLEWOOD	538	PINZA PER CAROTIDE, JAVID	511	PINZA PER POLIPI, HARTMANN	424
PINZA PER AFFERRARE INTESTINI, THOMS-ALLIS	538	PINZA PER CATETERI, COOLEY	510	PINZA PER POLIPI, LITTAUER	425
PINZA PER AFFERRARE INTESTINI, WILLIAMS	539	PINZA PER COARTAZIONE E ANASTOMOSI POTTS.....	492, 493	PINZA PER POLIPI, NOYES	425
PINZA PER AFFERRARE L'UTERO, COLLIN	585	PINZA PER CORPI ESTRANEI, STRUEMPEL	412	PINZA PER RADDRIZZARE IL SETTO NASALE, ASCH	449
PINZA PER AFFERRARE L'UTERO, DARTIGUES	585	PINZA PER CORPI ESTRANEI, HARTMANN	412	PINZA PER RADDRIZZARE IL SETTO NASALE, WALSHAM	449
PINZA PER AFFERRARE L'UTERO, SOMER	585	PINZA PER CORPI ESTRANEI, HARTMANN-HOFFMANN.....	412	PINZA PER RIFIUTI, SAUERBRUCH	227
PINZA PER AFFERRARE TENDINI	293	PINZA PER CORPI ESTRANEI, HARTMANN-WULLSTEIN.....	412	PINZA PER RIPOSIZIONE, ROWE	459
PINZA PER AFFERRARE TENDINI JACKSON	292	PINZA PER CORPI ESTRANEI, MATHIEU	563/1	PINZA PER ROVESCIARE PALPEBRE, SNELLEN	393
PINZA PER AFFERRARE TENDINI KLEINERT-KUTZ	294	PINZA PER CRANIOTOMIA CONE	331	PINZA PER SCHEGGE	91
PINZA PER AFFERRARE TENDINI, BRAND	293	PINZA PER EMORROIDI, HEYWOOD-SMITH	567	PINZA PER SCHEGGE, ARCHER	92
PINZA PER AFFERRARE TENDINI, CAROLL	293	PINZA PER FILO, MCPHERSON	392	PINZA PER SCHEGGE, CARMALT	91
PINZA PER AFFERRARE TENDINI, LARSEN	292	PINZA PER FILO, MOTTUEBINGEN	392	PINZA PER SCHEGGE, FELCHNFELD	91
PINZA PER AFFERRARE TENDINI, STEINMANN	292	PINZA PER FILO, PAUFIQUE.....	392	PINZA PER SCHEGGE, HUNTER	91
PINZA PER AFFERRARE TESSUTI, BROWN	83	PINZA PER GOZZO, LAHEY.....	479	PINZA PER SCHEGGE, PEET	92
PINZA PER AFFERRARE TESSUTI, CHAPUT	110	PINZA PER IL CUOIO CAPELLUTO, GAUSS	605	PINZA PER SCHEGGE, VIRTUS (RALK)	92
PINZA PER AFFERRARE TESSUTI, COLLIN	110	PINZA PER INTRODUZIONE SONDE, MAGILL	28	PINZA PER SCHEGGE, STIEGLITZ	92
PINZA PER AFFERRARE TESSUTI, SINGLEY	88	PINZA PER IPOFISI.....	34	PINZA PER SETTO NASALE, BRUENINGS	425
PINZA PER AFFERRARE TESSUTI, TUFFIER	110	PINZA PER IPOFISI, ADSON	331	PINZA PER SETTO NASALE, HEYMANN.....	425
PINZA PER AGRAFES, CHILDE.....	224	PINZA PER IRIDE, BARRAQUER (COLIBRI)	384	PINZA PER SETTO NASALE, LUC	426
PINZA PER AGRAFES, COLLIN.....	224	PINZA PER IRIDE, BARRAQUER-KATZIN	384	PINZA PER SETTO NASALE, MIDDLETON-JANSEN.....	430
PINZA PER AGRAFES, WACHENFELDT	224	PINZA PER IRIDE, BISHOP-HARMAN	386	PINZA PER SETTO NASALE, RUBIN	428
PINZA PER AGRAFES, RICHTER-HEATH	224	PINZA PER IRIDE, BONN	387	PINZA PER SINUSCOPIA	431
PINZA PER ANASTOMOSI DEL RETTO, HAYES	545	PINZA PER IRIDE, FISCHER.....	384	PINZA PER STERILIZZAZIONE	227
PINZA PER ANASTOMOSI, BECK	516	PINZA PER IRIDE, FOERSTER	383	PINZA PER STERILIZZAZIONE, DAVIS	227
PINZA PER ANASTOMOSI, BECK	520	PINZA PER IRIDE, GILL	384	PINZA PER STERILIZZAZIONE, CHEATLE	227
PINZA PER ANASTOMOSI, COOLEY-DERRA	519	PINZA PER IRIDE, GILL-HESS	384	PINZA PER STERILIZZAZIONE, ROGGE	227
PINZA PER ANASTOMOSI, DE MARTEL-WOLFSON	546-547	PINZA PER IRIDE, GRAEFE	382	PINZA PER STERILIZZAZIONE, UNIVERSAL	227
PINZA PER ANASTOMOSI, DEBAKEY	505	PINZA PER IRIDE, HESS	384	PINZA PER STRABISMO, BONACCOLTO	385
PINZA PER ANASTOMOSI, LAMBERT-KAY	505	PINZA PER IRIDE, KIRBY-ARTHUR	385	PINZA PER STRABISMO, DASTOOR	386
PINZA PER AORTA, WEBER.....	501	PINZA PER IRIDE, MOD BONN.....	387	PINZA PER STRABISMO, JAMESON	385
PINZA PER APPENDICE, ALLEN.....	544	PINZA PER IRIDE, MOD TUEBINGEN	387	PINZA PER STRABISMO, MCCULLOUGH	385
PINZA PER BIOPSIA BABY BURKE	590	PINZA PER IRIDE, TROUTMAN	389	PINZA PER SUTURA, CASTROVIEJO	392
PINZA PER BIOPSIA BABY TISCHLER	592	PINZA PER IRIDE, STEVENS	383	PINZA PER SUTURA, MOORFIELD	392
PINZA PER BIOPSIA SCHUMACHER	588, 589	PINZA PER ISTERECTOMIA, SEGOND	125	PINZA PER SUTURA, ST MARTIN	392
PINZA PER BIOPSIA TOWNSEND	591	PINZA PER ISTERECTOMIA, SEGOND-LANDAU	125	PINZA PER TAMPONI, BOZEMANN	138
PINZA PER BIOPSIA, ALEXANDER	589	PINZA PER ISTERECTOMIA, HEANEY	126	PINZA PER TAMPONI, BOZEMANN-DOUGLAS	138
PINZA PER BIOPSIA, BURKE	590	PINZA PER ISTERECTOMIA, HEANY-BALLENTINE	127	PINZA PER TONSILLE, COLVER	467
PINZA PER BIOPSIA, EPPENDORFER	590	PINZA PER ISTERECTOMIA, ROGERS	127	PINZA PER TONSILLE, BALLENGER	467
PINZA PER BIOPSIA, FAURE	588	PINZA PER ISTERECTOMIA, WERTHEIM	124	PINZA PER STERILIZZAZIONE, FAURE	467
PINZA PER BIOPSIA, KEVORK.....	592	PINZA PER ISTERECTOMIA, WERTHEIM	128	PINZA PER TONSILLE, MARSCHIK	468
PINZA PER BIOPSIA, KEVORKIAN	589	PINZA PER LACERAZIONE UNGHIE, RADOLF	297	PINZA PER TONSILLE, NEGUS	467
PINZA PER BIOPSIA, KEVORKIAN	591	PINZA PER MEDICATURA	135	PINZA PER TONSILLE, SAWTELL	467
PINZA PER BIOPSIA, MAXI GRASPER	593	PINZA PER MEDICATURA, BRYANT	137	PINZA PER TONSILLE, SCHNIDT	467
PINZA PER BIOPSIA, SCHUBERT	588	PINZA PER MEDICATURA, CHERON	137	PINZA PER TONSILLE, TYDING	467, 468
PINZA PER BIOPSIA, THOMAS-GAYLOR	588	PINZA PER MEDICATURA, COLLIN	137	PINZA PER TONSILLE, WHITE	467
PINZA PER BIOPSIA, TISCHLER	591	PINZA PER MEDICATURA, DUDLEY	134	PINZA PER TRACOMA, KNAPP-LUER	393
PINZA PER BIOPSIA, TISCHLER-KEVORK	592	PINZA PER MEDICATURA, FOERSTER	136	PINZA PER TRAZIONE CRANIALE, CRUTCHFIELD	327
PINZA PER BIOPSIA, TISCHLER-MORGAN	590, 591	PINZA PER MEDICATURA, GROSS-MAIER	134	PINZA PER TUMORI, YASARGIL	97
		PINZA PER MEDICATURA, LISTER (SINUS)	137	PINZA PERITONEALE, FAURE	123
		PINZA PER MEDICATURA, PELKMANN.....	137	PINZA PERITONEALE, MIKULICZ, 20CM	123
		PINZA PER MEDICATURA, RAMPLEY	136		
		PINZA PER MEDICATURA, SIMS-MAIER.....	134		

PINZA PERITONEALE, MIKULICZ-BABY	123	PINZA VASCOLARE, BAINBRIDGE	495/1-495/2	PORTAGHI, LANGENBECK	213
PINZA PERITONEALE, PHANEUF	123	PINZA VASCOLARE, GLOVER	515	PORTAGHI, MASSON	210
PINZA PORTAPLACCHE, LANE	325	PINZA VASCOLARE, ADLERKREUTZ	84	PORTAGHI, MATHIEU	213
PINZA PORTAVITI, LANE	325	PINZA VASCOLARE, DIEFFENBACH	104	PORTAGHI, MATHIEU-OLSEN	212
PINZA POSA CLIPS, BIEMER	361,363,364,366	PINZA VASCOLARE, LELAND-JONES	494	PORTAGHI, MAYO-HEGAR	209
PINZA POSA CLIPS, MEHDORN	362	PINZA VASCOLARE, SATINSKY	491	PORTAGHI, METZENBAUM	211
PINZA POSA CLIPS, RANEY	327	PINZA VASCOLARE, WANGENSTEEN	89	PORTAGHI, NEIVERT	208
PINZA RENALE, GUYON	122	PINZA VASCOLARE, STILLE-BARRAYA	88	PORTAGHI, OLSEN-HEGAR	210
PINZA SERRAPENE, STOCKMANN	553/1	PINZA, DAVIS	227	PORTAGHI, RYDER	212
PINZA SERRAPENE, STRAUSS	553/1	PINZE ATRAUMA BULLDOG, GREGORY	100	PORTAGHI, SAROT	211
PINZA SERRATUBI	129	PINZE ATRAUMATICHE BULLDOG, DE BAKY	103	PORTAGHI, STEVENS	214
PINZA SERRATUBI, BÜLOW-GUNAR-HEY	130	PINZE ATRAUMATICHE BULLDOG, GLOVER	103	PORTAGHI, STRATTE	212
PINZA SFENOIDALE, HAJEK-KOFLER	430,431	PINZE ATRAUMATICHE BULLDOG IN TITANIO	102	PORTAGHI, WANGENSTEEN	210
PINZA SGORBIA, BANE-HARTMANN	237	PINZE ATRAUMATICHE, DE BAKY	98	PORTAGHI, WEBSTER	208
PINZA SGORBIA, MAYFIELD	238	PINZE EMOSTATICHE CHRISTOPHE	107	PORTALEGATURE, VIENNA	221/1
PINZA SGORBIA, SMITH-PETERSEN	238	PINZE EMOSTATICHE TERRIER	106	PORTATORE DI LUCE FREDDA A	
PINZA SGORBIA, ADSON	236	PINZE FISSATELI OMBREDANNE (JACKSON)	133	FIBRE DI VETRO, KLEINSASSER	36
PINZA SGORBIA, BLUMENTHAL	236	PINZE PER DISSEZIONE E LEGATURE,		POSA CLIPS	357,358, 359, 360
PINZA SGORBIA, BOEHLER	238	DE BAKY SATINSKY	504/1	POSA CLIPS JOHNS-HOPKINS	104
PINZA SGORBIA, CLEVELAND	235	PINZE PER DISSEZIONE, CHIRURGICHE/ANATOMICHE,		POSA CLIPS, MC KENZIE	326
PINZA SGORBIA, ECHLIN	240	DENIS- BROWNE	89	POSA CLIPS, SMITHWICK	326
PINZA SGORBIA, FRIEDMAN-MICRO	234	PINZE PER LEGATURE, DE BAKY-MIXTER	499/2	POST MORTEM AGO	268
PINZA SGORBIA, FRIEDMAN-MINI	234	PINZE PER PREPARAZIONE E PER LEGATURA	128/2	POTTS, PINZA PER COARTAZIONE E	
PINZA SGORBIA, FRYKHOLM	240	PINZE PER SCHEGGE	90	ANASTOMOSI	492, 493
PINZA SGORBIA, JANSEN	237	PINZE, RESANO	85	POTTS SMITH, PINZA CHIRURGICA	81
PINZA SGORBIA, KLEINERT-KUTZ	237	PINZER FORCIPE	604	POTTS-DE MARTEL, FORBICI VASCOLARI	59
PINZA SGORBIA, LEMPERT	237	PISTOLA LAVATRICE	626	POTTS-SMITH, FORBICI VASCOLARI	61
PINZA SGORBIA, LUER	236	PISTONI	258, 259	POTTS-SMITH, PINZA ANATOMICA	81
PINZA SGORBIA, MARQUARDT	239	PISTONI, CASPAR	258	PRATT, DILATATORE UTERINO	580
PINZA SGORBIA, MEAD	235	PLACCA PER PALPEBRE, JAEGER	371	PRATT, PINZA DA PRESA	110
PINZA SGORBIA, OLIVECRONA	237	PLACCA PER STENDIPELLE	49	PRATT, PINZA PER ABBASSARE IL	
PINZA SGORBIA, RUSKIN	239	PLESTER, CANNULA D'ASPIRAZIONE	338	COLLO DELL'UTERO	584
PINZA SGORBIA, SAUERBRUCH	240	PLESTER, COLTELLO	418	PRATT, SPECILLO PER FISTOLE	563
PINZA SGORBIA, SCAGLIETTI	240	PLESTER, DIVARICATORE	171	PRATT, SPECILO RETTALE	559
PINZA SGORBIA, SEMB	240	POLITZER, AGO PER PARACENTESI	408	PRICE-THOMAS, PINZA PER BRONCHI	490
PINZA SGORBIA, STELLBRINK	234	POLITZER, COLTELLO AURICOLARE	408	PRINCE, FORBICI PER TONSILLE	59
PINZA SGORBIA, ZAUFAL-JANSEN	238	POLITZER, SPECILO AURICOLARE	399	PRINCE, PINZA MUSCOLARE	387
PINZA SGORBIA, LEKSELL-STILLE	240	POMPA D'ARIA	295	PROCTOSCOPO, BENSANDE	565
PINZA SGORBIA, STILLE-LUER	239	POOLE CANNULA D'ASPIRAZIONE	27	PROCTOSCOPO, CHELSEA-EATON	563
PINZA SGORBIA, STILLE-RUSKIN	239	PORTA AGRAFES	326	PROCTOSCOPO, FANSLER	565
PINZA STOMACALE, LANE	548	PORTACOTONE, FARRELL	203	PROCTOSCOPO, KELLY	563
PINZA STRAPPAGESSI, WOLFF	233	PORTACOTONE, REDA	203	PROCTOSCOPI, MORGAN	565
PINZA TAGLIENTE CIRCOLARE	432	PORTACOTONE, TOBOLD	203	PROVIDENCE-HOSPITAL, PINZA EMOSTATICA	106
PINZA TAGLIENTE NASALE, KERRISON	428	PORTACOTONE, UCKERMANN	203	PUNTE PER SPECILLI	201
PINZA TAGLIENTE PER DISCHI		PORTAGHI BARRAQUER	216, 217	PUTTI RASPA PER OSSA	294
INTERVERTEBRALI, COLCLOUGH	344/1	PORTAGHI CASTROVIEJO	216		
PINZA TAGLIENTE PER DISCHI INTERVERTREBRALI,		PORTAGHI MICROVASCULAR	210		
FERRIS-SMITH-KERRISON	344, 344/2	PORTAGHI, ADSON	211		
PINZA TAGLIENTE PER LAMINECTOMIA,		PORTAGHI, ARRUGA	214		
CLOWARD	342	PORTAGHI, BABY-OLSEN-HEG	212		
PINZA TAGLIENTE PER LAMINECTOMIA,		PORTAGHI, BABY-WEBSTER	208		
FERRIS-SMITH	343	PORTAGHI, BARRAQUER-TROUTMAN	216		
PINZA TAGLIENTE PER LAMINECTOMIA,		PORTAGHI, BAUMGARTNER	208		
LOVE-GRUENWALD	340	PORTAGHI, BOYNTON	214		
PINZA TAGLIENTE PER LAMINECTOMIA,		PORTAGHI, BOZEMANN	211		
OLDBERG	341	PORTAGHI, BROWN	209		
PINZA TAGLIENTE PER LAMINECTOMIA,		PORTAGHI, CASTROVIEJO	215		
SCHLESINGER	342	PORTAGHI, CASTROVIEJO MICRO	215		
PINZA TAGLIENTE PER LAMINECTOMIA,		PORTAGHI, COLLIER, 12,5CM	208		
SPURLING	340	PORTAGHI, CRILE	213		
PINZA TAGLIENTE PER LAMINECTOMIA,		PORTAGHI, CRILE-MURRAY	209		
WAGNER	343	PORTAGHI, CRILE-WOOD TC	209		
PINZA TAGLIENTE PER LAMINECTOMIA,		PORTAGHI, DE BAKY	210		
CUSHING	340	PORTAGHI, DERF	208		
PINZA TAGLIENTE PER SETTO NASALE,		PORTAGHI, FINOCCHIETTO	211		
CITELLI	430	PORTAGHI, GILLIES	212		
PINZA TIRALINGUA, COLLIN	453	PORTAGHI, HALSEY	208		
PINZA TIRALINGUA, YOUNG	453	PORTAGHI, HALSEY	208		
PINZA TORCIFI, BERRY TC	319	PORTAGHI, HEANEY	210		
PINZA TORCIFI, CORWIN-HEGAR TC	319	PORTAGHI, HOESEL	213		
PINZA TORCIFI, MAYO-HABERISSER TC	319	PORTAGHI, JACOBSON	215		
PINZA ULTRA LIGHT	95	PORTAGHI, KALT-ARRUGA	214		
PINZA UTERINA PER EMOSTASI,		PORTAGHI, KILNER	212		
GREEN-ARMYTAGE	605				

Q

QUERVAIN, ELEVATORE	275
QUINBY, FORBICI GINGIVALI	67
QUIRE, LEVA PER CORPI ESTRANEI	412
QUISLING MARTELLO	271

R

RACCORDO, DI LAVAGGIO	626
RACHOTOMO	267
RADOLF, PINZA PER LACERAZIONE UNGHIE	297
RAGNELL, DIVARICATORE	140
RALK, PERFORATORE A MANO	299
RAMPLEY, PINZA PER MEDICATURA	136
RAMUS, DIVARICATORE	461
RANDALL, CURETTA PER BIOPSIA	587
RANDALL, PINZA PER CALCOLI RENALI	535
RANEY, GRAFFA PER IL CUOIO CAPELLUTO	327
RANEY, PINZA POSA CLIPS	327
RASCHIATOIO CORNEALE, KUHNT	373
RASOJO	49
RASPA NASALE, FOMON TC	445
RASPA NASALE GALLAHER	446
RASPA NASALE, MILLER	444
RASPA NASALE, PEET	446
RASPA NASALE, FOMON	444
RASPA NASALE, JOSEPH	443

RASPA NASALE, JOSEPH (LEWIS)	443	ROUX MINI, DIVARICATORE	140	SCHMIEDEN-TAYLOR, FORBICI PER DURAMADRE	65/1
RASPA NASALE, MALTZ	443	ROUX-BABY, DIVARICATORE	140	SCHNIDT, PINZA PER TONSILLE	467
RASPA NASALE, MALTZ (COTTLE)	444	ROWE, PINZA PER RIPOSIZIONE	459	SCHOENBORN, DIVARICATORE PER TIROIDE	479
RASPA NASALE, WIENER	443	RUBIN, OSTEOTOMO PER SETTO	440	SCHRÖDER CUCCHIAIO UTERINO	595
RASPA PER OSSA	294	RUBIN, PINZA PER SETTO NASALE	428	SCHROEDER(POZZI), PINZA PER ABBASSARE IL COLLO DELL'UTERO	582
RASPA PER OSSA PUTTI	294	RUDD LEGATORE EMORROIDALE	568	SCHUBERT, PINZA PER BIOPSIA	588
RECAMIER, CURETTE UTERINI	597	RUMEL, PINZA EMOSTATICA	117	SCHUKNECHT, COLTELLO	418
RECIPiente CILINDRICO	620	RUMEL-BELMONT, TOURNIQUET	528	SCHULTZE, SALPINGOGRAFO	596
REDA CALAMITA OCULISTICA	395	RUSKIN, PINZA SGORBIA	239	SCHULZE-BERGMANN, SPECOCO RETTALE	560
REDA, COLTELLO FALCATO	435	RUSKIN-LISTON, CESCOIA PER OSSA	241	SCHUMACHER FORBICI PER STERNO	481
REDA, COLTELLO PER AMPUTAZIONE	44	RUSSEL-DAVIS, ABBASSALINGUA	458	SCHUMACHER INSERTO	472
REDA, CURETTA TAGLIANTE	256	RYDEL-SEIFFERT, DIAPASON	404	SCHUMACHER, PINZA PER BIOPSIA	588, 589
REDA, DIAPASON	403	RYDER, PORT'AGHI	210	SCHWEIGGER, PINZA CAPSULARE	391
REDA, DIVARICATORE PER GESSI	232			SCLEROTOMO, GUYTON-LUNDSCGAARD	373
REDA, EXCENTER FORBICI PER BENDAGGI	69/2			SCLEROTOMO, LUNDGAARD	373
REDA, PERFORATORE A MANO	300			SCOVILLE, CURETTA TAGLIANTE	253
REDA, PINZA COPERCHIO	615			SCOVILLE, DIVARICATORE PER LAMINECTOMIA	196
REDA, PINZA DEPILATORIA	395			SCOVILLE, UNCINI PER RADICI DEI NERVI	330
REDA, PINZA PER AFFERRARE INTESTINI	111			SCOVILLE, VALVE	196
REDA, PORTACOTONE	203			SCOVILLE-HAVERFIELD, DIVARICATORE PER LAMINECTOMIA	196
REDA, ROMPILAMETTE	45			SCUDDER, PINZA INTESTINALE	541
REDA, SEGA TAGLIA ANELLI	297			SEBILAU ELEVATORE	275
REDA, SONDA CONDUTTRICE A FORCHETTA	221			SEDILLO, PERIOSTOTOMO	274, 275
REDA, SPECOCO NASALE	423			SEGA ELETTRICA PER GESSI	230
REDA, UNCINO PER LA PELLE	150			SEGA IN FILO D'ACCIAIO, OLIVECRONA	332
REDON, AGO DI GUIDA	207			SEGA NASALE, JOSEPH	446
REES, FACE LIFT FORBICI	73			SEGA OSCILLANTE PER GESSI CON ASPIRAZIONE	231
REGOLO DI METALLO	25			SEGA PER AMPUTAZIONE, BIER	296
REILL, TENAGLIA PER OSSA	248			SEGA PER AMPUTAZIONE, CHARRIERE	296
REINER, COLTELLO PER GESSI	233			SEGA PER AMPUTAZIONE, SATTERLEE	296
REINER, SIRINGA AURICOLARE	407			SEGA PER AUTOPSIA	231/1
RESANO, PINZA INTESTINALE	542			SEGA PER DITA, LANGENBECK	296
RESANO, PINZE	85			SEGA PER GESSI, ENGL	229
RESANO, FORBICI PER CAPSULA	53/2			SEGA TAGLIA ANELLI, REDA	297
RETRATTORE, PERCY	296			SEGA TAGLIA ANELLI, WALTON	297
RETRATTORI INTRAORALI	463/1			SEGA, GIGLI	332
REVERDIN, AGO	220			SEGOND, PINZA PER ISTERECTOMIA	125
REVERDIN, SPATOLA ADDOMINALE E INTESTINALE	143/1			SEGOND-LANDAU, PINZA PER ISTERECTOMIA	125
REYNOLDS, FORBICI PER CHIRURGIA	54			SEIFERT INSERTO	472
REYNOLDS, SUPERCUT FORBICI	72			SELDIN PERIOSTOTOMO	277
RIBBON, SPATOLA ADDOMINALE E INTESTINALE	143			SELLHEIM CUCCHIAIO OSTETRICO	607
RICARD, DIVARICATORE ADDOMINALE	191			SEMB CESCOIA PER OSSA	242
RICHARDSON, DIVARICATORE	142			SEMB PERIOSTOTOMO	278
RICHARDSON-EASTMAN, DIVARICATORE	142			SEMB PINZA PER BRONCHI	491
RICHARDSON-GRIP, DIVARICATORE	142			SEMB PINZA SGORBIA	240
RICHTER-HEATH, PINZA PER AGRAFES	224			SEMB TENAGLIA PER OSSA	243
RIGBY, DIVARICATORE ADDOMINALE	189/2			SEMKEN PINZA ANATOMICA	86
RI-MINI COMBINAZIONE PER DIAGNOSTICA CON ILLUMINAZIONE ALOGENA	17			SEMKEN PINZA CHIRURGICA	86
RITTER-HALLE, DILATATORE PER SENO, FRONTALE	433			SEMM SPECOCO VAGINALE	571
ROBB, SPATOLA	530			SENN-GREEN DIVARICATORE	153
ROBERTS, PINZA EMOSTATICA	117			SENN-MILLER DIVARICATORE	143
ROCHARD, DIVARICATORE ADDOMINALE	186			SEPERATORE PER IL CORPO MANDIBOLARE HARGIS	463/6
ROCHARD SUPPORTO	186			SEPERATORI SAGITTALI SMITH	463/5
ROCHESTER-CARMALT	109			SEPTEMZANGE KNIGHT	425
ROCHESTER-OCHSNER, PINZA EMOSTATICA	108			SERPENTINE PINZA PER BIOPSIA	593
ROCHESTER-PEAN, PINZA EMOSTATICA	108			SERRANODI KRAUSE	433/2
ROEDER, PINZA FISSATELI	132			SERRANODI KRAUSE-VOSS	433/2
ROGER, ELEVATORE PER SETTO	437, 438			SERRANODI PER TONSILLE, BRUENINGS	468
ROGERS, PINZA PER ISTERECTOMIA	127			SERRANODI PER TONSILLE, EVES	468
ROGGE, PINZA PER STERILIZZAZIONE	227			SERRANODI WILDE	433/2
ROLLET, SCALPELLO ESTIRPATORE	374			SET LARINGOSCOPIO FOREGGER	31
ROLLET, UNCINO DIVARICATORE	375			SET LARINGOSCOPIO, MCINTOSH	31
ROMPILAMETTE, CASTROVIEJO	45			SET PER INFERMERIA	609
ROMPILAMETTE, REDA	45			SET PER SUTURA IN ASTUCCIO DI METALLO	225
ROMPILAMETTE, TROUTMAN-CHRIS	45			SET PER TRACHEOTOMIA	478
ROSE, DIVARICATORE	140			SET PER VARICI IN SCATOLA DI METALLO, NABATOFF	201
ROSEN, AGO	419			SEUTIN FORBICI PER BENDAGGI	69/2
ROSEN, CANNULA D'ASPIRAZIONE	338			SEXTON COLTELLO AURICOLARE	408
ROSEN, COLTELLO	418			SFGMOMANOMETRO	5-6, 12
RÖSER-KOENIG, APRIBOCCA	454				
ROUX, DIVARICATORE	139				

S

SAALFELD SCHIACCIACOMEDONI	608
SACHS, DURA DISSETTORE	332
SACHS, UNCINO PER NERVI	329
SAENGER, PINZA PER ABORTO	606
SALPINGOGRAFO, SCHULTZE	596
SANVENERO FORBICI PER CHIRURGIA	54
SAROT, PINZA EMOSTATICA	118
SAROT, PORT'AGHI	211
SATINSKY, FORBICI VASCOLARI	65/2
SATINSKY, PINZA VASCOLARE	491
SATO, DISSETTORE CORNEALE	373
SATTERLEE SEGA PER AMPUTAZIONE	296
SAUERBRUCH, COSTOTOMO	481
SAUERBRUCH, DIVARICATORE	164
SAUERBRUCH, DIVARICATORE	166
SAUERBRUCH, PINZA PER RIFIUTI	227
SAUERBRUCH, PINZA SGORBIA	240
SAWTELL, PINZA PER TONSILLE	467
SAWYER SPECOCO RETTALE	560
SAYRE, ELEVATORE	281
SCAGLIETTI, PINZA SGORBIA	240
SCALP-CONTOUR, DIVARICATORE	169
SCALPELLI	259
SCALPELLO ESTIRPATORE, ROLLET	374
SCALPELLO, PARTSCH	259
SCALPELLO PER SETTO, CINELLI	441
SCALPELLO PER SETTO, COTTLE	440
SCALPELLO PER SETTO, FREER	439
SCALPELLO PER SETTO, SILVER	442
SCALPELLO PER STERNO, LEBSCHE	267
SCALPELLO, ALEXANDER	259
SCALPELLO, BRUNETTI	268
SCALPELLO, HIBBS	265
SCALPELLO, STILLE	260
SCATOLA PER STERILIZZARE AGHI	615
SCATOLA PER STERILIZZARE AGHI	615
SCATOLA PER STRUMENTI	616, 617, 618
SCHAEDEL, PINZA FISSATELI	132
SCHAMBERG, SCHIACCIACOMEDONI	608
SCHEDI, CURETTA TAGLIANTE	251
SCHIEE COLTELLO PER GONIOATOMIA	373
SCHNEIMANN INSERTO	472
SCHERBAK SPECOCO VAGINALE	575
SCHIACCIACOMEDONI, SAALFELD	608
SCHIACCIACOMEDONI, SCHAMBERG	608
SCHIACCIACOMEDONI, UNNA	608
SCHIACCIACOMEDONI, WALTON	608
SCHIACCIATORE PER L'INTESTINO E LO STOMACO, PAYR	549
SCHIMMELBUSCH TAMBURO	622
SCHINK DERMATOMO	49
SCHIOETZ TONOMETRO	394/2
SCHLESINGER PINZA TAGLIANTE PER LAMINECTOMIA	342
SCHMIDEN, PINZA NASALE	427
SCHMID, CANNULA PER IRRIGAZIONE	338
SCHMIEDEN, SPECILLO DI GUIDA SCANALATO	221
SCHMIEDEN-DICK, AGO PER LEGATURE	219

SGORBIA.....	264	SONDA, WORST	381	SPECOLO RETTALE, CZERNY	559	
SGORBIA, PARTSCH.....	259	SONDA, WORST	381	SPECOLO RETTALE, MATHIEU.....	560	
SGORBIA ALEXANDER.....	259	SONDE PER CALCOLI BILIARI, OCHSNER.....	531	SPECOLO RETTALE, PERRAT.....	559	
SGORBIA BRÜNNINGS-LUCAS.....	260	SPATOLA ADDOMINALE.....	144	SPECOLO RETTALE, SIMS.....	559	
SGORBIA, KILLIAN.....	442/1	SPATOLA ADDOMINALE E INTESTINALE LERICHE.....	143/2	SPECOLO RETTALE, SCHULZE-BERG.....	560	
SGORBIA, PER CORPI ESTRANEI, DIX.....	374	SPATOLA ADDOMINALE E INTESTINALE, HABERER.....	143/1	SPECOLO VAGINALE, ALVAUD.....	576	
SGORBIA, PER CORPI ESTRANEI, WALTON.....	374	SPATOLA ADDOMINALE E INTESTINALE, REVERDIN.....	143/1	SPECOLO VAGINALE, BREISKY.....	577	
SGORBIA, PER SETTO FREER.....	442/1	SPATOLA ADDOMINALE E INTESTINALE, RIBBON.....	143	SPECOLO VAGINALE, COLLIN.....	570	
SGORBIA PER SETTO, HAJEK.....	442/1	SPATOLA ADDOMINALE ED INTESTINALE KADER.....	143/1	SPECOLO VAGINALE, COSCO.....	570, 571	
SGORBIA PER SETTO, KILLIAN-CLAUS.....	442/1	SPATOLA ADDOMINALE ED INTESTINALE KÖRTE.....	143/1	SPECOLO VAGINALE, DOYEN.....	574	
SGORBIA WEST.....	442/1	SPATOLA ADDOMINALE ED INTESTINALE KÜMMEL.....	143/2	SPECOLO VAGINALE, FRIEDMANN.....	577	
SGORBIA, COBB.....	262	SPATOLA CEREBRALE CUSHING.....	369	SPECOLO VAGINALE, GRAVE.....	570	
SGORBIA, HIBBS.....	265	SPATOLA CEREBRALE DAVIS.....	337	SPECOLO VAGINALE, JACKSON.....	573	
SGORBIA, LEXER MINI.....	263	SPATOLA CEREBRALE HEIFETZ.....	369	SPECOLO VAGINALE, KALLMORGEN.....	573	
SGORBIA, ZIELKE.....	264	SPATOLA CEREBRALE, CUSHING.....	336	SPECOLO VAGINALE, KRISTELLER.....	572	
SGORBIA, STILLE.....	260	SPATOLA CEREBRALE, OLIVECRONA.....	336	SPECOLO VAGINALE, LANDAU.....	577	
SGORBIÉ.....	259	SPATOLA PER CICLODIALISI HIRSCHMAN.....	379	SPECOLO VAGINALE, O'SULLIVAN-O'CONNOR.....	576	
SHAMBAUGH, UNCINO.....	419	SPATOLA PER CICLODIALISI, ELSCHNIG.....	379	SPECOLO VAGINALE, PEDERSON.....	570	
SHAPLEIGH ANSA AURICOLARE.....	410	SPATOLA PER CICLODIALISI, CASTROVIEJO.....	379	SPECOLO VAGINALE, SEMM.....	571	
SHEA, MICRO FORBICI AURICOLARI.....	413	SPATOLA PER IRIDE, CULLER.....	378	SPECOLO VAGINALE, SIMS.....	573	
SHEEHAN, OSTEOTOMO PER SETTO.....	441	SPATOLA PER IRIDE, WECKER.....	378	SPECOLO VAGINALE, VU-MORE.....	569	
SHEETS, CANNULA PER IRRIGAZIONE.....	394/2	SPATOLA PER PEDICURE.....	612	SPECOLO VAGINALE, SCHERBAK.....	575	
SIEBENMANN CANNULA PER IRRIGAZIONE.....	433	SPATOLA PER POLMONE, ALLISON.....	489	SPENCER FORBICI PER LEGATURE.....	66	
SIEBOLD, FORBICI GINECOLOGICHE.....	62	SPATOLA ROBB.....	530	SPENCER-WELLS PINZA EMOSTATICA.....	109	
SIEGLE, SPECOLO AURICOLARE.....	402	SPATOLA VESCICALE, KOCHER.....	552	SPEZZATORE UNGHIE.....	612/1	
SILVER, DERMATOMO.....	50	SPATOLA VESCICALE, LEGUEU.....	552	SPILLONE PER STERILIZZAZIONE, BUNT.....	227	
SILVER, SCALPELLO PER SETTO.....	442	SPAZZOLA PER UNGHIE.....	611	SPILLONE PER STERILIZZAZIONE, MAYO.....	227	
SIMCOE, CANNULA PER IRRIGAZIONE.....	394	SPECCHIO FRONTALE, ZIEGLER.....	21	SPINAL CURETTA TAGLIENTE.....	253	
SIMON, CUCCHIAIO UTERINO.....	594	SPECCHIO LARINGEO.....	473	SPINA-NASALIS DIVARICATORE.....	461	
SIMON, DIVARICATORE.....	164	SPECCHIO LARINGEO, MICHEL.....	423	SPRATT, CURETTA TAGLIENTE.....	251	
SIMPSON, FORCIPE.....	602	SPECILLO DI GUIDA SCANALATO KIRSCHNER.....	221	SPURLING PINZA TAGLIENTE PER LAMINECTOMIA.....	340	
SIMPSON-BRAUN, FORCIPE.....	602	SPECILLO DI GUIDA SCANALATO KÖNIG.....	221	SPUTACCHIERA.....	621	
SIMPSON-LUIKART, FORCIPE.....	603	SPECILLO DI GUIDA SCANALATO, BRUNNER.....	221/1	ST CLAIR-THOMSON, COLTELLO ADENOIDE.....	450	
SIMS, CURETTE UTERINI.....	597, 598	SPECILLO DI GUIDA SCANALATO, PAYR.....	221	ST MARKS, DIVARICATORE PELVICO.....	165	
SIMS, DEPRESSORE UTERINO.....	586	SPECILLO DI GUIDA SCANALATO, SCHMIEDEN.....	221	ST MARTIN, PINZA PER SUTURA.....	392	
SIMS, FORBICI GINECOLOGICHE.....	62	SPECILLO FOGLIA MIRTE.....	199	STANDARD FORBICI PER CHIRURGIA.....	51	
SIMS, ISTEROMETRO.....	586	SPECILLO PER CANALE LACRIMALE BOWMAN.....	381	STAUDE-MOORE, PINZA PER ABBASSARE IL COLLO DELL'UTERO.....	582	
SIMS, SPECOLO RETTALE.....	559	SPECILLO PER FISTOLE LOCKHART-MUMMERY.....	200	STEINMANN, CHIODI.....	307, 308	
SIMS, SPECOLO VAGINALE.....	573	SPECILLO PER FISTOLE, PRATT.....	563	STEINMANN, PINZA PER AFFERRARE TENDINI.....	292	
SIMS-MAIER, PINZA PER MEDICATURA.....	134	SPECILLO SCANALATO.....	199	STELBRINK, PINZA SGORBIA.....	234	
SINGLEY, PINZA PER AFFERRARE TESSUTI.....	88	SPECILLO SCANALATO, BRODIE.....	199	STERNBERG DIVARICATORE PER GUANCE.....	453	
SINSKEY, UNCINO.....	376	SPECILLO SCANALATO, DOYEN.....	199	STETOSCOPIO, ANESTOPHON.....	23	
SINUS, ELEVATORE PER SETTO.....	438	SPECILLO SCANALATO, NELATON.....	199	STETOSCOPIO, DUPLEX.....	23	
SIRINGA, AURICOLARE.....	407	SPECILLO, FISH.....	199	STETOSCOPIO, PINARD.....	23	
SIRINGA, AURICOLARE, REINER.....	407	SPECILLO, WATSON-CHEYNE.....	199	STETOSCOPIO.....	23	
SIRINGA, PER TONSILLE.....	470	SPECOLO AURICOLARE, BOUCHERON.....	399	STEVENS, FORBICI PER OFTALMOLOGIA.....	58	
SISTEMA DI FISSAGGIO.....		SPECOLO AURICOLARE, BRUENINGS.....	401	STEVENS, PINZA PER IRIDE.....	383	
LEYLA.....	368, 368/1, 368/2, 368/3, 368/4	SPECOLO AURICOLARE, GRUBER.....	399	STEVENS, PORTAGHI.....	214	
SISTEMA RETRATTORE.....	188	SPECOLO AURICOLARE, HARTMANN.....	399	STEVENS, SUPERCUT FORBICI.....	72	
SKENE, PINZA PER ABBASSARE IL COLLO DELL'UTERO.....	582	SPECOLO AURICOLARE, POLITZER.....	399	STEVENS, UNCINO PER TENOTOMIA.....	375	
SLS PINZA APPLICATORE CLIPS MICRO.....	524, 525	SPECOLO AURICOLARE, SIEGLE.....	402	STEVENSON, BLEFAROSTATO.....	371	
SLUDER-BALLENGER TONSILLO TOMO.....	470	SPECOLO AURICOLARE, TOYNBEE.....	399	STIEGLITZ, PINZA PER SCHEGGE.....	92	
SMELLIE PERFORATORE.....	607	SPECOLO LATERALE.....	569	STILLE, CESOIA PER GESSI.....	229	
SMELLIE UNCINO.....	605	SPECOLO NASALE HARTMANN.....	422	STILLE, COSTOTOMO.....	480	
SMILLIE, COLTELLO PER MENISCO.....	292	SPECOLO NASALE REDA.....	423	STILLE, OSTEOTOMO.....	260	
SMILLIE, ELEVATORE PER OSSA.....	291	SPECOLO NASALE, COTTLE.....	423	STILLE, PINZA ANATOMICA.....	811	
SMITH, SEPARATORI SAGITTALI.....	463/5	SPECOLO NASALE, HARTMANN-HALLE.....	421	STILLE, PINZA CHIRURGICA.....	811	
SMITH US ARMY, FORBICI PER BENDAGGI.....	691/1	SPECOLO NASALE, KILLIAN.....	423	STILLE, PINZA EMOSTATICA.....	122	
SMITH-BUIE, DIVARICATORE ANALE.....	561	SPECOLO NASALE, MOD VIENNA.....	421	STILLE, SCALPELLO.....	260	
SMITH-PETERSEN, OSTEOTOMO.....	261	SPECOLO NASALE, THUDICHUM.....	421	STILLE, SGORBIA.....	260	
SMITH-PETERSEN, PINZA SGORBIA.....	238	SPECOLO NASALE, TIECK-HALLE.....	423	STILLE-BARRAYA, PINZA VASCOLARE.....	88	
SMITHWICK, PINZA POSA CLIPS.....	326	SPECOLO NASALE, VIENNA.....	421	STILLE-HORSLEY, CESOIA PER OSSA.....	242	
SMITHWICK, UNCINO PER NERVI.....	329	SPECOLO NASALE, TIECK-HALLE.....	423	STILLE-LISTON, CESOIA PER OSSA.....	242	
SNELLEN, ANSA PER CATERATTA.....	378	SPECOLO NASALE, VOLTOLINI.....	421	STILLE-LUER, PINZA SGORBIA.....	239	
SNELLEN, PINZA PER ROVESCARE PALPEBRE.....	393	SPECOLO NASALE, HILL-FERGUSON.....	560	STILLE-RUSKIN, PINZA SGORBIA.....	239	
SOMER PINZA PER AFFERRARE L'UTERO.....	585	SPECOLO RETTALE HILL-FERGUSON.....	560	STOCKMANN, PINZA SERRAPENE.....	553/1	
SONDA BOTTUNUTA, JACOBSON.....	335	SPECOLO RETTALE SAWYER.....	561	STONE-WATT, COMPRESSORE.....	545	
SONDA CONDUITTRICE A FORCHETTA.....	475	SPECOLO RETTALE, ALAN-PARKS.....	561	STRANDELL-STILLE, DIVARICATORE.....	157	
SONDA CONDUITTRICE A FORCHETTA, REDA.....	221	SPECOLO RETTALE, BARR.....	559	STRATTE, PORTAGHI.....	212	
SONDA PER CALCOLI BILIARI, DESJARDINS.....	532	SPECOLO RETTALE, BODENHAMMER.....	559	STRAUSS, PINZA SERRAPENE.....	553/1	
SONDA PER CALCOLI BILIARI, MOYNIHAN.....	532			STRINGER.....	228	
SONDA PER CALCOLI BILIARI, MAYO.....	534			STRUEMPEL, PINZA PER CORPI ESTRANEI.....	412	
SONDA PER GOZZO, KOCHER.....	479					

STRULLY FORBICI PER NEUROCHIRURGIA.....	65
STRUMENTI PER CORPI ESTRANEI, DIX	380
STRUMENTO CURA DELLO.....	626
STRUMENTO PER CIRCONCISIONE	556
STRUMENTO PER MISURE	594
STRUMENTO PER VARICI, VARADY	202
STRUMENTO TENDIFILI, DEMEL.....	315
STRUMENTO TENDIFILI, LOUTE	315
STRUYCKEN PINZA NASALE	427
STUOIA IN SILICONE.....	616
SUPERCUT FORBICI	71
SUPERCUT FORBICI IRIS	72
SUPERCUT FORBICI KILNER	72
SUPERCUT FORBICI LISTER	72
SUPERCUT FORBICI REYNOLDS	72
SUPERCUT FORBICI STEVENS	72
SUPERCUT FORBICI WAGNER	72
SUPERCUTFORBICI MAYO	71
SUPERCUTFORBICI MAYO-STILLE	71
SUPERCUTFORBICI METZENBAUM	71
SUPERCUTFORBICI, BABY METZENBAUM	71
SUPPORTO PER PETTO NEGUS.....	459
SUPPORTO PER STERILIZZAZIONE	
FILI KIRSCHNER.....	305
SUPPORTO PER TUBO.....	188
SUPPORTO TORACICO, LEWY	37
SUPPORTO UNIVERSALE PER DIVARICATORI	188
SUPPORTO UNIVERSALE PER ENDOSCOPIO	188
SUPPORTO, ROCHARD	186
SYSTRUNK FORBICI PER CHIRURGIA	66

T

TABB COLTELLO	418
TAKAHASHI, PINZA NASALE.....	427
TAMBURO, SCHIMMELBUSCH.....	622
TAMPONATORE, LUNIATSCHEK	465
TARNIER, FORCIPE.....	604
TAYLOR - USA, MARTELLO DA PERCUSSIONE	24
TAYLOR, DIVARICATORE SPINALE	291
TAYLOR, PINZA CHIRURGICA	87
TC FORBICI PER CHIRURGIA FINE, REYNOLDS TC	54
TC FORBICI PER CHIRURGIA STANDARD	51
TC PINZA, ANATOMICA	81
TC PINZA, CHIRURGICA	81
TC PINZA, CUSHING	83
TC PINZA, CUSHING TAYLOR.....	87
TC PINZA, GILLIES	86
TC PINZA, SEMKEN.....	86
TC PINZA, WANGENSTEEN	89
TEALE, PINZA PER ABBASSARE IL COLLO DELL'UTERO.....	583
TEBBETS, DIVARICATORE PER CHIRURGIA PLASTICA	197
TELAIO METALLICO, MCKESSON.....	454/1
TELAIO PIEGABILE KIRSCHNER	187
TENAGLIA PER OSSA	247
TENAGLIA PER OSSA	249
TENAGLIA PER OSSA BIRCHER-GANSKE.....	246
TENAGLIA PER OSSA, ADSON	298
TENAGLIA PER OSSA, DINGMANN	246
TENAGLIA PER OSSA, FARABEUF	243
TENAGLIA PER OSSA, FARABEUF-L.....	243
TENAGLIA PER OSSA, FERGUSSON	243
TENAGLIA PER OSSA, KERN	244
TENAGLIA PER OSSA, LAMBOTTE	244
TENAGLIA PER OSSA, LANE	244
TENAGLIA PER OSSA, LANGENBECK	243
TENAGLIA PER OSSA, LEWIN	246
TENAGLIA PER OSSA, MARTIN	246
TENAGLIA PER OSSA, REILL	248
TENAGLIA PER OSSA, SEMB	243
TENAGLIA PER OSSA, ULRICH	248
TENAGLIA PER OSSA, VAN BUREN.....	249

TENAGLIA PER OSSA, VERBRUGGE	245
TENAGLIE TAGLIAFILII	317, 318
TERRIER, PINZE EMOSTATICHE	106
TERSON, PINZA CAPSULARE	391
TESSIER, DIVARICATORE	463/3
THOMAS, CURETTE UTERINI	599
THOMAS-GAYLOR, PINZA PER BIOPSIA	588
THOMS-ALLIS, PINZA PER AFFERRARE	
INTESTINI	538
THOMSON-WALKER, DIVARICATORE VESCICALE	552
THOREK, FORBICI TORACALI	65/2
THUDICHUM SPECOLO NASALE	421
TIECK-HALLE, SPECOLO NASALE.....	423
TILLEY, PINZA AURICOLARE	411
TIRAMIOMI, DOYEN.....	594
TIRAVENE	202
TISCHLER, PINZA PER BIOPSIA	591
TISCHLER-KEVORKIAN, PINZA PER BIOPSIA	592
TISCHLER-MORGAN, PINZA PER BIOPSIA	590, 591
TITAN, PINZA EMOSTATICA, CRILE	107
TITAN, PINZA EMOSTATICA, KELLY,	106
TOBOLD, ABBASSALINGUA	453
TOBOLD, PORTACOTONE	203
TOENNIS DURA, DISSETTORE	332
TOENNIS, PINZA EMOSTATICA	117
TOENNIS-ADSON, FORBICI PER NEUROCHIRURGIA	65
TOGLILAMA	42
TOHUKU, PINZA FISSATELI	132
TONOMETRO, SCHIOETZ.....	394/2
TONSILLOTOMO, SLUDER-BALLENGER	470
TONSILLOTOMO, TYDING	469
TOOK DISSETTORE CORNEALE	373
TOURNIQUET, RUMEL-BELMONT	528
TOWNSEND, MANICO SOLO.....	591
TOWNSEND, PINZA PER BIOPSIA	591
TOYNBEE, SPECOLO AURICOLARE	399
TRASFORMATORE RICARICA BATTERIA	34
TRATTORE, BILL	604
TRATTORE, LUIKART-BILL	604
TRAVERS DIVARICATORE	172
TREFINA CUTANEA, KEYES.....	608
TREQUARTO PER SENO MASCELLARE, COAKLEY.....	204
TREQUARTO PER SENO MASCELLARE, LICHTWITZ	204
TREQUARTO PER SENO MASCELLARE, PIERCE	204
TREQUARTO PER SINOSCOPIA	205
TREQUARTO PER SINOSCOPIA	205
TREQUARTO, NELSON	205
TREQUARTO, OCHSNER	205
TREQUARTO, UNIVERSAL	204
TREQUARTO, STANDARD (NELSON)	204
TROELTSCH, PINZA AURICOLARE	424
TROEMNER PERKUSSIONSMARTELLO	24
TRONCHESINA PER PELLE	610
TRONCHESINA PER UNGHIE	612/1, 613
TRONCHESINA PER UNGHIE ANVIL	613
TRONCHESINA PER UNGHIE, TURNBULL	609
TROUSSEAU, DILATATORE TRACHEALE	476
TROUSSEAU-BABY, DILATATORE TRACHEALE	476
TROUTMAN, PINZA PER IRIDE	389
TROUTMAN-CHRIS, ROMPILAMETTE	45
TUBBS, DILATATORE	528
TÜBINGEN, PINZA PER FILO	392
TUBO DI PROLUNGAMENTO, BRUENINGS	472
TUBULUS, GERADE, EINFACH.....	267
TUFFIER DIVARICATORE	147
TUFFIER DIVARICATORE COSTALE	487
TUFFIER PINZA PER AFFERRARE TESSUTI	110
TURNBULL TRONCHESINA PER UNGHIE	609
TYDING, PINZA PER TONSILLE	467, 468
TYDING, TONSILLOTOMO	469

U

UCKERMANN PORTACOTONE	203
ULRICH, PINZA PER MEDICATURA.....	135
ULRICH, TENAGLIA PER OSSA	248
ULTRA-LIGHT-PINZA, ATRAUTMATIC	95
UNCINI PER NERVI E DIVARICATORI FINI LAHEY	149
UNCINO ACUTO LAHEY.....	149
UNCINO DI FISSAZIONE, BURCH	373
UNCINO DIVARICATORE, KNAPP	375
UNCINO DIVARICATORE, ROLLET	375
UNCINO ESTRATTORE.....	322
UNCINO GALEA, YASARGIL	330
UNCINO GASS	376
UNCINO KUGLEN	376
UNCINO NASALE AUFRICHT	447
UNCINO NASALE CONVERSE	448
UNCINO NASALE UNCINO.....	447
UNCINO NASALE, COTTLE	447
UNCINO NASALE, MASING-NEIVERT	447
UNCINO PER DURA MADRE, JACOBSON	335
UNCINO PER DURAMADRE	335
UNCINO PER DURAMADRE, ADSON	329
UNCINO PER FISTOLE, EMMETT	594
UNCINO PER IL STRABISMO, GRAEFE	375
UNCINO PER IL STRABISMO, GREEN	375
UNCINO PER IL STRABISMO, JAMESON	375
UNCINO PER IRIDE, O'CONNOR	375
UNCINO PER IRIDE, WIENER	375
UNCINO PER LA PELLE, GRAEFE	149
UNCINO PER LA PELLE, COTTLE-NEIVERT	448
UNCINO PER LA PELLE, FOMON	447/1
UNCINO PER LA PELLE, FRAZIER	149
UNCINO PER LA PELLE, FREER	448
UNCINO PER LA PELLE, GILLIES	448
UNCINO PER LA PELLE, GUTHRIE	149
UNCINO PER LA PELLE, JOSEPH	149
UNCINO PER LA PELLE, KILNER	608
UNCINO PER LA PELLE, KLEINERT-KUTZ	149
UNCINO PER LA PELLE, REDA	150
UNCINO PER LE PINNE NASALI LANGE	448
UNCINO PER MUSCOLI	267
UNCINO PER NERVI D'ERRICO	329/2
UNCINO PER NERVI, CRILE	328
UNCINO PER NERVI, CUSHING	328
UNCINO PER NERVI, DANDY	328
UNCINO PER NERVI, GRAHAM	329
UNCINO PER NERVI, HESS	329/1
UNCINO PER NERVI, KRAYENBUEHL.....	336
UNCINO PER NERVI, LOVE	329/2
UNCINO PER NERVI, SACHS	329
UNCINO PER NERVI, SMITHWICK.....	329
UNCINO PER RADICI DEI NERVI, HOLSHER	329/1
UNCINO PER RADICI DEI NERVI, LOVE	330
UNCINO PER RADICI DEI NERVI, SCOVILLE	330
UNCINO PER TENOTOMIA, STEVENS	375
UNCINO, SHAMBAUGH	419
UNCINO, SINSKEY	376
UNCINO SPEZZATORE, BRAUN	607
UNCINO, BARBARA	419
UNCINO, DAY	409
UNCINO, FISCH	335
UNCINO, LUCAE	409
UNCINO, MCGEE	419
UNCINO, SMELLIE	605
UNCINO, WAGENER.....	409
UNI I COMBINAZIONE PER DIAGNOSTICA CON ILLUMINAZIONE STANDARD	13
UNI II COMBINAZIONE PER DIAGNOSTICA CON ILLUMINAZIONE STANDARD	14
UNI III COMBINAZIONE PER DIAGNOSTICA CON ILLUMINAZIONE STANDARD	15
UNIVERSAL, FORBICI PER BENDAGGI.....	70
UNIVERSAL, FORBICI PER FILO DI METALLO E	

LAMIERA	67
UNIVERSAL, PINZA PER STERILIZZAZIONE	227
UNIVERSAL, TREQUARTO	204
UNNA SCHIACCIACOMEDONI	608
URETROTOMO OTIS	553
US ARMY DIVARICATORE	141
USA PINZA ANATOMICA	81

V

VACUMENTRO PER VUOTI DI SANGUE	295
VALLEIX ISTEROMETRO	586
VALVE, CON ADATTATORI AL TELAIIO	194
VALVE, SCOVILLE	196
VAN BUREN, CANDELETTA DILATATRICE	554
VAN BUREN, TENAGLIA PER OSSA	249
VAN DOREN, PINZA PER BIOPSIA	588
VANNAS FORBICI OCULISTICHE	79
VARADY, STRUMENTO PER VARICI	202
VASSOIO PER PASTIGLIE	621
VERBRUGGE TENAGLIA PER OSSA	245
VERBRUGGE-MÜLLER, ELEVATORE PER OSSA	286/2
VIENNA, PORTALEGATURE	221/1
VIRCHOW, COLTELLO PER CARTILAGINE E DISSEZIONE	48
VIRTUS(RALK), PINZA PER SCHEGGE	92
VOLKMANN, CURETTA TAGLIENTE	251
VOLKMANN, CURETTA TAGLIENTE	257
VOLKMANN, DIVARICATORE	153
VOLKMANN, DIVARICATORE	154
VOLKMANN, DIVARICATORE	156
VOLTOLINI SPECOCO NASALE	421
VU-MORE SPECOCO VAGINALE	569

W

WACHENFELDT, PINZA PER AGRAFES	224
WADSWORTH-TODD, CAUTERIO	378
WAGENER-MOSHER, CANNULA TRACHEALE	477
WAGNER, UNCINO	409
WAGNER, FORBICI GINGIVALI	67
WAGNER, PINZA TAGLIENTE PER LAMINECTOMIA	343
WAGNER, SUPERCUT FORBICI	72
WALLICH, CUCCHIAIO PER ABORTO	607
WALSHAM, PINZA PER RADDRIZZARE IL SETTO NASALE	449
WALTON, SCHIACCIACOMEDONI	608
WALTON, SEGA TAGLIA ANELLI	297
WALTON, SGORBIA PER CORPI ESTRANEI	374
WANGENSTEEN, PINZA VASCOLARE	89
WANGENSTEEN, PORT'AGHI	210
WARTENBERG ALGESIMETRO	25
WATSON, DERMATOMO	50
WATSON-CHEYNE, ELEVATORE	283
WATSON-CHEYNE, SPECILLO	199
WATSON-WILLIAMS, PINZA NASALE	428
WAUGH PINZA, CHIRURGICA	83
WEBER, ANSA PER CATERATTA	378
WEBER, PINZA PER AORTA	501
WEBSTER, PORT'AGHI	208
WECKER, FORBICI OCULISTICHE	75
WECKER, SPATOLA PER IRIDE	378
WEEK, BLEFAROSTATO	370
WEIL-BLAKESLEY, PINZA NASALE	426
WEITLANER, DIVARICATORE	169
WEITLANER-WULLSTEIN, DIVARICATORE	169
WELLER, FORBICI PER DISSEZIONE	53/2
WELLS, CUCCHIAIO PER ENUCLEAZIONE	378
WERTHEIM, FORBICI PER ISTERECTOMIA	63
WERTHEIM, PINZA PER ISTERECTOMIA	124
WERTHEIM, PINZA PER ISTERECTOMIA	128
WERTHEIM-CULLEN, PINZA PER PEDUNCOLO RENALE	125
WESTCOTT, FORBICI OCULISTICHE	75

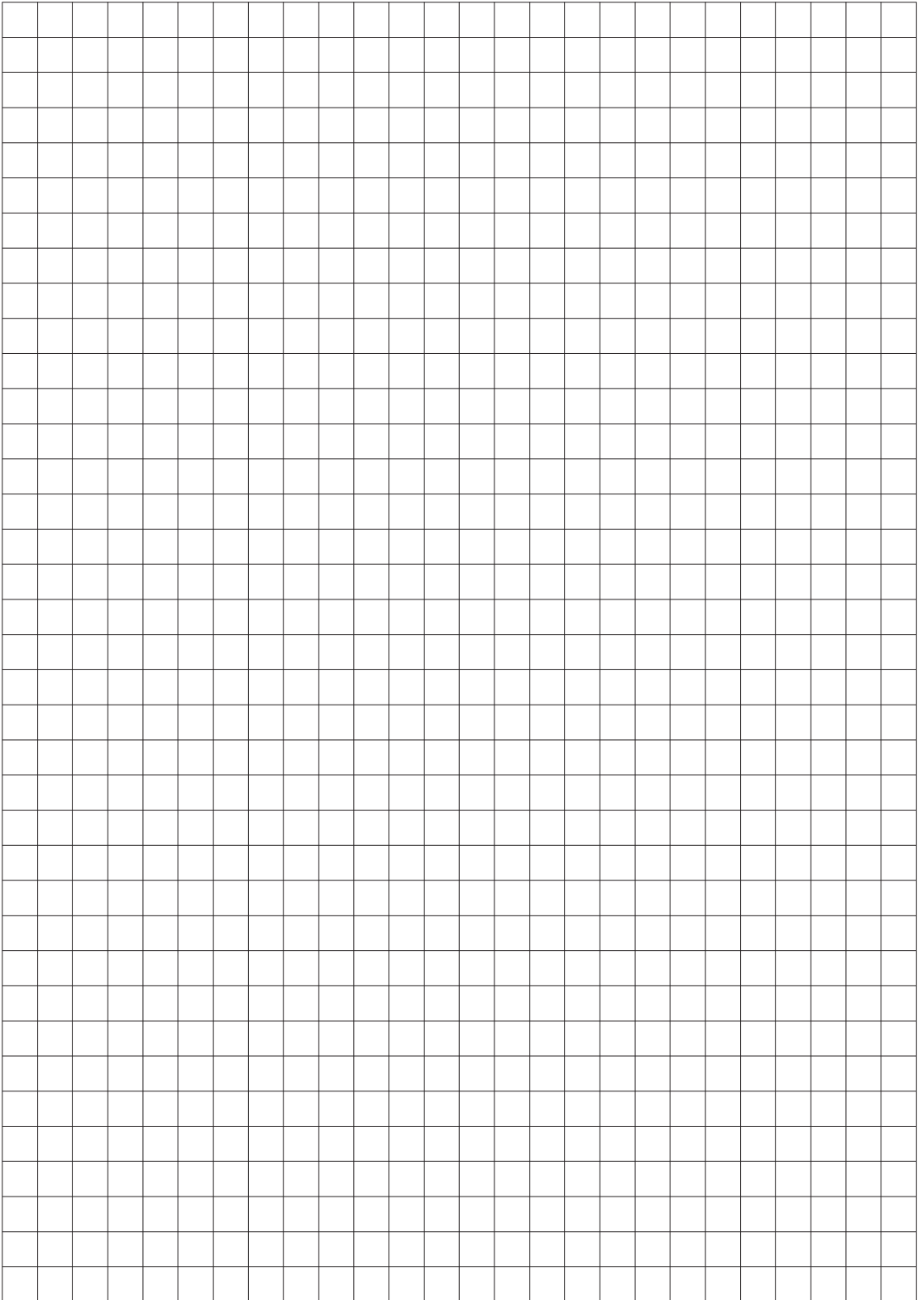
WESTMACOTT, PINZA NASALE PER TAMPONI	424
WHEELER COLTELLO LANCEOLARE	373
WHITE, PINZA PER TONSILLE	467
WIEDER, ABBASSALINGUA	452
WIENER, RASPA NASALE	443
WIENER, UNCINO PER IRIDE	375
WIGMORE, COLTELLO PER GESSI	229
WIKSTROEM, PINZA EMOSTATICA	117
WILDE, SERRANODI	411
WILDE, SERRANODI	433/2
WILDE(TROELTSCH), PINZA AURICOLARE	410
WILDER, ANSA PER CATERATTA	378
WILLET MARTEL, PINZA DA PRESA	110
WILLIAMS, BLEFAROSTATO	370
WILLIAMS, CACCIAVITE	323
WILLIAMS, PINZA PER AFFERRARE INTESTINI	539
WILLIGER, CURETTA TAGLIENTE	255
WILLIGER, MARTELLO	271
WILLIGER, PERIOSTOTOMO	276
WINTER, PINZA PER ABORTO	606
WITTMER, PINZA PER BIOPSIA	589
WOLFF, PINZA STRAPPAGESSI	233
WOODSON DURA, DISSETTORE	333
WORST, SONDA	381
WRIGLEY, FORCIPE	602
WULLSTEIN, COLTELLO	418
WULLSTEIN, DIVARICATORE	171
WULLSTEIN, MANICO D'ASPIRAZIONE	338
WULLSTEIN, MICRO PINZA AURICOLARE A CUCCHIAIO	416

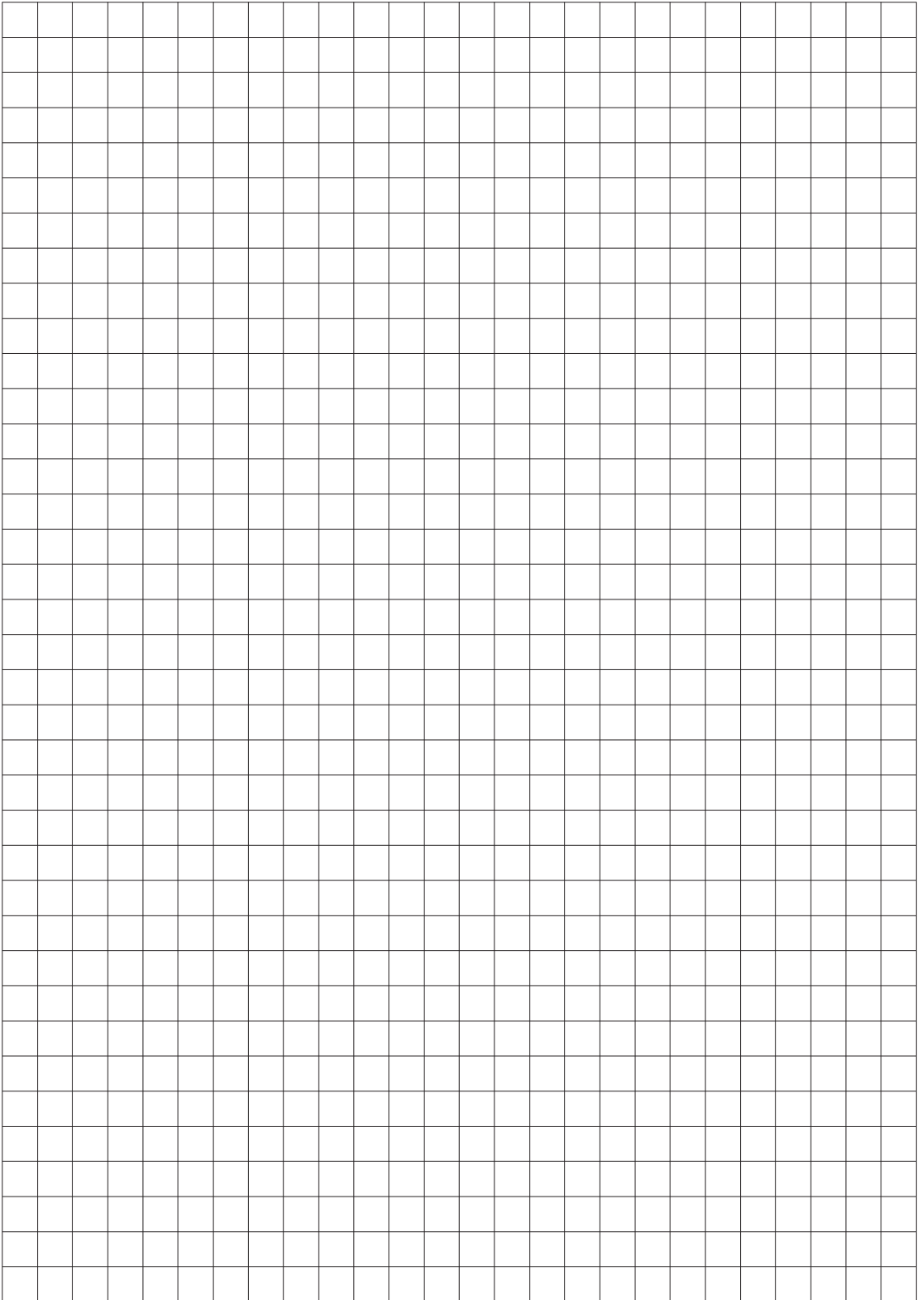
Y

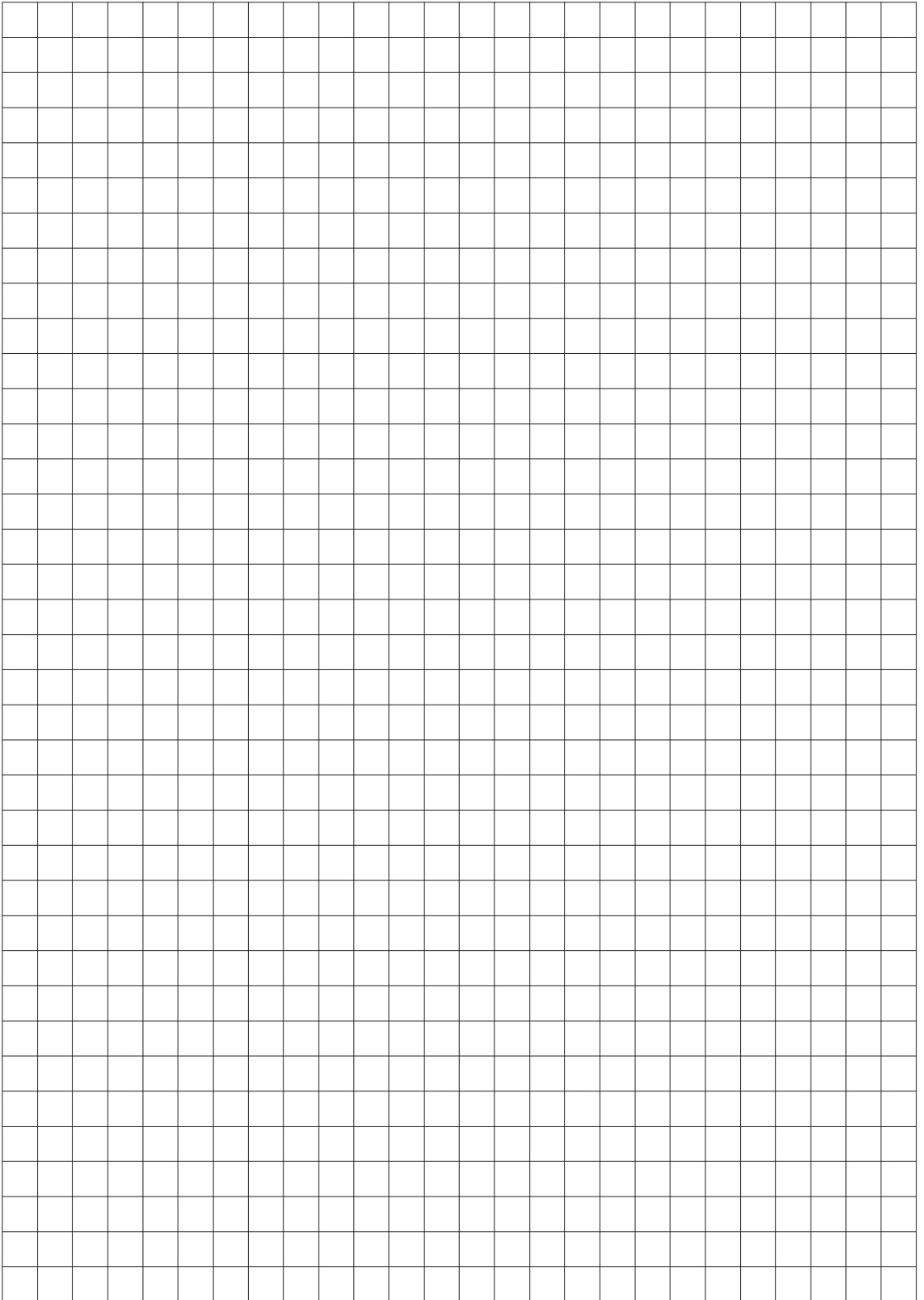
YANCOSKIE, DIVARICATORE PER CHIRURGIA PLASTICA	198
YASARGIL, CANNULA D'ASPIRAZIONE	337/2
YASARGIL, PINZA PER TUMORI	97
YASARGIL, UNCINO GALEA	330
YEOMAN, PINZA INTESTINALE PER BIOPSIA	566
YOUNG, DIVARICATORE PER LA PROSTATA	550
YOUNG, PINZA TIRALINGUA	453

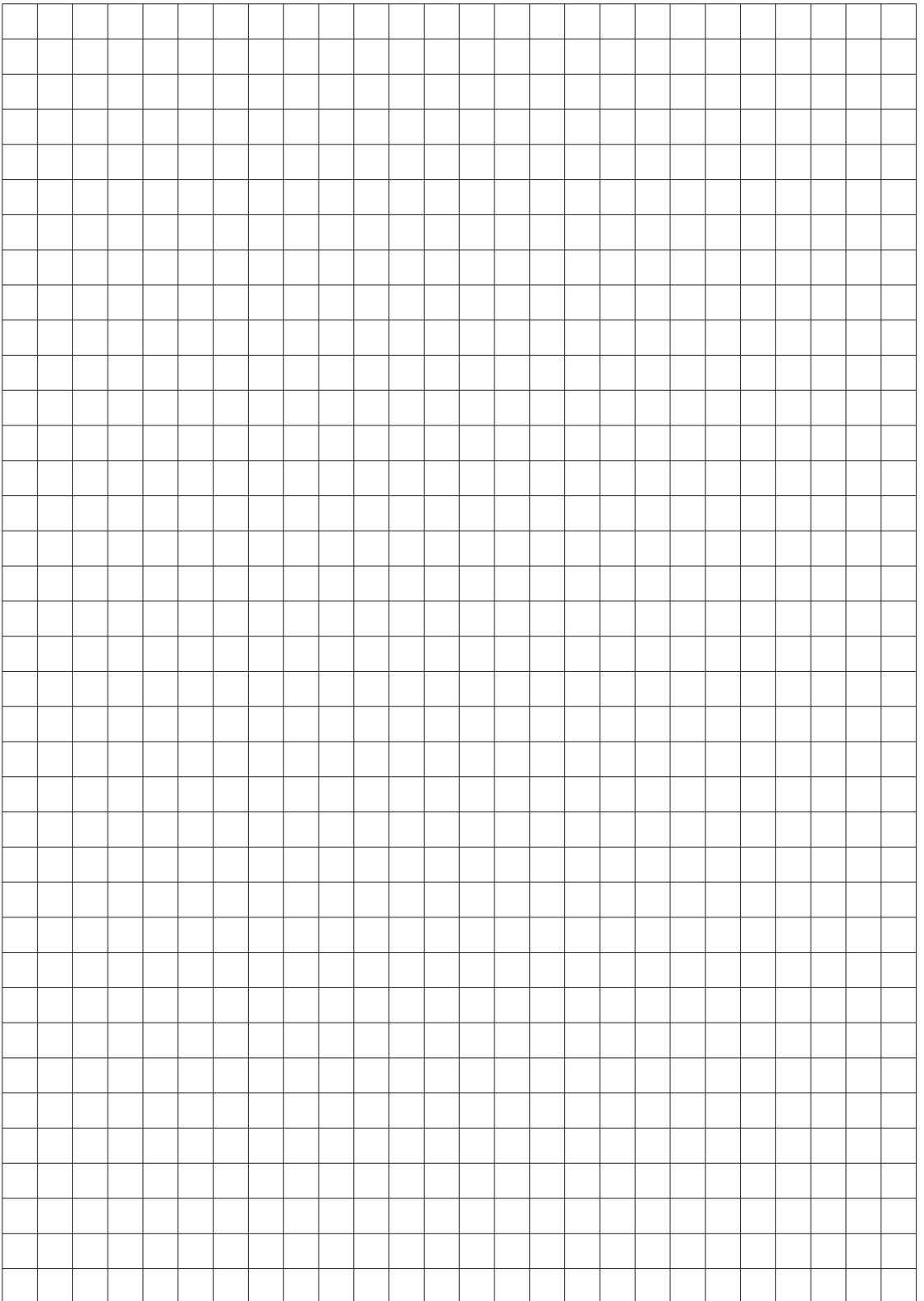
Z

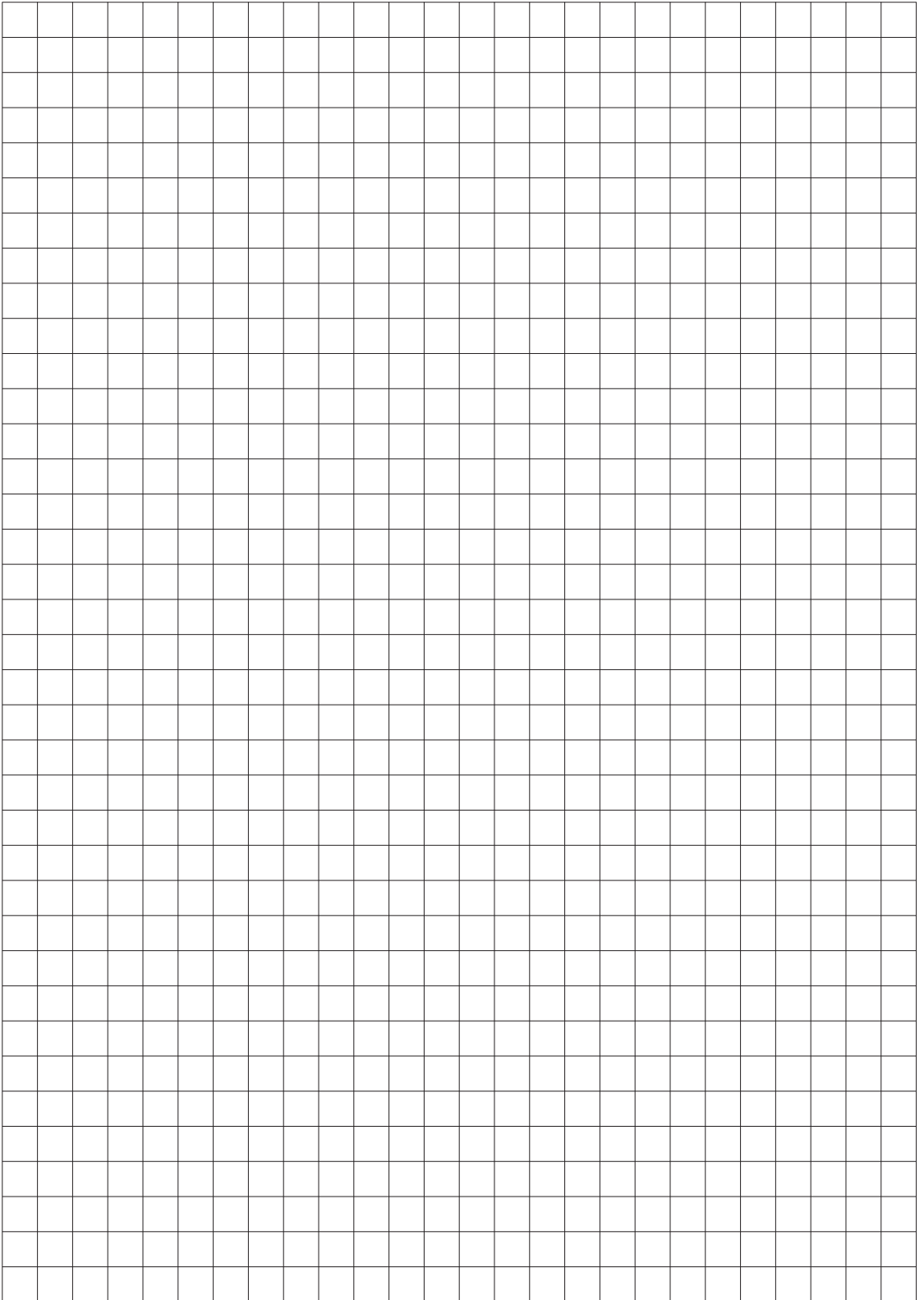
ZAUFAL, ELEVATORE AURICOLARE	409
ZAUFAL-JANSEN, ELEVATORE AURICOLARE	409
ZAUFAL-JANSEN, PINZA SGORBIA	238
ZENKER, DIVARICATORE	161
ZENKER, PINZA EMOSTATICA	118
ZIEGLER, COLTELLO LANCEOLARE	373
ZIEGLER, COLTELLO PER IRIDE	372
ZIEGLER, SPECCHIO FRONTALE	21
ZIELKE, SGORBIA	264
ZÖLLNER, CANNULA D'ASPIRAZIONE	337/2













Weitere Kataloge und Prospekte
Other cataloges and prospects

HNO / Sinuskopie
ENT / Sinuscopy

Sterilisations Behälter
Sterilization Container System

Endoskopie
Endoscopy

Urologie / Arthroskopie
Urology / Arthroscopy

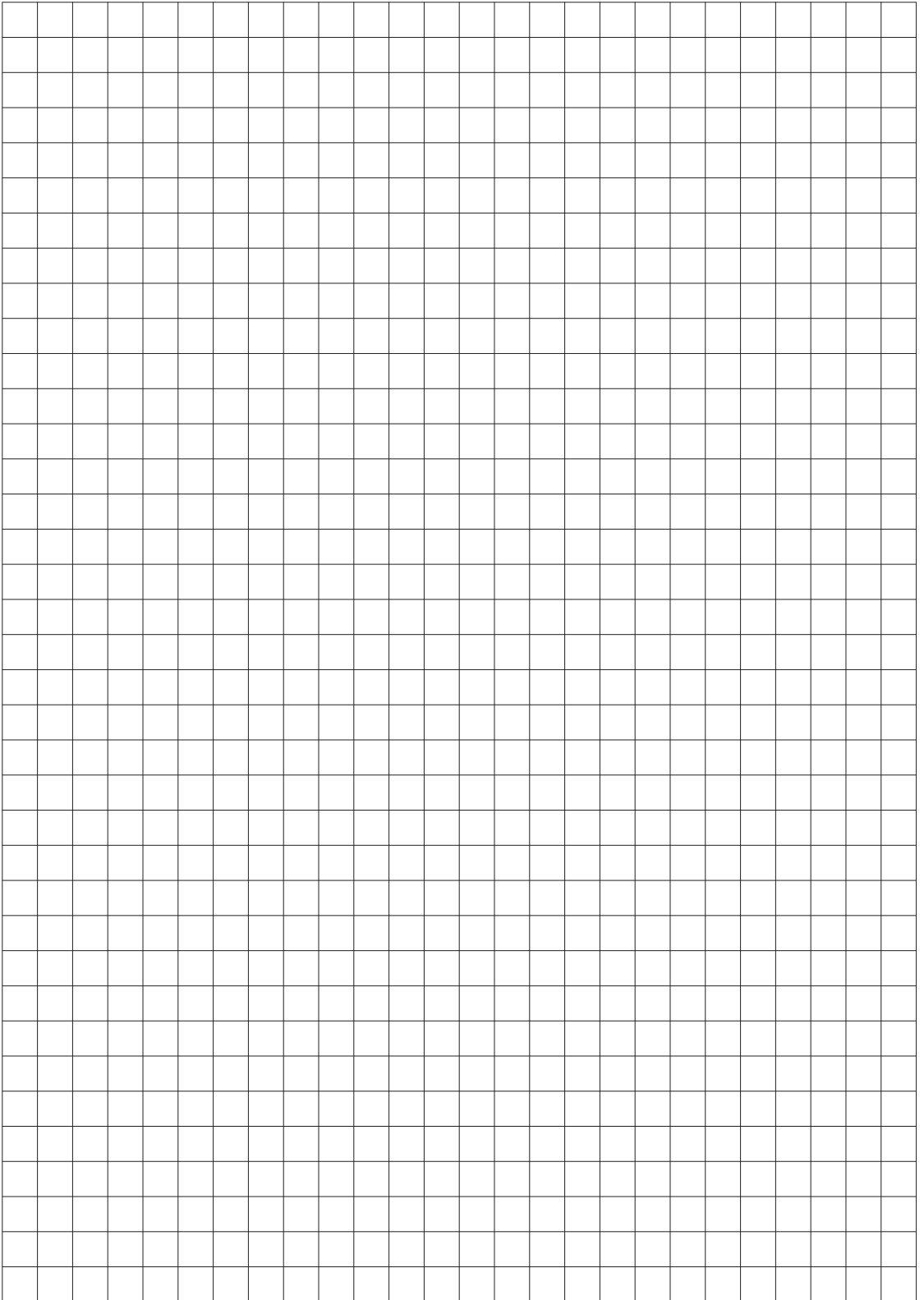
Plastische Chirurgie
Plastic surgery

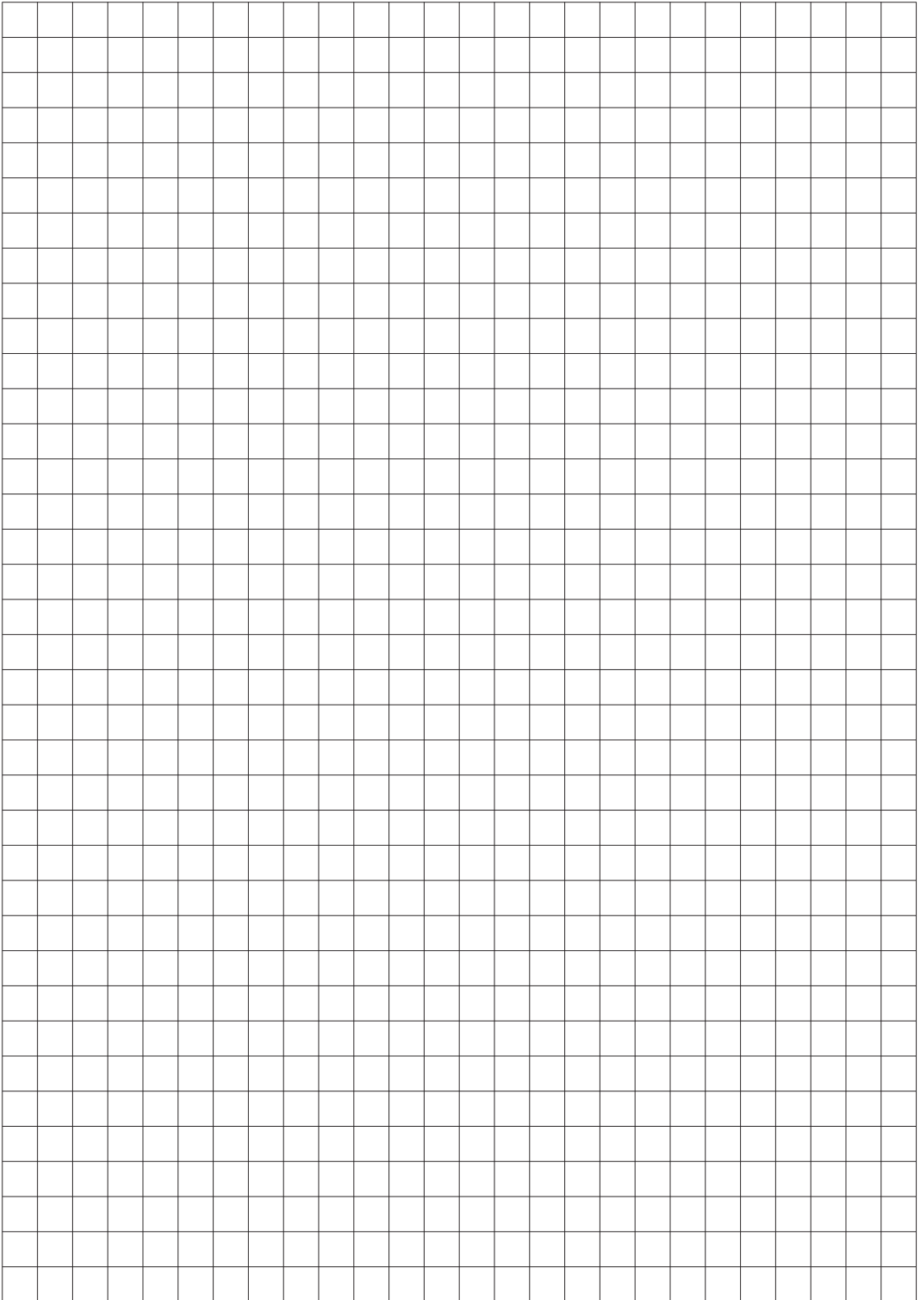
Orthopädie
Orthopedic

Titan Instrumente
Titanium Instruments

Neurochirurgie
Neurosurgery

REDA Instrumente GmbH
Gänsäcker 34, D-78532 Tuttlingen
Tel: 0049 (0) 7462 9445 0
Email: info@reda-instrumente.de
Web: www.reda-instrument.de





ALLGEMEINCHIRURGIE
GENERAL SURGERY
CIRUGÍA GENERAL
CHIRURGIA GENERALE





INSTRUMENTE GMBH

Weitere Kataloge und Prospekte
Other cataloges and prospects

HNO / Sinuskopie
ENT / Sinuscopy

Sterilisations Behälter
Sterilization Container System

Endoskopie
Endoscopy

Urologie / Arthroskopie
Urology / Arthroscopy

Plastische Chirurgie
Plastic surgery

Orthopädie
Orthopedic

Titan Instrumente
Titanium Instruments

Neurochirurgie
Neurosurgery

REDA Instrumente GmbH
Gänsäcker 34, D-78532 Tuttlingen
Tel: 0049 (0) 7462 9445 0
Email: info@reda-instrumente.de
Web: www.reda-instrument.de